

Energy Efficient Homes in Louisiana



Louisiana Department of Natural
Resources

May 2010

Scott A. Angelle, Secretary
T. Michael French, Director
Paula Ridgeway, Manager

Principal Authors

James E. Davidson, Sr., CSI

Jerry Heinberg, AIA, NCARB

Billy Williamson, EIT, EMIT

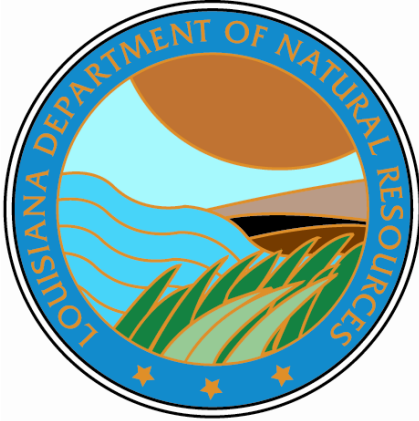

Project Manager

David McGee, PE, CEM

Technical Review

Howard Hershberg, AIA

David McGee, PE, CEM

Graphics and Layout

James E. Davidson, Sr., CSI

Jerry Heinberg, AIA, NCARB

Billy Williamson, EIT, EMIT

Contact

For more information on any of the energy services mentioned in this guide, please contact:

Technology Assessment Division:

Main Number: 225-342-1399

Toll-free: 1-800-836-9589

Fax: 225-342-1397

E-mail: energy@dnr.state.la.us

Website: <http://www.dnr.state.la.us/energy>

The contents of this manual are offered as guidance. The Louisiana Department of Natural Resources, nor any of its employees, nor any of its contractors, subcontractors, or their employees, and all technical sources referenced in this manual do not (a) make any warranty or representation, express or implied, with respect to the accuracy, completeness, or usefulness of the information contained in this report, or that the use of any information, apparatus, method or process disclosed in this report may not infringe privately owned rights; (b) assume any liabilities with respect to the use of, or for damages resulting from the use of any information, apparatus, method, or process disclosed in this report. This report does not reflect official views or policy of the above mentioned institutions. Mention of trade names or commercial products does not constitute endorsement or recommendation for use.

This page left intentionally blank.

Table of Contents

Table of Figures	iii
Table of Tables	v
Preface	ix
1. Site Planning	1
Changing Times – Professional Advice	1
Surveys	1
Location and Size	2
Drainage	2
Earthwork	2
Views and Access	3
Understanding Solar Position	3
Natural Cooling	4
Natural Ventilation	6
Landscaping and Trees	10
2. The House as a System	13
Concepts	14
Systems in a Home	21
Systems are Interdependent	29
3. Energy Efficient Features	31
Achieving Energy Efficiency	31
Appendix – Energy Star Homes Technical Resources	47
4. Air Leakage Sealing - Materials and Techniques	53
Air Leakage Driving Forces	54
Materials	58
Seal Penetrations and Bypasses	58
Airtight Drywall Method	64
Housewrap Air Barriers	67
5. Insulation Materials and Techniques	73
Insulation Materials	73
Foundation Insulation	77
Basement Wall Insulation	78
Framed Floor Insulation	81
Wall Construction	85
Ceilings and Roofs	98

6. <i>Windows and Doors</i>	109
Windows_____	109
Doors_____	121
Overall Window and Door Recommendations_____	122
7. <i>Heating, Ventilation, and Air Conditioning</i>	123
Types of HVAC Systems_____	123
Air Conditioning Equipment_____	126
Heating Systems_____	129
Ventilation and Indoor Air Quality_____	137
Overall HVAC Recommendations_____	142
8. <i>Duct Design and Sealing</i>	143
Duct Materials_____	143
The Problem of Duct Leakage_____	144
Duct Design_____	151
Conclusion_____	157
9. <i>Water Heating, Appliances and Lighting</i>	159
Water Heating_____	159
Appliances_____	165
Lighting_____	168
10. <i>Energy Efficient Roofing</i>	173
The Roof Structure (A Good Foundation!)_____	173
Green Roofs_____	184
11. <i>Fingertip Facts</i>	187
Abbreviations_____	187
Energy and Fuel Data_____	187
Average Daily Solar Radiation_____	187
Insulating Values_____	188
HVAC Equipment Efficiencies_____	189
Climatic Data for Louisiana_____	189

Table of Tables

1. Site Planning	
Table 1-1 Shading Design Strategies_____	10
2. The House as a System	
Table 2-1 Building Materials and Their Perm Ratings_____	28
3. Energy Efficient Features	
Table 3-1 Estimated Extra Costs of an Energy Star Home in Baton Rouge_____	36
Table 3-2 Energy Savings for an Energy Star Home_____	37
Table 3-3 Design Requirements to Meet the 2006 International Residential Code_____	37
Table 3-4 Rate of Return for Energy Investments (%)_____	39
Table 3-5 Mortgage Rate Table by Interest Rate by Term - \$/S1000_____	40
Table 3-6 IRC 2006 Code and Energy Star Homes for Climate Zones 2 & 3_____	42
Table 3-7 Economic Analysis of Energy Efficient Features_____	43
Table 3-8 Energy Star Mandatory Requirements_____	51
4. Air Leakage Sealing - Materials and Techniques	
Table 4-1 Typical Infiltration Rates_____	57
Table 4-2 Leaks and Sealants_____	59
5. Insulation Materials and Techniques	
Table 5-1 Fiberglass Batt Insulation Characteristics_____	74
Table 5-2 Comparison of Envelope Insulation Materials_____	75
Table 5-3 Cost Comparison of Insulating Materials_____	76
Table 5-4 Economics of Framed Floor Insulation_____	82
Table 5-5 2x4 Framed Wall Problems and Solutions_____	86
Table 5-6 Steel Wall Insulation Options_____	94
Table 5-7 Sheathing Costs_____	96
Table 5-8 Economics of Wall Insulation_____	97
Table 5-9 Typical Attic Insulation Costs (\$/sq.ft.)_____	100
Table 5-10 Typical Blowing Chart for Loose-Fill Insulation_____	100
Table 5-11 Economics of Attic Insulation_____	103
Table 5-12 Economics of Cathedral Ceiling Insulation_____	106
6. Windows and Doors	
Table 6-1 Economics of Energy Conserving Windows and Doors_____	109
Table 6-2 Cost Comparison of Window Alternatives_____	114
Table 6-3 Sample Window Performance Characteristics_____	114
Table 6-4 Summer and Winter Sun Angles_____	119
7. Heating, Ventilation, and Air Conditioning	
No Tables	
8. Duct Design and Sealing	
No Tables	

9. <i>Water Heating, Appliances and Lighting</i>	
Table 9-1 Typical Energy Costs for Appliances	165
Table 9-2 Fluorescent Lighting Guidelines	170
Table 9-3 Purchase and Operating Costs of Incandescent Lamps and CFLs	170
Table 9-4 Sample Improved Lighting Design	171
10. <i>Energy Efficient Roofing</i>	
Table 10-1 Cooling Performance During Unoccupied Period	175
Table 10-2 Normalized Annual Savings & Demand Reductions	175
Table 10-3 Characteristics of Various Metal Roof Types Ranked by Reflectance	180
Table 10-4 Top Rated Membrane Products Typical Properties	182
Table 10-5 Advantages and Disadvantages of Green Roofs	184
11. <i>Fingertip Facts</i>	
Table 11-1 Climatic Data for Louisiana	190
Table 11-2 Average Monthly Temperatures	190
Table 11-3 Comparative Climatic Data	191

Table of Figures

1. Site Planning

Figure 1-1 Solar Path Chart	4
Figure 1-2 Wind Roses Summer and Winter	5
Figure 1-3 Natural Ventilation Design Strategies	6
Figure 1-4 Stack Effect	7
Figure 1-5 Overhang Types	7
Figure 1-6 Site Planning	8
Figure 1-7 Site Planning	9

2. The House as a System

Figure 2-1 Home Losing Heat through Conduction in Winter	14
Figure 2-2 Convection in the Home	15
Figure 2-3 Radiation Entering House	15
Figure 2-4 Air Quality Problems from “Fresh” Air	16
Figure 2-5 Thermal Boundaries	17
Figure 2-6 Conditions for Condensation	17
Figure 2-7 Psychometric Chart	19
Figure 2-8 Winter Dew Point Temperature Inside Walls	19
Figure 2-9 Summer Condensation in Walls	20
Figure 2-10 Relative Humidity Ranges	21
Figure 2-11 Bulk Moisture Transport	23
Figure 2-12 Drainage Plane	24
Figure 2-13 Capillary Action	25
Figure 2-14 Typical Water Vapor Transport	26
Figure 2-15 Drying to the Interior	27

3. Energy Efficient Features

Figure 3-1 International Residential Code (2006) Climate Zone Map	33
Figure 3-2 Envelope Construction Ideas	34
Figure 3-3 Sealing Holes in Framing	34
Figure 3-4 More Sealing Techniques	35
Figure 3-5 Typical Insulated Concrete Forms (ICF)	44
Figure 3-6 Typical Structural Insulated Panel	45

4. Air Leakage Sealing - Materials and Techniques

Figure 4-1 Creating a Pressure Boundary	54
Figure 4-2 Wind Driven Infiltration	55
Figure 4-3 The Stack Effect	55
Figure 4-4 Mechanical System Driven Infiltration	56
Figure 4-5 Blower Door	57
Figure 4-6 Home Blower Door Test	58
Figure 4-7 Air Leakage through Bypass	59
Figure 4-8 Typical Home Air Leakage Sites	60
Figure 4-9 Sealing Bypasses	62
Figure 4-10 Sealing More Bypasses	63
Figure 4-11 Airtight Drywall Method Air Barrier	64
Figure 4-12 Creating an Air Barrier Between Floors	66
Figure 4-13 Housewrap – Window Connection	68
Figure 4-14 Recommended Housewrap Installation Process & Procedure	69
Figure 4-15 Sealing Sheathing as Exterior Air Barrier	70

5. Insulation Materials and Techniques

Figure 5-1 Insulating the Building Envelope Recommended Insulation Values	73
Figure 5-2 Insulating Concrete Block Cores	77
Figure 5-3 Relative Humidity (RH) and Foundation Vents	78
Figure 5-4 Interior Foam Wall Insulation	79
Figure 5-5 Interior Framed Wall	79
Figure 5-6 Insulated Concrete Form Wall Systems	80
Figure 5-7 Insulated Wood Framed Floors	81
Figure 5-8 Insulated Floor over Pier Foundation	82
Figure 5-9 Insulated, Sealed Crawlspace Walls	83
Figure 5-10 Floor Insulation Details	84
Figure 5-11 Let-in Bracing	86
Figure 5-12 Advanced Framing Insulation Details	87
Figure 5-13 Standard Framing versus Advanced Framing	88
Figure 5-14 Insulating Walls with Batts	89
Figure 5-15 Blown Sidewall Insulation Options	90
Figure 5-16 Spray Foam Insulation	91
Figure 5-17 Structural Insulated Panels (SIP)	92
Figure 5-18 Structural Insulated Panels Construction	93
Figure 5-19 Foam Sheathing Keeps Walls Warmer	95
Figure 5-20 Average Wall R-Value	97
Figure 5-21 Ridge and Soffit Vents	98
Figure 5-22 Pressure Problems Due to Powered Attic Ventilators	99
Figure 5-23 Attic Blocking Requirements	101
Figure 5-24 Full Width Batts	102
Figure 5-25 Insulating under Attic Floors	102
Figure 5-26 Insulation Options for Eaves	104
Figure 5-27 Airtight, IC-rated Recessed Lamps	105
Figure 5-28 Cathedral Ceiling Insulation Options	106
Figure 5-29 Cathedral Ceiling – Exterior Roof Insulation	107

6. *Windows and Doors*

Figure 6-1 Window Anatomy	110
Figure 6-2 Winter Heat Loss in a Typical Double-glazed Window	111
Figure 6-3 Summer Heat Gain in a Typical Double-glazed, Low-e Window	111
Figure 6-4 Relative Intensity of the Solar Spectrum	112
Figure 6-5 Metal Window with Thermal Break	115
Figure 6-6 Low-e, Gas-filled Windows	116
Figure 6-7 NFRC Label	117
Figure 6-8 Inside Window Temperatures in Cold Weather	118
Figure 6-9 Composition of Solar Heat Gain into Home	118
Figure 6-10 Guidelines for Overhangs	119

7. *Heating, Ventilation, and Air Conditioning*

Figure 7-1 Components of Forced-Air Systems	123
Figure 7-2 Automatic Zoned System with Dampened Bypass Duct	126
Figure 7-3 Air Conditioning with the Vapor Compression Cycle	127
Figure 7-4 Air Source Heat Pump	130
Figure 7-5 Sealed Mechanical Room Design for Non-direct Vent Furnace	132
Figure 7-6 Integrated Space and Water Heating System	134
Figure 7-7 Efficient Wood Heater Design	136
Figure 7-8 Direct Vent Heaters	137
Figure 7-9 Ventilation with Spot Fans	138
Figure 7-10 Whole House Ventilation System	139
Figure 7-11 Heat Recovery Ventilation (HRV) System	141

8. *Duct Design and Sealing*

Figure 8-1 Types of Ductwork	143
Figure 8-2 Efficiency Losses Due to Attic Return Leaks	145
Figure 8-3 Sealing Flex-duct Collar with Mastic	146
Figure 8-4 Disconnected Ducts are High Priorities	148
Figure 8-5 Duct Test on Return Grille	149
Figure 8-6 Duct Leaks in Inside Spaces	149
Figure 8-7 Seal All Leaks in Air Handling Unit	150
Figure 8-8 Shelf-Mounted Systems without Returns	150
Figure 8-9 Seal All Leaky Takeoffs	151
Figure 8-10 Sealing Leaky Boots	151
Figure 8-11 Comparison of Air Flow in Different 6-inch Ducts	152
Figure 8-12 Jump Duct	154
Figure 8-13 Transfer Grills – Over Doors	155
Figure 8-14 Transfer Grills – In Wall	156
Figure 8-15 Louvered Passage Doors	156

9. Water Heating, Appliances and Lighting

Figure 9-1 Typical Breakdown of Hot Water Use	160
Figure 9-2 Insulating Jackets for Electric and Gas Water Heaters	161
Figure 9-3 Heat Pump Water Heaters	162
Figure 9-4 Active Solar Water Heating Systems	163
Figure 9-5 Batch Solar Water Heating Systems	164
Figure 9-6 EnergyGuide Label	166
Figure 9-7 Efficacy of Different Lighting Types	169

10. Energy Efficient Roofing

Figure 10-1 Color Standard Cool Roof Color Materials	176
Figure 10-2 Laminated Shingles	178
Figure 10-3 Natural Slate Tiles	178
Figure 10-4 Concrete Tiles	179
Figure 10-5 Rubber Shingles	179
Figure 10-6 Landscaped “Green Roof”	185

Chapter 1

Site Planning

When anticipating the construction of a new home, selecting the site is one of the largest influences on the success of that endeavor. There is far more to good site planning than a choice of which lot seems best at first glance. There are the obvious decisions such as, matching the family's needs to the quality of the neighborhood, perhaps school districts, or commuting distance to work, shopping, and recreation.

The things that can go wrong, the complexity of the research and decisions to be made may seem intimidating, but the success of the whole project depends on it. Below are some questions and points to help think through the process of site planning.

Changing Times - Professional Advice

Many years ago, residences were normally designed by professionals who considered the above decisions a part of the process. Additionally, air conditioning brought with it the need to make buildings energy efficient. Now, when these and other systems are more important to energy efficiency, design professionals are usually commissioned only for the "jewel" projects. Every structure, from the modest to the award winning must go through the same question and answer process if it is to perform to its highest potential. Generally missing from the process today is the architect to assist and guide one through the design process from site evaluation, structures design, construction observation and the quality of work reporting.

In today's "do it yourself" (DIY) world, architects are often bypassed. At the very least, seek out an architect to consult on a limited hourly basis to get past the hurdles where expertise is lacking to decide, or to effectively monitor the builder's work. Below are some issues that should be investigated as the site selection and planning process progresses.

Surveys

The following surveys would be strongly advised for any new house:

- Property lines survey including metes and bounds (angle and distance dimensions) of all property lines. The legal description should be shown. It should indicate any easements or servitudes.
- An existing utility survey is important to locate and describe all connections to electricity, gas, water, sewer, storm drainage, telephone, cable junction/distribution box if any. This information can be combined with the property lines or topographic survey if the contract calls for that.
- A topographic survey is critical to design proper drainage and setting the optimum elevation of a slab, or wood framed first floor. The datum flood elevation measurement should be performed, certified by a registered land surveyor.
- Geotechnical investigation and analysis. This consists of taking one or more soil borings to 25' or more below grade. From several tests, the properties of the soil are determined, providing bearing pressure, shrink/swell potential and other data. The analysis is performed by a registered engineer and provides several recommended foundation types.

Location and Size

Although some of these questions may not affect energy efficiency of the house directly, they are among many fundamental questions that can affect whether or not to build on this site.

- Will the site be large enough to accommodate the size house desired, once the easements and zoning setbacks are deducted from the area of the land?
- Are school districts important?
- Will the property hold its value over time?
- Will this site be conducive to building an energy efficient structure?

Drainage

Is the topography flat, making it difficult to drain the site well or is it hilly or sloped creating the potential for erosion, interesting landscaping and perhaps difficult mowing?

Does the site have the potential for draining water away from the proposed house without diverting the runoff onto the neighbor's property?

Will separate improvements or permits be required to discharge storm runoff to a bayou, canal, etc?

Has a registered land surveyor to determine the minimum slab elevation above mean sea level that must be certified to meet the flood plane requirements been commissioned?

Will the above requirements necessitate bringing in a substantial volume of fill-grade earth?

Has the cost of fill and of compacting it under the structure, walks and drives been investigated?

Does the budget allow for this contingency?

Earthwork

“Dirt cheap” is an expression which has little meaning if remedial earthwork becomes necessary.

Most potential homeowners or builders do not realize the high value a relatively small investment in a geotechnical investigation and analysis by a professional engineer. Select fill, compacted properly under a slab on grade will go a long way for stability through the years. Some sites/houses may require drilled concrete shafts, a post tensioned slab, or other foundation type. The foundation appropriate for a house may not be the same as the one on either side of it.

The geotechnical report may indicate and describe a high bearing pressure soil with no indication of expansive soil which can shrink and swell under a structure as the moisture content varies. It can cause cracks and misalignment of the slab, footings or grade beam. This can wreak havoc with the remainder of the structure bearing on that foundation/slab. Remember that a geotechnical report is inexpensive if it produces a proper foundation/slab design under one's investment.

If the need arises to remove poor soils such as quick sand, organic deposits or expansive clay and replace them with select, compacted fill, the budget can be hit hard. Ignore the problem and the costs may be many times larger. It is possible to obtain an option to purchase the property and commission the geotechnical investigation. Losing one's option money and paying for the geotechnical reports may be far less expensive than making a blind property purchase only to discover much additional expensive earthwork and foundation enhancements are required. Even worse is not discovering those issues above before construction.

Geotechnical investigation is standard practice in commercial construction. Those structures are no different from residential structures in terms of placing pressure (pounds per square foot) on the soil

at the foundation. Either structure can settle differentially on soil with inadequate bearing capacity, or which contains decaying organic matter such as stumps or limbs of previously cleared timber. The primary difference in foundation failure rates is related to the awareness of the owner. What can not be seen beneath the surface on the site can ruin the investment made.

From an energy efficiency standpoint, sinking or heaving of the soil causes cracks in slabs, walls, miss-fitting doors and windows which can allow excessive infiltration into a house which may have been constructed as nearly air tight. The best insurance against this outcome is to procure the soil borings and analysis. Then, the bearing surfaces of all foundation members must be of adequate size to distribute their loads at less than the allowable soil bearing pressure.

Views and Access

Are there vistas from the site which should be appreciated and enjoyed from within the house? Conversely, are there unsightly views which should be screened? Will the site easily accommodate pedestrian and vehicular access? What about fire trucks? Where are nearby fire hydrants? How will these vistas and means of ingress affect where expanses of glass will be placed in the exterior wall of the structure? How will that be coordinated with the path of the sun throughout the day and with the changing altitude and bearing during the changing of the seasons? How will that affect the quantity of solar energy intake (heat gain)? For example, the north side of a building receives very little sunlight which can penetrate windows. Only in late June, very early or very late in the day does the sun come from the northeast or northwest. However, everyday, the early morning or late afternoon sun is very low in the east and west. It is not possible to block it with an overhang. Will vistas to the west become a problem with excessive solar heat gain or glare?

The proper placement of roof overhangs admits the low winter sun into the house, and excludes the higher summer sun. The design of the overhang is dependent on the height of the wall, the depth of the soffit, the vertical distance from the soffit to the head (top) and sill (bottom) of the window, or glass door (collectively called fenestration; meaning openings in an opaque wall). A uniform two foot overhang may, or may not be appropriate. See Chapter 6 for how to determine the best overhang for the location.

Understanding Solar Position

Figure 1-1 below is a Solar Chart used to determine the position of the sun at any time in the year. The curved horizontal arcs represent the 21st day of each month. Solar altitude is shown by concentric circles in 10 degree increments. Curved lines indicating the time of day are labeled as 6 a.m. to 6 p.m. Azimuth lines (similar to bearing) are radial lines in 10 degree increments from South. Interpolation is permissible.

Figure 1-1
Solar Path Chart

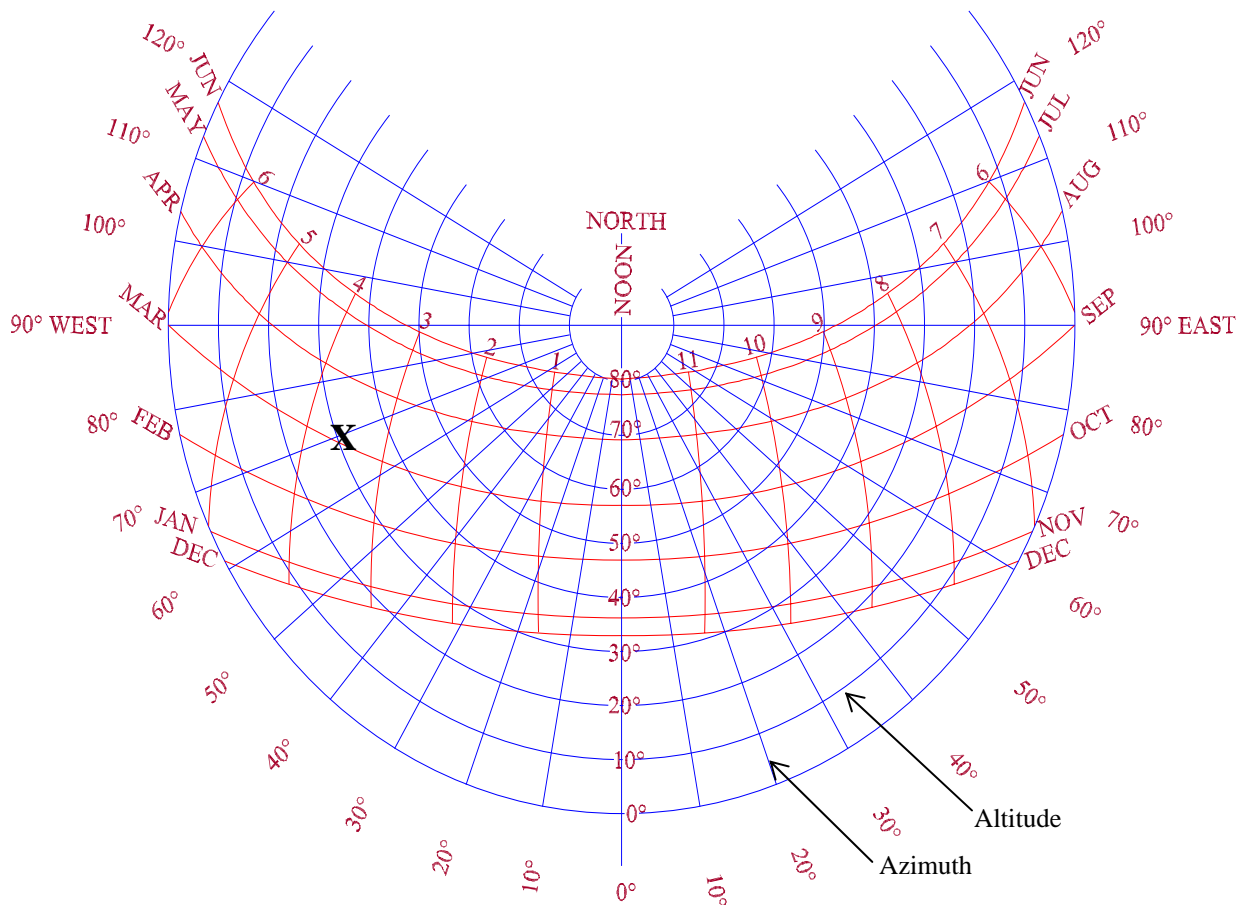

In the example indicated by the “X”:

- Month/Day: *March 23 (or August 30)*
- Time: *3:35 p.m.*; Azimuth: *70° west of South*
- Altitude: *30.5° above the horizon.*

The chart in Figure 1-1 above is for 32 degrees North Latitude (North of Alexandria). A chart can be calculated mathematically for a specific latitude, but this one is representative of most of Louisiana. It is based on “sun time” for the particular location. Using the chart as an overlay on a site plan provides an understanding of how the sun’s path each day of year will affect window locations, admitting daylight and heat gain when and where desired and excluding them when they would be detrimental. This information can also be expressed in a table as shown in Chapter 6, Figure 6-10.

Natural Cooling

Louisiana’s hot, humid summers drive most people indoors to seek air conditioned comfort — comfort that is paid for by high monthly cooling bills. Natural cooling design measures can further reduce the air conditioning needs of any house. Natural cooling guidelines are especially important for passive solar homes because their large expanses of south-facing glass can cause overheating if

unprotected in summer. In Louisiana, summer discomfort is caused by humidity as much as by heat. Natural cooling techniques and new approaches designed to reduce humidity levels can promote comfort on moderately warm days. Natural cooling techniques and proper insulation and air sealing will continue to save money and energy. Remember that shading from trees can greatly reduce the ambient temperature, saving air conditioning. Capturing the natural breezes on the site can reduce the need for air conditioning during spring and fall.

Prevailing Breezes - Wind Rose

A consideration is wind direction and speed. This interesting Wind Rose diagram (see Fig. 1-2 below) is available from: http://mesonet.agron.iastate.edu/sites/locate.php?network=LA_ASOS

It is very useful in determining the predominant strength and direction of wind for the area of the site. This allows design for natural ventilation and shielding from cold winter winds. The web site will construct a wind rose for the most populated areas of the state. Thirty-eight stations on land are available in Louisiana plus Vicksburg and Natchez in Mississippi. Be sure to try several years as these plots are for one year of data and will vary somewhat, year to year. By using January 1 to March 1 and July 1 to September 1, the most significant prevailing winds can be seen for the more extreme seasons. April to June and October to December will show the temperate seasons when many people like to be out-of-doors. Be careful to avoid hurricanes as they will distort the average results.

Figure 1-2
Wind Roses Winter and Summer

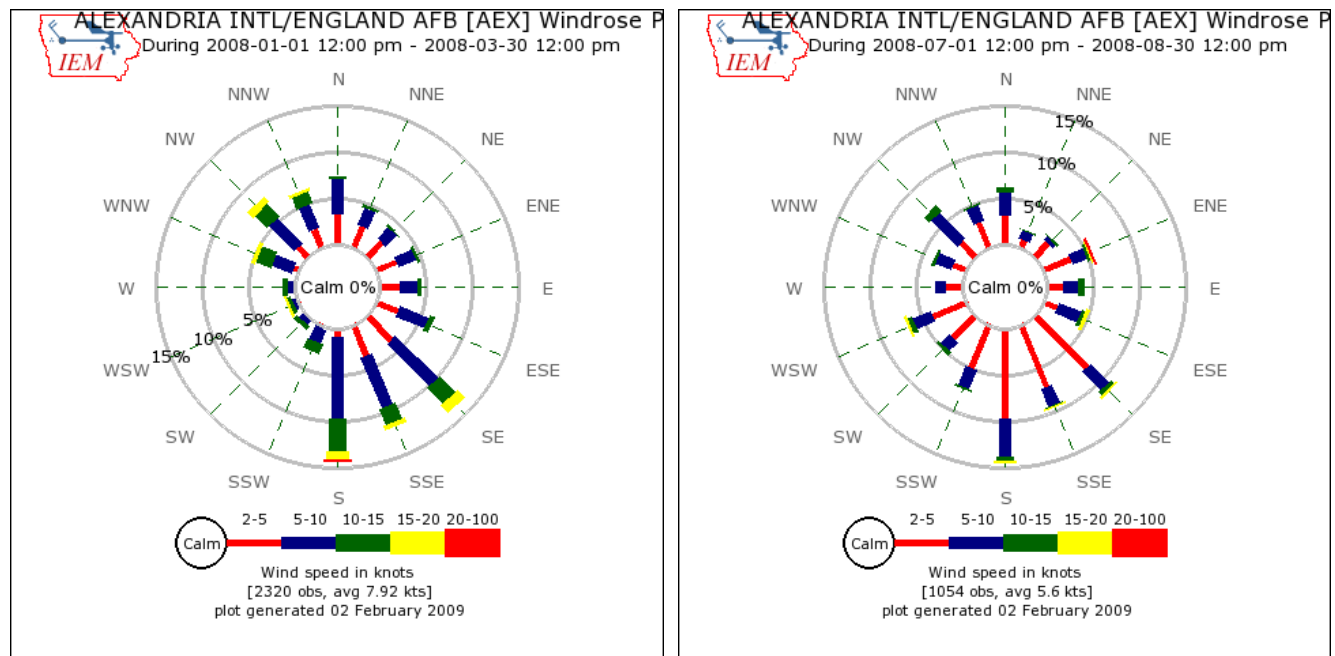

1 knot = 1.1508 miles per hour, 5 knots = 5.75 mph, 15 knots = 17.26 mph, etc.

The length of the ray indicates the fraction of the time that the wind blew from a particular direction while the different sized/colored sections indicate the proportion of that time within a particular speed range. The center shows the percentage of the time period that was calm and the average wind speed for the period is shown below the speed legend.

The USDA also has a Wind Rose program that illustrates the yearly average since 1961 of wind direction and speed for four cities around the state:

<ftp://ftp.wcc.nrcs.usda.gov/downloads/climate/windrose/louisiana/>

Natural Ventilation

Even in the land of hot and humid, there are those times when we would prefer natural ventilation to heating or cooling. The fresh air is great for removing odors or pollutants from our environs. The saving for not using the heating and cooling is another plus. Use the Wind Rose information combined with site specific information. A forest or high hill on one side of the site will change wind directions. Large man made structures will also, but are not usually found in residential areas. Locating on the side of a hill or on the edge of a lake or other large cleared area will affect wind patterns. For example if the site is on a man made lake, it is probably sloping; that is, a hill on the side away from the lake. How will the same winds affect similar sites on north and south shores of the lake? The north shore site will have some of the winter winds blocked and receive direct breezes in the summer, while the south shore site will be just the opposite. The degree of affect will depend on the magnitude of the obstacles being considered.

It may be desired to present the bedroom side of the house with few windows to predominantly north winter winds. The west side may be “shaded” by a garage and storage area. But the south or south east breezes of the spring and fall present a good time to welcome the breezes by opening various windows on opposite sides of the house. Careful planning is required to combine the many beneficial features into an efficient house.

Figure 1-3
Natural Ventilation Design Strategies

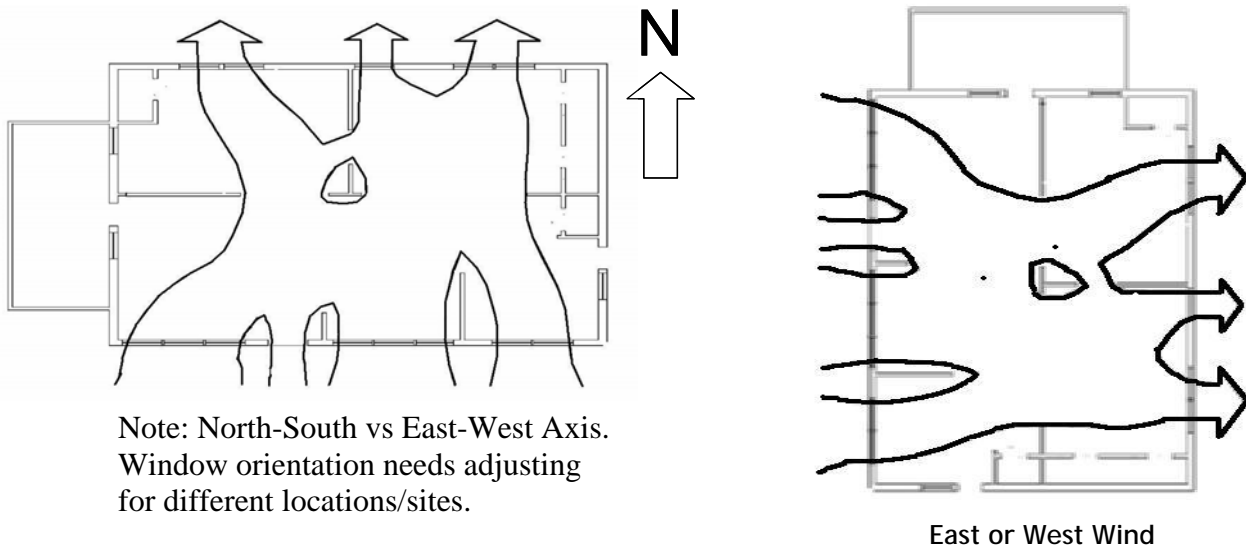

**Figure 1-4
Stack Effect**

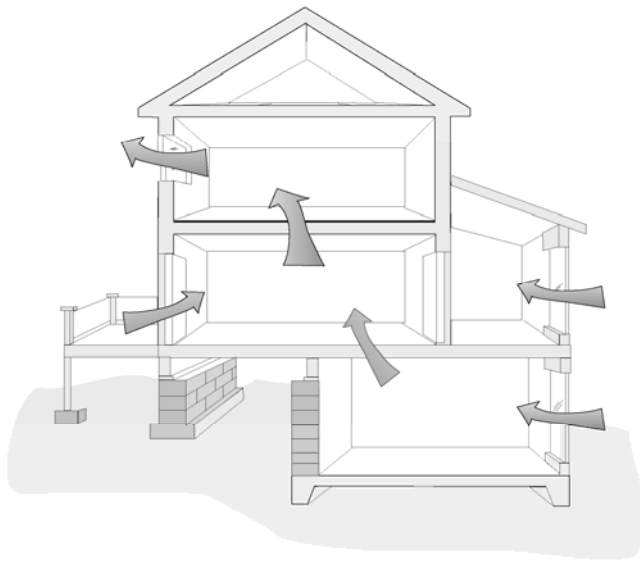

As the interior air heats up it rises to the higher parts of the structure and escapes creating suction. The suction pulls in cooler (lower) air from outside. The structure behaves like a chimney cooling and aerating the house. The taller the structure, the stronger the force. This effect is why most old plantation homes have such high ceilings and double hung windows.

Orientation of Building and Components

1. Major glazed areas are oriented within 20 degrees of north and south which have overhangs for summer shading.
2. Placing the garage on the west blocks summer sun.

**Figure 1-5
Overhang Types**

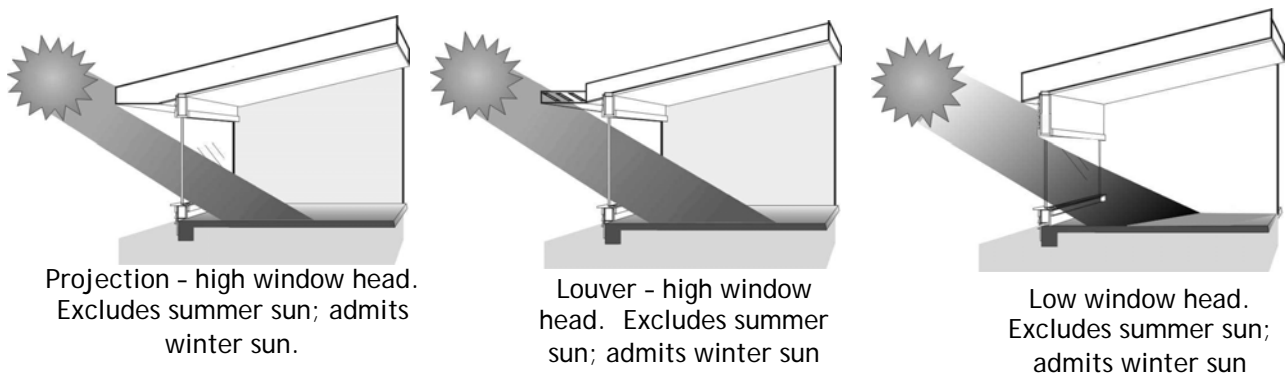

For more specific information concerning overhangs and window shading options see Chapter 6.

**Figure 1-6
Site Planning**

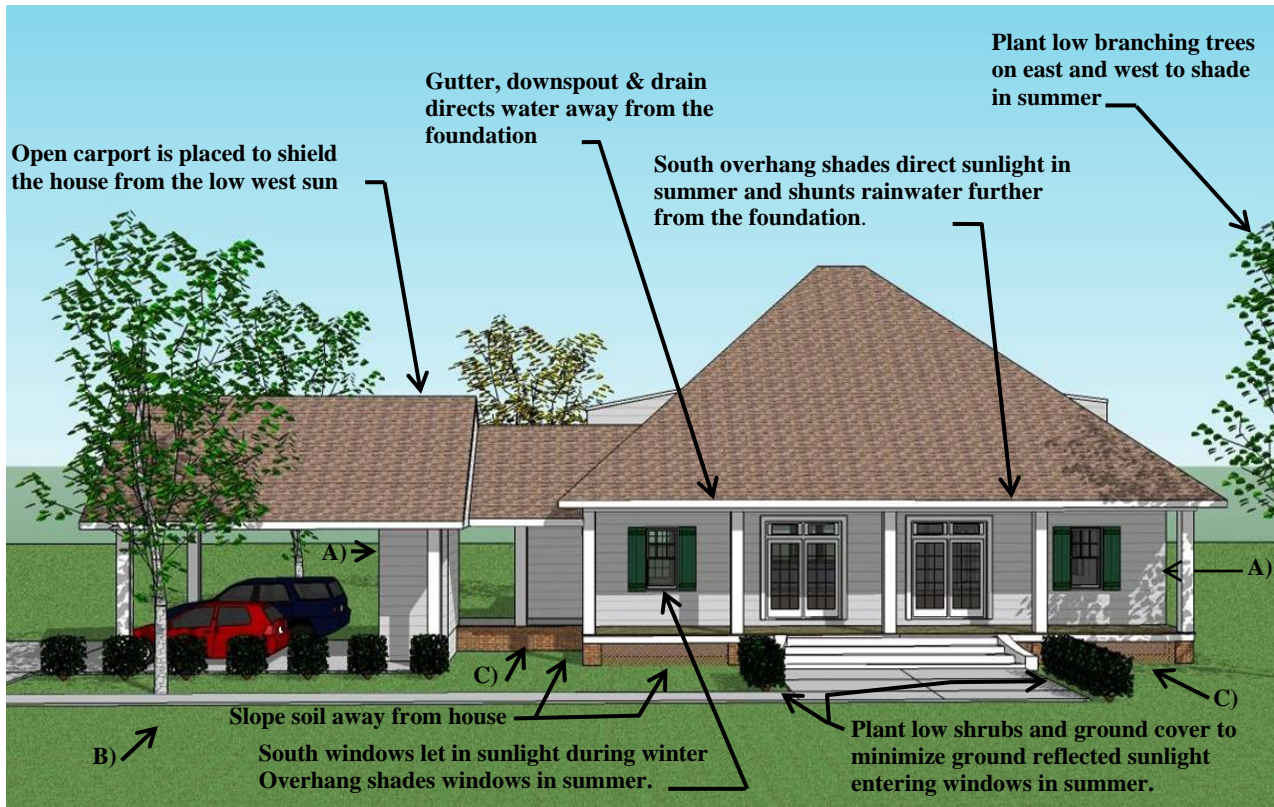

LEGEND FOR FIGURE 1-6 ABOVE

- A) Minimize east and west windows; use north windows for daylighting and ventilation.
- B) Water-saving landscaping practices known as xeriscaping: substitute mulched shrubbery and ground cover for turf grass. Where used, choose turf grasses that require less water, use drip rather than spray irrigation on plants; shade lawn to reduce evaporation.
- C) Continuous perforated foundation drain connected to subsurface closed drain carrying moisture away from foundation. Embed perforated drain in gravel and cover with durable filter fabric, to prevent silt intrusion into gravel bed and reduction of intake holes in perforated pipe drain.
- D) Termite prevention measures: remove construction lumber and other wood from soil before backfilling; obtain termite treatment and long-term renewable contract from reliable, established company; consider use of "termite traps," both to eliminate pests and to determine if they are present; if using slab insulation, make sure pests control company will guarantee home against infestation. For slabs on grade, always have the termiticide applied.

Figure 1-7 shows a typical site plan for a new residential project. It is advisable to elongate house on the east-west axis (even more than in this illustration) to maximize north & south glazing and minimize east & west glazing. Ensure that finished grading does not leave low areas (ponding) and that the site generally slopes away from the structure to drain. Puddles are not just a nuisance, but can be a fertile breeding place for disease bearing mosquitoes.

**Figure 1-7
Site Planning**

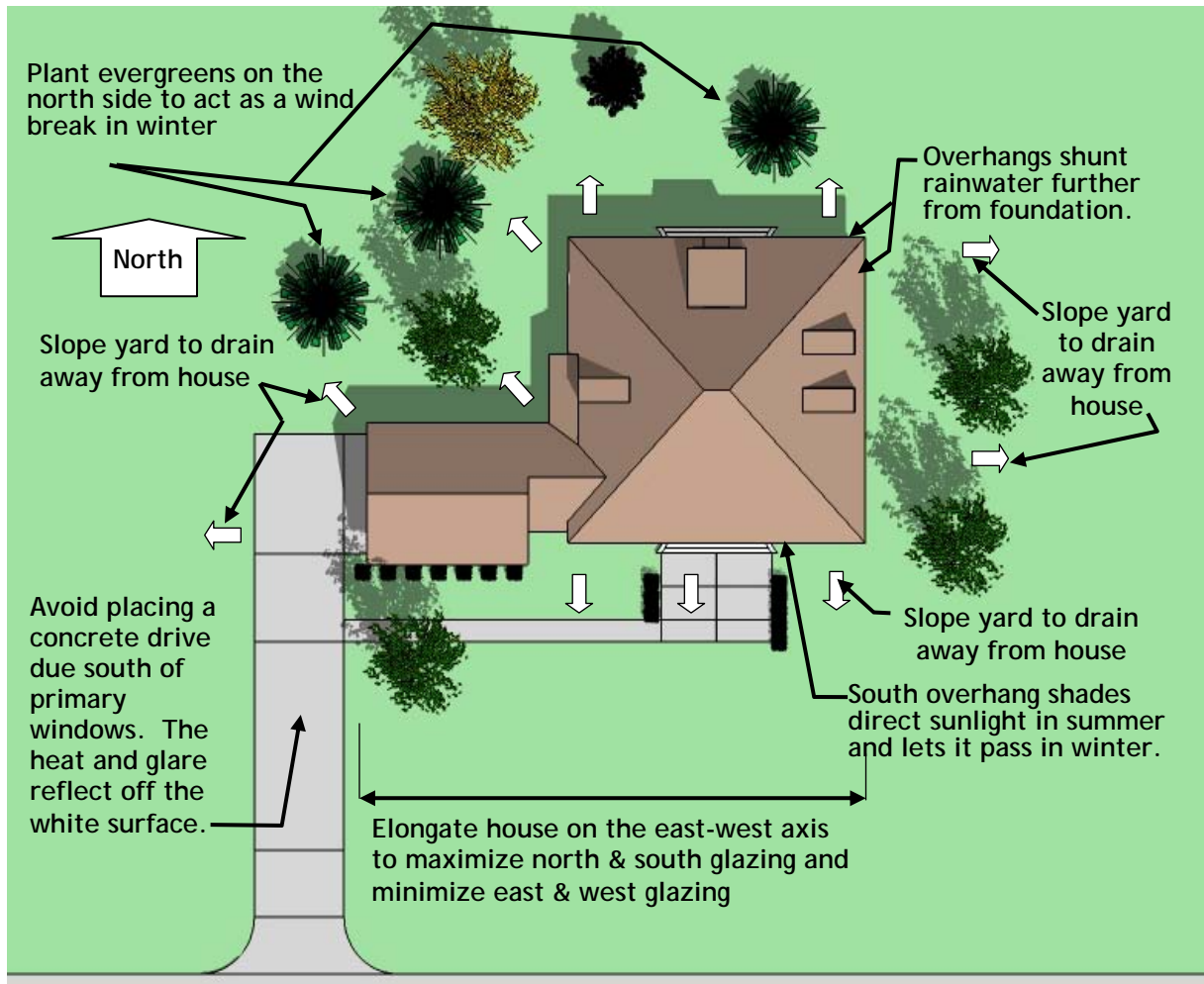

Plant low-limb, deciduous trees to the east and west of the living spaces. This helps to permit the passage of some sun into the space in winter, but the heavy summer foliage blocks the sunlight when the heat gain is least wanted inside the space. South facing overhangs can be designed to permit the passage of low altitude winter sunlight into the space, while excluding the high altitude summer sun. Low shrubbery can help prevent ground bounce glare from reflecting off the ground or paved areas and penetrating the south windows.

Landscaping and Trees

According to the U.S. Department of Energy report, "Landscaping for Energy Efficiency", careful landscaping can save up to 25% of a household's energy consumption for heating and cooling. Trees and vines on trellis or arbor are very effective means of shading in the summer months. In addition to contributing shade, landscape features combined with a lawn or other ground cover can reduce air temperatures as much as 9°F in the surrounding area when water evaporates from vegetation and

cools the surrounding air. Louisiana’s abundant trees are wonderful for natural shading and cooling. However, they must be located so as to provide shade in summer and permit sun light in the winter coming from the south. Even deciduous trees that lose their leaves during cold weather block some winter sunlight – bare trees can block over 50 percent of the available solar energy if they have a lot of limbs.

Landscaping Guidelines

1. Ground cover reduces reflected sunlight.
2. Deciduous trees shade east, west, southeast, and southwest sides in summer.
3. Trellis with deciduous vine can shade east and west walls.
4. Windbreak of evergreen trees and shrubs to the north buffers winter winds.

**Table 1-1
Shading Design Strategies**

Window Direction	Landscaping	Overhangs	Shade Screens	Interior Shades Can eliminate over 40% of solar gains.	Recommended Strategies
South	Deciduous trees shade some in winter. Provide a few high branching trees. Use shrubs and ground cover to reduce sunlight reflected into windows from the ground.	Provide good control if sized correctly. They do not shade diffuse sunlight on hazy days and ground-reflected sunlight.	Block up to 70% of sunlight before it gets through window. Can be very effective.	Should be used on all windows without exterior shade screens. Roller blinds are more effective than Venetian blinds.	Shrubs & ground cover. Overhang that does not block winter sunlight. Use shade screens or interior shades.
Southeast & Southwest	High branching trees are appropriate near southeast and southwest corners of house.	Less effective than on south windows.	Effective.	Effective.	High branching trees, shrubs and ground cover. Use shade screens or interior shades.
West	High branching trees are appropriate. Low branching trees block low afternoon sun. Shrubs next to the house are less effective, but block diffuse, ground-reflected sunlight.	Must be as long as the window is tall (e.g. porches and carports). Not effective for low sun angles.	Effective.	Effective.	High branching trees, shrubs and ground cover. Use shade screens or interior shades.
East, Northeast & Northwest	Low branching trees block low morning and afternoon sun. Shrubs next to the house are less effective, but block ground-reflected sunlight.	Must be as long as the window is tall (e.g. porches and carports) or use awnings that extend over windows.	Effective.	Effective.	Low branching trees and ground cover. Use shade screens or interior shades.
North	Evergreen Trees provide diffuse summer shading and serve as a wind break.	Ineffective.	Effective if incoming light is a problem.	Can control the small amount of incoming sunlight.	Evergreen trees and interior shades.

Conclusion

Proper consideration of each of the unique criteria found with each site and planning a resolution to conflicts is key to successful and more productive site planning. The design decisions will change the site for a long time. The following questions should be asked before making a final decision:

- Is weather data on hand for predominant wind direction and strength?
- Are there obstructions that will alter wind patterns?
- How much rain falls annually by month?
- How does the land drain on its surface?
- Where to drain water without infringing on the neighbor's right not to have it on his property?
- Is there a crest which would make an ideal high building platform?
- Does the earth have sufficient strength of bearing pressure for what is to be built?
- Does it drain well internally?
- Is it sandy or does it contain expansive clay with its volumetric changes?
- Are there rock outcrops or other unusual features?
- Where will the automobile traffic be?
- How will groceries get into the kitchen in the rain?
- Where are the best views from the site? The worst?
- Where will the path of the sun be in July; in January?
- How will windows and doors be affected by:
 - Area?
 - Orientation?
 - Shading?
 - Solar Heat Gain Coefficient (SHGC) and U factor?
- Will the yard be oriented well for future photovoltaic panels or solar water heaters?

Armed with knowledge about these characteristics of the site, various plans can be tested by the questions above. A final site plan from these scenarios can provide lower utility bills and a more pleasant environment for many years. The remainder of construction decisions will be easier to address when the plan addresses all the questions and others that are aesthetic. The energy efficiency of the home will be greater if the precepts of good site planning are followed.

Notes:

Chapter 2

The House as a System

We sometimes think of our homes as independent structures, placed on an attractive lot, and lived in without regard to the world around. Yet, most homes have problems - some minor nuisances, others life-threatening:

- Mold on walls, ceilings, and furnishings
- Mysterious odors
- Excessive heating and cooling bills
- High humidity
- Rooms that are never comfortable
- Decayed structural wood and other materials
- Termite or other pest infestations
- Fireplaces that do not draft properly
- High levels of formaldehyde, radon, or carbon monoxide

These problems occur because of the failure of the home to properly react to the outdoor or indoor environment. The house should be designed to function well amid fluctuating temperatures, moisture levels, and air pressures. Quality builders are concerned about these problems, but are not always certain what steps to take to prevent them. They must start by considering what makes buildings healthy and comfortable.

The following factors define the quality of the living environment. If kept at desirable levels, the house will provide comfort and healthy air quality.

- Moisture levels - often measured as the relative humidity (RH). High humidity causes discomfort and can promote growth of mold and organisms such as dust mites
- Temperature - both dry bulb (that measured by a regular thermometer) and wet bulb, which indicates the amount of moisture in the air. The dry bulb and wet bulb temperatures can be used to find the relative humidity of the air.
- Air quality - the level of pollutants in the air, such as formaldehyde, radon, carbon monoxide, and other detrimental chemicals, as well as organisms such as mold and dust mites. The key determinant of air quality problems is the strength of the source of pollution.
- Air movement - the velocity at which air flows in specific areas of the home. Higher velocities make occupants more comfortable in summer, but less comfortable in winter.
- Structural integrity - the ability of the materials that make up the home to create a long-term barrier between the exterior and inside.

Concepts

Heat Flows in Homes

Heat transfer - heat loss and heat gain - between a home and its exterior envelope has a major impact on health and comfort. Figures 2-1, 2-2, and 2-3 explain the three primary modes of heat transfer.

When building energy efficient homes, many builders focus on reducing conduction heat gain and loss by installing more insulation. However, air leakage and duct leakage are serious contributors to heating and cooling bills. They can also create moisture and indoor air quality problems.

Unfortunately, many homes labeled as energy efficient are not sealed for air leaks or duct leaks. In summer, cooling needs are driven by the location and shading of windows. Also, the percentage of the cooling load that is for latent cooling (humidity removal) can increase substantially in homes with well insulated thermal envelopes.

Several general areas contribute significantly to energy bills. The largest is air leaks through the envelope. We expect the walls, floors and ceiling to keep the elements outdoors. There are many penetrations in these that allow air to move into and out of the house. With that air, heat and moisture can enter the house, contributing as much as 30-40% of the energy bill alone. The next greatest loss comes from poorly sealed duct work, which can contribute 10-20% of the typical energy bill. Windows are not as good at resisting energy flow as insulated walls. They let the sun shine in winter and summer. However, in winter, heat radiates out through them as well. Typical single pane windows allow heat to flow in or out 10 times more easily than a good wall and can contribute 10% to the energy bill. Walls and ceilings can easily contribute 15% to the bill. Not all of these losses can be prevented, but they can be managed and optimized.

There are also internal heat and moisture sources from the inhabitants, lighting, cooking, bathing, etc. that are a part of living. These are influenced by lifestyle and the house has limited effect on them. Depending on the family, these items can be from 30-50% of the energy bill. Controlling them efficiently can make a house more comfortable without a great expense.

Conduction

- The transfer of heat through solid objects, such as the ceiling, walls, and floor of the home.
- Insulation and quality windows reduce conduction losses.

Figure 2-1
Home Losing Heat through Conduction in Winter

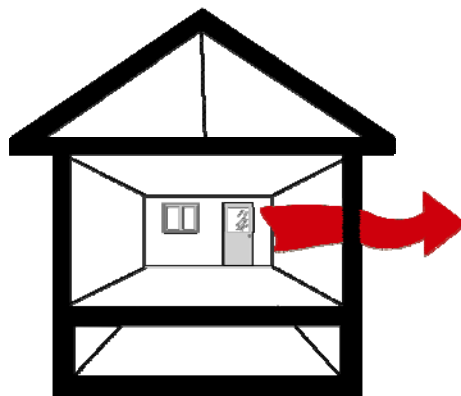

Convection

- The flow of heat by currents of air.
- As air becomes heated, it expands until it transfers the heat to an adjacent object which cools it; at which point it contracts and sinks. Inside of a space this forms a cycle of air movement until the walls of the space reach equilibrium with the air temperature.
- The flow of air into a home is known as infiltration; the outward flow is called exfiltration. In this publication, infiltration and exfiltration are known together as air leakage.

Figure 2-2
Convection in the Home

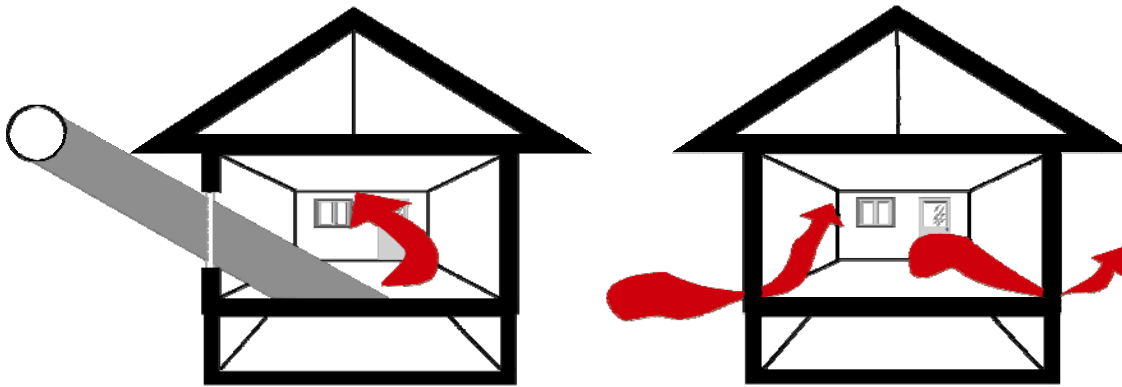

Radiation

- The movement of energy from warm to cooler objects across empty spaces.
- Examples include radiant heat traveling from inner panes of glass to outer panes in double glazed windows in winter, roof deck to attic insulation during hot, sunny days.
- Can be reduced by installing reflective barriers; examples include radiant heat barriers in attics and low-emissivity coatings for windows.

Figure 2-3
Radiation Entering House

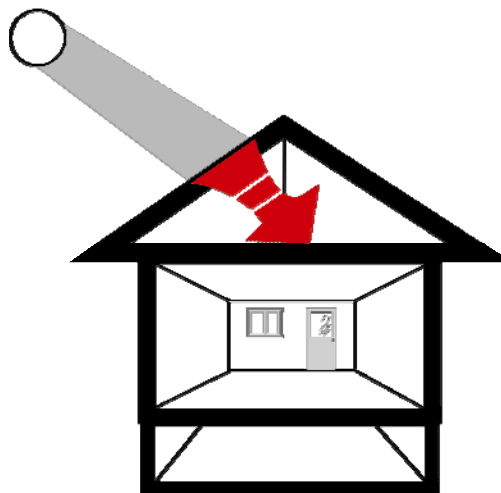

Air Leaks and Indoor Air Quality

Both building professionals and homeowners have concerns about indoor air quality. It is important to understand that few studies on the subject have shown a strong relationship between indoor air quality and the air tightness of a home. In order for a home or any other occupied space to be livable, a certain amount of fresh air exchange must occur continually since the normal process of breathing exchanges oxygen with carbon dioxide which will accumulate unless it is replaced with fresh air. The amount necessary for any inhabited space has been determined to be 0.35 fresh air changes per hour. Building a leaky home may help lessen the intensity of the problem, but will neither eliminate it, nor necessarily create a healthy living situation. Air leaks often bring in air quality problems from outside, such as:

- Mold spores from crawlspaces and outdoors
- Radon, while rare in Louisiana, entering from crawlspaces and under-slab areas
- Water vapor from crawlspaces and outdoor air
- Pollen and other allergens from outdoor air
- Dust and other particles from crawlspaces and attics

The best solution to air quality problems is to build a home as tightly as possible and install an effective ventilation system that can bring in fresh, filtered outside air (not crawlspace or attic air) under the control of the homeowner.

Figure 2-4
Air Quality Problems from “Fresh” Air

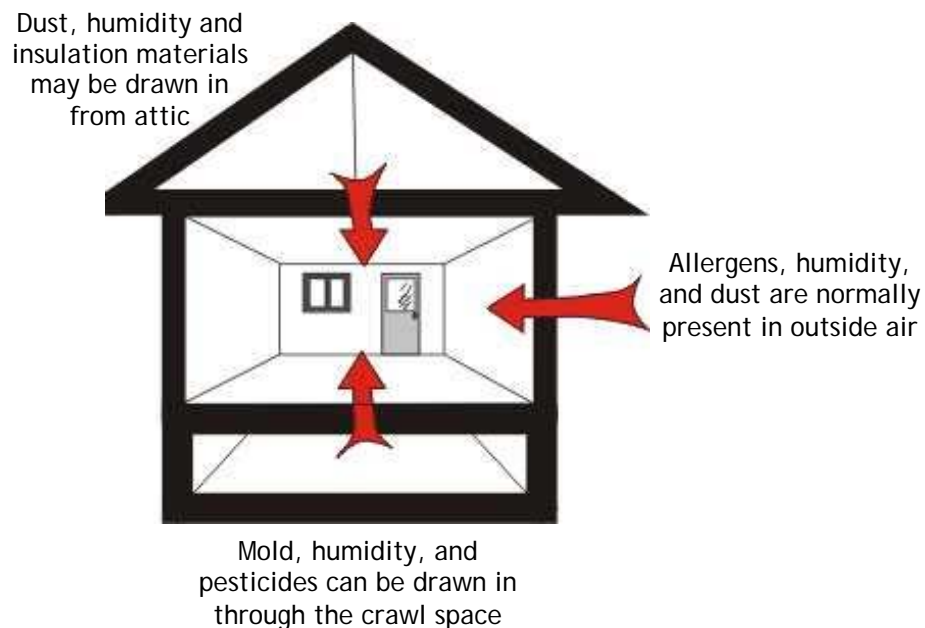

Creating Boundaries

In the field of building science, the term boundary has been applied to an external barrier created to control moisture, air leakage, and thermal conduction losses and gains. Every successful energy efficient home should have a moisture boundary, air leakage (pressure) boundary, and thermal boundary that separate unconditioned areas of the home from areas with heating or cooling.

**Figure 2-5
Thermal Boundaries**

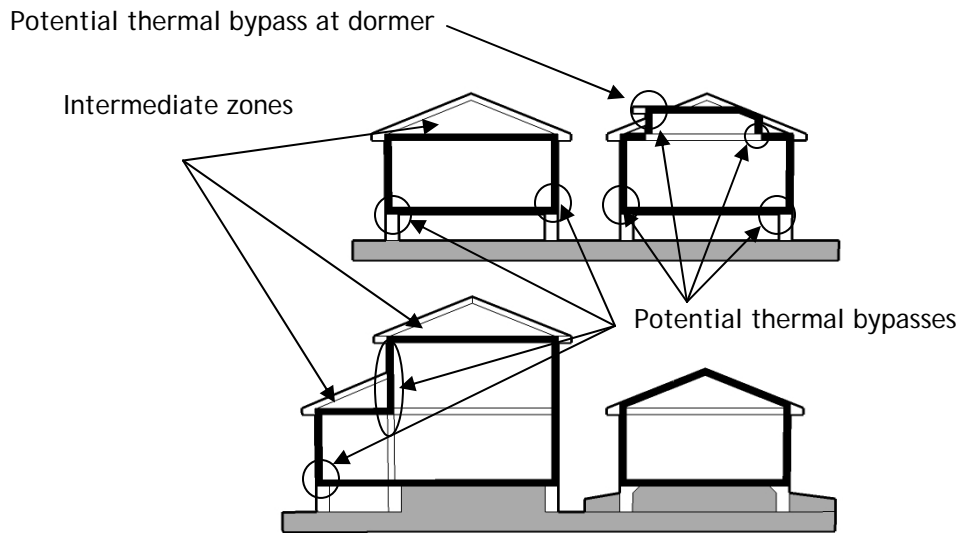

The designer and builder must direct the subcontractors about how to install continuous air and ductwork sealing materials, insulation, moisture retarders, drainage systems, and other building materials. The air quality and durability of a home depend vitally on how well these boundaries are installed and maintained.

**Figure 2-6
Conditions for Condensation**

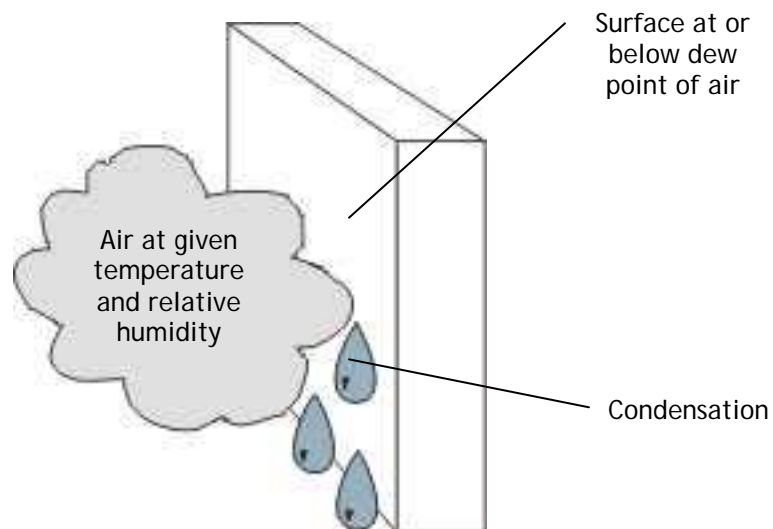

How Condensation Occurs

Air is made up of gases such as oxygen, nitrogen, and water vapor. The amount of water vapor that air can hold is determined by its temperature. Warm air can hold more vapor than cold air. The amount of water vapor in the air is measured by its relative humidity (RH). At 100% RH, water vapor condenses into a liquid. The temperature at which water vapor condenses is its dew point.

$$\text{RH} = \frac{\text{The amount of water vapor in the air at a given temperature}}{\text{The maximum amount of water vapor that air can hold at that temperature}}$$

A convenient tool for examining how air, temperature, and moisture interact is the Psychrometric Chart. Preventing condensation involves reducing the RH of the air, increasing the temperatures of surfaces exposed to moist air, and blocking the flow of moisture using air barriers and vapor barriers. Builders should always give spaces the ability to shed or reject moisture.

Moisture and Relative Humidity

A psychrometric chart aids in understanding the dynamics of moisture control. A simplified chart shown in Figure 2-7 relates temperature and moisture. Note that, at a single temperature, as the amount of moisture increases (moves up the vertical axis) the relative humidity of the air also increases. At the top curve of the chart, the relative humidity reaches 100% - air can hold no additional water vapor at that temperature, called the dew point, so condensation will occur.

Winter Condensation in Walls

In a well built wall, the temperature of the inside surface of the sheathing will depend on the insulating value of the sheathing and the indoor and outdoor temperatures.

Example: When it is 35°F outside and 70°F at 40% relative humidity inside:

- The interior surface of plywood sheathing will be around 39°F.
- The interior surface of insulated sheathing would be 47°F.

The psychrometric chart can help predict whether condensation will occur:

1. In Figure 2-8, find the point representing the indoor air conditions.
2. Draw a horizontal line to the 100% RH line.
3. Next, draw a vertical line down from where the horizontal line intersects the 100% RH line.

In the example, condensation would occur if the temperature of the inside surface of the sheathing were at 44°F. Thus, under the temperature conditions in this example, water droplets may form on the plywood sheathing, but not on the insulated sheathing.

Figure 2-7
Psychrometric Chart

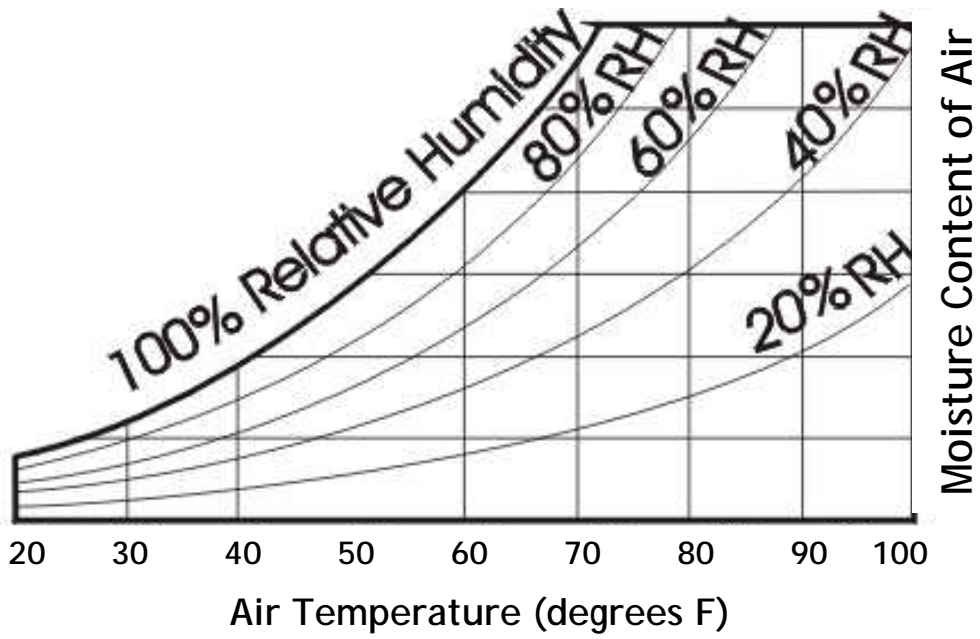

Figure 2-8
Winter Dew Point Temperature Inside Walls

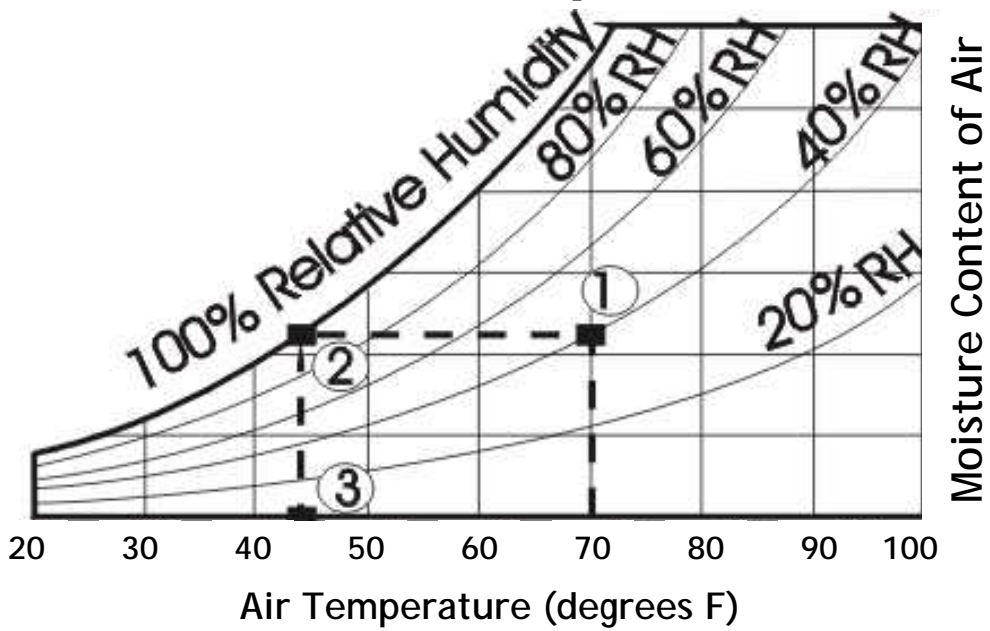

Figure 2-9
Summer Condensation in Walls

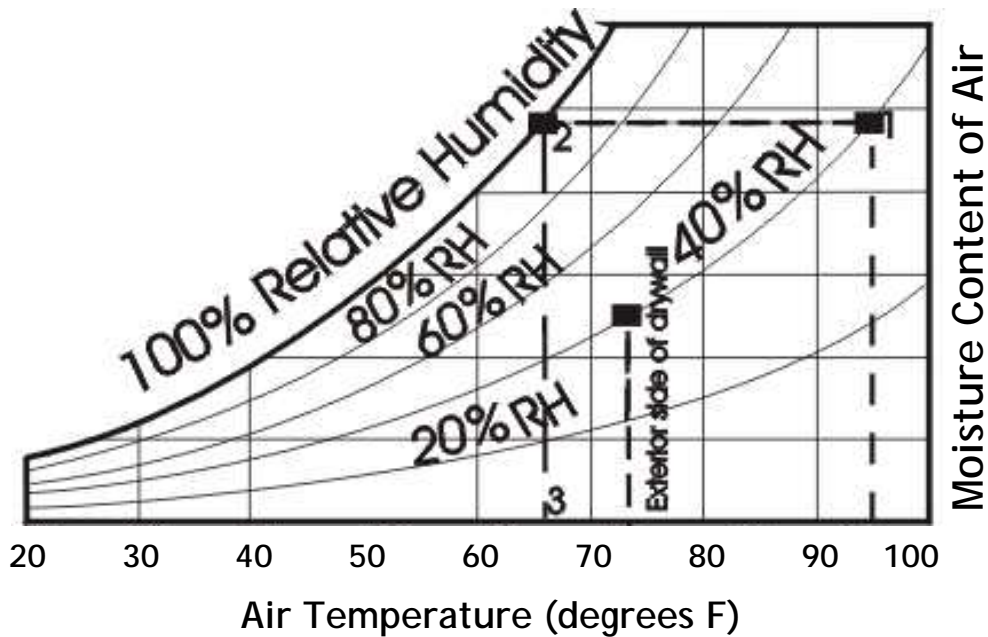

Figure 2-9 depicts a similar case in summer. If the interior air is 75°F, and outside air at 95°F and 40% relative humidity enters the wall cavity, will condensation occur on the exterior side of the drywall, which would be about 73°F? Using the psychrometric chart, we find that the dew point of the outside air leaking into the wall cavity would be about 67°F. Since the drywall temperature is greater than the dew point, condensation should not form.

Effect of Relative Humidity

Humans respond dramatically to changes in relative humidity (RH):

- At lower RH, we feel cooler as moisture evaporates more readily from our skin.
- At higher levels, we may feel uncomfortable, especially at temperatures over 78 degrees.
- Dry air can often aggravate respiratory problems.
- Mold and fungi grow in air over 70% RH.
- Dust mites prosper at over 50% RH.
- Wood decays when the RH is near or at 100%.
- Humans are most comfortable at 40% to 60% RH.

Figure 2-10 shows that relative humidity levels in the 40% to 60% range accomplish two major goals: provide human comfort and minimize the many diverse negative impacts that occur in drier and more humid air. By controlling air leakage and properly designing HVAC systems, relative humidity levels should remain at desirable levels.

Figure 2-10
Relative Humidity Ranges

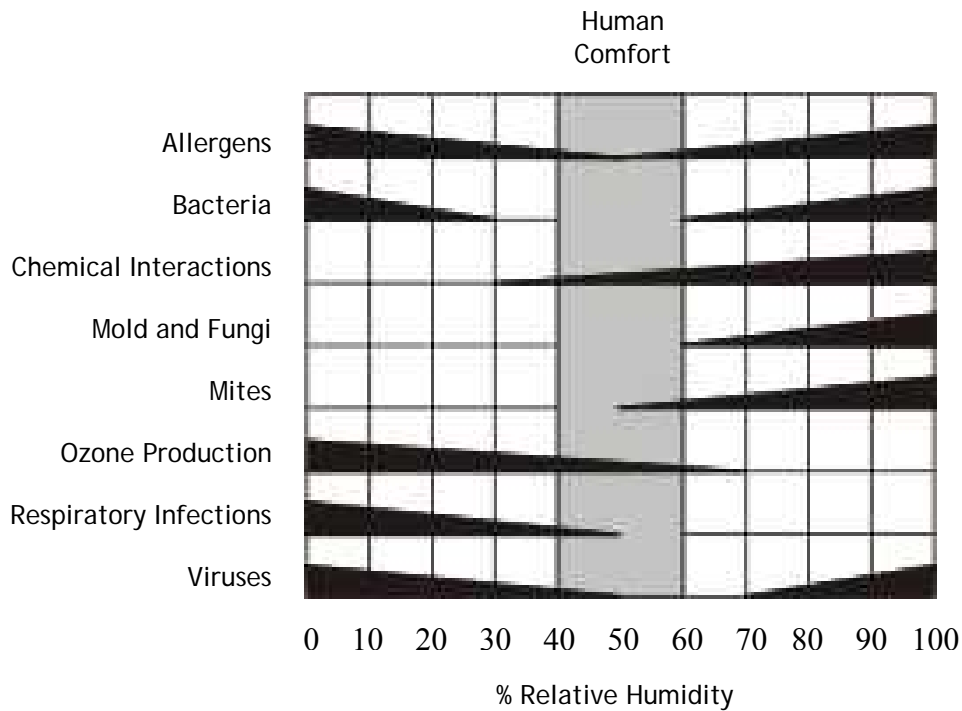

Systems in a Home

Whether the health and comfort factors of temperature, humidity, and air quality remain at comfortable and healthy levels depend on how well the home works as a system. Every home has systems that are intended to provide indoor health and comfort:

- Structural system
- Moisture control system
- Air barrier system
- Thermal insulation system
- Comfort control system

Structural System

The purpose of this book is not to show how to design and build the structural components of a home, but rather to describe how to maintain the integrity of these components. Key problems that can affect the structural integrity of a home include erosion, roof leaks, water absorption into building systems, excessive relative humidity levels, fire, and summer heat buildup.

Structural recommendations

To prevent these structural problems, the home designer and builder should:

- Ensure that the footing is installed level and below the frost line. Use adequate reinforcing and make sure concrete has the proper slump and strength.
- Divert ground water away from the building through a properly designed and installed foundation drainage system and effective gutters, downspouts, and rain water drains.
- Build a quality roof and thorough exterior flashing to prevent rainwater intrusion. Install a "drainage plane" that sheds water outside (Figure 2-12).
- Seal penetrations that allow moisture to enter the building envelope via air leakage. Use fire-stopping sealants to close penetrations that are potential sources of "draft" during a fire.
- Install baffles in attics to prevent air from washing over insulation.
- Install a series of capillary breaks that keep moisture from migrating through foundation systems into wall and attic framing.

Air Barrier System

Air leakage can be detrimental to the long term energy efficiency and durability of homes. It can also cause many other problems, including:

- High humidity in summer and dry air in winter
- Allergy problems
- Radon entry (though not a significant issue in Louisiana) via leaks in the floor system
- Mold growth
- Drafts
- Excessive heating and cooling bills
- Increased damage in case of fire

An air barrier system may sound formidable, but it is actually a simple concept - seal all leaks between conditioned and unconditioned spaces with durable materials. Achieving success can be difficult without diligent efforts, particularly in homes with multiple stories and changing roof lines. Air barriers may also help a home meet local fire codes. One aspect of controlling fires is preventing oxygen from entering a burning area. Most fire codes have requirements to seal air leakage sites. There are a number of air barrier systems - all can be effective with proper installation. They are one of the key features of an energy efficient home. The basic approach is:

- Seal all air leakage sites between conditioned and unconditioned spaces:
 - Caulk or otherwise seal penetrations for plumbing, electrical wiring, and other utilities.
 - Seal junctions between building components, such as bottom plates and band joists between conditioned floors.
 - Consider using insulation that also air seals, such as foam or densely packed cellulose or rock wool.
- Seal bypasses - hidden chases, plenums, or other air spaces through which attic or crawlspace air leaks into the home.
- Install a continuous air barrier system such as the Airtight Drywall Approach or exterior house-wrap that is vapor permeable and sealed properly.

For more detailed information on sealing air leaks, see Chapter 4.

Moisture Control System

Homes should be designed and built to provide comfortable and healthy levels of relative humidity. They should also prevent both liquid water and water vapor from migrating through building components. An effective moisture control system includes quality construction to shed water from the home and its foundation, vapor and air barrier systems that hinder the flow of water vapor, and heating and cooling systems designed to provide comfort all year.

There are four primary modes of moisture migration into our homes. Each of these must be controlled to preserve comfort, health, and building durability.

Bulk moisture transport

- The flow of moisture through holes, cracks, or gaps
- Primary source is rain and groundwater
- Causes include:
 - Poor flashing
 - Inadequate drainage
 - Poor quality weather-stripping or caulking around joints in building exterior (such as windows, doors, and bottom plates)
- To solve, install a building drainage plane:
 - No roof leaks; gutters connected to drain system carry roof water away from foundation
 - Walls built with continuous drainage plane (see Figure 2-12)
 - High quality weather stripping or caulking around joints in building exterior (such as windows, doors, and bottom plates)
 - All openings through wall - for windows, doors, plumbing, lighting, etc. - well flashed and sealed to prevent rain penetration
 - Soil sloped away from home to divert ground water from foundation
 - Foundation wall waterproofed and provided with a drainage system - gravel or a gravity drain membrane
 - Foundation drain, preferably located beside the footing, to carry water away from the house

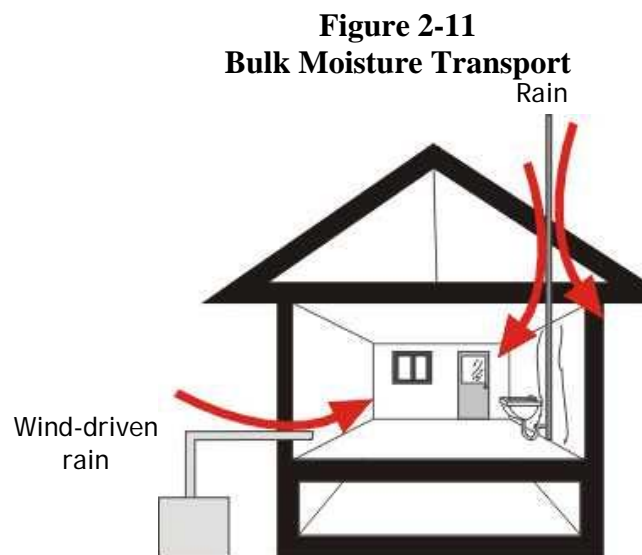
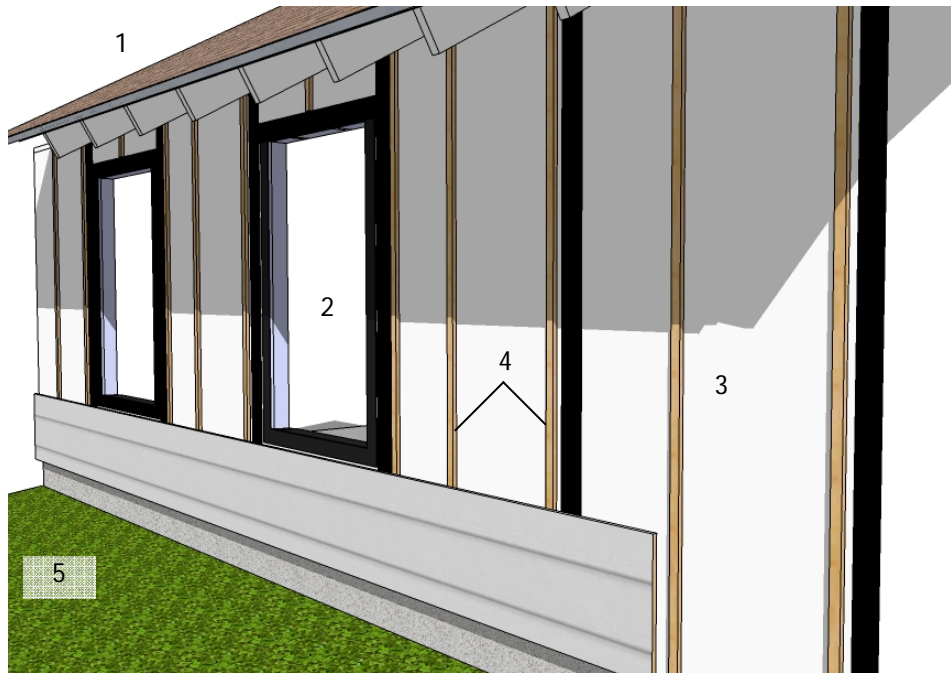

Figure 2-12
Drainage Plane



1. Design and build a durable roof with maximum overhang allowable by the International Residential Code, to shade windows.
2. Carefully flash around windows, doors, and other penetrations and seal to drainage plane.
3. Tape or seal joints in foam sheathing or house wrap to prevent water and air penetration.
4. Install furring strips between wall sheathing and siding to create a drainage plane, a ventilating air space that allows water to drain.
5. Provide a finished grade that slopes away from the foundation and a French drain beneath to keep seepage from undermining them.

Capillary action

- Wicking of water through porous materials or through small cracks.
- Primary sources are from rain or ground water.
- Causes include:
 - Water seeping between overlapping pieces of exterior siding
 - Water drawn upward through pores or cracks in concrete slabs
 - Water migrating from crawlspaces into attics through foundation walls and wall framing
- Solved by completely sealing pores or gaps, increasing the size of the drainage planes (usually to a minimum of 1/8 inch), or installing a waterproof, vapor barrier material to form a capillary break.

The foundation system should include a drain pipe surrounded by a gravel bed covered by a filter fabric to prevent dirt from stopping up the drain. In addition, install a layer of 10-mil polyethylene under concrete slabs and footings. Use sill sealer between concrete foundation walls and sill plates. Lapped wood siding should be primed on the back. In addition, the wall system should have an air space behind the siding and a continuous drainage plane behind the air space, such as 30-pound roofing felt installed shingle style.

Figure 2-13
Capillary Action

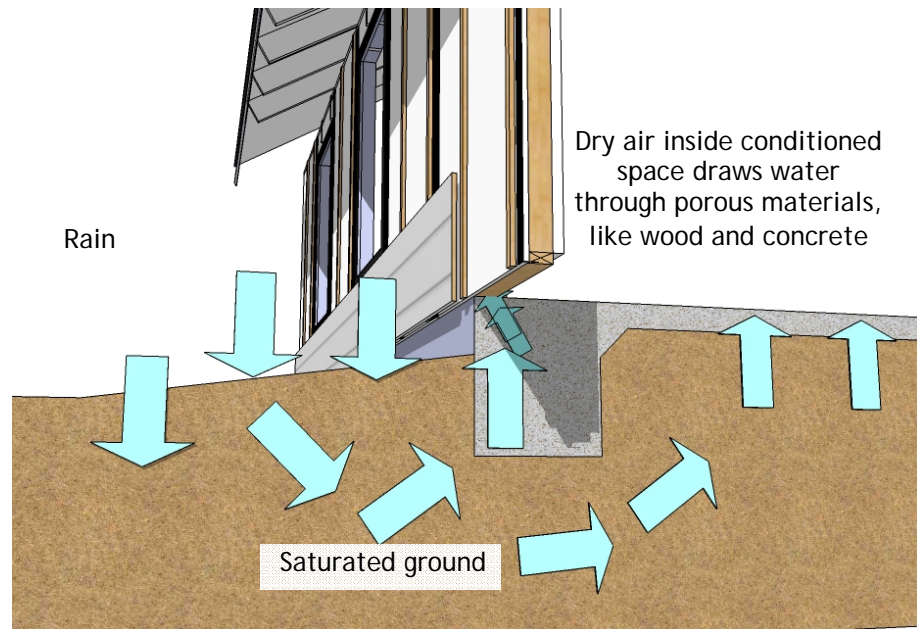

Air transport

- Unsealed penetrations and joints between conditioned and unconditioned areas allow air containing water vapor to flow into enclosed areas. Air transport can bring 50 to 100 times more moisture into wall cavities than vapor diffusion.
- Primary source is water vapor in air.
- Causes include air leaking through holes, cracks, and other leaks between:
 - Interior air and enclosed wall cavities
 - Interior air and attics
 - Exterior air and interior air, adding humidity to interior air in summer
 - Crawlspace and interior air
- Solved by creating an Air Barrier System.

Vapor Barriers or Vapor Diffusion Retarders

A vapor barrier or vapor diffusion retarder (VDR) is a material that reduces the rate at which water vapor can move through a material. The older term "vapor barrier" is still used even though it may inaccurately imply that the material stops all of the moisture transfer. Since everything allows some water vapor to diffuse through it to some degree, the term "vapor diffusion retarder" is more accurate.

The ability of a material to retard the diffusion of water vapor is measured by units known as "perms" or permeability. A perm is equal to one grain of water vapor at 73.4°F (23°C) passing through a square foot of material per hour at a differential vapor pressure equal to one inch of mercury (1 grain/square-foot*hour*inch-of-mercury). Any material with a perm rating of less than 1.0 is considered a vapor retarder.

Vapor Diffusion

- Water vapor in air moves through permeable materials.
- Primary source is water vapor in the air.
- Causes:
 - Interior moisture permeating wall and ceiling finish materials
 - Exterior moisture moving into the home in summer
 - Moist crawlspace air migrating into the home
- Solution: proper installation of a vapor retarder.

Vapor barriers are not recommended in Louisiana

Winters are mild so interior vapor barriers are not necessary; exterior sheathing materials usually serve as partial vapor barriers in summer. Wall systems without vapor barriers can dry to the inside of the home in summer and to the outside in winter. An exterior “drainage plane” is required as shown in Figure 2-12 above.

Figure 2-14
Typical Water Vapor Transport
(100 square foot wall)

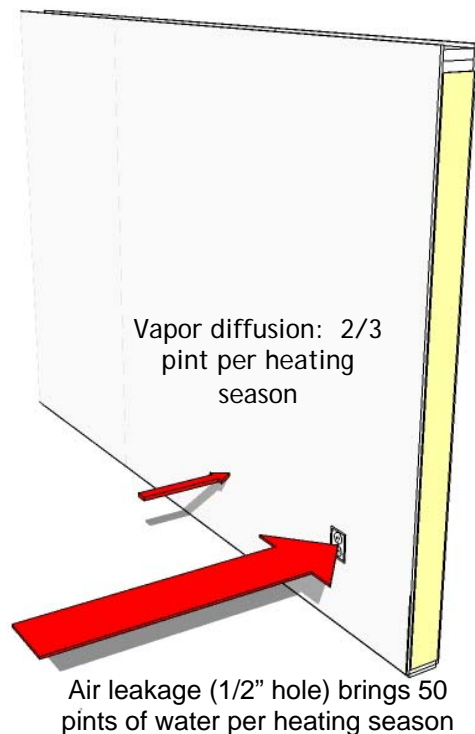

Moisture Problem Example

The owner of a residence complains that her ceilings are dotted with mildew. On closer examination, an energy auditor finds that the spots are primarily around recessed lamps located close to the exterior walls of the building. What type of moisture problem may be causing the mildew growth, which requires a relative humidity over 70%? In reality, any of the forms of moisture transport could cause the problem:

- Bulk moisture transport - the home may have roof leaks above the recessed lamps.
- Capillary action - the home may have a severe moisture problem in its crawlspace or under a slab. Via capillary action, moisture travels up the slab, into the framing lumber, and all the way into the attic. If the attic air becomes sufficiently moist, it may condense on the surface of the cool roof deck and drip onto the insulation and drywall below.
- Air transport - unsealed recessed lamps are quite leaky; if relatively warm and moist air is leaking into the attic, and the roof deck is cool, the water vapor in the air may condense and drip back down onto the sheetrock. The moisture moves through the gypsum and mold can grow. This is the most likely explanation.
- Vapor diffusion - the home's ceiling may not have an adequate vapor barrier in the vicinity of the recessed lamps, resulting in excessive vapor flow into the attic. Although this situation is highly unlikely in Louisiana, the true cause may be a combination of the above problems.

Figure 2-15
Drying to the Interior

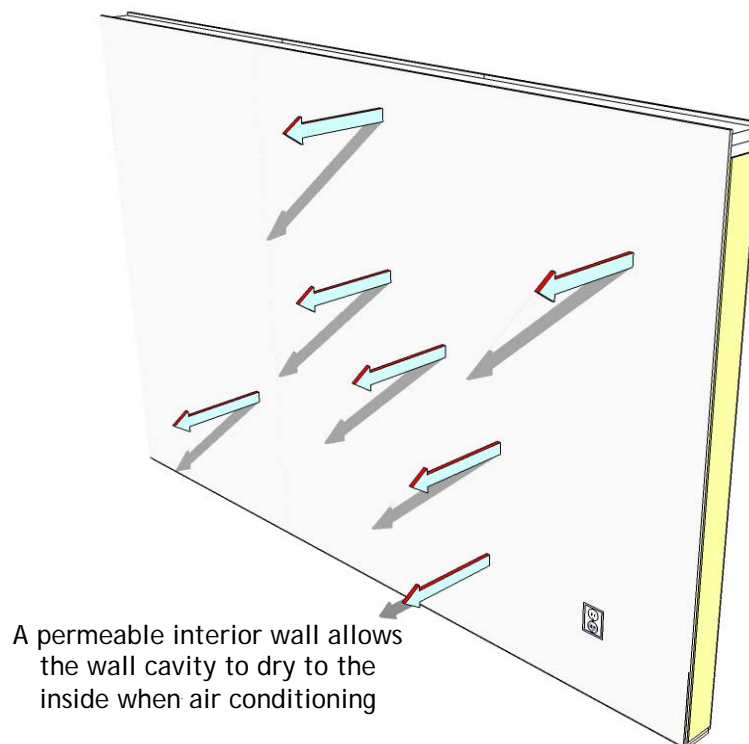

**Table 2-1
Building Materials and Their Perm Ratings**

Material	Perm Rating*	Vapor Retarder?
½" Gypsum Wallboard	38.0 – 42.0†	No
Latex Primer	7.0 – 10.0†	No
7/16" Oriented Strand Board	0.77 – 3.48††	Sometimes
1" Thick Extruded Polystyrene	0.40 – 1.60††	Sometimes
Kraft Paper Facing	1.0†	Yes
2-mil Polyethylene Film	0.06 – 0.22††	Yes
Alkyd-based or vapor retarder paint	< 0.05††	Yes
1-mil Aluminum Foil Laminate	< 0.05††	Yes
Plywood with exterior glue	0.70	Yes
DuPont™ Tyvek® DrainWrap™	50	No
*grains/[hr-ft ² -in.Hg], 7000 grains = 1 pint of water †Tested at Johns Manville Technical Center ††Solplan Review, November 1999 http://www.jm.com/engineered_products/wallcoverings/moisture.pdf		

Thermal Insulation System

Thermal insulation and energy efficient windows are intended to reduce heat loss and gain due to conduction. As with other aspects of energy efficient construction, the key to a successfully insulated home is quality installation. Substandard insulation not only inflates energy bills, but may create comfort and moisture problems. Key considerations for effective insulation include:

- Install R-values equal to or exceeding the International Residential Code of 2006 or the latest update version implemented and presently in effect.
- Do not compress insulation.
- Provide full insulation coverage of the specified R-value; gaps dramatically lower the overall R-value and can create areas subject to condensation.
- Prevent air leakage through insulation - in some insulation materials, R-values decline markedly when subject to cold or hot air leakage.
- Air seal knee walls and other attic wall areas and insulate with a minimum of R-19 insulation.
- Support insulation so that it remains in place, especially in areas where breezes can enter or rodents may reside.
- Consider installing a radiant heat barrier; especially in homes whose roofs receive sunlight in the summer and have less than R-30 insulation.

Comfort Control System

The heating, ventilation, and air conditioning (HVAC) system is designed to provide comfort and improved air quality throughout the year, particularly in winter and summer. Energy efficient homes, especially passive solar designs, can reduce the number of hours during the year when the HVAC systems are needed. These systems are sometimes not well designed or installed to perform as intended. As a consequence, homeowners often suffer higher heating and cooling bills and more areas with discomfort than necessary. Poor HVAC design can also lead to moisture and air quality problems.

One major issue concerning HVAC systems is their ability to create pressure imbalances in the home. Duct leaks can create serious problems. Even closing a few doors can create situations that may endanger human health. Pressure imbalances increase air leakage, which may draw additional moisture into the home. Proper duct design and installation helps prevent pressure imbalances from occurring. HVAC systems must be designed and installed properly, and maintained regularly by qualified professionals to provide continued efficient and healthy operation. See Chapters 7 and 8 for a detailed discussion of this subject area.

Duct Leaks and Infiltration

Forced-air heating and cooling systems should be balanced - the amount of air delivered through the supply ducts should be equal to that drawn through the return ducts. If the two volumes of air are unequal, pressure imbalances may occur in the home, resulting in increased air leakage and possible health and safety problems. For more information on duct sealing, see Chapter 8.

Carbon Monoxide

Consider a home that has been built to airtight specifications - an air barrier system success. However, the home's ductwork was not well sealed - a HVAC system failure. It has more supply leakage than return leakage which creates a strong negative pressure inside the home when the heating and cooling system operates. The home has only a single return in the main living room. With overnight guests in the home, many of the interior doors are kept closed.

When the system operates, the rooms with closed doors become pressurized, while the central living area with the return becomes significantly depressurized. Because the house is very airtight, it is easier for these pressure imbalances to occur. The home has a fireplace without an outside source of combustion air. When the fire in the unit begins to dwindle, the following sequence of events could spell disaster for the household:

- The fire begins to smolder, producing increased carbon monoxide and other harmful pollutants.
- Because the fire's heat dissipates, the draft pressure, which draws gases up the flue, decreases.
- The reduced output of the fire causes the thermostat to turn on the heating system. Due to duct pressures and closed interior doors, the blower creates a relatively high negative pressure in the living room.
- Because of the reduced draft pressure in the fireplace, the negative pressure in the living room causes the chimney to backdraft - the flue gases are drawn back into the home.
- Backdrafting may generate considerable carbon monoxide and cause severe, if not fatal, health consequences for the occupants. This example is extreme, but similar events occur in dozens of Louisiana homes each year. The solution to the problem is to eliminate the causes of pressure imbalances and install an external source of combustion air for the fireplace, a set of tightly fitting doors and a carbon monoxide detector.

Systems are Interdependent

It must be remembered that a house is a complex system of smaller systems. Each of these smaller systems can not only affect the performance of the house in general, but they can also affect the other systems within the house. Understanding these systems will help the homeowner and builder make educated decisions about which systems to use. The following chapters provide more detailed information on these individual systems and their effects.

Notes:

Chapter 3

Energy Efficient Features

Investments in energy efficient features in new homes are remarkable because everyone wins:

- Most homeowners win because they receive a positive cash flow within 1-3 years.
- Homeowners benefit from improved comfort, better indoor air quality and reduced moisture problems.
- Heating, ventilation and air conditioning contractors have fewer callbacks.
- Realtors receive additional fees from the additional cost of the energy features and enhance their reputations by selling higher quality homes that homebuyers appreciate.
- Participating financial institutions can receive higher mortgage payments because the homes have lower annual ownership costs due to reduced utility bills.
- National lending agencies such as the Federal Housing Authority (FHA) and the Veteran's Administration (VA) permit energy efficient home buyers to qualify for larger loans because their energy bills will be lower.
- The local community benefits as more money stays within the community; and local subcontractors and product suppliers make additional income by selling improved energy efficient features.

To compensate for heat gains in hot humid climates like Louisiana air conditioning design must take into consideration all forms of energy that will elevate the temperature in the home. These forms are often called “energy loads.” “Energy loads” are imposed either by climate, life style choices, people and animals, and power required to light the spaces and cook food. Each watt of electricity used in the home, whether it is running a computer, playing music, operating a blow dryer or charging a cell phone battery, produces 3.412 Btus. The average human being at rest may put out 500 Btus. Pets may produce even more heat. Then there is power from lighting, cooking, washing, and making hot water. Add to that the amount of light passing through windows facing the sun at different times of the day. This applies to walls and ceilings as well even though they are more resistant to heat conduction. All have quantifiable load characteristics that must be taken into account when designing the air conditioning system. In winter the envelope components reverse their flow while the others contribute to heating the space.

Achieving Energy Efficiency

Overall success, resulting in a well-designed and constructed home that is also energy efficient, requires careful and cooperative collaboration between the owner, the architect (or licensed home designer), and the builder. The architect, if used, or a home energy rater should serve as the main coordinating party between the participants.

Designing and building a home that uses energy wisely does not mean sacrificing a home's aesthetic qualities or amenities. Quite the opposite; usually, the better the home is designed, the easier and more natural it is to make it energy efficient, comfortable and convenient. While an energy efficient home usually incorporates higher quality windows and doors than a standard code compliant home, the payback due to increased energy savings for the better quality materials is usually 2-3 years.

After payback, the owner continues to benefit from the energy savings as long as he occupies the home.

International Residential Code 2006 (IRC 2006)

The state of Louisiana adopted IRC 2006, effective January 2007, as its residential building code. Chapter 11 of the IRC 2006 deals with residential energy efficiency. Figure 3-1 is the climate zone map that is used by the IRC 2006. Along with Tables N1102.1 and N1102.1.2 of the IRC 2006, a builder can determine which residential building components are permitted at that location. The dotted white line separates the portion of the southeast that is considered to have high humidity affecting building design.

For the purpose of this guide we are only concerned with Louisiana, Zones 2 & 3, Hot and Humid, including the north east corner of the state for the following energy related items:

1. The building thermal envelope*
2. Insulation and fenestration**
3. Duct insulation for supply and return ducts
4. Duct sealing
5. Air leakage and moisture control
6. General lighting - limiting air leakage

* The building envelope consists of the building's roof, walls, windows and doors. The envelope controls the flow of energy between the interior and exterior of the building. Source: U.S. DOE EERE website (URL: <http://www.eere.energy.gov>, May 2, 2007).

** Fenestration is defined as the arrangement, proportioning and design of windows and doors in a building.

Figure 3-1
International Residential Code (2006) Climate Zone Map

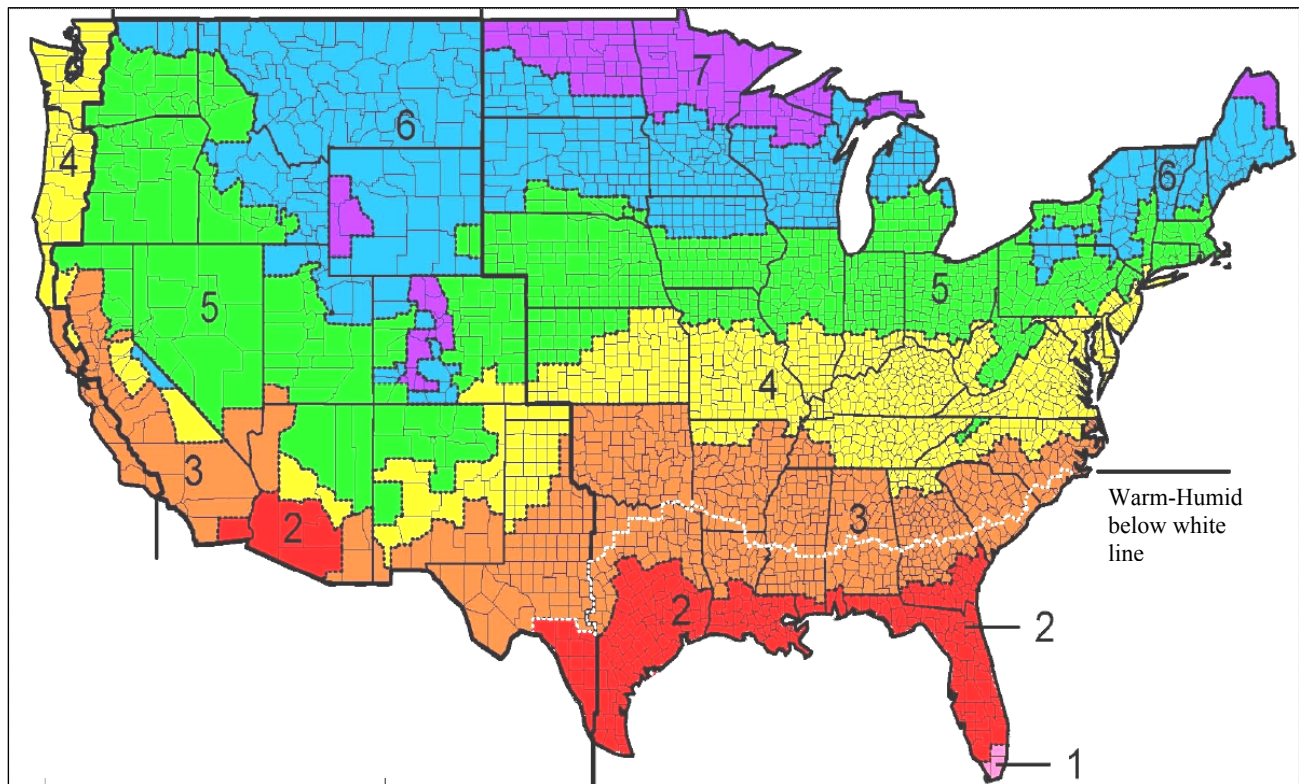

Quality of Construction Affects Energy Efficiency

Quality of the basic construction goes a long way in providing comfort to the homeowner and savings on energy costs. The following areas should be thoroughly reviewed in the design process and during construction:

1. One of the most important aspects of the planning of a home is making advantageous use of the site for the comfort of the occupants. Planning for a nice view from the site is very important. However, where windows are placed affects energy use. Solar heat gain is greatest from the East and West, so minimizing glass on those sides is the best idea. With good windows, cold North winds are not much of a winter heating concern in Louisiana, therefore orienting the home to face north and installing more glazing there is better than facing either east or west. Southerly views are also better as long as the windows are shaded with the maximum code-allowed overhang. Another good solution for providing shade to South facing windows is the use of an arbor or pergola, to reduce the amount of light hitting the glass without obstructing the view. See Chapter 1 for more detail on site planning.
2. Quality of framing and installation of insulation and windows. In order to have infiltration control of a house all the pieces must be fit together tightly. Any cracks must be sealed by a material that will last and conform to any changes that occur. Discontinuous or compacted insulation does not perform as it would if installed properly. Some critical areas are shown in Figures 3-2, 3-3, and 3-4.

**Figure 3-2
Envelope Construction Ideas**

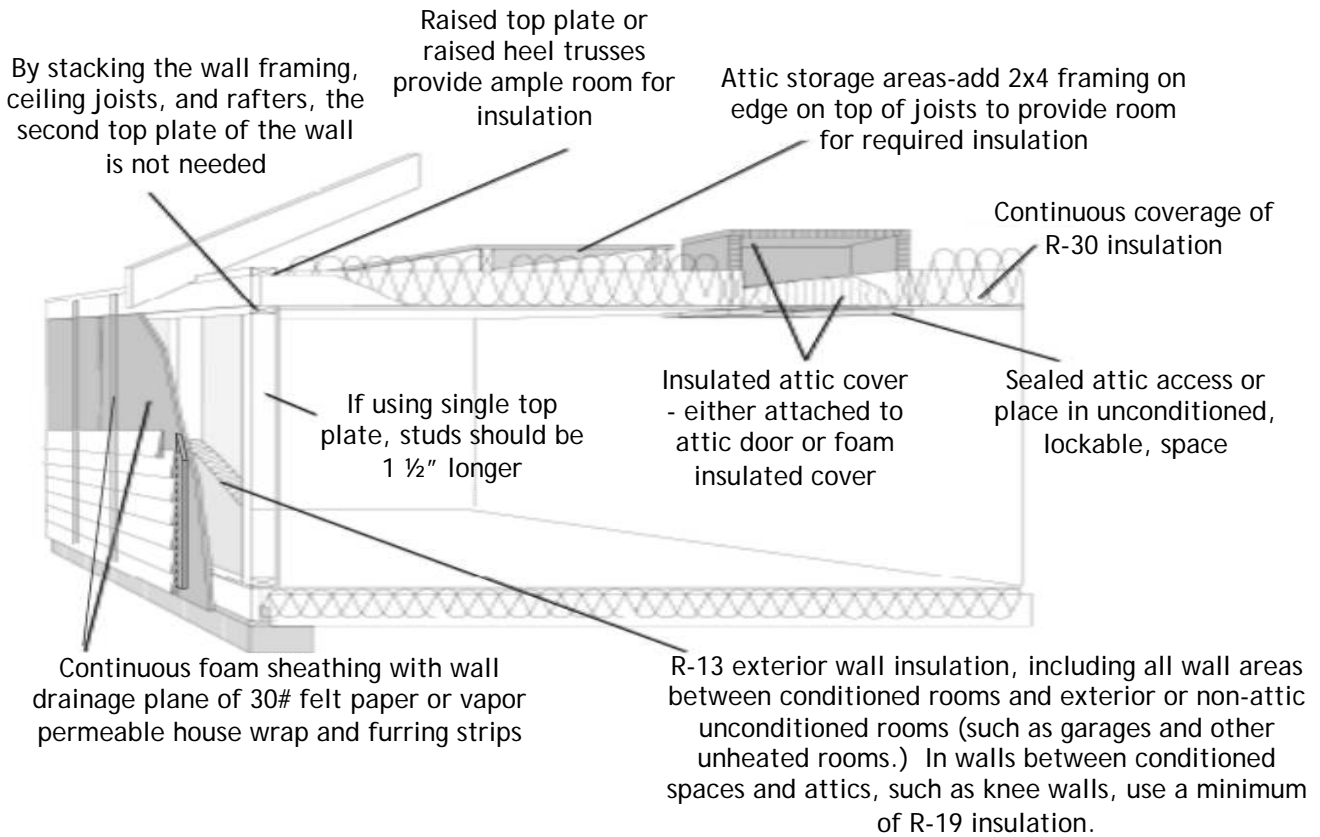

3. Attention to detail in sealing air leaks.

**Figure 3-3
Sealing Holes in Framing**

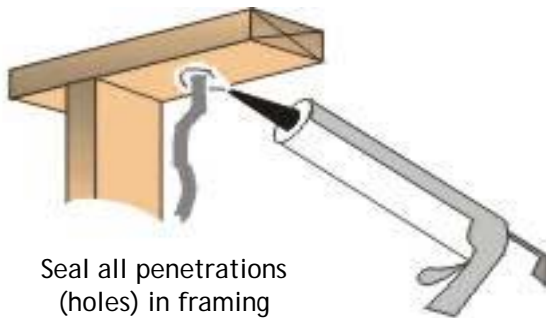

Caulk or foam all utility penetrations through the framing to reduce air infiltration caused by pressure imbalances between the conditioned envelope and outdoor air.

Figure 3-4
More Sealing Techniques

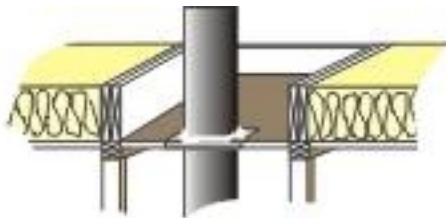
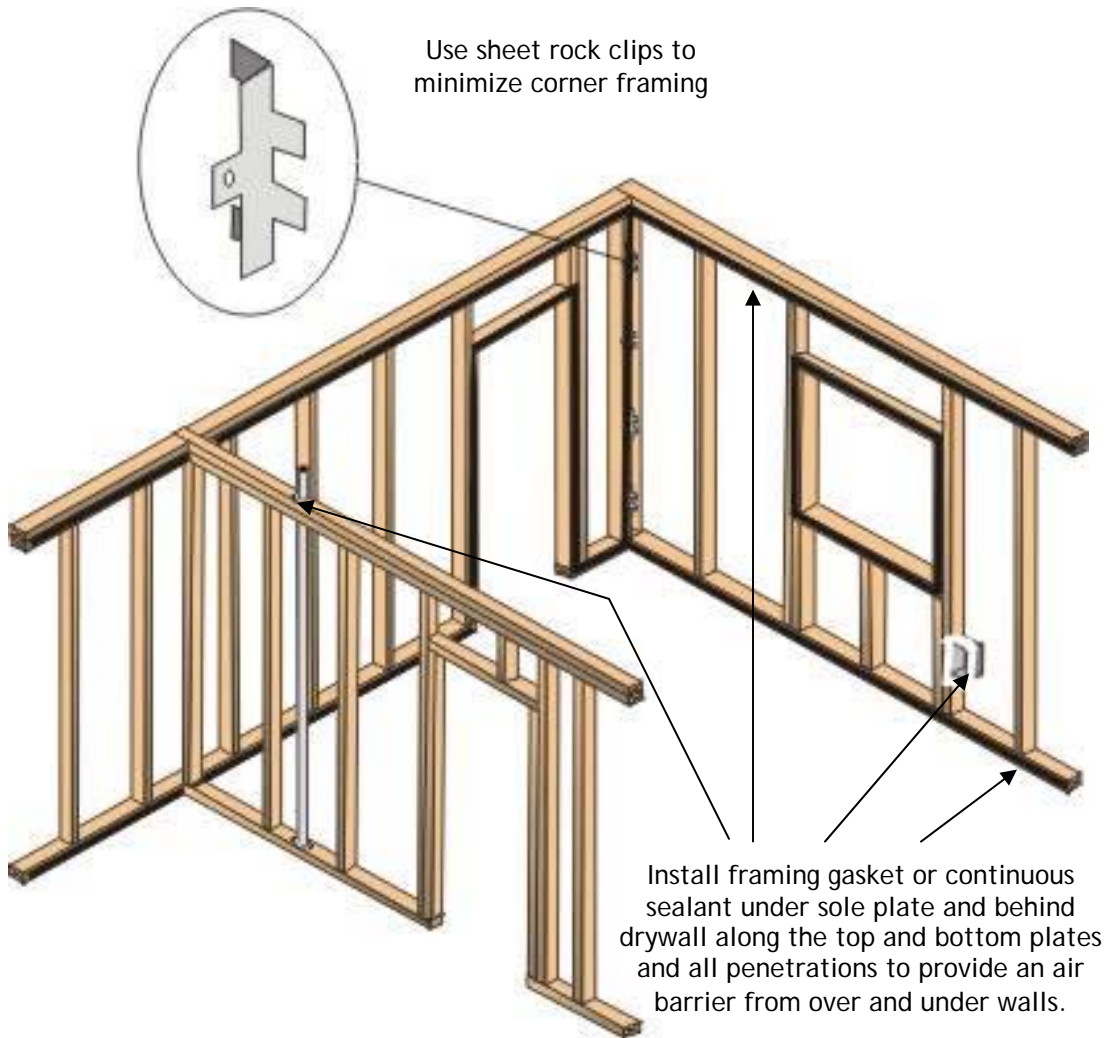

4. Design and installation of the heating and cooling equipment. Make sure that the HVAC contractor knows he is dealing with a well designed, energy efficient house before he sizes the equipment. Excessive air conditioning can cause moisture problems by cooling the air before it removes the moisture. This can cause moisture condensation in wall cavities, promoting the growth of mold inside walls and ducts. Many air handler cabinets come from the factory with leaks. Use mastic to seal holes and seams. Seal removable panels with approved metal duct tape.

- Effectiveness in sealing duct leaks. Well sealed ducts keep your conditioned air inside your dwelling rather than trying to cool the whole world. Cloth duct tape will fail too quickly to be used on ducts or air handlers. See Chapters 7 and 8 for more detail.

Economics of Energy Efficient Improvements

Unlike nice granite counter tops, energy efficiency features pay for themselves. World economics change and to set a price for any one feature and its value/savings is not possible. Prices shown below were representative when this book was written and illustrate how they can pay back their initial cost many times over. You will have to determine the cost at the time you build. If utility rates do not go up as expected, the payback will be longer.

All energy efficient features will produce a return on your investment, but sometimes you are better off investing the dollars in those features that will save you more or provide a higher return. Ways to determine this are shown later in this chapter.

The Energy Star Home

The criteria for an Energy Star Home is that it be at least 15% more efficient than a house built to the International Residential Code of 2003 and its supplement of 2004. The economic benefits for an Energy Star Home are seen in Tables 3-1 and 3-2. The minimum design requirements to meet the 2006 IRC, the Louisiana state building code, are shown in Table 3-3.

**Table 3-1
Estimated Extra Costs of a 2,000 sq ft Energy Star Home in Baton Rouge**

Energy Efficiency Improvement:	Unit Cost \$ (incremental)	Quantity	Total Estimated Cost
Attic- Increase insulation from R30 to R38 insulation of roof rather than ceiling with sealed attic	\$0.30/sq.ft.	2,000 sq.ft.	\$660
Seal air leakage to unconditioned space	\$0.20/sq.ft.	2,000 sq.ft.	\$400
Install fluorescent fixtures throughout home	\$31 each	12 lamps	\$372
Install Energy Star Appliances	\$200 each	4	\$800
Perform RESNET Energy Rating	\$200 each	1	\$200
Insulation wrap on water heater & hot pipes	\$100 each	1 unit	\$100
Perform ACCA Manual J, D and S to properly design the complete HVAC system	\$300 each	1	\$300
Upgrade HVAC system from SEER 13 to 14	\$600 each	1 unit	\$600
Install Heat Recovery Ventilation System	\$600 each	1 unit	\$600
Install humidistat controlled exhaust fans	\$200 each	2 units	\$400
Cost Subtotal			\$4,332
Savings from Properly designed HVAC*			(\$1,500)
Net Total Cost			\$2,932

*A properly designed HVAC system for a well insulated and sealed house including the above modifications can have a lower rated output with shorter duct runs, providing for a major cost reduction.

**Table 3-2
Energy Savings for an Energy Star Home**

Louisiana Code Home		Energy Star Home				
Year	Annual Energy* Cost	Annual Energy* Cost	Annual Energy Savings	Extra Mortgage Cost	Total Cost	Cumulative savings
1	1613	1371	242	581	-339	-339
2	1645	1398	247	81	166	-173
3	1678	1426	252	81	171	-2
4	1712	1455	257	81	176	173
5	1746	1484	262	81	181	354
6	1781	1514	267	81	186	541
7	1816	1544	273	81	192	732
8	1853	1575	278	81	197	929
9	1890	1606	284	81	203	1132
10	1928	1638	289	81	208	1340
15	2128	1809	319	81	238	2470
20	2350	1997	353	81	272	3760
25	2594	2205	389	81	308	5226
30	2864	2435	430	81	349	6887

*Energy prices are assumed to escalate 2% per year. Savings determined by RemRate modeling software based on Baton Rouge and prevailing utility rates. Your savings for the same design and equipment will vary. A home energy rater can provide more accurate results for your house design and location as well as advise you on other options.

**Table 3-3
Design Requirements to Meet the 2006 International Residential Code**

FEATURE:	Climate Zone 2	Climate Zone 3
Fenestration U-Factor	0.75	0.65
Skylight U-Factor	0.75	0.65
Glazed Fenestration SHGC	0.4	0.4
Ceiling R-Value	30	30
Wood Frame Wall R-Value	13	13
Mass Wall R-Value	4	5
Elevated Floor R-Value	13	19
Basement Wall R-Value	0	0
Slab R-Value and Depth	0	0
Crawl Space Wall R-Value	0	5

Evaluating Energy Efficient Products

The energy efficient builder seeks to minimize the lifetime costs of a home rather than the first cost. Making such calculations is often time-consuming and confusing. One of the best ways to determine whether an investment is sound is to compare the annual energy savings with the additional annual mortgage costs to find the Net Annual Savings.

Simple Payback

An example: suppose you want to know whether it is worthwhile to install efficient, low-e windows which use special coatings to reduce heat loss and gain. You receive the following information comparing low-e windows to plain double-glazed windows from a window dealer:

- Additional Cost for 20 Windows = \$500
- Annual Energy Savings = \$75

You can easily calculate that the simple payback period on the above investment is slightly less than 7 years ($500/75$). However, you are unsure whether the payback is acceptable.

Net Annual Savings

To find the Net Annual Savings, find the extra mortgage costs for the windows:

- Mortgage Interest Rate = 8.5%
- Term of Mortgage = 30 years
- Monthly Payment per \$1,000 (from Table 3-5 below) = \$7.69
- Annual Payment per \$1,000 (Monthly payment x 12 months/year)
= $\$7.69 * 12 = \92.28 per year for \$1,000 of principal
- Extra Annual Payment (multiply the additional cost of the windows by the above factor/1,000) = $\$500/\$1,000 * \$92.28 = \sim \46 per year mortgage payment
- Net Annual Energy Savings (subtract the annual payment from annual energy savings)
= $\$75 - \$46 = \$29$ annual savings

Since the Net Annual Energy Savings is positive, the investment is sound, especially when considering that energy costs will increase over time, while mortgage costs will remain constant.

Internal Rate of Return

It is often useful to calculate the Internal Rate of Return (IRR) for an energy investment. The IRR represents the interest rate you would have to receive on the amount to equal the savings generated by the energy efficiency you have invested in. Homeowners can compare the annual return from an energy measure to that earned by a typical financial investment at a bank. To find the IRR for the above example:

Find the payback period (divide the total cost by the annual savings) = $500/75 =$ about 7 years.

Determine the life of the energy measure in this case over 20 years.

To find the IRR, locate the row in Table 3-4 for the 7 year payback; then slide across to the 20-year column and find the IRR, which is 15% in this example (and it is tax free).

Note: A zero indicates the rate of return is either negligible or negative.
Energy prices are assumed to escalate 2% per year.

Table 3-4
Rate of Return for Energy Investments (%)

Simple Payback	Lifetime of Energy Investments (Years)			
	5	10	15	20
1.5	62%	68%	69%	69%
2	43%	51%	52%	52%
3	21%	33%	35%	35%
4	9%	23%	26%	27%
5	1%	17%	20%	21%
6	0%	12%	16%	18%
7	0%	9%	13%	15%
8	0%	6%	11%	13%
9	0%	4%	9%	11%
10	0%	2%	7%	10%
11	0%	0%	6%	8%
12	0%	0%	5%	7%
13	0%	0%	4%	6%
14	0%	0%	3%	6%
15	0%	0%	2%	5%
16	0%	0%	1%	4%
17	0%	0%	0%	3%
18	0%	0%	0%	3%
19	0%	0%	0%	2%
20	0%	0%	0%	2%

Mortgage Rate Tables

The following Table 3-5 shows the monthly payment for principal and interest for a \$1,000 loan at various interest rates and amortization periods. According to the chart, a mortgage of 20 years at 10% annual interest would have monthly payments of \$9.65 per \$1,000 of principal or 12 x 9.65= \$115.80 per year of payments per \$1,000 of principal.

If the extra energy features of a home cost an additional \$2,500, the extra annual mortgage would be:

$$\$2,500 \times \$115.80 / \$1,000 = \$289.50.$$

This approach is useful in comparing different methods of financing construction loans and permanent mortgages and their effect on the economics of energy efficient construction techniques.

Table 3-5
Mortgage Rate Table by Interest Rate by Term- \$/\$1000

	Years of Amortization							
	%	5	7	10	15	20	25	30
Annual Percentage Rate (APR)	5.00	18.87	14.13	10.61	7.91	6.60	5.85	5.37
	5.25	18.99	14.25	10.73	8.04	6.74	5.99	5.52
	5.50	19.10	14.37	10.85	8.17	6.88	6.14	5.68
	5.75	19.22	14.49	10.98	8.30	7.02	6.29	5.84
	6.00	19.33	14.61	11.10	8.44	7.16	6.44	6.00
	6.25	19.45	14.73	11.23	8.57	7.31	6.60	6.16
	6.50	19.57	14.85	11.35	8.71	7.46	6.75	6.32
	6.75	19.68	14.97	11.48	8.85	7.60	6.91	6.49
	7.00	19.80	15.09	11.61	8.99	7.75	7.07	6.65
	7.25	19.92	15.22	11.74	9.13	7.90	7.23	6.82
	7.50	20.04	15.34	11.87	9.27	8.06	7.39	6.99
	7.75	20.16	15.46	12.00	9.41	8.21	7.55	7.16
	8.00	20.28	15.59	12.13	9.56	8.36	7.72	7.34
	8.25	20.40	15.71	12.27	9.70	8.52	7.88	7.51
	8.50	20.52	15.84	12.40	9.85	8.68	8.05	7.69
	8.75	20.64	15.96	12.53	9.99	8.84	8.22	7.87
	9.00	20.76	16.09	12.67	10.14	9.00	8.39	8.05
	9.25	20.88	16.22	12.80	10.29	9.16	8.56	8.23
	9.50	21.00	16.34	12.94	10.44	9.32	8.74	8.41
	9.75	21.12	16.47	13.08	10.59	9.49	8.91	8.59
	10.00	21.25	16.60	13.22	10.75	9.65	9.09	8.78
	10.25	21.37	16.73	13.35	10.90	9.82	9.26	8.96
	10.50	21.49	16.86	13.49	11.05	9.98	9.44	9.15
	10.75	21.62	16.99	13.63	11.21	10.15	9.62	9.33
	11.00	21.74	17.12	13.78	11.37	10.32	9.80	9.52
	11.25	21.87	17.25	13.92	11.52	10.49	9.98	9.71
	11.50	21.99	17.39	14.06	11.68	10.66	10.16	9.90
	11.75	22.12	17.52	14.20	11.84	10.84	10.35	10.09
	12.00	22.24	17.65	14.35	12.00	11.01	10.53	10.29
	12.25	22.37	17.79	14.49	12.16	11.19	10.72	10.48
	12.50	22.50	17.92	14.64	12.33	11.36	10.90	10.67
	12.75	22.63	18.06	14.78	12.49	11.54	11.09	10.87
	13.00	22.75	18.19	14.93	12.65	11.72	11.28	11.06
	13.25	22.88	18.33	15.08	12.82	11.89	11.47	11.26
	13.50	23.01	18.46	15.23	12.98	12.07	11.66	11.45
	13.75	23.14	18.60	15.38	13.15	12.25	11.85	11.65
	14.00	23.27	18.74	15.53	13.32	12.44	12.04	11.85
	14.25	23.40	18.88	15.68	13.49	12.62	12.23	12.05
	14.50	23.53	19.02	15.83	13.66	12.80	12.42	12.25
	14.75	23.66	19.16	15.98	13.83	12.98	12.61	12.44
15.00	23.79	19.30	16.13	14.00	13.17	12.81	12.64	
15.50	24.05	19.58	16.44	14.34	13.54	13.20	13.05	
16.00	24.32	19.86	16.75	14.69	13.91	13.59	13.45	
16.50	24.58	20.15	17.06	15.04	14.29	13.98	13.85	
17.00	24.85	20.44	17.38	15.39	14.67	14.38	14.26	
17.50	25.12	20.73	17.70	15.75	15.05	14.78	14.66	
18.00	25.39	21.02	18.02	16.10	15.43	15.17	15.07	
18.50	25.67	21.31	18.34	16.47	15.82	15.57	15.48	
19.00	25.94	21.61	18.67	16.83	16.21	15.98	15.89	
19.50	26.22	21.91	19.00	17.19	16.60	16.38	16.30	
20.00	26.49	22.21	19.33	17.56	16.99	16.78	16.71	
20.50	26.77	22.51	19.66	17.93	17.38	17.19	17.12	
21.00	27.05	22.81	19.99	18.31	17.78	17.60	17.53	

Home Energy Features

A well-designed, energy efficient home requires close attention to detail on the parts of the builder and the designer. Insulation and high quality windows are not enough. To eliminate energy waste the homebuilder must have a well planned approach with careful management of details. The designer and builder should compare the initial cost of features to long term energy savings. Successful builders realize that efficiency not only saves money, but also improves the quality, comfort, and durability of the home. Quality construction reduces the builder's risk and liability; comfort provides a satisfied customer; and durability means fewer callbacks and higher profits.

Home Energy Features are a planning and marketing tool that can prove valuable to those involved in home construction and sales. Two typical levels of efficiency features are:

- Code – The construction of the home must meet the requirements of the 2006 version of the International Residential Code, which includes energy efficiency requirements based on the International Energy Conservation Code of 2006. It specifies insulation R factors for the attic, walls and the floor. It also affects the maximum allowable solar heat gain coefficient of the glass in fenestration and the allowable U factor of the building shell. It mandates the R value of the duct insulation (Louisiana amended this portion to a minimum of R-6). Such a home, if given an energy rating, could score 100 or better on the Residential Energy Services Network (RESNET) scale.
- Energy Star – A modest effort beyond the standard IRC 2006 Code requirements that includes a Home Energy Rating System (HERS) test of the home to determine the air infiltration and duct leakage of the home. To earn the ENERGY STAR, a home must meet guidelines for energy efficiency set by the U.S. Environmental Protection Agency. These homes are at least 15% more energy efficient than homes built to the [2004 International Residential Code \(IRC\)](#).
(http://www.energystar.gov/index.cfm?c=bldrs_lenders_raters.nh_IRC)



There are two ways to achieve Energy Star compliance. The first is a prescriptive list of components that may be picked from to complete the house. It is called the Builder Option Package (BOP). The second way, the National Performance Path, is performance based. If the complete house meets the 15% energy reduction goal, it qualifies, even if some of the components are not energy efficient. There are prescriptive parts, but it offers more flexibility in some areas. The National Performance Path requirements include a minimum number of Energy Star labeled light fixtures, appliances, etc., as well as a maximum allowable amount of duct leakage per square foot of conditioned space. These homes must have an Energy Star label on the breaker box showing that it has been energy rated by a certified RESNET Energy Rater. It must score no higher than an 85 index in Climate Zones 2 & 3.

Energy Star features go beyond simple conservation measures. The features, costs and energy savings of different systems are compared in Tables 3-6 and 3-7.

Special Note: Energy Star ratings are based on meeting basic performance required of the 2003 IRC and 2004 supplements, not the IRC 2006. However, Louisiana law requires the 2006 IRC version,

so the builder and the energy rater will have to take this into consideration when planning the home to meet either the Energy Star or the High Performance Homes.

**Table 3-6
IRC 2006 Code and Energy Star Homes for Climate Zones 2 & 3**

	IRC 2006 Code Minimum Compliant Home	Energy Star Home
RESNET Home Energy Rating Score	100+/- index	85 index
Insulation		
Ceiling or Roof Insulation -Zone 2 & 3	R-30	R-30
Raised Floor R Value -Zone 2 / Zone 3	R-19	R-13 / R-19
2x4 Wood Frame Wall R Value	R-13	R-13
Crawl Space Wall - Zone 3 Only	R-5 or 13	R-5 or 13
Infiltration Control Construction Systems		
2x4 Wood Frame	Standard Details w/ Batt or Cellulose	Energy Efficient Details w/ quality installation
Structural Insulated Panels (Option)	Exceeds Code	Continuous Air Barrier
Insulated Concrete Forms (Option)	Exceeds Code	Continuous Air Barrier
Windows and Doors (Fenestration)		
U Factor -Zone 2 / Zone 3	0.75 / .65	0.55
Solar Heat Gain Coefficient - both	0.4	0.35
Heating Ventilation and Air Conditioning		
Furnace (AFUE)	= 80	= 80
Heat Pump (HSPF)	= 7.7	= 8.2; EER = 11.5
Air Conditioner (SEER)	= 13	= 14; EER = 11.5
Ventilation	0.35 Natural Air Changes per Hour	Same
Thermostat Sizing	Standard not specified in La.	ENERGY STAR qualified Manual J required
Duct Work Leakage		
In a Vented Attic or Crawl Space	= 13 cfm/sf conditioned space	≤ 4 cfm to outdoors/100 sq. ft.
Non-vented Attic or Crawl Space	= 13 cfm/sf conditioned space	(waived if inside envelope)
Duct insulation Design	R-6 insulation not specified in La.	R-6 insulation Manual D required
Water Heating	Standard Storage Tank	Tankless (Option)
Lighting & Appliances		
Interior	Not defined	5 Energy Star fixtures or appliances minimum
Exterior	Not defined	>40 lumens per watt
Energy Rating Confirmed	None	Energy Star label

**Table 3-7
Economic Analysis of Energy Efficient Features**

Annual Energy Costs*		
	IRC 2006 Compliant Home	Energy Star Home
Heating	269	233
Cooling	339	301
Water Heating	303	251
Lighting	213	115
Other (Appliances; Service Charges)	593	590
Total	1717	1490
Annual Energy Savings		227
Total Additional Construction Costs		1710**
Extra Mortgage (\$/yr)		127**
Payback Period (years)		8.1**
Estimated Rate of Return (IRR)		14.9%**
*For a home with a 2,000 square-foot floor located in Baton Rouge. Analysis assumes 2% annual fuel price escalation; mortgage is 30-year, 7% loan; the energy savings were estimated using REMrate v.12.0 software.		
**Compared to IRC baseline compliant home.		

The energy efficiency features provide an excellent investment to the homeowner; the energy savings exceed the added annual mortgage costs incurred from the first year on.

One thing that builders must understand about high performance home design is that mechanical system designs must take into account the performance of the components of the building shell with regard to heat transfer, condensation, and vapor transmission.

For example, an old, poorly-insulated home with single pane, metal frame windows, leaky envelope, and a dark roof is considered. Combined with these deficiencies, a poorly planned return path to the air handler and poorly sealed and insulated ductwork in a vented attic or crawl space will require much more air conditioning tonnage to keep the home cool. If the ducts are in the attic, which can be over 140 degrees Fahrenheit in the summer, the conditioned air temperature from the air handler will rise. Also, the air that is leaked is lost to the surrounding environment, causing the air handler to draw outside ‘make-up’ air from unfiltered locations. This air is often filled with humidity, pollen, and pollution. Windows may form condensation on the outside because of the low thermal resistance through metal and glass.

Conversely, a high performance home with an air tight shell, well-insulated walls, roof or attic, and floor (if on piers), and high performance windows will not be losing its ‘cool’. Its duct work will be better sealed and have more insulation. If in a sealed, roof insulated attic or crawl space, the duct work can leak a small amount since the attic or crawl space is part of the conditioned envelope. A sealed, roof insulated attic will be only a few degrees different than the living space.

Building a much tighter and better insulated envelope means excess water vapor (latent load) must be removed for the comfort of the occupants. The builder/mechanical contractor can no longer base his sizing of the HVAC system or the duct runs on a ‘rule of thumb.’ He should employ Air Conditioning Contractors of America (ACCA) Manuals D-“Residential Duct Systems,” J-“Residential Load Calculation,” and S-“Residential Equipment selection,” to properly size the system for the latent load and the sensible load and plan the duct layout to move the correct amount of air into and out of each space. The equipment load will often be smaller and the ductwork shorter. The reduction in overall cost of the home and air conditioning system makes the owners’ time to recover his investment short. See Chapters 7 and 8 for more detail on this.

High Performance Homes – There are other construction systems that can reduce energy costs more than 30% compared to the standard 2006 IRC home. Such a home will have much tighter envelope, ductwork inside of the conditioned envelope, and a higher efficiency HVAC system than either the Energy Star or the 2006 IRC house. It may be built using sprayed foam as the sealing and insulation system, including between the roof rafters, in the walls, and under the floor if built off the ground. It may be built with foam core panel systems called Structural Insulated Panels (SIPS) or Insulated Concrete Forms (ICF). Both SIPS and ICF homes, when tested during a standard HERS rating for air infiltration, are several times tighter than a standard, wood frame home.

Due to the reduction in load combined with solar or wind power generation systems such a house may produce all the power needed to operate making it a “Net Zero” structure. “Net Zero” means that the energy used from the utility is replaced by the generation system(s) when they exceed the needs of the house. If not connected to the distribution system, it will have to have a battery bank or other storage device for those times when the sun isn’t shining or wind blowing adequately.

Figure 3-5
Typical Insulated Concrete Forms (ICF)

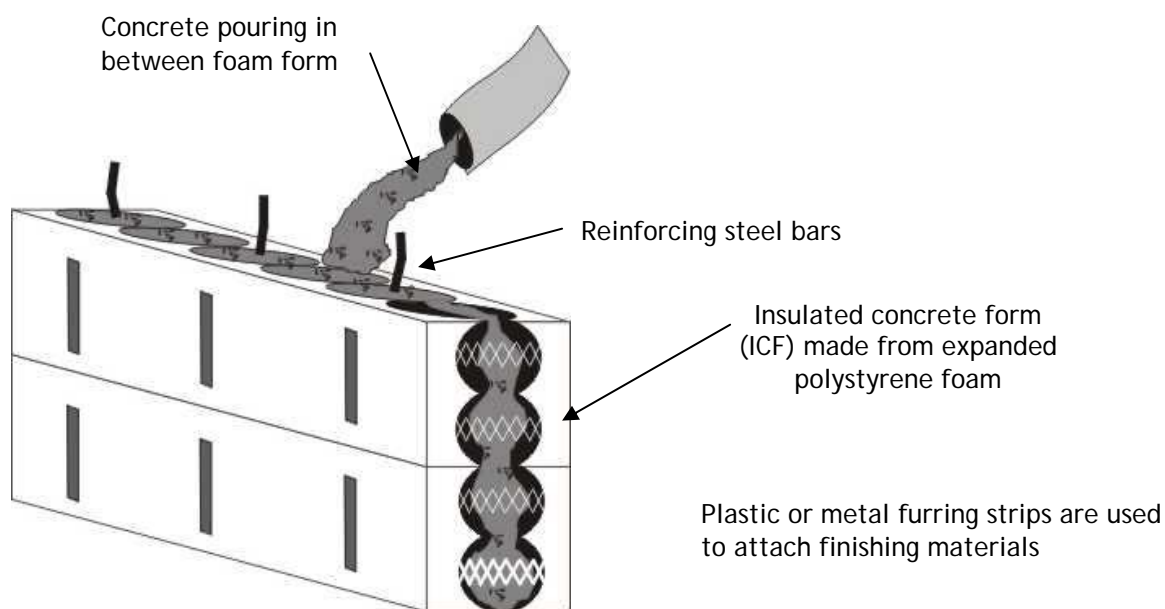
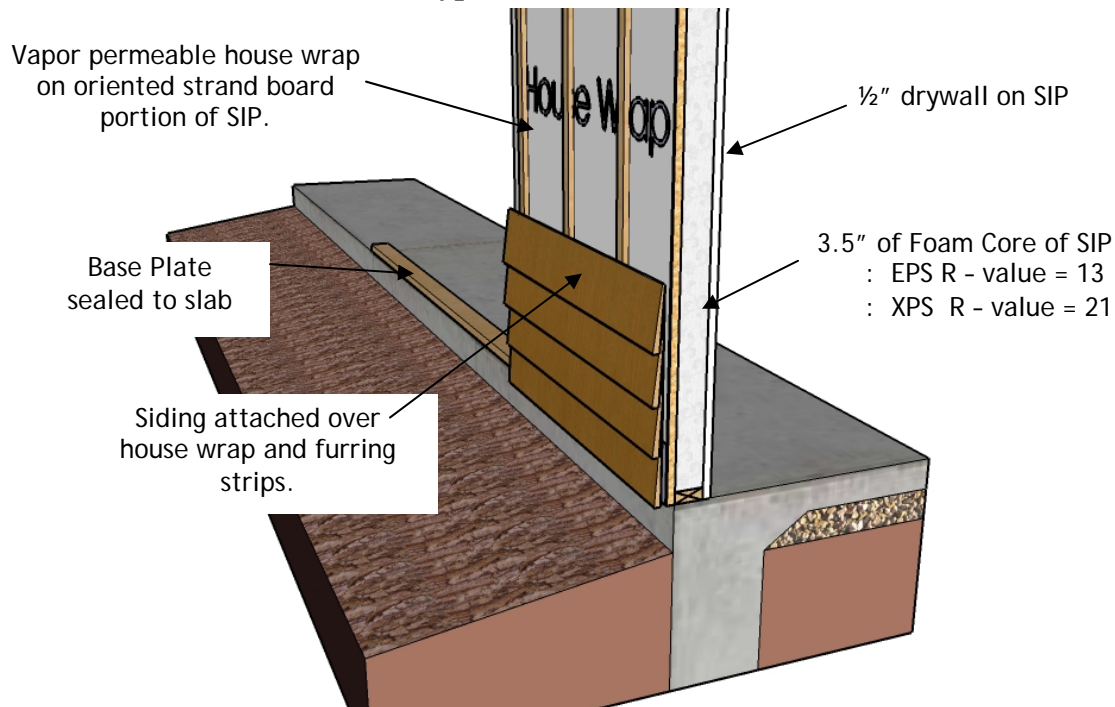

Figure 3-6
Typical Structural Insulated Panel



One side benefit of homes built with these two systems is that they are often much more wind resistant and secure from natural disasters. Wood or steel frame homes that have sprayed high density foam in the cavities of the walls, roofs, and floor joists, are significantly stronger than standard frame construction. The insulated concrete form homes are built with steel reinforced concrete that does not burn easily, will resist impact loads, and may be able to withstand tornadic winds. A home built with a structural insulated panel system is a much tighter and stronger home, as well. All of these with the foam insulation will more easily recover from flooding than fiberglass or cellulose insulated homes, since both of those insulation materials can hold large amounts of water.

Should you wish to build houses to a higher standard than the Energy Star criteria, please visit the following websites for more information:

Energy Efficiency and Renewable Energy at DOE

<http://www1.eere.energy.gov/buildings/residential/>

Hot and humid climates present several challenges for home building.

http://www1.eere.energy.gov/buildings/residential/hot_humid.html

The U.S. Department of Energy (DOE) has posed a challenge to the homebuilding industry - to build 220,000 high performance homes by 2012. The initiative is called the Builders Challenge, and homes that qualify must meet a 70 or better on the [EnergySmart Home Scale \(E-Scale\)](#). The E-Scale is a scale that allows homebuyers to understand - at a glance - how the performance of a particular home compares to that of others.

[EnergySmart Home](http://www1.eere.energy.gov/buildings/challenge/) <http://www1.eere.energy.gov/buildings/challenge/>

U.S. Green Building Association

The U.S. Green Building Council (USGBC) is a non-profit organization committed to expanding sustainable building practices. The Leadership in Energy and Environmental Design (LEED) Green Building Rating System™ encourages and accelerates global adoption of sustainable green building and development practices through the creation and implementation of universally understood and accepted tools and performance criteria. <http://www.usgbc.org/DisplayPage.aspx?CMSPageID=222>
Publications: <http://www.usgbc.org/Store/PublicationsList.aspx?CMSPageID=1518>

For those that are interested in building energy efficient homes that produce their own power and make little use of non-renewable resources, sometimes called “Green” Homes or “Sustainable” Homes, please visit the following websites:

PATH - The Partnership for Advancing Technology in Housing (PATH) is dedicated to accelerating the development and use of technologies that radically improve the quality, durability, energy efficiency, environmental performance, and affordability of America's housing. PATH is a voluntary partnership between leaders of the homebuilding, product manufacturing, insurance, and financial industries and representatives of [Federal agencies concerned with housing](#).
<http://www.pathnet.org/> .

ToolBase Services is the housing industry's resource for technical information on building products, materials, new technologies, business management, and housing systems. The [NAHB Research Center](#) provides the services, with funding from the Department of Housing and Urban Development (HUD) through [The Partnership for Advancing Technology in Housing \(PATH\)](#) program, and other industry sponsors. The Zero Energy Homes Project :
<http://www.toolbase.org/Home-Building-Topics/zero-energy-homes/seven-steps-zeh>

Appendix - Energy Star Homes Technical Resources

Guidelines for ENERGY STAR Qualified New Homes:

There are two ways to qualify a house for Energy Star’s guidelines for energy efficiency. Both paths require that the home must meet minimum requirements set forth by the Energy Star Thermal Bypass Checklist and that the finished house be tested by an independent, qualified Home Energy Rater. See http://www.energystar.gov/index.cfm?c=bldrs_lenders_raters.homes_guidelns for the most current required.

The Energy Star Thermal Bypass Checklist can be found at:

http://www.energystar.gov/index.cfm?c=bldrs_lenders_raters.thermal_bypass_checklist

The National Prescriptive Path: A Builder Option Package (BOP), where a builder constructs the home using a prescribed set of construction specifications that meet program requirements.

http://www.energystar.gov/ia/partners/bldrs_lenders_raters/downloads/Nat_BOP_Final_062807.pdf

The National Performance Path: A means to qualify a house based on its total efficiency verified by a home energy rating which uses software to model the home’s energy use showing that it meets a target energy efficiency score.

(http://www.energystar.gov/index.cfm?c=bldrs_lenders_raters.nh_HERS)

http://www.energystar.gov/ia/partners/bldrs_lenders_raters/downloads/PerfPathTRK_060206.pdf

ENERGY STAR Qualified Homes National Builder Option Package

ENERGY STAR Builder Option Package (BOP) requirements are specified in the table below.

To qualify as ENERGY STAR using this BOP, a home must meet the requirements specified, be verified and field-tested in accordance with the HERS Standards by a RESNET-accredited Provider, and meet all applicable codes.

Feature	Hot Climates 1 (2004 IRC Climate Zones 1, 2, 3)
Cooling Equipment (Where Provided)	Right-Sized ² : <ul style="list-style-type: none"> • ENERGY STAR qualified A/C (14 SEER / 11.5 EER); OR • ENERGY STAR qualified heat pump 3 (14 SEER / 11.5 EER / 8.2 HSPF)
Heating Equipment	• 80 AFUE gas furnace; OR • ENERGY STAR qualified heat pump 2, 3 (14 SEER / 11.5 EER / 8.2 HSPF); OR • 80 AFUE boiler; OR • 80 AFUE oil furnace
Thermostat 3	ENERGY STAR qualified thermostat (except for zones with radiant heat)
Ductwork	Leakage 4: ≤ 4 cfm to outdoors/100 sq. ft.; AND R-6 min. insulation on ducts in unconditioned spaces 5
Envelope	• Infiltration 6,7 (ACH50): 7 in CZ 2 6 in CZ 3; AND • Insulation levels that meet or exceed the 2004 IRC 8; AND • Completed Thermal Bypass Inspection Checklist 9
Windows	ENERGY STAR qualified windows or better (additional requirements for CZ 2)10, 11, 12
Water Heater 13	Gas (EF): 40 Gal = 0.61 60 Gal = 0.57 80 Gal = 0.53 Electric (EF): 40 Gal = 0.93 50 Gal = 0.92 80 Gal = 0.89 Oil or Gas 14: Integrated with space heating boiler
Lighting and Appliances 15,16	Five or more ENERGY STAR qualified appliances, light fixtures, ceiling fans equipped with lighting fixtures, and/or ventilation fans

ENERGY STAR Qualified Homes National Builder Option Package Notes

1. The appropriate climate zone shall be determined by the 2004 International Residential Code (IRC), Figure N1101.2.
2. Cooling equipment shall be sized according to the latest editions of ACCA Manuals J and S, ASHRAE 2001 Handbook of Fundamentals, or an equivalent procedure. Maximum oversizing limit for air conditioners and heat pumps is 15%. The following operating conditions shall be used in the sizing calculations and verified where reviewed by the rater:
 - i. Outdoor temperatures shall be the 99.0% and 1.0% design temperatures as published in the ASHRAE Handbook of Fundamentals for the home's location or most representative city for which design temperature data are available.
 - ii. Indoor temperatures shall be 75 F for cooling and 70 F for heating. Infiltration rate shall be selected as "tight", or the equivalent term. In specifying equipment, the next available size may be used. In addition, indoor and outdoor coils shall be matched in accordance with ARI standards.
3. Homes with heat pumps in Climate Zones 4 and 5 (Not applicable to Climate Zones 2 & 3)
4. Ducts must be sealed and tested to be ≤ 4 cfm to outdoors/100 sq. ft. of conditioned floor area, as determined and documented by a RESNET-certified rater using a RESNET-approved or equivalent ASTM-approved testing protocol. Duct leakage testing can be waived if all ducts and air handling equipment are located in conditioned space (i.e., within the home's air and thermal barriers) AND the envelope leakage has been tested to be ≤ 3 ACH50 OR ≤ 0.25 CFM 50 per sq. ft. of the building envelope.
5. EPA recommends, but does not require, locating ducts within the home's conditioned space (i.e., inside the air and thermal barriers), and using a minimum of R-4 insulation for ducts inside the conditioned space to prevent condensation.
6. Envelope leakage must be determined by a RESNET-certified rater using a RESNET-approved testing protocol.
7. To ensure consistent exchange of indoor air, whole-house mechanical ventilation is recommended, but not required.
8. Insulation levels of a home must meet or exceed Sections N1102.1 and N1102.2 of the 2004 IRC. These sections allow for compliance to be determined by meeting prescriptive insulation requirements, by using U-factor alternatives, or by using a total UA alternative. These sections also provide guidance and exceptions that may be used. However, note that the U-factor for steel-frame envelope assemblies addressed in Section N1102.2.4 shall be calculated using the ASHRAE zone method or a method providing equivalent results, and not a series-parallel path calculation method as is stated in the code. Additionally, Section N1102.2.2, which allows for the reduction of ceiling insulation in space constrained roof/ceiling assemblies, shall be limited to 500 sq. ft. or 20% of ceiling area, whichever is

less. In all cases, insulation shall be inspected to Grade I installation as defined in the RESNET Standards by a RESNET-certified rater, with the following exceptions:

- i. Rim/Band Joists - the interior sheathing/enclosure material is optional in all climate zones, provided insulation is adequately supported and meets all other requirements.
 - ii. Wall Insulation - the interior sheathing/enclosure material is optional in climate zones 1-3, provided insulation is adequately supported and meets all other requirements.
 - iii. Sealed, Unvented Attic/Roof Assemblies - the interior sheathing/enclosure material is optional in climate zones 1-3, provided insulation is adequately supported and meets all other requirements, including full contact with the exterior (roof) sheathing.
 - iv. Floor insulation over unconditioned basements or enclosed crawlspaces, either vented or unvented, need not be enclosed (though floor insulation over ambient conditions does).
9. The Thermal Bypass Inspection Checklist must be completed for homes to earn the ENERGY STAR label. The Checklist requires visual inspection of framing areas where air barriers are commonly missed and inspection of insulation to ensure proper alignment with air barriers, thus serving as an extra check that the air and thermal barriers are continuous and complete.
10. All windows and skylights must be ENERGY STAR qualified or meet all specifications for ENERGY STAR qualified windows. Windows in Climate Zones 2 must exceed ENERGY STAR specifications (CZ 2: U-value ≤ 0.55 and SHGC ≤ 0.35). Visit www.energystar.gov/windows for more information on ENERGY STAR qualified windows.
- i. Note that the fenestration requirements of the 2004 IRC do not apply to the fenestration requirements of the National Builder Option Package. Therefore, if UA calculations are performed, they must use the IRC requirements (with the exception of fenestration) plus the fenestration requirements contained in the national BOP. For more information, refer to the “Codes and Standards Information” document.
11. All decorative glass and skylight window area counts toward the total window area to above-grade conditioned floor area (WFA) ratio. For homes with a WFA ratio $>18\%$, the following additional requirements apply:
- i. In IRC Climate Zones 1, 2, and 3, an improved window SHGC is required, and is determined by:
 - a. Required SHGC = $[0.18 / \text{WFA}] \times [\text{ENERGY STAR SHGC}]$
 - ii. Where the ENERGY STAR SHGC is the minimum required SHGC of the climate-appropriate window specified in this BOP.

12. Up to 0.75% WFA may be used for decorative glass that does not meet ENERGY STAR requirements. For example, a home with total above-grade conditioned floor area of 2,000 sq. ft. may have up to 15 sq. ft. (0.75% of 2,000) of decorative glass.
13. To determine domestic hot water (DHW) EF requirements for additional tank sizes, use the following equations: Gas DHW $EF \geq 0.69 - (0.002 \times \text{Tank Gallon Capacity})$; Electric DHW $EF \geq 0.97 - (0.001 \times \text{Tank Gallon Capacity})$.
14. In homes with gas or oil hydronic space heating, water heating systems must have an efficiency ≥ 0.78 EF. This may be met through the use of an instantaneous water heating system or an indirect storage system with a boiler that has a system efficiency ≥ 85 AFUE. Homes with tankless coil hot water heating systems cannot be qualified using this BOP, but can earn the label using the ENERGY STAR Performance Path requirements.
15. Any combination of ENERGY STAR qualified products listed may be installed to meet this requirement. ENERGY STAR qualified ventilation fans include range hood, bathroom, and inline fans. ENERGY STAR qualified lighting fixtures installed in the following locations shall not be counted: storage rooms (e.g., closets, pantries, sheds), or garages. Eligible appliances include ENERGY STAR qualified refrigerators, dish washers, and washing machines. Further efficiency and savings can be achieved by installing ENERGY STAR qualified products, in addition to those required (e.g., additional lighting, appliances, etc.).
16. Efficient lighting fixtures represent a significant opportunity for persistent energy savings and a meaningful way to differentiate ENERGY STAR qualified homes from those meeting minimum code requirements. In 2008, EPA intends to propose and solicit industry comments on adding the ENERGY STAR Advanced Lighting Package (ALP) as an additional requirement for ENERGY STAR qualified homes in 2009. To learn more about the ALP, refer to www.energystar.gov/homes.

ENERGY STAR Qualified Homes National Performance Path Requirements:

To qualify as ENERGY STAR, a home must meet the minimum requirements specified below, be verified and field-tested in accordance with the RESNET Standards by a RESNET-accredited Provider, and meet all applicable codes.

Maximum HERS Index Required to Earn the ENERGY STAR in Climate Zone 2 and 3 is 85.

**Table 3-8
ENERGY STAR Mandatory Requirements**

Envelope ^{2,3,4}	Completed Thermal Bypass Inspection Checklist
Ductwork ^{5,6}	Leakage \leq 6 cfm to outdoors / 100 sq. ft.
ENERGY STAR Products ^{13,14}	Include at least one ENERGY STAR qualified product category: Heating or cooling equipment ⁷ ; OR Windows ⁸ ; OR Five or more ENERGY STAR qualified light fixtures ^{9,10} , appliances ¹¹ , ceiling fans equipped with lighting fixtures, and/or ventilation fans ¹²
ENERGY STAR Scoring Exceptions	On-site power generation may not be used to decrease the HERS Index to qualify for ENERGY STAR. A maximum of 20% of all screw-in light bulb sockets in the home may use compact fluorescent lamps (CFLs) to decrease the HERS Index for ENERGY STAR compliance. CFLs used for this purpose must be ENERGY STAR qualified.
Note: Due to the unique nature of some state codes and/or climates, EPA has agreed to allow regionally-developed definitions of ENERGY STAR in California, Hawaii, and the Pacific Northwest to continue to define program requirements. The States of Montana and Idaho may use either the requirements of the national program or the regionally-developed program in the Pacific Northwest.	

1. The appropriate climate zone for each building site shall be determined by the 2004 International Residential Code (IRC), Table N1101.2. The HERS Index must be calculated in accordance with the RESNET Mortgage Industry National Home Energy Rating Standards.
2. The Thermal Bypass Inspection Checklist must be completed for homes to earn the ENERGY STAR label. The Checklist requires visual inspection of framing areas where air barriers are commonly missed and inspection of insulation to ensure proper alignment with air barriers, thus serving as an extra check that the air and thermal barriers are continuous and complete.
3. Envelope leakage must be determined by a RESNET-certified rater using a RESNET-approved testing protocol.
4. To ensure consistent exchange of indoor air, whole-house mechanical ventilation is recommended, but not required.
5. Ducts must be sealed and tested to be \leq 6 cfm to outdoors / 100 sq. ft. of conditioned floor area, as determined and documented by a RESNET-certified rater using a RESNET-approved testing protocol. If total duct leakage is $<$ 6 cfm to outdoors / 100 sq. ft. of conditioned floor area, then leakage to outdoors does not need to be tested. Duct leakage testing can be waived if all ducts and air handling equipment are located in conditioned space (i.e., within the home's air and thermal barriers) AND the envelope leakage has been tested to be \leq 3 ACH50 OR \leq 0.25 CFM 50 per sq. ft. of the building envelope. Note that mechanical ventilation will be required in this situation.
6. EPA recommends, but does not require, locating ducts within conditioned space (i.e., inside the air and thermal barriers), and using a minimum of R-4 insulation for ducts inside conditioned space to prevent condensation.
7. All cooling equipment, regardless of whether it is used to satisfy the ENERGY STAR products requirement, must be sized according to the latest editions of ACCA Manuals J and S, ASHRAE 2001 Handbook of Fundamentals, or an equivalent computation procedure. Maximum oversizing limit for air conditioners and heat pumps is 15% (with the exception of heat pumps in Climate Zones 5 - 8, where the maximum oversizing limit is 25%). This can be accomplished either by the rater performing the calculations or reviewing documentation provided by the professional contractor or engineer who

calculated the sizing (e.g., HVAC contractor). The following operating conditions shall be used in the sizing calculations and verified where reviewed by the rater:

- i. Outdoor temperatures shall be the 99.0% and 1.0% design temperatures as published in the ASHRAE Handbook of Fundamentals for the home's location or most representative city for which design temperature data are available.
 - ii. Note that a higher outdoor air design temperature may be used if it represents prevailing local practice by the HVAC industry and reflects extreme climate conditions that can be documented with recorded weather data; Indoor temperatures shall be 75° F for cooling; Infiltration rate shall be selected as "tight", or the equivalent term.
 - iii. In specifying equipment, the next available size may be used. In addition, indoor and outdoor coils shall be matched in accordance with ARI standards.
8. Where windows are used to meet the ENERGY STAR qualified product requirement, they shall be ENERGY STAR qualified or meet all specifications for ENERGY STAR qualified windows. Additional information can be found at www.energystar.gov/windows.
 9. For the purposes of meeting the ENERGY STAR requirement, qualified lighting fixtures in the following locations cannot be counted: storage rooms (e.g., closets, pantries, sheds), or garages.
 10. Efficient lighting fixtures represent a significant opportunity for persistent energy savings and a meaningful way to differentiate ENERGY STAR qualified homes from those meeting minimum code requirements. In 2008, EPA intends to propose and solicit industry comments on adding the ENERGY STAR Advanced Lighting Package (ALP) as an additional requirement for ENERGY STAR qualified homes in 2009. To learn more about the ALP, refer to www.energystar.gov/homes.
 11. Eligible appliances include ENERGY STAR qualified refrigerators, dish washers, and washing machines.
 12. ENERGY STAR qualified ventilation fans include range hood, bathroom, and inline fans.
 13. Further efficiency and savings can be achieved by installing ENERGY STAR qualified products, in addition to those required (e.g., additional lighting, appliances, etc.). For more information, visit www.energystar.gov.
 14. In homes with heat pumps that have programmable thermostats, the thermostat must have "Adaptive Recovery" technology to prevent the excessive use of electric back-up heating.

Chapter 4

Air Leakage Sealing - Materials and Techniques

Air leakage is a major problem for both new and existing homes and can:

- Contribute 30 percent or more to heating and cooling costs
- Create comfort and moisture problems
- Draw in pollutants such as radon and mold
- Occur in openings which also serve as a prime entry for insects and rodents

To reduce air leakage effectively requires a *continuous air barrier system* (sometimes called an *air retarder system*) — a combination of materials linked together to create a tight building envelope. An air barrier also minimizes air currents through insulation, helping maintain R-values. The air barrier should minimize air leakage through the building envelope - the boundary between the conditioned portion of the home and the unconditioned area.

Most standard insulation products are not effective at sealing air leakage. The R-value for these materials may drop if air leaks through the material. Some spray applied insulation materials, such as higher density fiberglass, rock wool, cellulose, and foam can seal against air leakage. However, these materials are often only applied in framing cavities; therefore, additional air sealing must be done between framing components.

The builder should work with his or her own crew and subcontractors to seal all holes through the envelope. Then, he or she should install a continuous air barrier material, such as drywall or housewrap, around the envelope. It is critical in the air sealing process to use durable materials and install them properly.

The air barrier constitutes the pressure boundary of the home as discussed in Chapter 3. The pressure, moisture, and thermal boundaries should coincide: otherwise, cold winter air may leak past the insulation, or water vapor may enter an uninsulated space where it encounters building materials below the dew point. Always draw sections of your home similar to Figure 4-1 in order to locate the pressure boundary distinctly.

Figure 4-1
Creating a Pressure Boundary

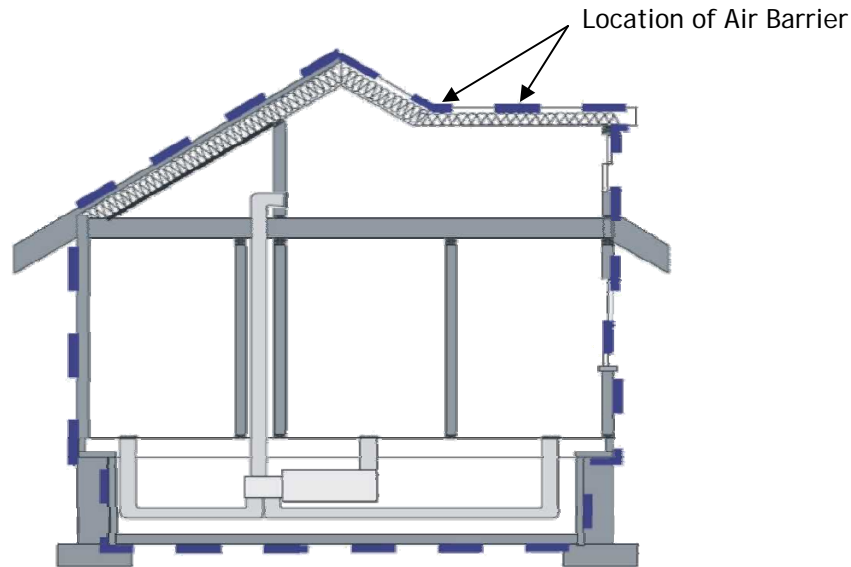

1. Install continuous Insulation
2. Seal penetrations and bypasses
3. Install and seal air-barrier material

Air Leakage Driving Forces

Air leakage requires two main ingredients:

- Holes - the larger the hole, the greater the air leakage. Large holes have higher priority for air sealing efforts.
- Driving force - a pressure difference that forces air to flow through a hole. Holes that experience stronger and more continuous driving forces have higher priority. The common driving forces are:
 - *wind* - caused by weather conditions
 - *stack effect* - upward air movement of warmer air
 - *mechanical blowers* - induced pressure imbalances caused by operation of fans and blowers

Wind is usually considered to be the primary driving force for air leakage. When the wind blows against a building, it creates a high pressure zone on the windward areas. Outdoor air from the windward side infiltrates into the building while indoor air exits on the leeward side. Wind acts to create areas of differential pressure which causes both infiltration and exfiltration. The degree to which wind contributes to air leakage depends on its velocity and duration.

Figure 4-2
Wind Driven Infiltration

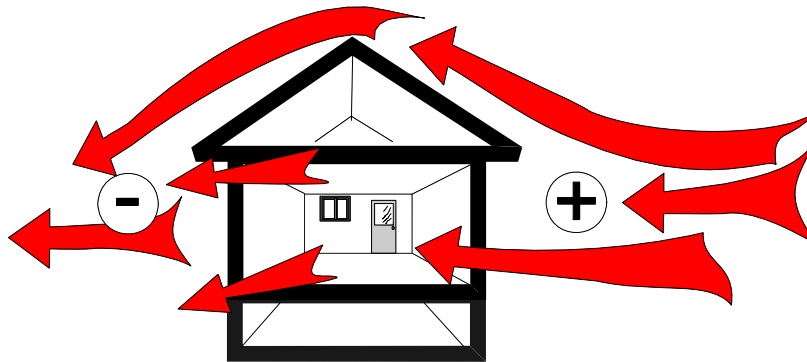

On average, wind may generate a pressure difference of 10 to 20 Pascals on the windward side. However; most homes have only small cracks on the exterior, and winds are variable.

Stack Effect: Heat transfer through the “envelope” causes warm air inside the home to rise and the heavier cool air to fall, creating a driving force known as the *stack effect*. The stack effect can vary from weak to strong, but is almost always present. Most homes have various sized holes leading into the attic and crawlspace or basement. Because the stack effect is so prevalent and the holes through which it drives air are often so large, it is usually a major contributor to air leakage, moisture, and air quality problems. Air may infiltrate at low elevations, and exfiltrate at upper elevations due to this effect. This brings in outside air at temperature and humidity level which is ambient. The HVAC may use far more energy. Air already heated or cooled may be forced to the outside in upper level holes or openings.

Figure 4-3
The Stack Effect

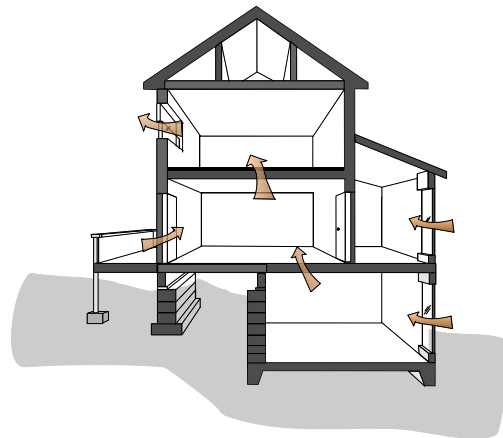

The stack effect can create pressure differences between 1 to 3 Pascals due to the power of rising warm air. Crawlspace and attic holes are often large.

Forced-air heating and cooling systems that are either poorly designed or installed can create three types of driving forces for air leakage:

- Suction pressures that pull outside air into return duct leaks.
- HVAC blower forces heated or cooled air out of the supply ductwork which ends up leaking to the exterior.
- Duct-related problems can create pressure imbalances in the home that increases air leakage through holes in the pressure boundary.

Figure 4-4
Mechanical System Driven Infiltration

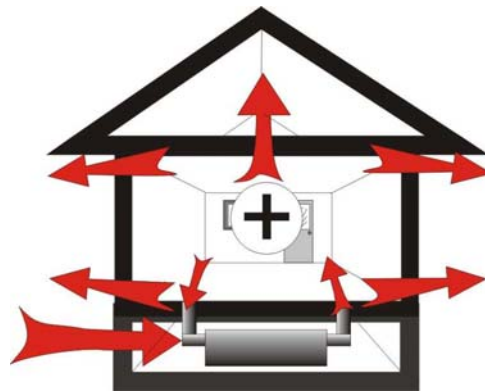

Leaks in supply and return ductwork can cause pressure differences of up to 30 Pascals. Exhaust equipment such as kitchen and bath fans and clothes dryers can also create pressure differences.

Measuring Air tightness with a Blower Door

While there are many well-known sources of air leakage, virtually all homes have unexpected air leakage sites called *bypasses*. These areas can be difficult to find and correct without the use of a *blower door*. This diagnostic device consists of a temporary door covering installed in an outside doorway and a fan which pressurizes (forces air into) or depressurizes (forces air out of) the building. When the fan operates, it is easy to feel air leaking through cracks in the building envelope. Blower doors have gauges which measure the building's air leakage rate.

One measure of a home's leakage rate is air changes per hour (ACH), which estimates how many times in one hour the entire volume of air inside the building leaks outside. To determine the number of air changes per hour, many experts use the blower door to create a negative pressure of 50 Pascals. A *Pascal* is a small unit of pressure — about 0.004 inches water gauge. A quarter resting on your hand exerts about 120 Pascals. Fifty Pascals is approximately equivalent to a 20 mile per hour wind. Energy efficient builders should strive for less than four air changes per hour when testing their home at 50 Pascals pressure (4ACH50). The rate of natural air changes per hour (NACH) can be estimated from the ACH50 and certain characteristics of the home.

Some building scientists use a different criterion — the air leakage rate per square foot of exterior envelope (CFM50/sq.ft.). The goal is often 0.30 CFM50/sq.ft. or less. An expert blower door technician can perform more advanced tests to find major sources of air leakage.

Table 4-1
Typical Infiltration Rates
 (in air changes per hour – ach)

	ACH50	NACH
Description	(blower door test result)	(natural rate)
New home with special airtight construction and controlled ventilation	0.5 - 2.5	0.03 - 0.15
Home with air barrier	3.0 - 5.0	0.15 - 0.3
Standard new home	7.0 - 15.0	0.4 - 1.0
Standard existing home	10.0 - 25.0	0.5 - 1.3
Older, leaky home	20.0 - 50.0	1.0 - 3.0

Figure 4-5
Blower Door

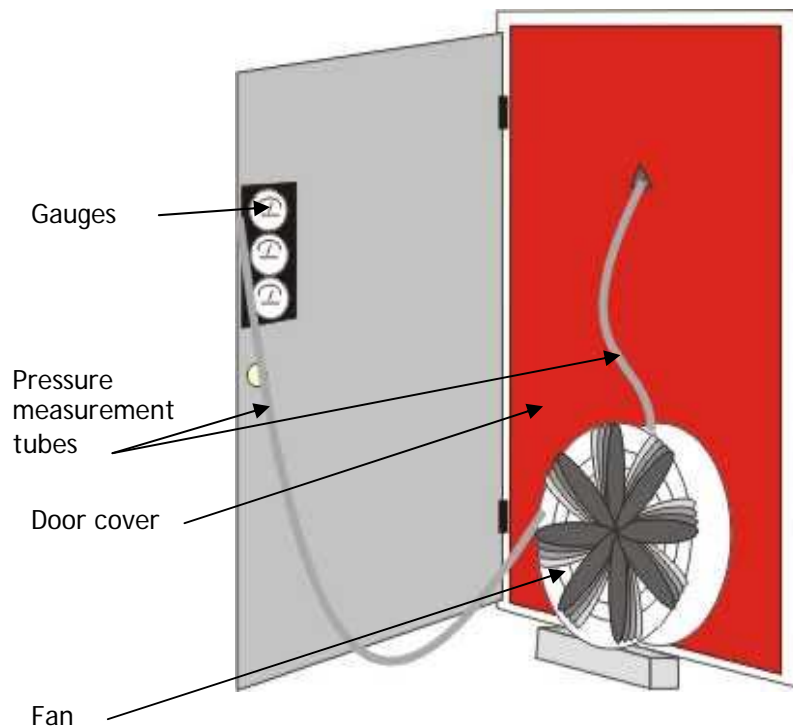
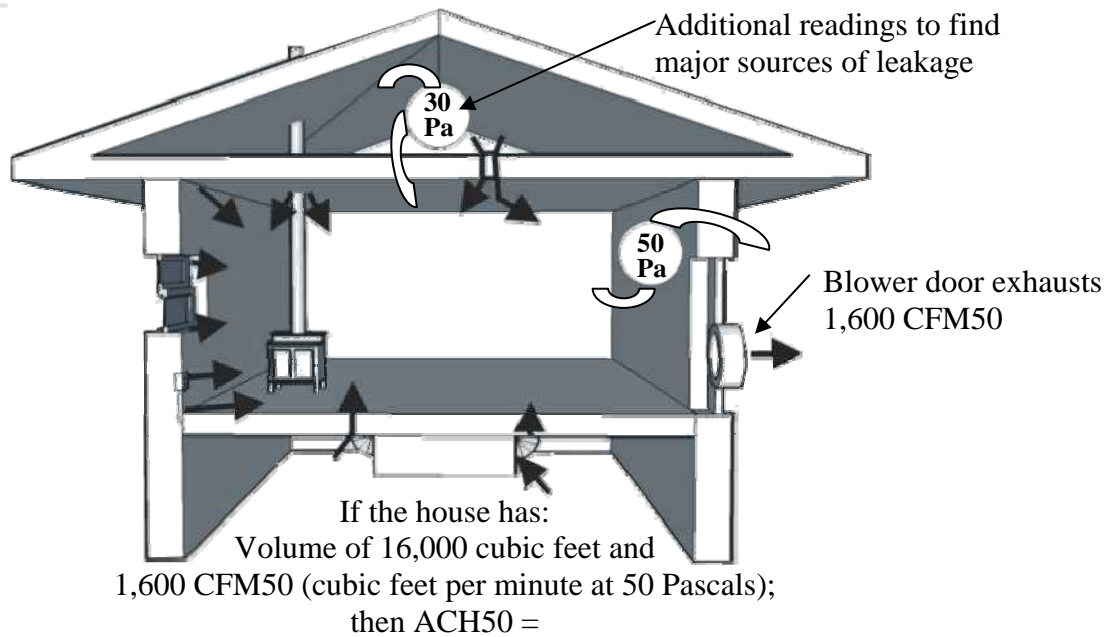

Figure 4-6
Home Blower Door Test



$$\frac{1,600 \text{ cfm}_{50} \times 60 \text{ minutes} / \text{hour}}{16,000 \text{ cubic feet Volume of house}} = 6 \text{ ACH}_{50}$$

Materials

Most air barrier systems rely on a variety of caulks, gaskets, weatherstripping, and sheet materials, such as plywood, drywall, and housewrap. The extra cost of these materials is usually under \$500 for standard house designs. Polyethylene can serve as an air barrier in addition to a vapor barrier; however, vapor barriers are not recommended for homes in Louisiana.

Seal Penetrations and Bypasses

The first step for successfully creating an air barrier system is to seal all of the holes in the building envelope. Too often, builders concentrate on air leakage through windows and doors and ignore areas of much greater importance. Many of the key sources of leakage — called *bypasses* — are hidden from view behind soffits over cabinets, behind bath fixtures, dropped ceilings, as well as chases for flues and ductwork, as shown in Figure 4-7. Attic access openings and whole house fans are also common bypasses. Sealing these bypasses is critical to reduce air leakage and maintain the performance of insulation materials.

Figure 4-7
Air Leakage through Bypass

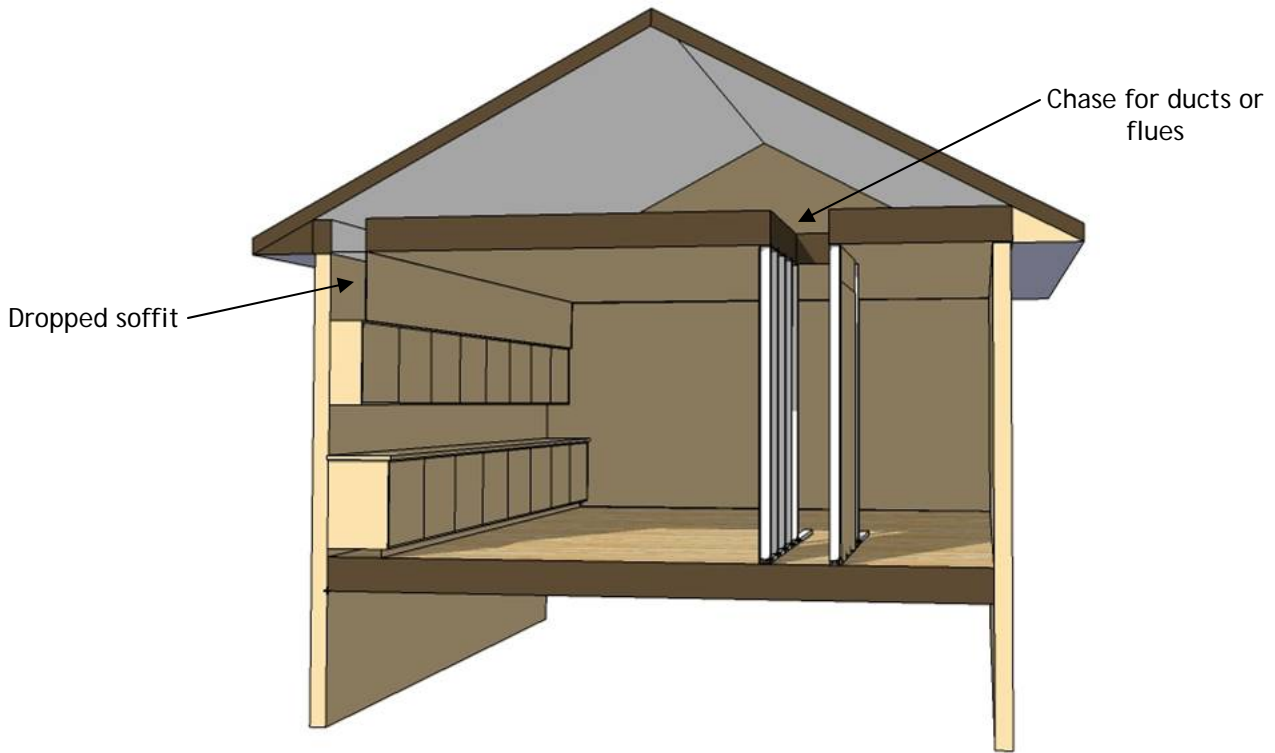

Figures 4-8, 4-9, and 4-10 show key areas that must be sealed to create an effective air barrier. The builder must clearly inform his or her subcontractors and workers of these details to ensure that the task is accomplished successfully. Make certain all sealants have at least 40-year service lives.

Table 4-2
Leaks and Sealants

Type of Leak	Commonly Used Sealants
Thin gaps between framing and wiring, pipes or ducts through floors or walls	40-year caulking; one part polyurethane is recommended
Leaks into attics, cathedral ceilings or wall cavities above first floor	Firestop caulking
Gaps, cracks or holes over 1/8 inch in width not requiring firestop sealant	Gasket, foam sealant, or stuffed with fiberglass or backer rod, and caulk on top
Open areas around flues, chases, plenums, plumbing traps, etc.	Attach and caulk a piece of plywood or foam sheathing material that covers the entire opening. Seal penetrations. If a flue requires a noncombustible clearance, use a noncombustible metal collar, sealed in place, to span the gap.
Final air barrier material	Use Airtight Drywall Method, continuous housewrap or other air barrier system.

Figure 4-8
Typical Home Air Leakage Sites

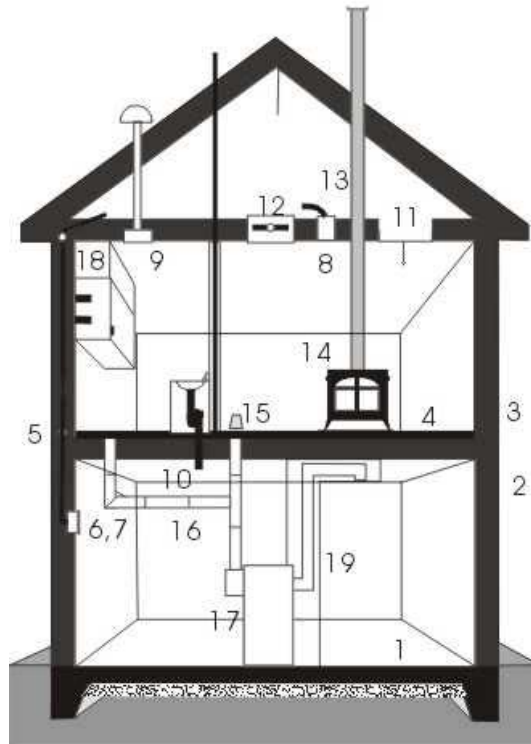

1. **Slab Floors** - seal all holes in the slab to prevent entry of water vapor and soil gas. A 4- to 6-inch layer of gravel under the slab is important to stop the seepage of water by capillary action.
2. **Sill Plate and Rim Joist** - seal all sill plates above basements and unvented crawlspaces. Seal rim or band joists between floors in multistory construction with caulking or gaskets.
3. **Bottom Plate** - use caulk or gasket between the plate and subflooring (or slab).
4. **Subfloor** - use an adhesive to seal the seams between pieces of subflooring.
5. **Electrical Wiring** - use wire-compatible caulk or spray foam to seal penetrations.
6. **Electrical Boxes** - use approved caulk or tape to seal around wiring holes of electrical boxes. Seal between the interior finish material and boxes.
7. **Electrical Box Gaskets** - caulk foam gaskets to all electrical boxes in exterior and interior walls before installing cover plates.
8. **Recessed Light Fixtures** - consider using surface-mounted light fixtures rather than recessed lights. When used, specify airtight models rated for insulation contact (IC).
9. **Exhaust Fans** - seal between the fan housing and the interior finish material. Choose products with tight-fitting backdraft dampers.

10. **Plumbing** - locate plumbing in interior walls, and minimize penetrations. Seal all penetrations with foam sealant or caulk.
11. **Attic Access** - weatherstrip attic access openings. For pull-down stairs, use latches to hold the door panel tightly against the weatherstripping. Cover the attic access opening with an insulated box.
12. **Whole House Fan** - use a panel made of rigid insulation or plastic to seal the interior cover or a box made from duct board to seal on top.
13. **Flue Stacks** - install a code-approved flue collar and seal with fire-rated caulk.
14. **Combustion Appliances** - closely follow local codes for fire stopping measures, which reduce air leakage as well as increase the safety of the appliance. Make certain all combustion appliances, such as stoves, inserts, and fireplaces, have an outside source of combustion air and tight-fitting dampers or doors.
15. **Return and Supply Registers** - seal all boots connected to registers or grilles to the interior finish material.
16. **Ductwork** - seal all joints in supply and return duct systems with mastic.
17. **Air Handling Unit** (for heating and cooling system) — seal all joints and holes with mastic. Seal service panels with tape.
18. **Dropped Soffit** - use sheet material such as drywall and sealant to stop leaks from attic into the soffit or wall framing; then insulate.
19. **Chases** (for ductwork, flues, etc.) - prevent air leakage through these bypasses with approved sheet materials and sealants.

Figure 4-9
Sealing Bypasses

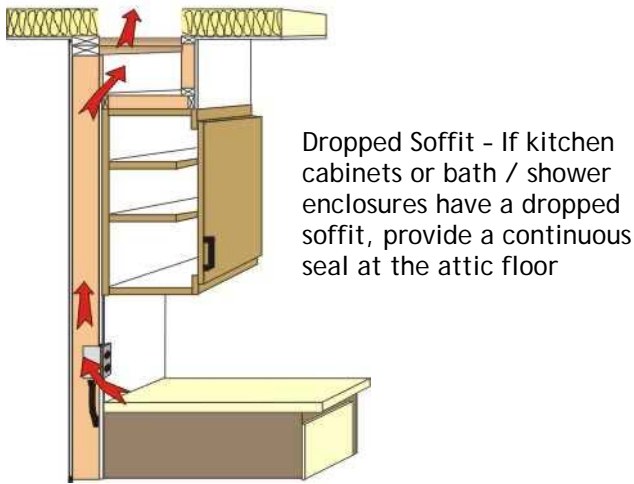

Plumbing - Seal penetrations, especially under bathtubs and other fixtures. Install drywall or housewrap behind bathtub to provide an air barrier.

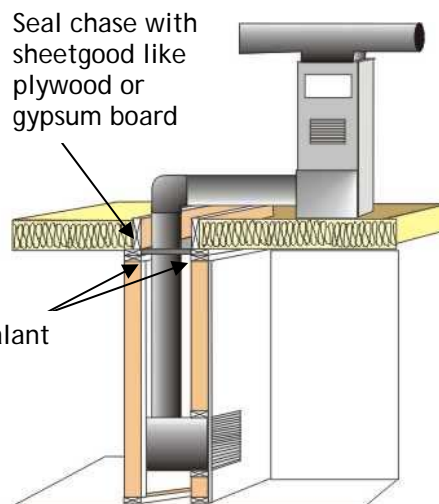
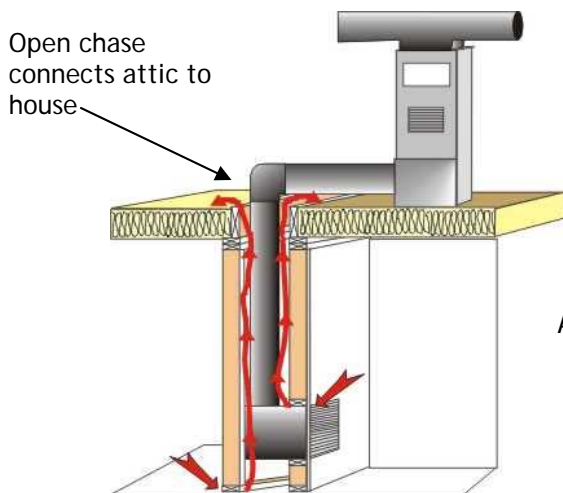
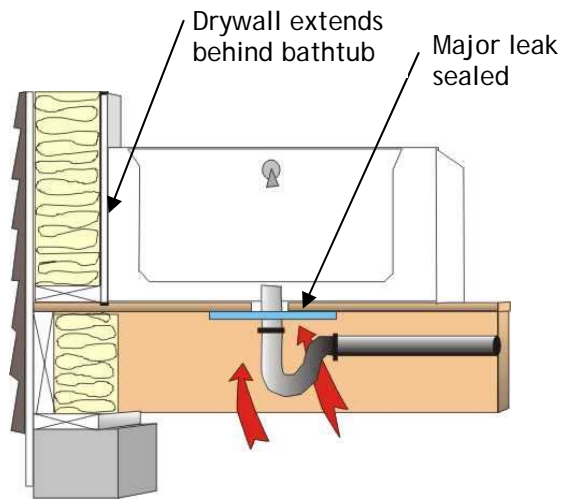
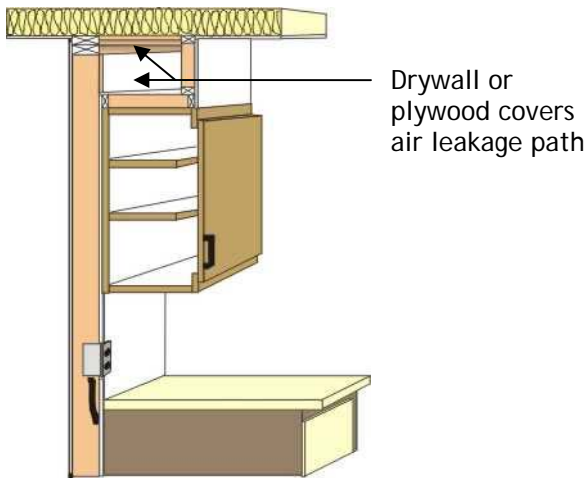
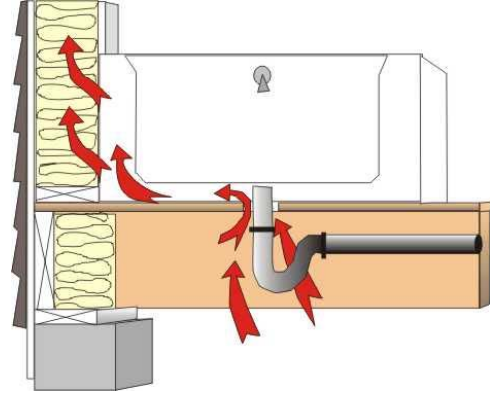

Return and Supply Plenums - Seal framed areas for ductwork.

Figure 4-10
Sealing More Bypasses

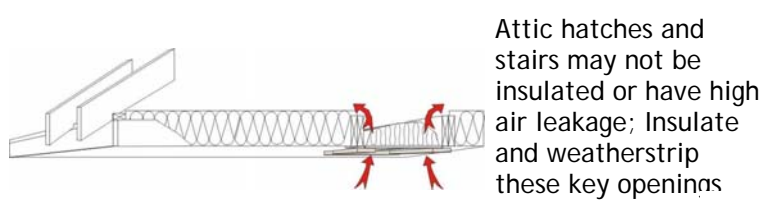
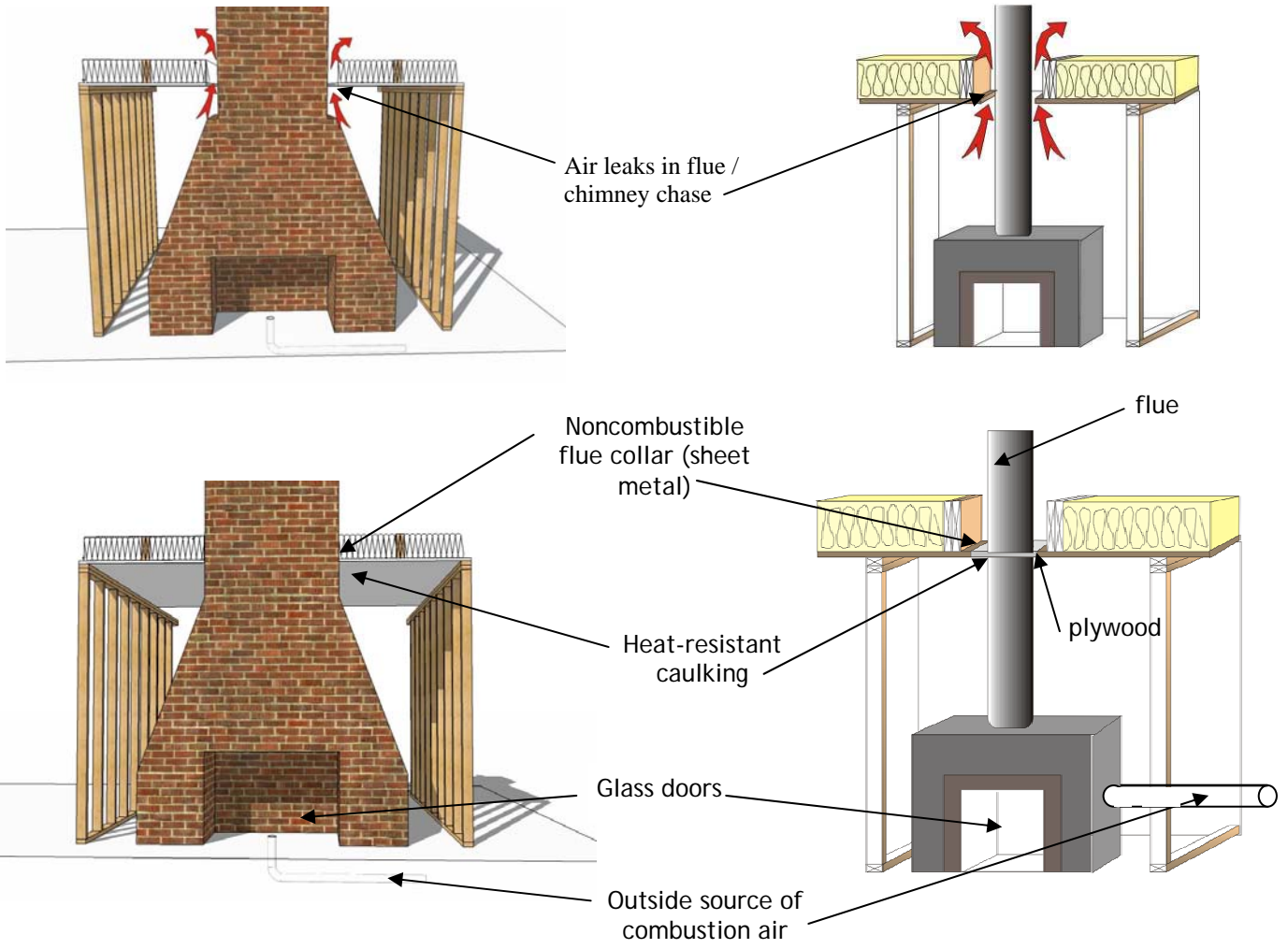

Attic hatches and stairs may not be insulated or have high air leakage; Insulate and weatherstrip these key openings

Standard recessed lights cannot be insulated and suffer substantial air leakage; Install IC (insulated contact), air tight recessed fixtures

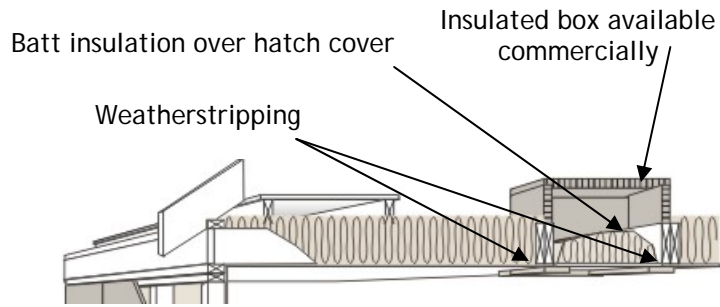

Or Install outside the conditioned space

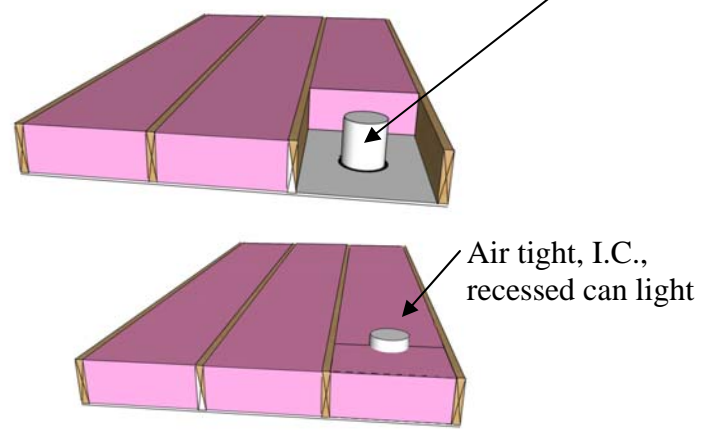

Airtight Drywall Method

The Airtight Drywall Method (ADM) is an air sealing system that connects the interior finish of drywall and other building materials together to form a continuous barrier. ADM has been used on hundreds of houses and has proven to be an effective technique to reduce air leakage as well as keep moisture, dust, and insects from entering the home.

In a typical drywall installation, most of the seams are sealed by tape and joint compound. However, air can leak in or out of the home in the following locations:

- Between the edges of the drywall and the top and bottom plates of exterior walls
- From the attic down between the framing and drywall of partition walls.
- Between the window, door frames and drywall
- Through openings in the drywall for utilities and other services

Figure 4-11
Airtight Drywall Method Air Barrier

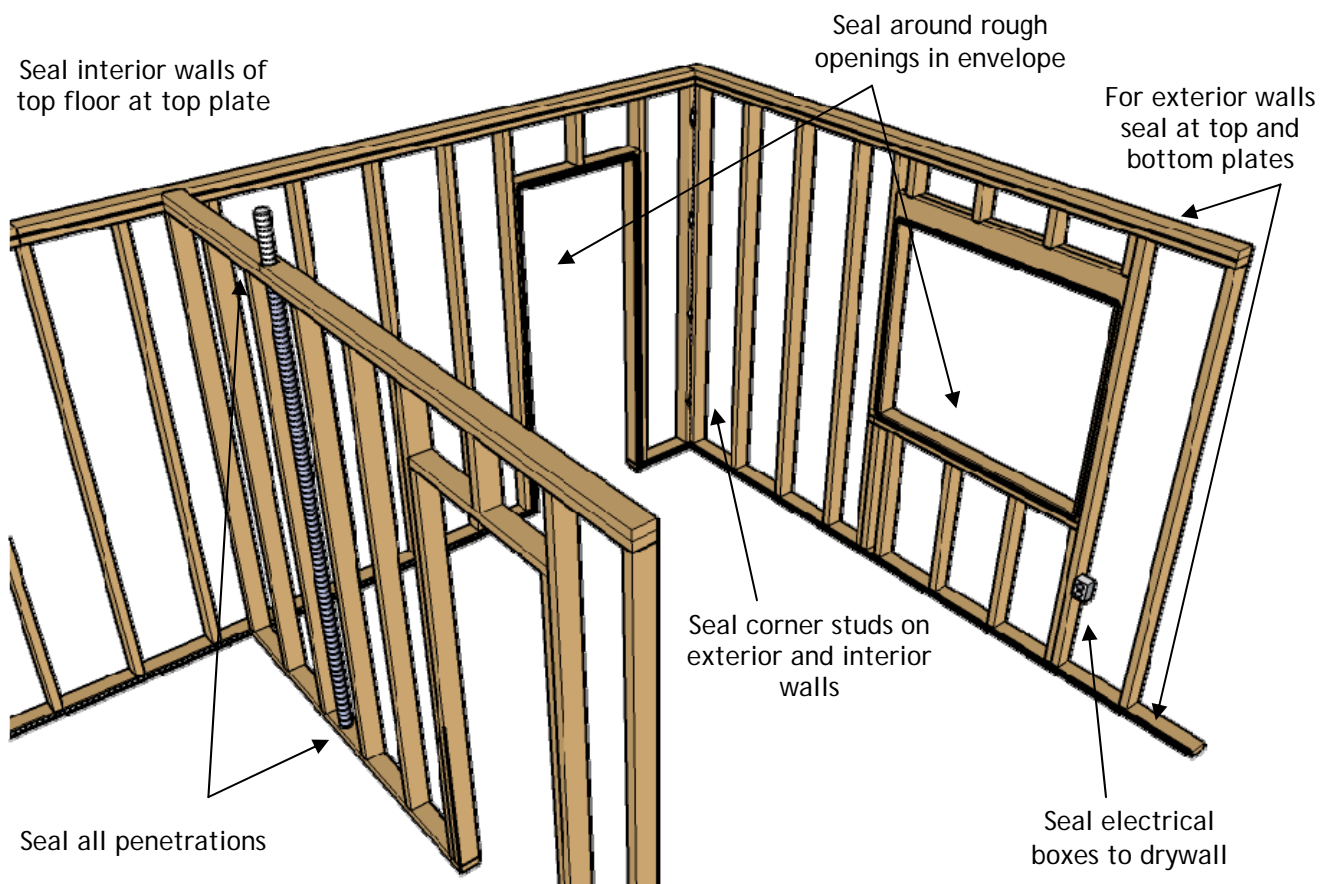

ADM uses either caulk or gaskets to seal these areas and make the drywall a continuous air barrier system. ADM gaskets are pliable materials with “memory” – when compressed and then released by drywall that is shrinking or expanding. They quickly return to their previous shape and position. The gaskets can be applied long before the drywall crew arrives – just make sure they do not remove the gaskets.

ADM Advantages

Effective - ADM is a reliable air barrier.

Simple - does not require specialized subcontractors or unusual construction techniques. If gasket materials are not available locally, they can be shipped easily.

Does not cover framing - the use of ADM does not prevent the drywall from being glued to the framing.

Scheduling - gaskets can be installed anytime between when the house is “dried-in” and the drywall is attached to framing.

Adaptable - builders can adapt ADM principles to suit any design and varying constructions schedules.

Cost - materials and labor for standard designs should only cost \$100 - \$300.

Not a vapor barrier - Vapor barriers are not recommended in climate zones 2 and 3; such as in Louisiana.

ADM Disadvantages

New - although ADM is a proven technique, many building professionals and code officials are not familiar with its use.

Requires thought - while ADM is simple, new construction techniques require careful planning to ensure that the air barrier remains continuous. However, ADM is often the most error-free and reliable air barrier for unique designs.

Requires care - gaskets and caulking can be damaged or removed by subcontractors when installing the drywall or utilities.

Figure 4-12
Creating an Air Barrier Between Floors

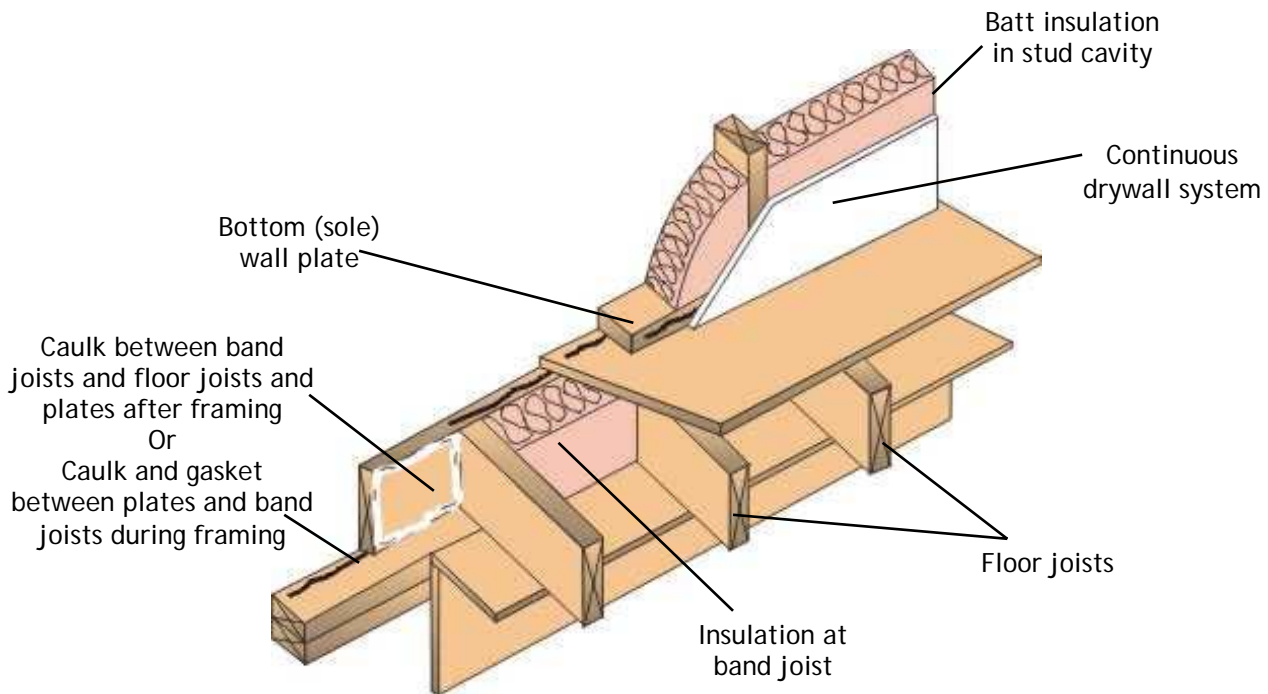

ADM Installation Techniques

Wood Framed Floors

- Seal seams in and around the band joist to minimize air leakage.
- For unvented crawlspaces or basements, seal or gasket beneath the sole plate.
- Seal the seams between pieces of subflooring with good quality adhesive.

Slab Floors

- Seal expansion joints and penetrations with a sealant such as one-part urethane caulk.

Windows and Doors

- Seal drywall edges to either framing or jambs for windows and doors.
- Fill rough opening with dry foam gasket or nonexpanding caulk, spray foam sealant, or suitable substitute.
- Caulk window and door trim to drywall with clear or paintable sealant.

Exterior Framed Walls

- Seal between the bottom plate and subflooring with caulk or gaskets.

- Install ADM gaskets or caulk along the face of the bottom and top plate so that when drywall is installed it compresses the sealant to form an airtight seal against the framing.
- Use drywall joint compound or caulk to seal the gap between drywall and electrical boxes; install foam gaskets behind cover plates and caulk holes in boxes.
- Homes in Louisiana do ***not*** need a vapor barrier. Sealing air leaks is more effective as moisture control.
- Seal penetrations through the top and bottom plates for plumbing, wiring, and ducts; local fire codes may require fire stopping for penetrations through top plates.

Partition Walls

- Seal the drywall to the top plate of partition walls where attics and other unconditioned spaces are above.
- Install gaskets or caulk on the face of the first stud in the partition wall. Sealant should extend from the bottom to the top of the stud to keep from leaking inside or outside.
- Seal around ductwork where it projects through partition walls.
- Seal penetrations through the top and bottom plates for plumbing, wiring, and ducts.

Ceiling

- Seal openings above or into chases and dropped soffits.
- Follow standard finishing techniques to seal the junction between the ceiling and walls.
- When installing ceiling drywall, do not damage ADM gaskets on wall studs, especially in tight areas such as closets and hallways.
- Seal all penetrations in the ceiling for wiring, plumbing, ducts, attic access openings, and whole house fans.
- Avoid recessed lights; where used, install airtight, IC-rated fixtures and caulk or gasket between fixtures and drywall.

Housewrap Air Barriers

Housewrap materials can reduce air leaks through exterior walls if installed properly. They are advantageous in Louisiana because they are permeable to water vapor, thus helping prevent moisture buildup in walls.

One of the major problems with housewraps has been poor field installation. In fact, many homes with exterior housewraps do not reap the full energy savings because of sub-par installation. To stop air leakage, the housewrap material must be sealed to the sheathing at framing openings, all

penetrations and seams. Follow manufactures recommendations. Check perm rating to ensure that the material is not a vapor barrier (< 1 perm).

Figure 4-13
Housewrap – Window Connection

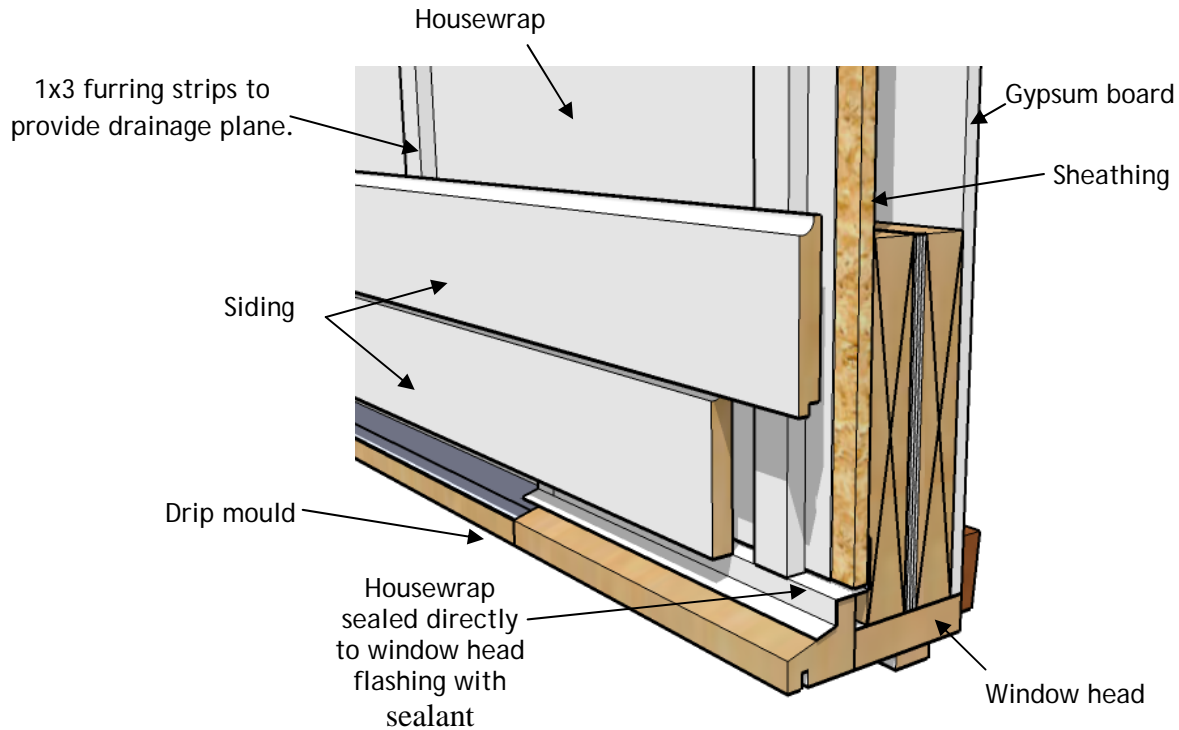

Housewrap Advantages

Air barrier - housewraps allow water vapor to pass through.

Availability - housewraps have been used for years on homes and are usually available in local building supply houses.

Installation - housewraps require no special tools and can be installed in large sheets with relatively few joints. Tears can be repaired with approved tapes.

Cost - materials and labor for completely air sealing standard home designs should only cost a few hundred dollars.

Marketing - the visibility of housewraps help advertise the home as "energy efficient".

Housewrap Disadvantages

Sealing penetrations and seams - it can be difficult to seal housewraps to plumbing, wiring, and ducts; between overlapped seams; and at the junctions between floors, walls and ceilings. Many standard caulks do not provide an effective, long-term seal, so select products with 30 to 50-year guarantees.

Connection to floor and ceiling - housewraps can seal air leaks through exterior walls easily, but the builder must take care to connect the seal membrane over sheathing at ceiling and floor assembly areas.

Figure 4-14
Recommended Housewrap
Installation Process & Procedures

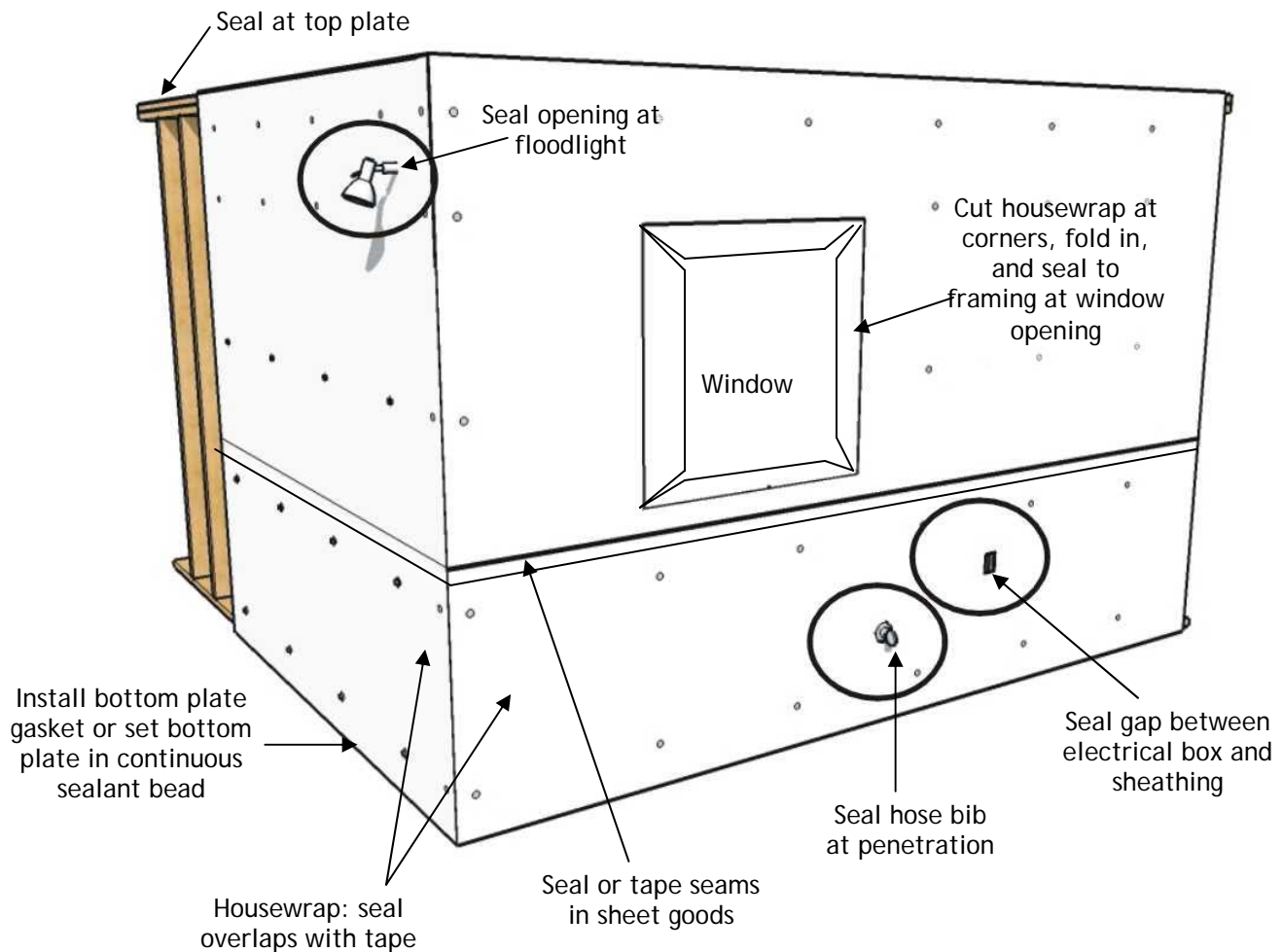

Foam Sheathing Barrier

Foam exterior sheathing can serve as both insulation and an exterior drainage plane. Detailing is, of course, critical especially at joints and penetrations. All seams should be sealed, as shown in Figure 4-15. Horizontal seams must be flashed with Z-flashing or comparable sealants.

The exterior sheathing material can either serve as a moisture shedding / air sealing membrane or as a moisture absorbing surface that may contribute to the degradation of the building envelope.

Figure 4-15
Sealing Sheathing as Exterior Air Barrier

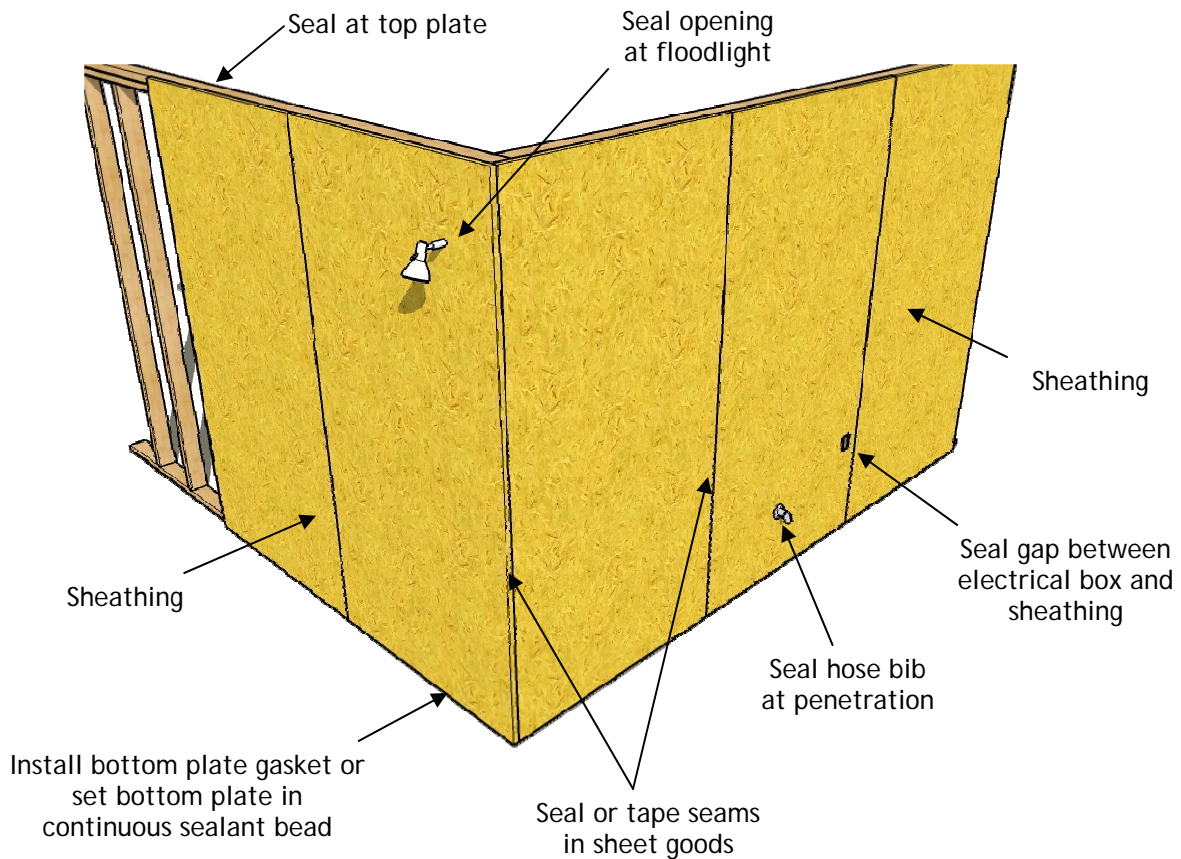

The keys to having a beneficial sheathing surface are:

- Protect sheathing materials, such as OSB, plywood, and exterior dry wall that will degrade with exposure to sun, water, or other environmental hazards.
- Always lap protective materials such as housewrap and exterior felt higher over lower courses (shingle style) to shed water.
- Do not use tape to seal horizontal seams, install flashing instead.

Provide moisture and vapor a place from which to escape — a drain for moisture at the bottom and a vent for removing vapor at the top of the wall.

It is important in Louisiana to allow the wall to dry — usually by eliminating the interior vapor barrier and allowing water vapor to move through the wall cavity, into the home to be removed from the home (in liquid form) through the condensate pan drain in the air handler. Avoid applying vinyl wall coverings and other interior vapor barrier materials on exterior walls in this hot – humid climate. High humidity areas like baths and kitchens need special treatment, like exhausting vapor laden air.

Notes:

Notes:

Chapter 5

Insulation Materials and Techniques

The key to an effective insulation system is proper installation of quality insulation products. A house should have a continuous layer of insulation around the entire building envelope. Studies show that improper installation can cut performance of the insulation by 30% or more.

Figure 5-1
Insulating the Building Envelope
Recommended Insulation Values

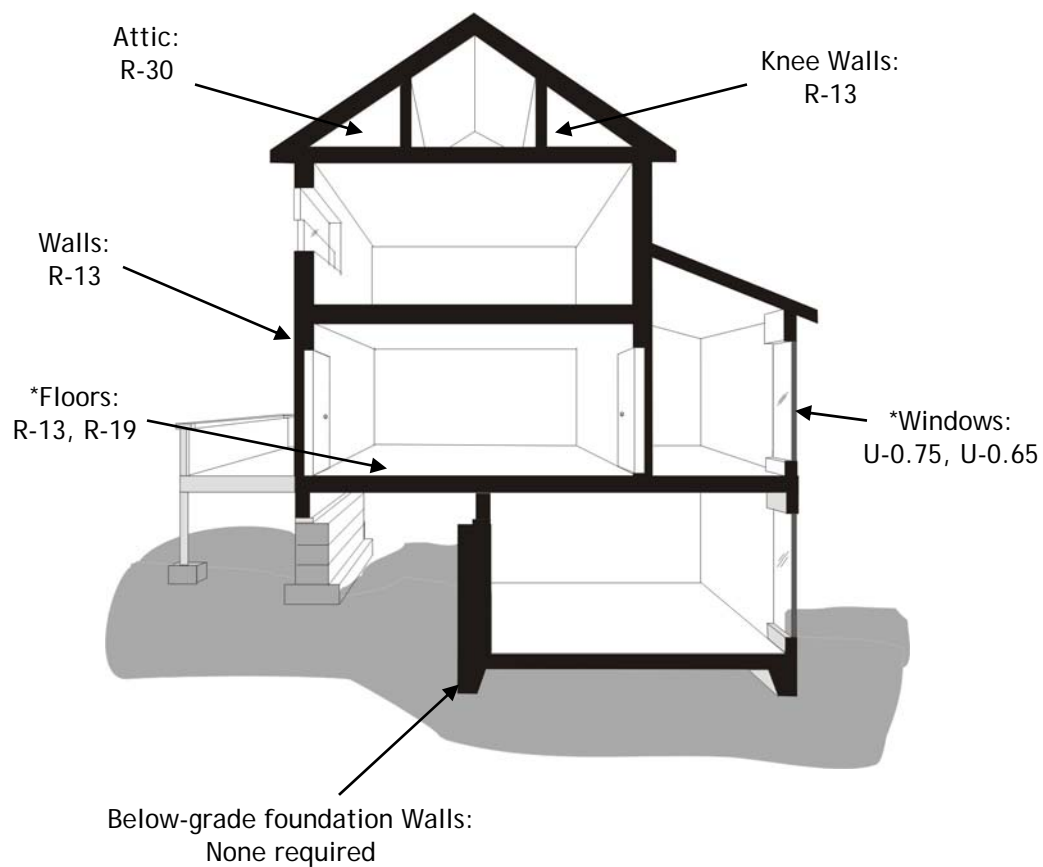

**Where two numbers are listed, first number is for climate zone 2 and the second number is for climate zone 3.*

Insulation Materials

The wide variety of insulation materials makes it difficult to determine which products and techniques are the most cost effective.

Fiberglass insulation products come in batt, roll, and loose-fill form, as well as a high-density board material. Many manufacturers use recycled glass in the production process. Fiberglass is used for insulating virtually every building component – from foundation walls to attics to ductwork.

**Table 5-1
Fiberglass Batt Insulation Characteristics**

Thickness (inches)	R-value	Cost (\$/sq ft)
3 1/2	11	0.28 - 0.35
3 1/2	13	0.34 - 0.37
3 1/2	15	0.64 - 0.67
6 to 6 1/4	19	0.43 - 0.55
8	30	0.64 - 0.91
9 1/2 to 9 3/4	30	0.61 - 0.81
12	38	0.78 - 0.83

This chart is for comparison only. Determine actual thickness, R-value, and cost from manufacturer or local building supply.

- *Cellulose insulation*, made from recycled newsprint, comes primarily in loose-fill form. Cellulose batt insulation has also been introduced in the marketplace. Loose-fill cellulose is used for insulating attics and can be used for walls and floors when installed with a binder, netting, or covering.
- *Rock wool insulation* is mainly available as a loose-fill product and can be installed in attics or blown using damp spray methods into walls. It is fireproof and manufacturers use recycled materials in the production process.
- *Molded-expanded polystyrene*, often known as beadboard, is a foam product made from molded beads of plastic. While it has the lowest R-value per inch of the foam products, it is also the lowest in price. It is used in several alternative building products discussed in this chapter, including insulated concrete forms and structural insulated panels. It performs well in below-grade applications.
- *Extruded polystyrene*, also a foam product, is a homogenous polystyrene product made primarily by three manufacturers with characteristic colors of blue, pink, and green. It is an excellent product for below-grade applications or exterior sheathing.
- *Polyisocyanurate and closed-cell polyurethane* are insulating foams with some of the highest available R-values per inch. Another benefit of these foams is that they provide structural support to the bracing members and sheathing.
- *Open-cell polyurethane* is used primarily to seal air leaks and provide an insulating layer. Polyurethane is one of the only spray foams which can be used in existing buildings, as it will not expand and damage the interior finish.
- *Isocyanate foam*, used primarily to seal air leaks and provide an insulating layer, is foamed with carbon dioxide.
- *Aerated Concrete*, including lightweight, autoclaved (processed at high temperature) concrete can provide a combination of moderate R-values and thermal mass for floors, walls, and ceilings.

Use extra care with all insulation – see the manufacturer’s label for specific product handling information.

**Table 5-2
Comparison of Envelope Insulation Materials
(Environmental Characteristics and Health Impacts)**

Type of Insulation	Installation Method(s)	R-Value per Inch	Raw Materials	Pollution from Production	Indoor Air Quality Impacts	Comments
Fibrous Insulation						
Cellulose	loose fill, wet spray, dense pack, stabilized	3.0 - 3.7	newspaper, borates, ammonium sulfate	Negligible	Fibers and chemicals can be irritants, should be isolated from interior space	High recycled content, very low embodied energy
Fiberglass	batts, loose fill, stabilized, rigid board	3.0 - 4.3	silica, sand, limestone, boron, resin, cullet, some types contain trace amounts of phenol formaldehyde in the binder	Air pollution from energy use	Fibers and chemicals can be irritants, should be isolated from interior space	some loose-fill products have no binder.
Mineral Wool	loose fill (no binder), batts, wet spray	2.3 - 4.0	steel slag or rock, phenol formaldehyde,	Air pollution from energy use	Fibers and chemicals can be irritants, should be isolated from interior space	Sound deadening capacity
Perlite	loose fill	2.5 - 3.3	volcanic rock	Negligible	Some nuisance dust	
Rigid Insulation and Sheathing						
Expanded Polystyrene	rigid boards	3.85 - 5.0	fossil fuels, pentane	Pentane emissions contribute to smog	Concern only for those with chemical sensitivities	Primary non-HCFC foam board
Extruded Polystyrene	rigid boards	3.1 - 5.0	fossil fuels, HCFC-142b	Ozone depletion	Concern only for those with chemical sensitivities	At one time, a recycled product was available
Polyisocyanurate	foil-faced rigid boards	3.6 - 5.6	fossil fuels, HCFC-141b	Ozone depletion	Concern only for those with chemical sensitivities	One non-HCFC-based product is available
Closed-cell Polyurethane	sprayed-in	3.4 - 6.2	fossil fuels, HCFC-141b	Ozone depletion	Concern only for those with chemical sensitivities	
Open-cell Polyurethane	sprayed-in	3.5	fossil fuels, soy oil	Negligible	Unknown, appears to be very safe	Doesn't harden; good air sealing
Fiberboard Sheathing	rigid boards	2.6	sawmill waste, organic by-products, asphalt, wax	Dryer emissions	n/a	

Insulation Strategies

As shown in Table 5-3, fiberglass, rock wool, and cellulose products are the most economical and should serve as bulk insulation in attics, walls, and floors. In attics, loose-fill products are usually less expensive than batts or blankets. Blown cellulose and rock wool are denser than fiberglass, helping reduce air leakage.

Foam Insulation Strategies

Foam products are primarily economical when they can be applied as part of a structural system or to help seal air leaks. Examples include:

- Exterior sheathing over wall framing
- Insulated concrete forms
- As part of a structural insulated panel for walls and roofs
- Spray-applied foam insulation
- Foundation wall or slab insulation – not recommended in Louisiana.

Critical Guidelines

When installing any insulating material, the following guidelines are critical for optimum performance:

- Seal all air leaks between conditioned and unconditioned areas
- Obtain complete, uniform coverage of the insulation
- Minimize air leakage through the material
- Avoid compressing insulation
- Avoid lofting (installing with too much air) in loose-fill products.

Table 5-3
Cost Comparison of Insulating Materials
(Does not including installation)

	Typical R-Value (per inch)*	Typical Cost (\$/sq ft per R-value)*
Batts, blankets and loose-fill insulation		
Mineral wool, fiberglass, rock wool		
Batts or blankets	2.9 - 3.8	.020 - .032
Loose-fill	2.2 - 2.9	.015 - .020
Cellulose (loose-fill)	3.1 - 3.7	.009 - .036
Cotton Insulation	3.0 - 3.7	.048 - .055
Foam insulation and sheathing		
Polyisocyanurate and polyurethane	5.0 - 7.0	.172
Extruded polystyrene	5.0	.075 - .091
Expanded polystyrene	4.0	.063 - .084
Fiberboard sheathing (blackboard)	2.6	.082 - .136
Isocyanate Foam	3.6 - 4.3	n/a
*Determine actual R-values and costs from manufacturers or local suppliers.		

Foundation Insulation

Slab-on-Grade Insulation

Many of Louisiana's homes have slab-on-grade floors for the first story of conditioned space. Slab insulation is not recommended anywhere in the state by the IRC due to problems with termites, which can tunnel undetected through the foam to gain access to the wood framing in the walls. Because of the severity of the problem, this publication does not recommend foam slab insulation in Louisiana.

Foundation Wall Insulation

Foundation walls and other masonry walls are usually built of concrete blocks or poured concrete.

Insulating concrete block cores

Builders can insulate the interior cores of concrete block walls with insulation such as:

- Vermiculite – R-2.1 per inch (see <http://www.epa.gov/asbestos/pubs/verm.html> for more information on vermiculite)
- Polystyrene inserts or beads – R-4.0 to 5.0 per inch
- Polyurethane foam – R-5.8 to 6.8 per inch

Unfortunately, the substantial thermal bridging in the concrete connections between the cores depreciates the overall R-value. Thus, this approach is only a partial solution to providing a quality, well-insulated wall.

Figure 5-2
Insulating Concrete Block Cores
(R-4 to R-6 overall)

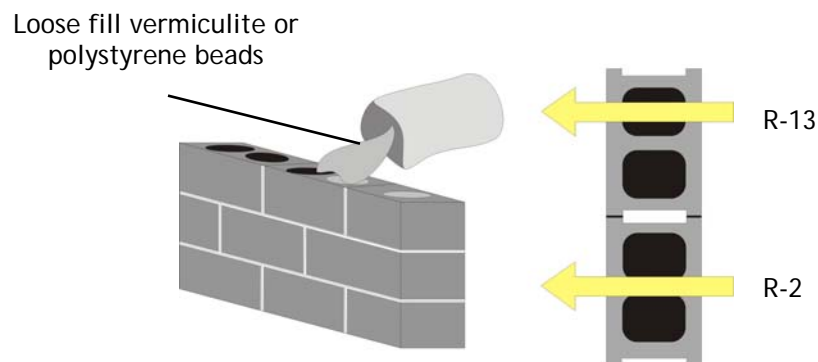

Foundation Vents

The purpose of crawl space vents is to dry out the air under the house. The major source of moisture is the earth floor of the crawl space in most homes. Covering the earth with a layer of polyethylene will eliminate most of the moisture from this source.

In Louisiana, the second greatest source of moisture is air coming in through the vents. Venting crawl spaces which have air conditioning ducts can be of particular concern. Often the ductwork is leaky and poorly insulated, which creates a cold surface that causes water vapor in the air to condense. Air conditioning often cools the floor framing and crawl spaces below the dew point temperature of the outside air. Warm, moist outside air coming through the vents can then condense inside the crawl space as shown in Figure 5-6. In some cases, water accumulating in duct insulation has become heavy enough to pull the entire duct loose.

Because of the poor ability of outdoor air to aid in dehumidifying crawl spaces in summer and a desire to avoid ventilation in winter in order to keep crawl spaces warmer, many building professionals feel that an unvented crawl space is the best option in homes with good exterior drainage systems and no natural gas piping. However, get approval from local code officials before omitting vents.

Figure 5-3
Relative Humidity (RH) and
Foundation Vents

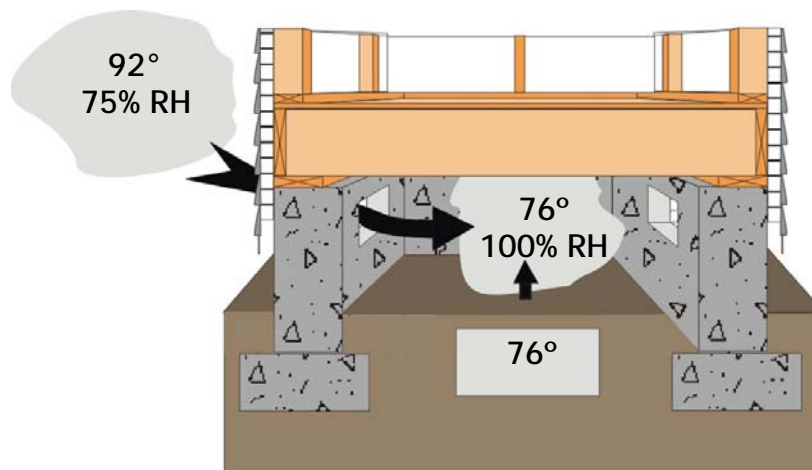

Basement Wall Insulation

Interior Foam Wall Insulation

Foam insulation can be installed on the interior of basement walls; however, it must be covered with a material that resists damage and meets local fire code requirements. Half-inch drywall will typically comply. Furring strips will need to be installed as nailing surfaces. Furring strips are usually installed between sheets of foam insulation. To avoid the direct, uninsulated thermal bridge between the concrete wall and the furring strips, a continuous layer of foam may be installed underneath the nailing strips.

Figure 5-4
Interior Foam Wall Insulation
(R-10 to R-14 overall)

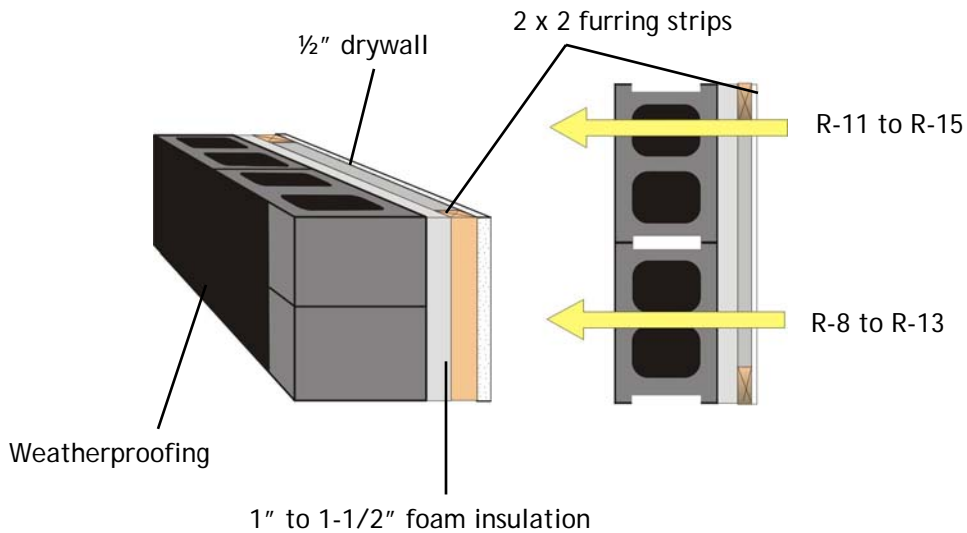

Interior Framed Wall

In some cases, designers will specify a framed wall on the interior of a masonry wall. Standard framed wall insulation and air sealing practice can then be applied.

Figure 5-5
Interior Framed Wall
(R-11 to R-13 overall)

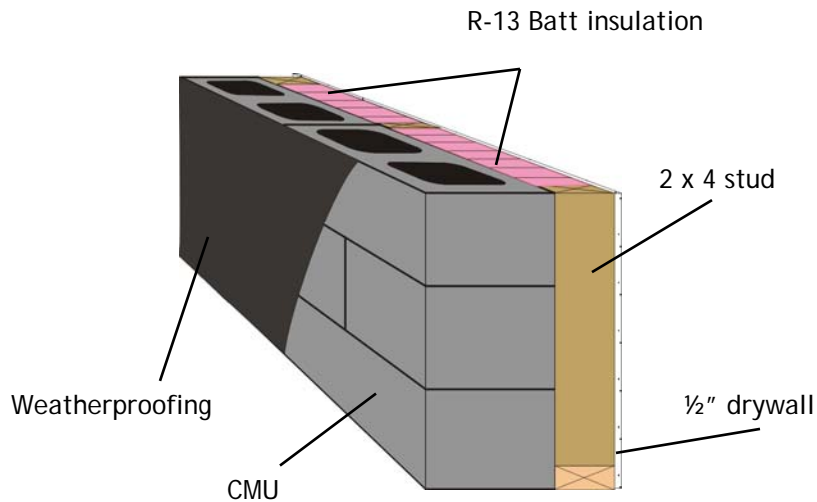

Lightweight Concrete Products

Lightweight, air entrained concrete is an alternative wall system. The aerated concrete, which can be shipped as either blocks or panels, combines elevated R-values (compared to standard concrete) with thermal mass.

Integrated Foam and Concrete Wall Systems

Polystyrene or polyurethane foam can be used as formwork for poured or spray-on structural concrete. Only products containing termiticides should be in direct contact with the ground.

Insulated Concrete Form (ICF) – Several companies manufacture foam blocks that can be installed quickly on the footings of a building. Once stacked, reinforced with rebar, and braced, they can be filled with concrete. ICFs that serve as formwork for concrete basement walls or the entire exterior wall system of the home can save on the cost of materials and reduce heat flow. Advantages include improved termite control due to lack of wood in the exterior structure, durability, hurricane resistance, continuous insulation, and noise control.

Figure 5-6
Insulated Concrete Form Wall Systems
(R-17 to R-24 overall)

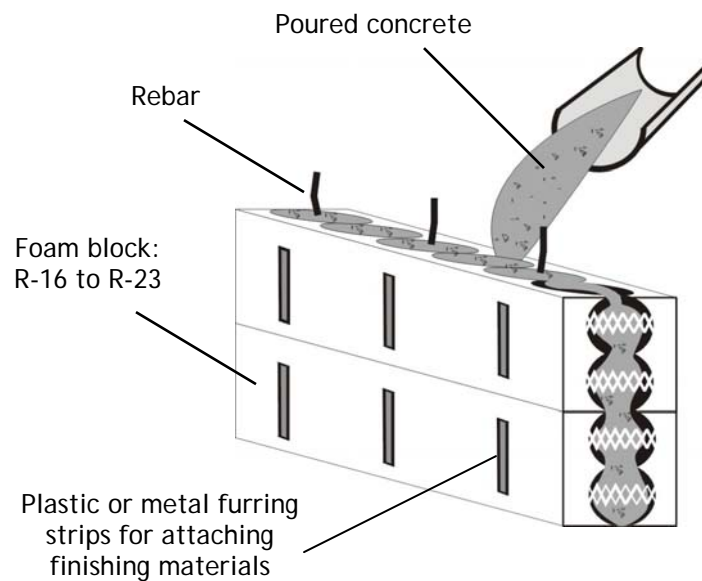

Foam Panel or Snap Tie Systems – Some companies produce systems in which insulation panels are locked together with plastic snap ties. A space, typically eight inches, is created between the foam panels. This space is then filled with concrete. As with foam block systems, installers must follow the manufacturer's recommendations carefully for a successful system. Key considerations are:

- Bracing requirements – the cost of bracing the foam blocks before construction may outweigh any labor savings from the system. Some products require little bracing while others need substantially more.
- Stepped foundations – make sure of the recommendations for stepping foundations – some systems have 12" high blocks or foam sections, while others are 16" high.
- Reinforcing – follow the manufacturer's recommendations for placement of rebar and other reinforcing materials.
- Concrete fill – make sure that the concrete ordered to fill the foam foundation system has the correct slump to meet the manufacturer's requirements. These systems have been subject to blowouts when the installer did not fully comply with the manufacturer's specifications. A blowout is when the foam or its support structure breaks and concrete pours out of the form.

- Termites – follow the guidelines in this chapter concerning termite prevention strategies with any foam product. Homes built completely with ICFs will reduce termite risks because they eliminate framing lumber.

Spray-on Systems – Concrete can be sprayed onto foam panels which are covered by a metal reinforcing grid, part of which is exposed. A structural concrete mixture is sprayed onto the exposed reinforcing metal. As with foam block systems, installers must follow the manufacturer’s recommendations carefully for a successful system.

Note: These systems should not be used below grade to reduce potential for termite infestation.

Framed Floor Insulation

Insulating Under Floors

Many Louisiana homes have floor structures consisting of 2x10 or 2x12 wood joists, wood I-beams, or trusses over unconditioned crawl spaces or basements. Insulation should be installed underneath the subfloor between the framing members. To meet the International Residential Code for floor insulation, R-13 is required in Zone 2 and R-19 in Zone 3.

Most builders use insulation batts with an attached vapor barrier for insulating framed floors. The batts should be installed flush against the subfloor without any gaps, which may serve as a passageway for cold air between the insulation and floor. Special rigid wire supports called “tiger teeth” hold the insulation in place.

**Figure 5-7
Insulated Wood Framed Floors**

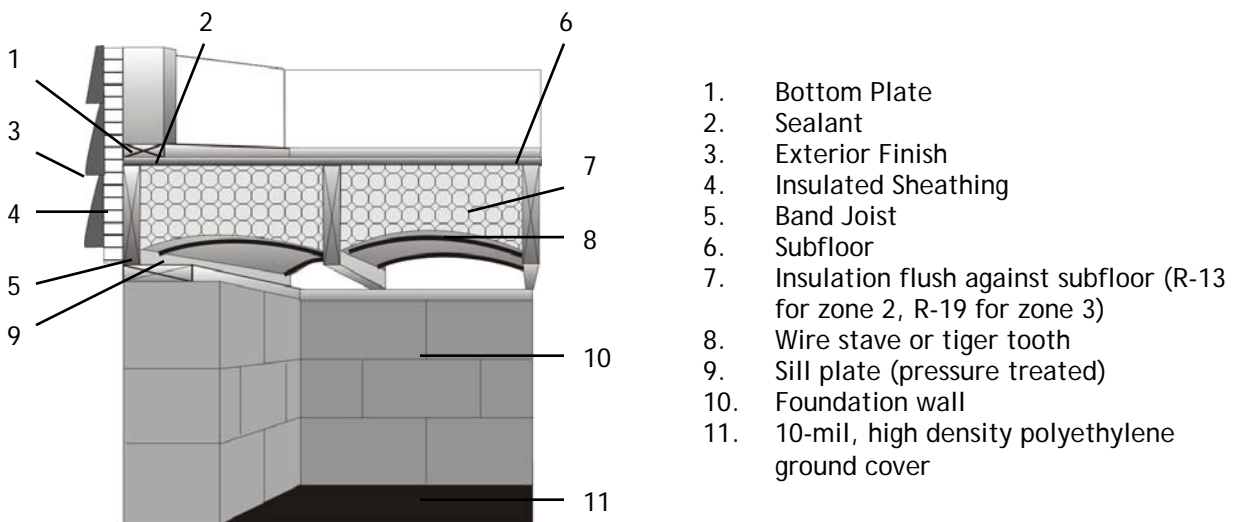

Run wiring, plumbing, and ductwork below the bottom of the insulation so that the continuous layer can be installed. Be certain to insulate all plumbing and ductwork in the unconditioned spaces such as crawl spaces, basements, and attics.

**Figure 5-8
Insulated Floor over Pier Foundation**

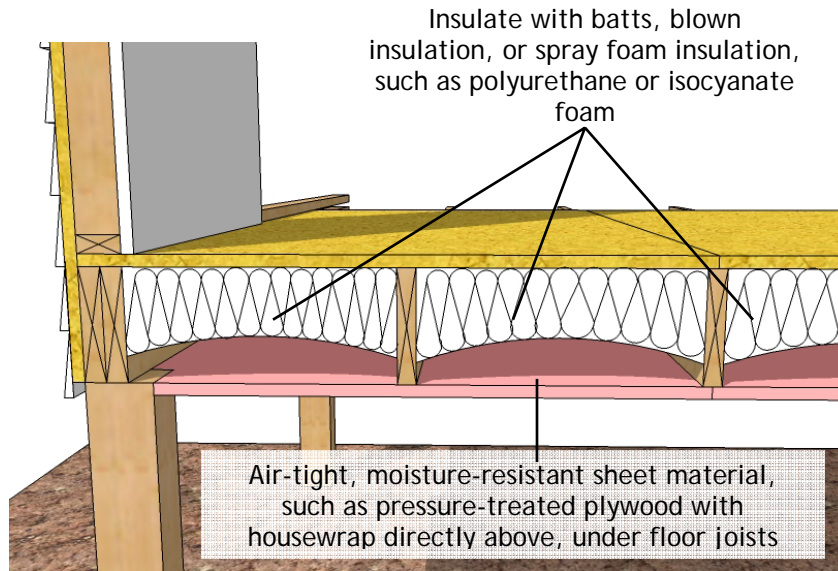

**Table 5-4
Economics of Framed Floor Insulation
Compared to an Uninsulated Floor**

	Energy Savings (\$/yr)	Extra Installed Costs (\$)	Annual Rate of Return	Extra Mortgage Costs (\$/yr)
1. R-11 Batt	363	1030	37.2	83
2. R-13 Batts	380	1110	36.2	89
3. R-19 Batts	431	1380	33.2	111
4. R-30 Batts	474	1820	28.0	147

*For a home with a 2,000 square-foot floor located in Baton Rouge. Analysis assumes 2% annual fuel price escalation; mortgage is 30 year, 7% loan; the energy savings were estimated using REMRate v 12.0 software.

Insulating Crawl Space Walls Rather Than Floors

For years, building professionals have assumed the optimal practice for insulating floors over unheated areas was to insulate underneath the floor. However, studies performed in Tennessee several years ago found that insulating the walls in well-sealed crawl spaces and unconditioned basements can be an effective alternative to under-floor insulation. While the annual heating bills in the homes tested were one to three percent higher than those with under-floor insulation, the cooling bills dropped by approximately the same amount. Because the crawl space remains cool in summer, the home can conduct heat to the crawl space if there is no insulation under the floor.

Figure 5-9
Insulated, Sealed Crawl Space Walls

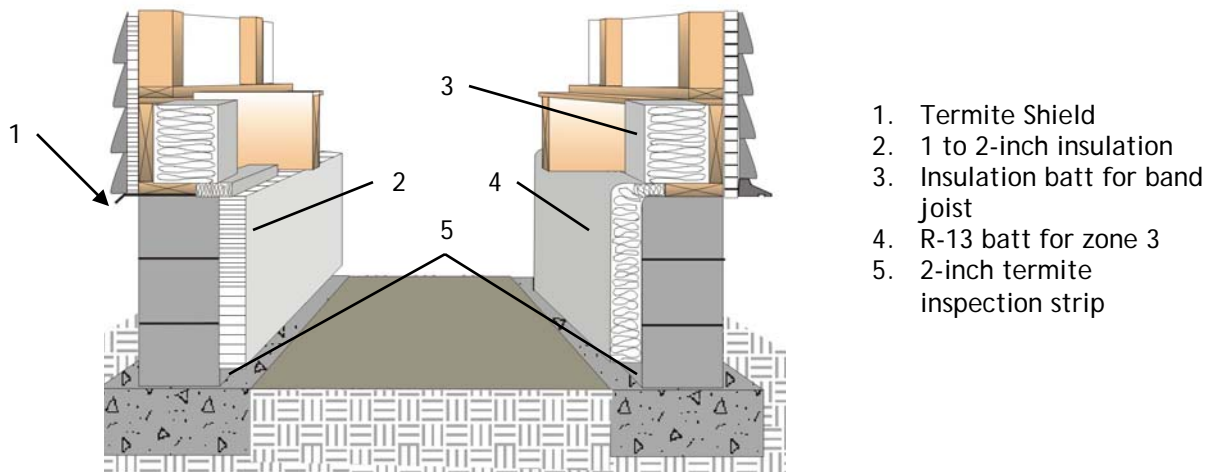

Crawl Space Wall Insulation Requirements:

- Cover the entire earth floor with 6- to 10-mil polyethylene (recommended in all homes)
- A one- or two-inch gap should be left at the bottom of the insulation to serve as a termite inspection strip.
- Insulate the band joist area in addition to the foundation wall.
- The crawl space or basement must have an airtight barrier to the house.
- Review plans for the insulation with local building officials to ensure code compliance

Advantages of Crawl Space Wall Insulation

- Less insulation required (about 800 square feet for a 2000 square-foot crawl space with 4-foot walls).
- Pipe insulation is not required (spaces should stay warmer in winter).

Disadvantages of Crawl Space Wall Insulation

- The insulation may be damaged by rodents and other pests.
- If the crawl space leaks air to the outside, the home will lose considerably more heat than standard homes with under-floor insulation.
- Proper site drainage and a continuous ground cover are essential to keep the crawl space and insulation dry.

Figure 5-10
Floor Insulation Details

• Dots represent critical air sealing locations

Truss - Band Joist Between Floors

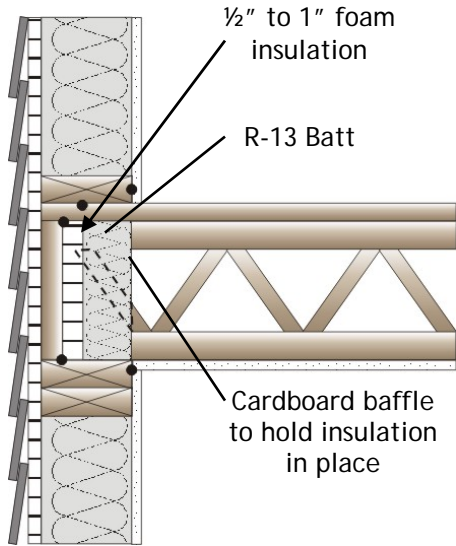

Cantilevered Floor

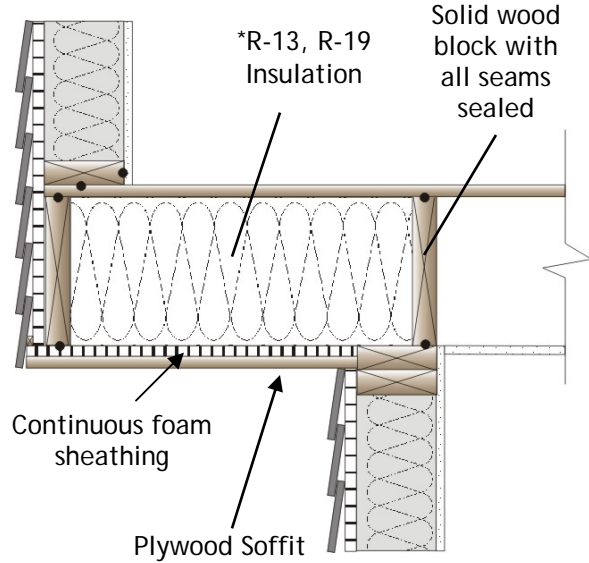

Note: Floor trusses will measure 1" to 3" shorter than total width of exterior wall framing, depending on the exact treatment.

Garage Ceiling Under Bonus Room

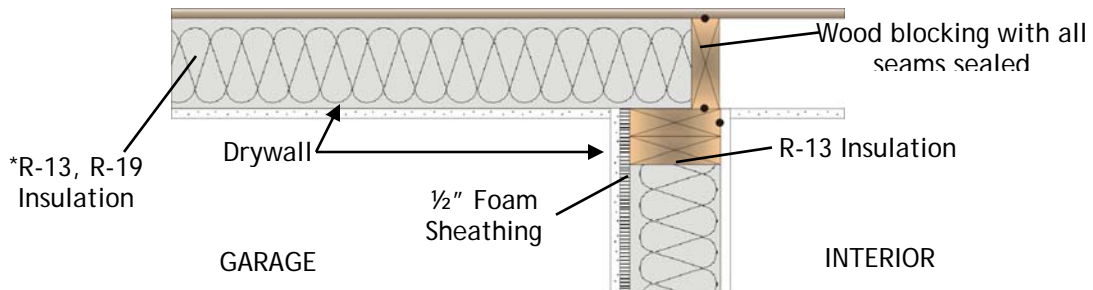

**Where two numbers are listed, first number is for climate zone 2 and the second number is for climate zone 3.*

Wall Construction

Walls are the most complex component of the building envelope to insulate, air seal, and moisture-proof. Throughout the United States, debates continue on optimal wall construction. Issues include:

- Vapor barrier and air sealing systems
- 2 x 4 versus 2 x 6 framing; energy efficient framing
- Which types of wall insulation are best

Wall Framing with Advanced Framing (See Chapter 2)

Advanced framing increases energy efficiency and reduces annual energy costs because of more effective insulation. Several approaches used in advanced framing are shown in Figure 5-12, including:

- Less framing in corners and partition wall intersections
- More efficient headers
- Eliminating curtailed studs (cripples)
- Using single top plates via point loading

2 x 4 Wall Insulation

Table 5-5 summarizes typical problems and solutions in walls framed with 2x4 studs. Solving wall construction problems requires preplanning. In addition to standard framing lumber and fasteners, the following materials will also be required during construction:

- Foam sheathing for insulating headers
- 1x4 let-in bracing or metal T-bracing with 1/2" drywall or other interior for corner bracing
- R-13 or R-19 batts for insulating areas during framing behind shower/tub enclosures or other hidden areas
- 1/2" drywall or other sheet material where needed for air sealing behind enclosures for showers and tubs and other areas that cannot be reached after construction
- Caulking or foam sealant for sealing areas that may be more difficult to seal later

**Figure 5-11
Let-in Bracing**

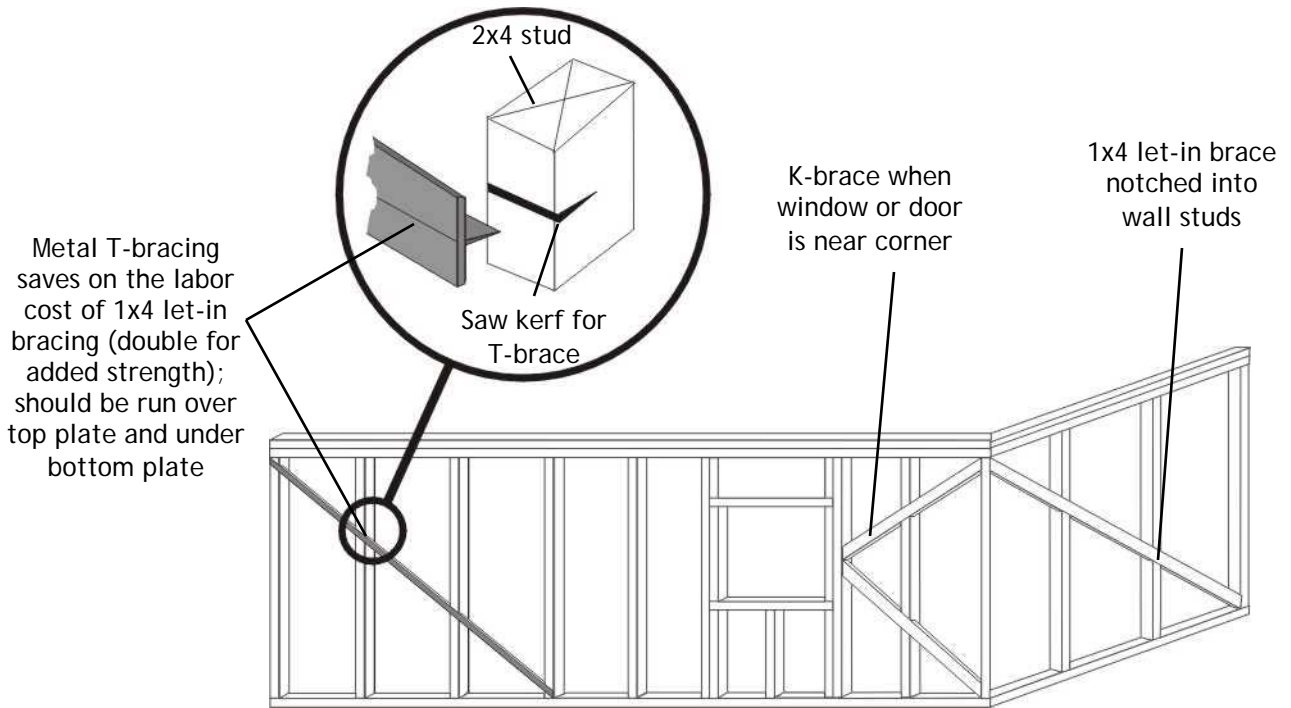
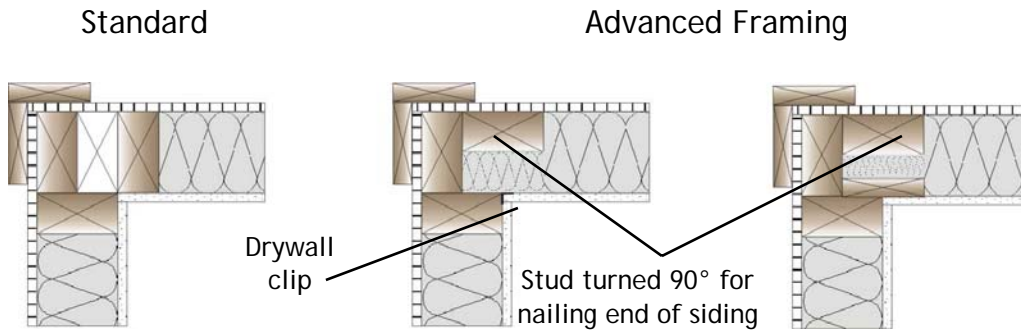

**Table 5-5
2x4 Framed Wall Problems and Solutions**

Problem	Solution
Sometimes there is only a small space available for installation of insulation.	Install continuous exterior foam sheathing and medium (R-13) to high (R-15) density cavity insulation
Enclosed cavities are more prone to cause condensation when sheathing materials with low R-values are used	Install a continuous air barrier system and allow drying to the inside (no interior vapor barrier). Use continuous foam sheathing on the exterior.
Presence of wiring, plumbing, ductwork, and framing members lessens potential R-value and provides pathways for air leakage	Locate piping and ductwork in interior walls; avoid horizontal wiring runs through exterior walls; use air sealing insulation system.

Figure 5-12
Advanced Framing Insulation Details

Corner Framing



Partition Wall Framing

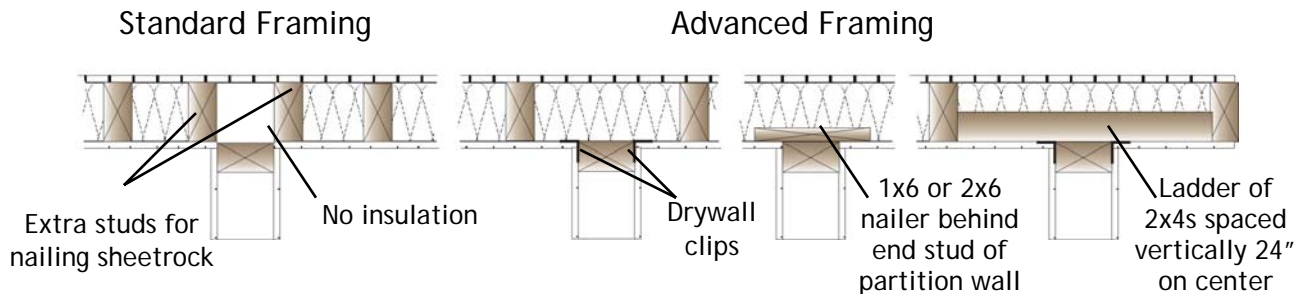

Partition Wall Framing

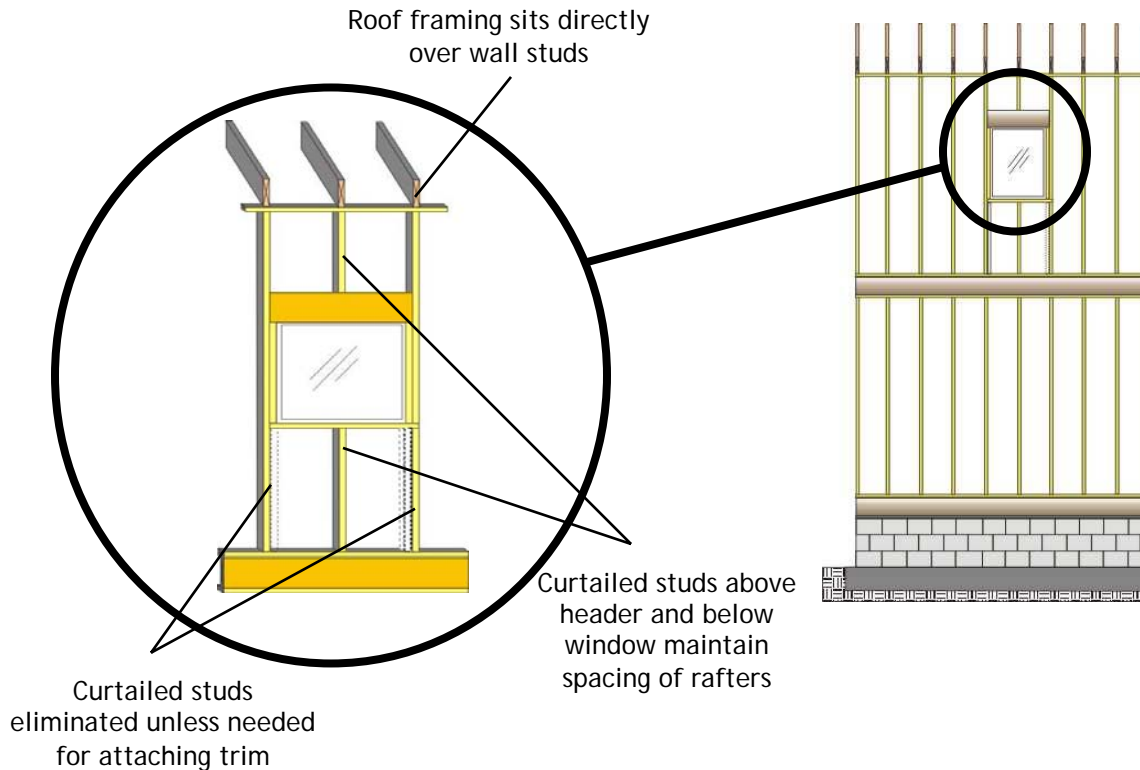
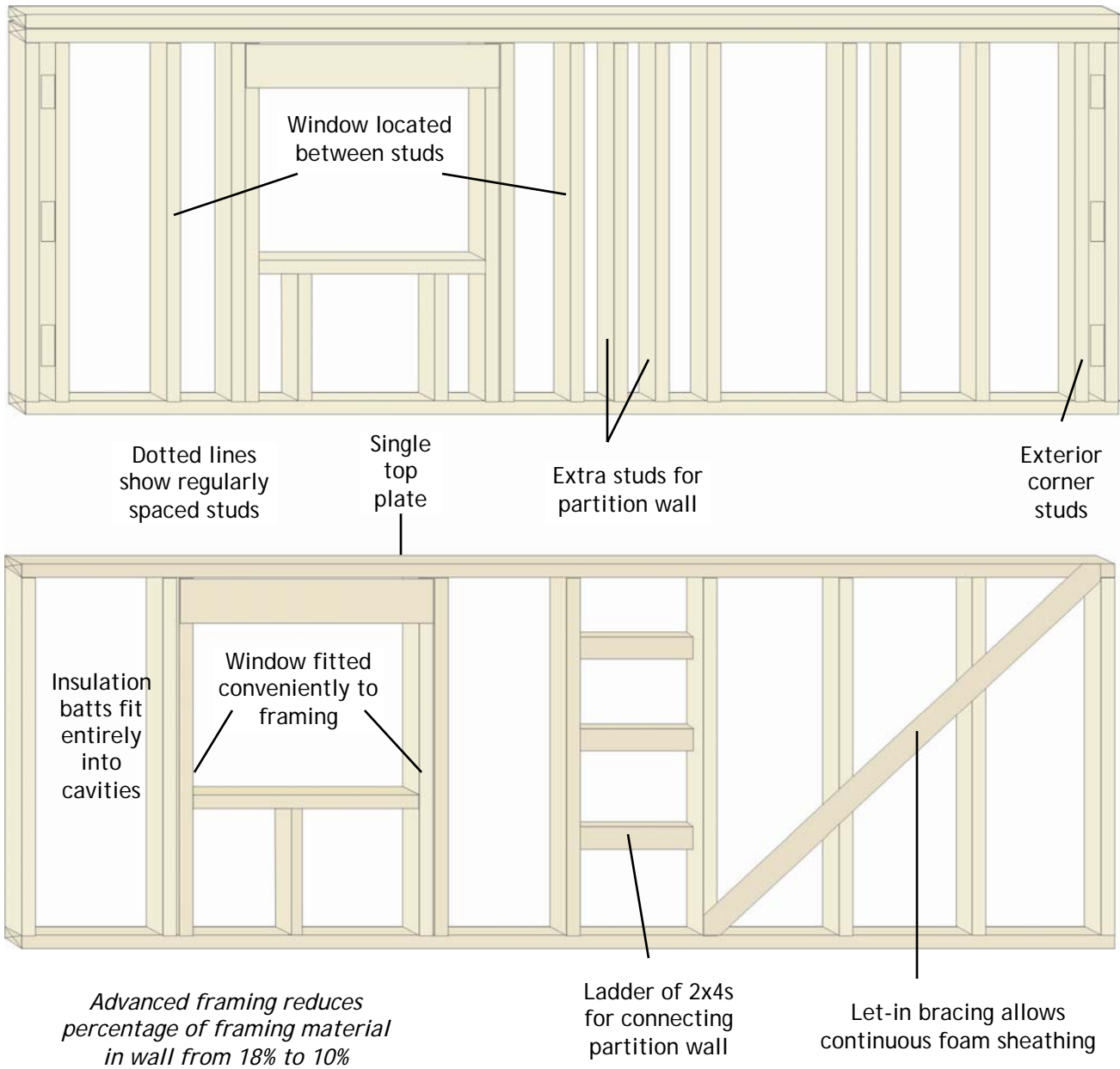

Figure 5-13
Standard Framing versus Advanced Framing
Standard Framing (16" on center)--10 foot wall



Comparison	Standard Framing	Advanced Framing
Insulation Voids	3%	0%
Framing Factor	15 to 25%	10 to 15%
Cavity R-value	R-13	R-13
Sheathing R-value	R-0.5	R-2.5
Average R-value	R-11.1	R-14.6 (30% better)

Batt Insulation - Use Tight-Fitting, Unfaced Batts

Vapor retarder-faced batts were previously considered the standard in Louisiana. However, this prevented wall cavities from being dried by the air conditioning inside the house. In Louisiana's climate, houses need to dry to the inside because the outdoor air is humid much of the time.

Completely fill wall cavities with insulation. Unfaced batts are slightly larger than the standard 16- or 24-inch stud spacing and rely on a friction-fit for support. Since unfaced batts are not stapled, they can often be installed in less time. In addition, it is easier to cut unfaced batts to fit around wiring, plumbing, and other obstructions in the walls.

Figure 5-14
Insulating Walls with Batts

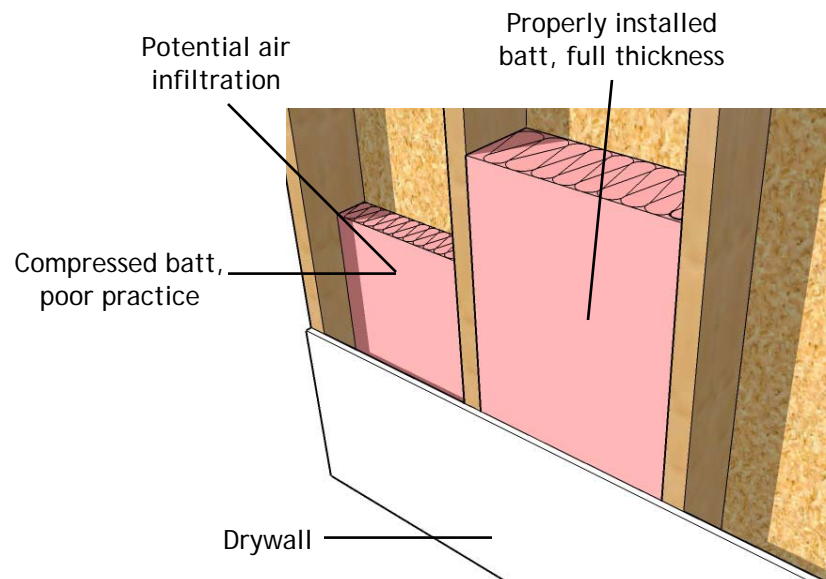

Blown Loose-Fill Insulation

Many contractors select loose-fill cellulose, fiberglass, and rock wool to insulate walls. The insulation is often installed with a blowing machine and held in place with a glue binder or netting. This blown insulation can provide good insulation coverage in the stud cavities; however, you must allow the binder to dry before the wall cavities are enclosed by the interior finish.

Loose-fill materials with high densities, such as cellulose installed at a density of three to four pounds per cubic foot, not only provide good insulation, but also retard air leaks. Fiberglass is less dense than cellulose and does not provide as much resistance to air circulation. Slag or rock wool insulation is denser than either which sound proofs better. All three are similarly priced and provide about the same insulating capability. The additional benefits of air sealing should be considered when evaluating the economics of cellulose or rock wool when installed in a dense-pack fashion.

Figure 5-15
Blown Sidewall Insulation Options

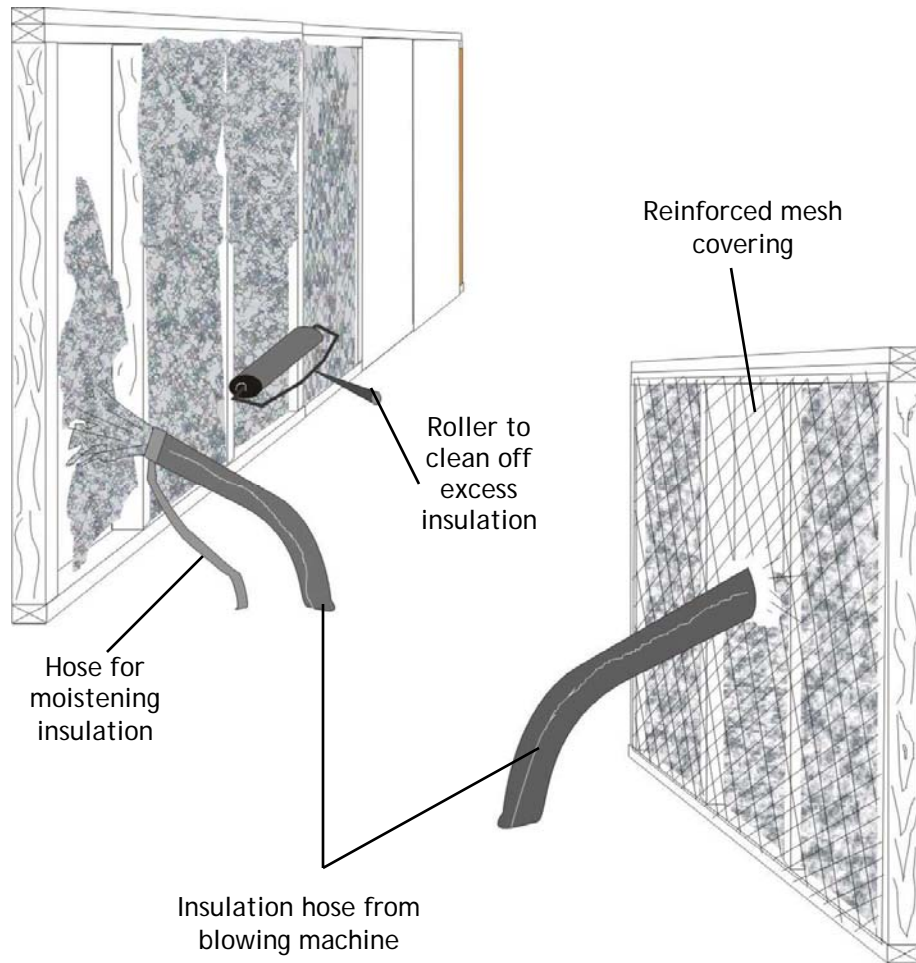

Spray Foam Insulation

Insulation contractors now spray polyurethane or isocyanate foam insulation into walls of new homes. This technique provides high R-values in relatively thin space and seals air leaks effectively. The economics of foam insulation should be examined carefully before deciding on its use.

Figure 5-16
Spray Foam Insulation

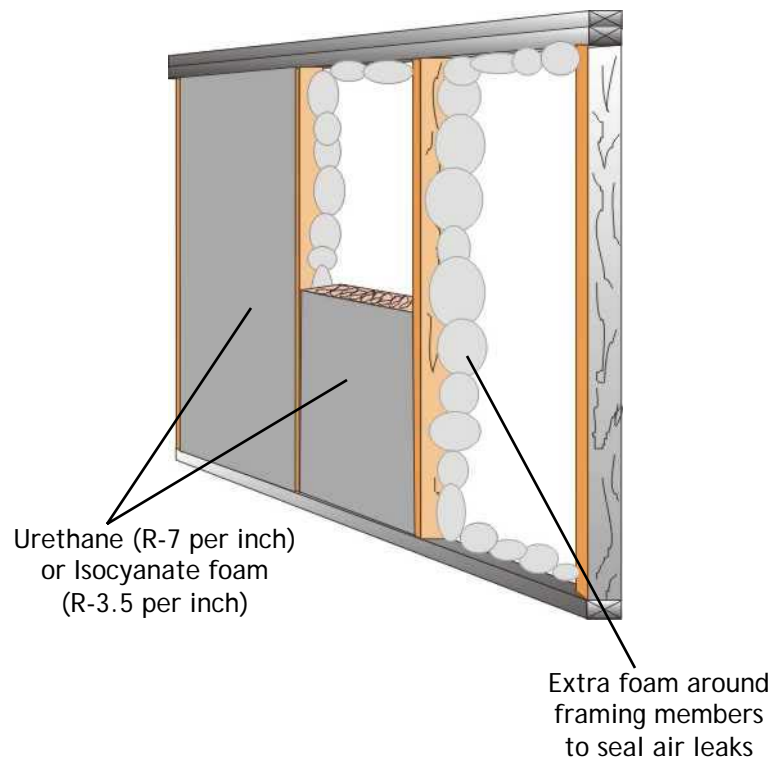

Structural Insulated Panels

Another approach to wall construction is the use of structural insulated panels (SIPs), also known as stress-skin panels. They consist of 3.5- or 5.5-inch thick foam panels onto which sheets of structural plywood or oriented strand board (OSB) have been glued. They reduce labor costs and, because of the reduced framing in the wall, have higher R-values and less air leakage than standard walls.

SIPs come in a variety of sizes up to whole walls. There are a number of manufacturers, each with its own method of attaching panels together. Procedures for installing windows, doors, wiring, and plumbing have been worked out by each manufacturer. In addition to their use as wall framing, SIPs can also form the structural roof of a building.

Figure 5-17
Structural Insulated Panels (SIP)

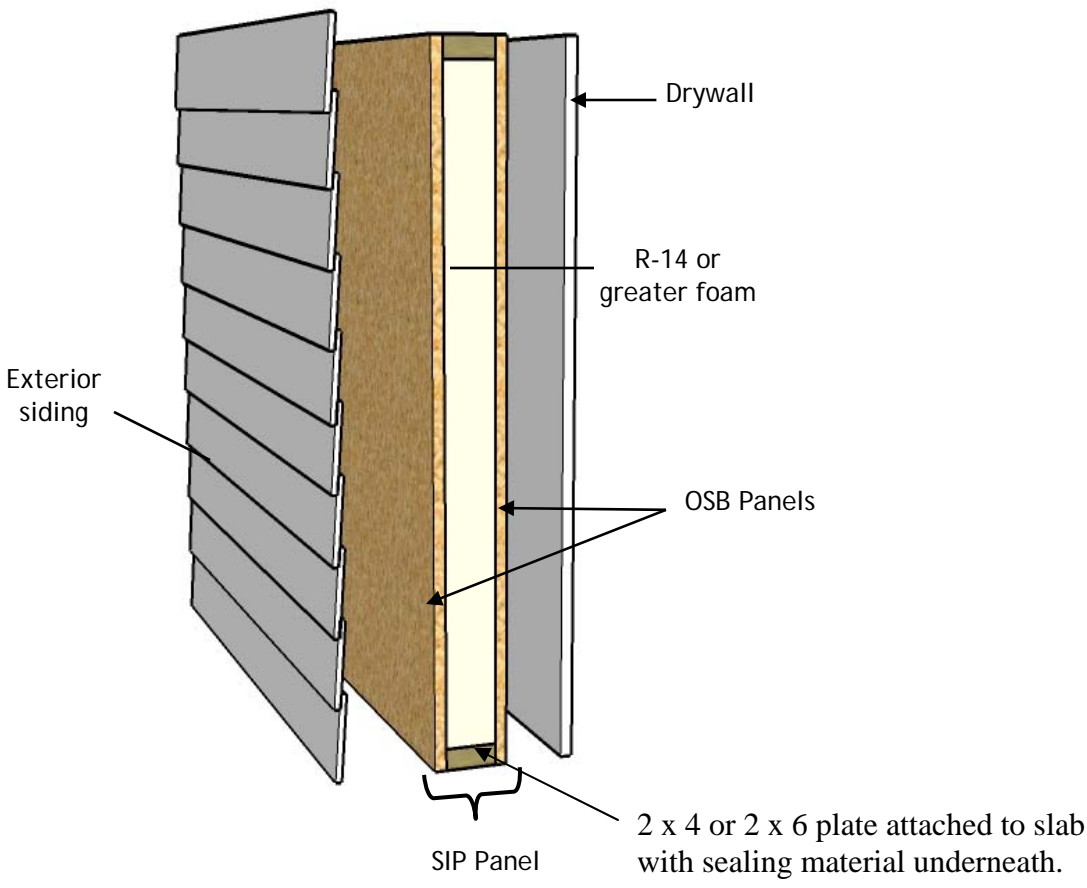

Homes built with SIPs are generally more expensive than those with standard framing and insulation. However, research has shown that they have higher average insulating values and less air leakage.

Figure 5-18
Structural Insulated Panels Construction

1

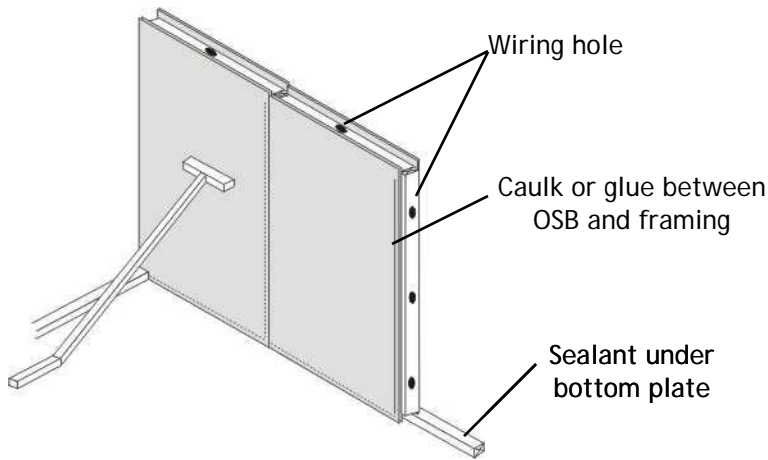

- Install first panel on top of bottom plate - caulk in place
- Be careful to install panel plumb and level

2

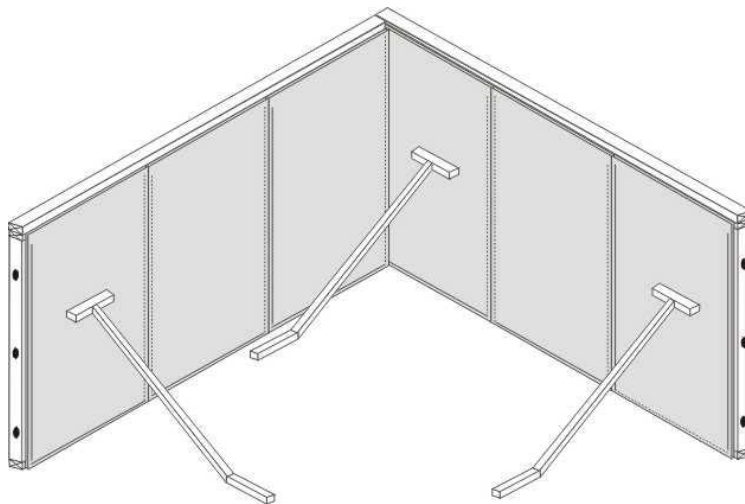

- Continue installing panels, caulking all seams and checking for plumb and level
- Install continuous top plate

3

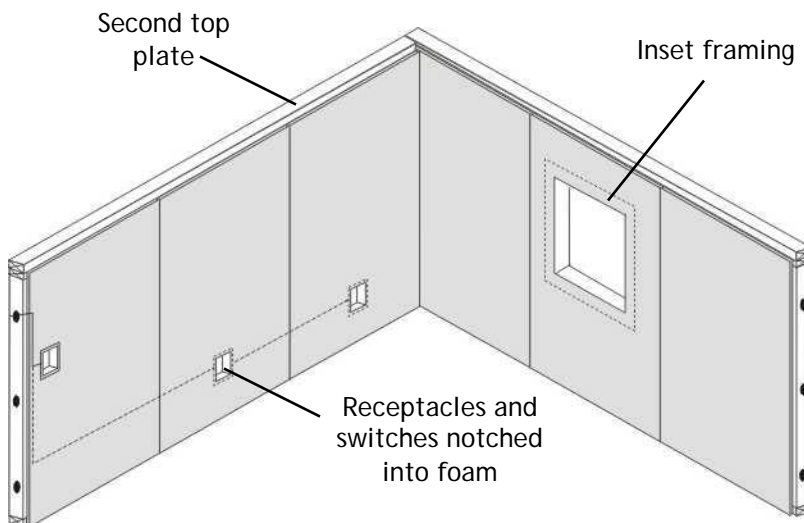

- Install second top plate
- Run wiring
- Cut holes for windows, if necessary
- Notch into foam using a special tool to inset framing around rough openings
- Install caulk and framing

Metal Framing

Builders and designers are well aware of the increasing cost and decreasing quality of framing lumber. As a consequence, interest in alternative framing materials, such as metal framing, has grown. While metal framing offers advantages over wood, such as consistency of dimensions, lack of warping, and resistance to moisture and insect problems, it has distinct disadvantages from an energy perspective.

Metal framing serves as an excellent conductor of heat. Homes framed with metal studs and plates usually have metal ceiling joists and rafters as well. Thus, the entire structure serves as a highly conductive thermal grid. Insulation placed between metal studs and joists is much less effective due to the extreme thermal bridging that occurs across the framing members.

There have been moisture-related problems in metal frame buildings in Louisiana that do not use insulated sheathing on exterior walls. Metal studs cooled by the air conditioning system can cause moisture in outdoor air to condense on the exterior sheathing and cause mildew streaks. Similar problems can also occur on interior walls in winter.

The American Iron and Steel Institute is well aware of the challenges involved in building an energy efficient steel structure. In their publication *Thermal Design Guide for Exterior Walls* (Publication RG-9405), the Institute provides information on the thermal performance of steel-framed homes. Table 5-6 shows options for meeting the requirements of the IRC in steel framed walls, as well as the impact of metal framing on the effective insulating value of walls. Even in walls with insulating foam sheathing, R-values drop 18% to 27% when substituting metal framing for wood.

**Table 5-6
Steel Wall Insulation Options**

	Cavity R-Value	Sheathing R-Value	Effective R- Value**
Option 1	13	5	11.5
Option 2	15	4	10.4
Option 3	21 *	3	10.4
*2x6 studs, 16" on center **Does not include sheathing			

Researchers have delved into numerous ways to provide for a thermal break in walls with steel framing. The most effective solution has been to increase the insulating value of the sheathing. However, the home still suffers considerable conduction losses up to the attic if the ceiling joists and rafters are steel-framed. The best solution to the heat gain through steel framing in attics is to install a thermal break, such as a sill sealer material between wall framing and ceiling joists. Then, install a layer of foam sheathing underneath the ceiling joists before installing drywall.

Wall Sheathings

Many Louisiana builders use 1/2-inch wood sheathing (R-0.6) or asphalt-impregnated sheathing, usually called blackboard (R-1.3), to cover the exterior walls of a building before installing the siding. A better method thermally is to use 1/2-inch expanded polystyrene (R-2), extruded polystyrene (R-2.5 to 3), polyisocyanurate or polyurethane (R-3.4 to 3.6) foam insulated sheathing with diagonal braces. Check with local building code officials before using this method.

Figure 5-19
Foam Sheathing Keeps Walls Warmer

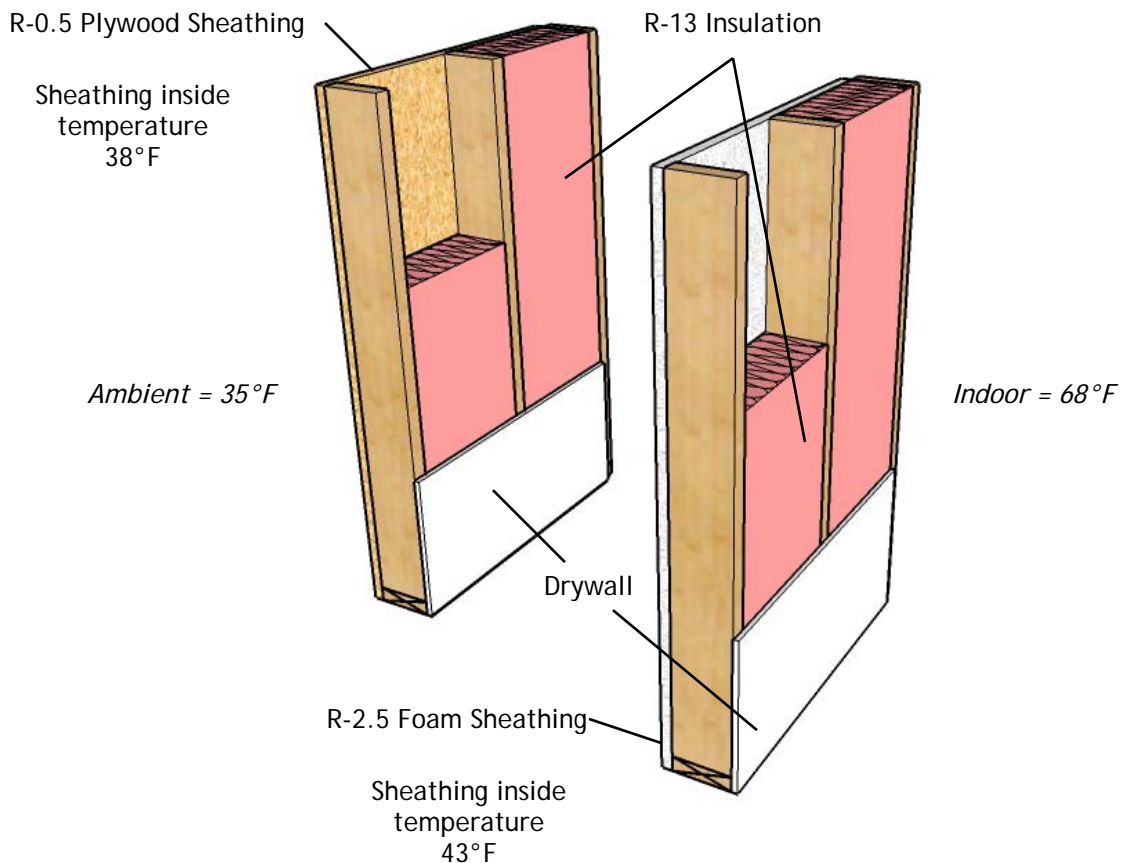

Advantages of foam sheathing over wood or blackboard include:

- Saves energy
- Easier to cut and install
- Protects against condensation (Figure 5-19)
- Less expensive than plywood

The recommended thickness of the sheathing is based on the desired R-value and the jamb design for windows and doors – usually 1/2-inch. Be certain that the sheathing completely covers the top plate and any band joist at the floor. Most manufacturers offer sheathing products in 9- or 10-foot lengths to allow complete coverage of the wall. Once it is installed, patch all holes.

**Table 5-7
Sheathing Costs***

Sheathing	Cost (\$)	R-value
1/2" asphalt impregnated fiberboard	349	1.3
1/2" beadboard (MEPS)	349	2.0
1/2" oriented strand board (OSB)	369	0.60
1/2" extruded polystyrene	480	2.5
1/2" polyisocyanurate	480	3.5 - 3.7

* For a 2,000 square-foot home using 64 sheets of 4 x 8 material.

2x6 Wall Construction

There has been some interest in northern Louisiana about the use of 2x6 lumber for construction. The International Residential Code 2006 allows 2x6s to be spaced on 24-inch centers, rather than the 16-inch centers required for 2x4s. This permits the use of R-19 or 21 insulation in the cavities.

The Advantages of Using Wider Wall Framing Are:

- More space provides room for R-19 or R-21 wall cavity insulation.
- Thermal bridging across studs is less of a penalty due to the higher R-value of 2x6s.
- Fewer instances of thermal bridging occur in the wall.
- There is more space for insulating around piping, wiring, and ductwork.

Disadvantages of 2x6 Framing Include:

- Wider spacing may not support the interior or exterior finishes adequately, allowing them to bow slightly between studs.
- Window and door jambs are wider and can add \$12 to \$15 per opening for jamb extenders.
- Walls with large window and door areas may require almost as much framing as 2x4 walls, leaving less space for insulation.

The economics of 2x6 wall insulation depends on the number of windows in the wall, since each window opening adds extra studs and requires the purchase of a jamb extender. Figure 5-20 compares 2x4 and 2x6 framing. Walls built with 2x6s having few windows may provide a positive economic payback in northern Louisiana. However, in walls where windows make up over 7.5% of the total area, the economics become questionable because of the cost of jamb extenders and the minor improvement in average wall R-value.

Figure 5-20
Average Wall R-Value

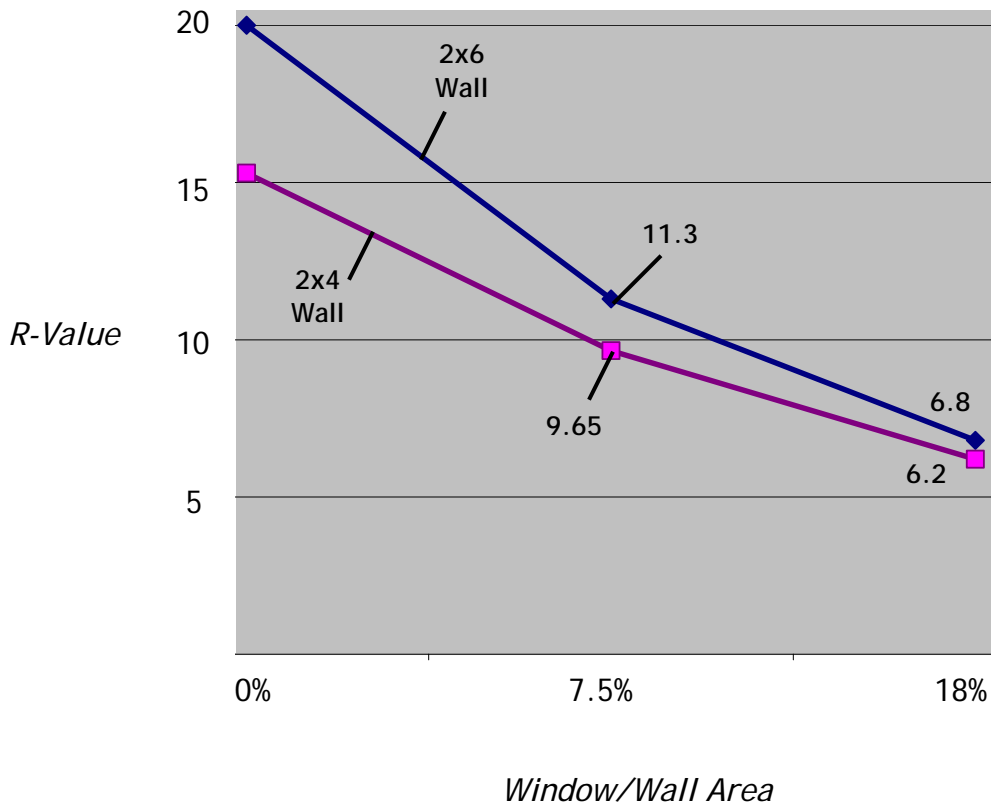

Table 5-8
Economics of Wall Insulation*
(Compared to pre-code “Business as Usual” R-11 Batts with fair installation)

	Energy Savings (\$/yr)	Extra Installed Costs (\$)	Annual Rate of Return	Extra Mortgage Costs (\$/yr)
2 x 4 Wall				
R-13 Batts	22	64	36.4%	5
R-15 Batts	38	544	7.6%	44
R-14 Cellulose Insulation (reduced air leakage)	95	534	19.7%	43
R-13 Batts, R-2.5 continuous sheathing	38	424	10.0%	34
2 x 6 Wall				
R-19 Batts	94	736	14.4%	59
R-19 Batts, R-5 continuous sheathing	136	1096	14.0%	88

*For a home with a 2,000 square-foot floor located in Baton Rouge. Analysis assumes 2% annual fuel price escalation; mortgage is 30-year, 7% loan; the energy savings were estimated using REMRate v. 12.0 software.

Ceilings and Roofs

Attics over flat ceilings are usually the easiest part of a home's exterior envelope to insulate. They are accessible and have ample room for insulation. However, many homes have cathedral ceilings that provide little space for insulation. It is important to insulate both types of ceilings properly.

Attic Ventilation

In summer, ventilation reduces roof and ceiling temperatures, thus saving on cooling costs and lengthening the roof's life. In winter, properly designed roof vents expel moisture which could otherwise accumulate and deteriorate insulation or other building materials.

Is Ventilation Necessary?

At present, building science experts are questioning whether attic ventilation is beneficial. For years, researchers have believed the cooling benefits of ventilating a well insulated attic are negligible. However, some experts are now questioning whether ventilation is even effective at moisture removal. Until the results of current research have been accepted, builders should follow local code requirements.

Unvented Attics

Unventilated attics can provide durable, energy efficient structures if using structural insulated panels or aerated concrete panels as the roofing system of the structure. Some builders have opted to pack the rafter space in cathedral ceilings completely with high density insulation, such as cellulose or rock wool and eliminate attic ventilation. However, this approach will avoid moisture problems only with careful installations and detailing.

Vent Selection

If ventilating the roof, locate vents high along the roof ridge and low along the eave or soffit. Vents should provide air movement across the entire roof area. There are a wide variety of products available including ridge, gable, soffit, mushroom, and turbine vents.

The combination of continuous ridge vents along the peak of the roof and continuous soffit vents at the eave provides the most effective ventilation. Ridge vents come in a variety of colors to match any roof. Some brands are made of corrugated plastic that can be covered by cap shingles to hide the vent from view.

Figure 5-21
Ridge and Soffit Vents

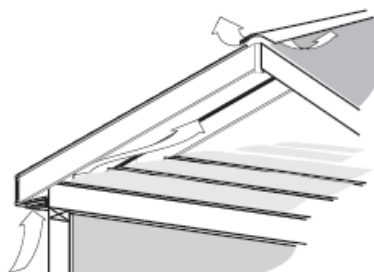

Guidelines for Attic/Roof Ventilation

The amount of attic ventilation needed is determined by the size of the attic floor and the amount of moisture entering the attic. General guidelines are:

- 1 square foot of attic vent for each 150 square feet of attic floor area without a ceiling vapor barrier, such as the backing on batt insulation.
- The total vent area should be divided equally between high and low vents; thus, if 10 total square feet of vent are needed, locate 5 square feet at the ridge and another 5 square feet at the soffit.
- Only the net free area is effective – about 70% of the total vent area (discounts the louvers and flange of the vents).

Powered Attic Ventilator Problems

Electrically powered roof ventilators can consume more electricity to operate than they save on air conditioning costs and are not recommended for most designs. NEVER use a powered ventilator with a sealed attic! Power vents can create negative pressures in the home, which may have detrimental effects such as:

- Drawing air from the crawl space into the home
- Removing conditioned air from the home through ceiling leaks and bypasses
- Pulling pollutants such as pesticides and sewer gases into the home
- Backdrafting fireplaces and fuel-burning appliances

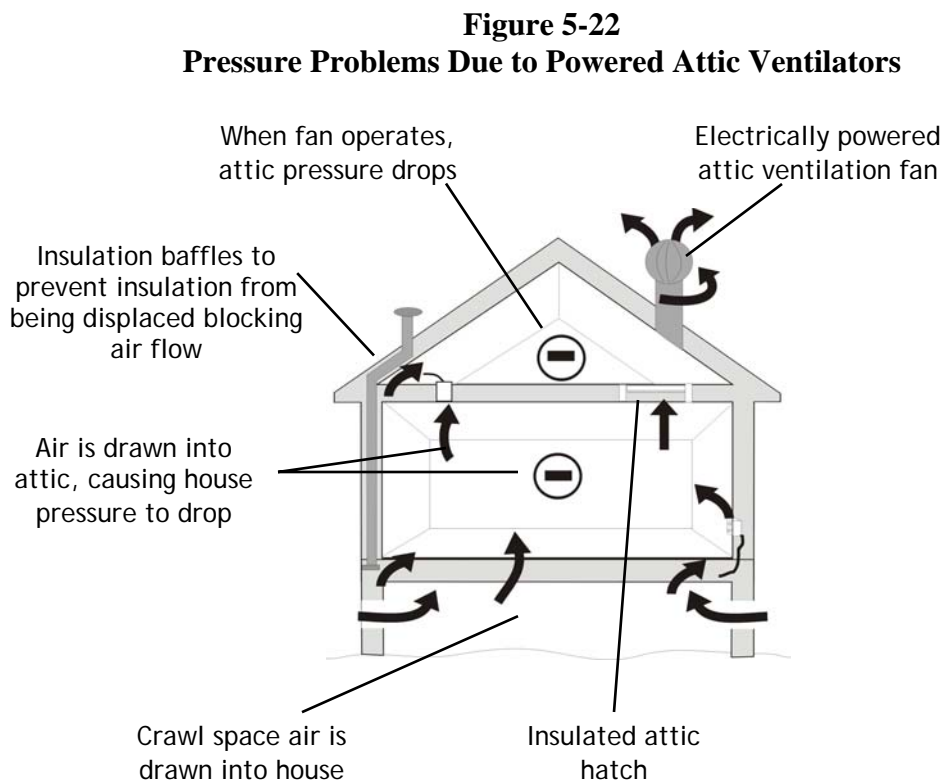

Attic Floor Insulation Techniques

Either loose-fill or batt insulation can be installed on an attic floor. Unfaced batts should be installed. As shown in Table 5-9, blowing loose-fill attic insulation – fiberglass, rock wool or cellulose – is usually less expensive than installing batts or rolls. Batts are less likely to be moved by high air flows from storms in a vented attic, but baffles are available to keep loose-fill insulation in place.

Table 5-9
Typical Attic Insulation Costs (\$/sq ft)

R-30 Batt Insulation	1.30
R-25 Blown Insulation	0.79
R-30 Blown Insulation	0.89
R-38 Blown Insulation	0.98

Steps For Installing Loose-Fill Attic Insulation:

1. Seal attic air leaks, as prescribed by fire and energy codes.
2. Follow manufacturer’s clearance requirements for heat-producing equipment found in an attic, such as flues or exhaust fans. Other blocking requirements may be mandated by local building codes. Use metal flashing, plastic or cardboard baffles, or pieces of batt insulation for blocking. Attic blocking requirements are shown in Figure 5-23 on the previous page.
3. Use cardboard baffles, insulation batts, or other baffle materials to preserve ventilation from soffit vents at eave of roof.
4. Insulate the attic hatch or attic stair. There are foam boxes for providing a degree of insulation over a pull-down attic stairway.
5. Determine the attic insulation area. Based on the spacing and size of the joists, use the chart on the insulation bag to determine the number of bags to install. Table 5-10 shows a sample chart for cellulose insulation.
6. Avoid fluffing the insulation (blowing with too much air) by using the proper air-to-insulation mixture in the blowing machine. A few insulation contractors have “fluffed” loose-fill insulation to give the impression of a high R-value. The insulation may be the proper depth, but if too few bags are installed, the R-values will be less than claimed.
7. Obtain complete coverage of the blown insulation at similar insulation depths. Use attic rulers to ensure uniform depth of insulation. This is an IRC 2006 requirement – see details there.

Table 5-10
Typical Blowing Chart for Loose-Fill Insulation (Cellulose Insulation Example)

R-value at 75° F	Minimum Thickness (in)	Minimum Weight (lb/sq ft)	2x6 Joists Spaced 24 Inches on Center		2x6 Joists Spaced 16 Inches on Center	
			Coverage per 25-lb bag (sq ft)	Bags per 1,000 sq ft	Coverage per 25-lb bag (sq ft)	Bags per 1,000 sq ft
R-40	10.8	2.10	12	83	13	77
R-30	8.1	1.45	17	59	19	53
R-24	6.5	0.98	21	48	23	43
R-19	5.1	0.67	37	27	41	24

**Figure 5-23
Attic Blocking Requirements**

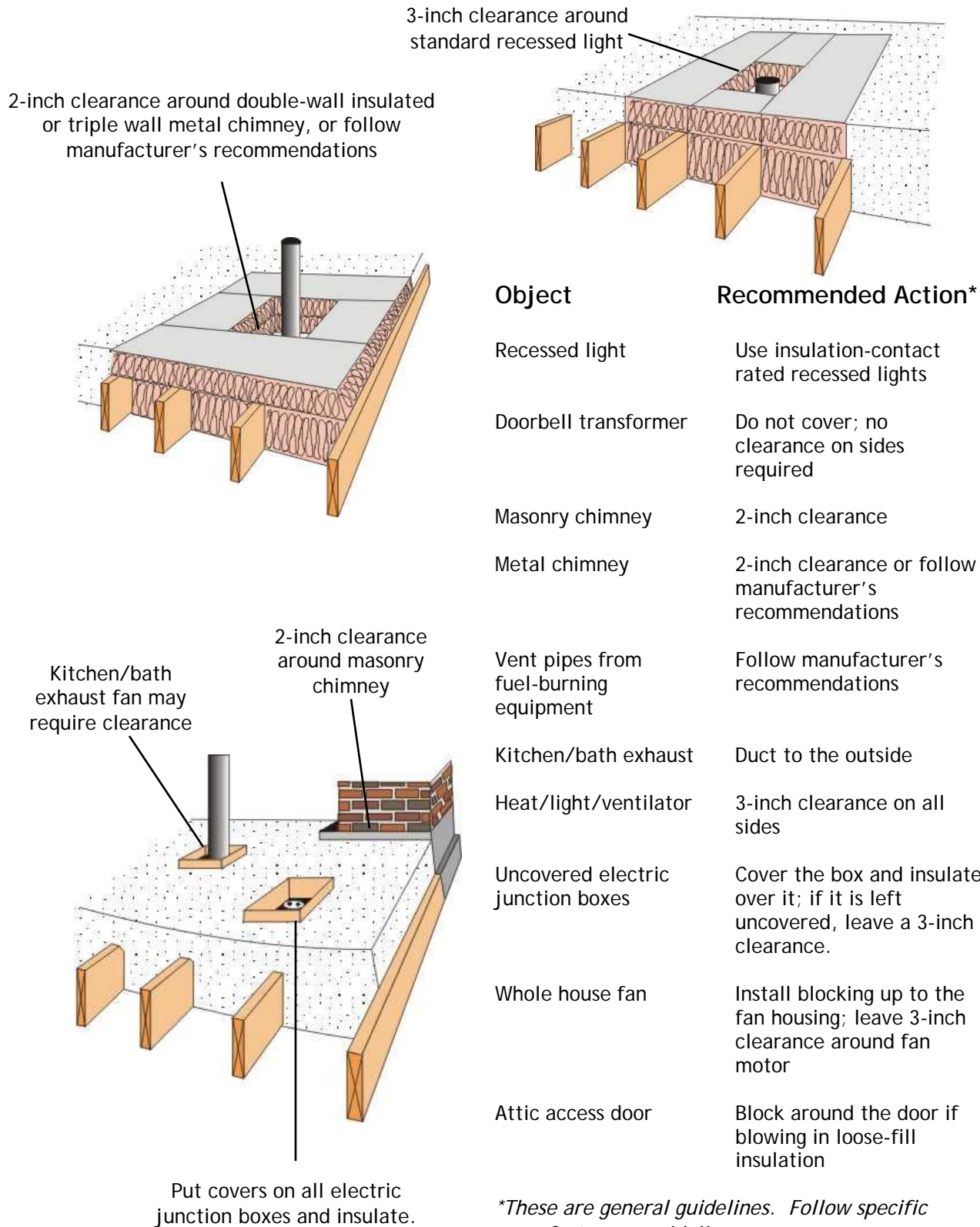

Steps for Installing Batt Insulation

1. Seal attic air leaks, as prescribed by fire and energy codes.
2. Block around heat-producing devices, as described in Step 2 for loose-fill insulation.
3. Insulate the attic hatch or attic stair as described in Step 4 for loose-fill insulation.
4. Determine the attic insulation area based on the spacing and size of the joists; order sufficient R-30 insulation for the flat attic floor. Choose batts that are tapered cut – wider on the top – so that they cover the top of the ceiling joists. (Figure 5-24)
5. When installing the batts, make certain they completely fill the joist cavities. Shake batts to ensure proper loft. If the joist spacing is uneven, patch gaps in the insulation with scrap pieces. Try not to compress the insulation with wiring, plumbing, or ductwork. In general, obtain complete coverage of full-thickness, non-compressed insulation.
6. Attic storage areas can pose a problem. If the ceiling joists are shallower than the depth of the insulation (generally less than 2x10s), raise the finished floor using 2x4s or other spacing lumber. Install the batts before nailing the storage floor in place. (Figure 5-25)

Figure 5-24
Full Width Batts

Batts are cut wider on top to cover tops of ceiling joists

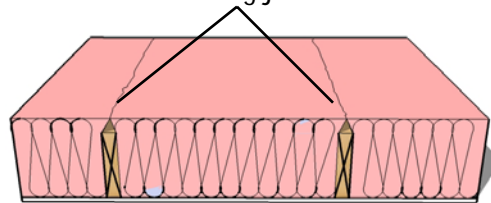
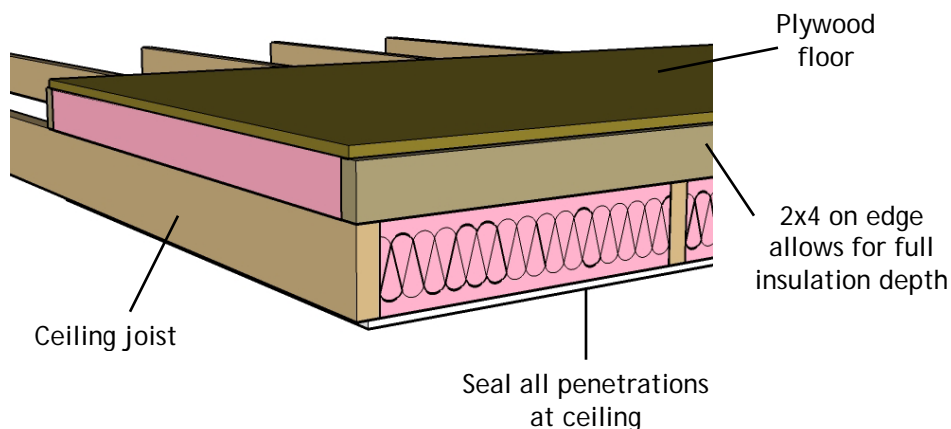

Figure 5-25
Insulating under Attic Floors



Increasing the Roof Height at the Eave

One problem area in many standard roof designs is at the eave, where there is often insufficient space for full insulation without blocking air flow from the soffit vents. If the insulation is compressed, its R-value will decline. Figure 5-26 shows several solutions to this problem. If using a

truss roof, purchase raised heel trusses that form horizontal overhangs. They should provide clearance for both ventilation and insulation.

In stick-built roofs, where rafters and ceiling joists are cut and installed at the construction site, an additional top plate that lays across the top of the ceiling joists at the eave will prevent compression of the attic insulation. The rafters sitting on this raised top plate allow for both insulation and ventilation.

The raised top plate design also minimizes windwashing of the attic insulation, where air entering the soffit vents flows through the attic insulation. Place a band joist over the open joist cavities of the roof framing. The band joists help prevent windwashing, which can reduce attic insulation R-values on extremely cold days and can add moisture to the insulation. Another method of preventing windwashing is to use preformed cardboard or foam forms which fit snugly between rafters and are designed for this purpose.

Raised top plates also elevate the overhang of the home, which may enhance the building's attractiveness. The aesthetic advantage is especially useful in one-story homes with standard 8-foot ceilings. However, raised top plates can reduce shading on exposed windows.

Table 5-11
Economics of Attic Insulation*
Compared to R-19 Blown Insulation

	Energy Savings (\$/yr)	Extra Installed Costs (\$)	Annual Rate of Return	Extra Mortgage Costs (\$/yr)
R-25 Blown Insulation	38	210	20.0%	17
R-30 Blown Insulation	59	385	17.1%	31
R-38 Blown Insulation	81	665	13.7%	54
R-50 Blown Insulation	102	1085	10.6%	87

*For a home with a 2,000 square-foot attic located in Baton Rouge. Analysis assumes 2% annual fuel price escalation; mortgage is 30-year, 7% loan; the energy savings were estimated using REMRate v. 12.0 software.

Figure 5-26
Insulation Options for Eaves

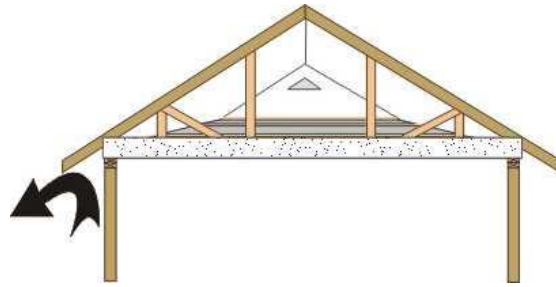

Problem - Roof deck compresses insulation and blocks air flow from soffit vent

Truss Roof

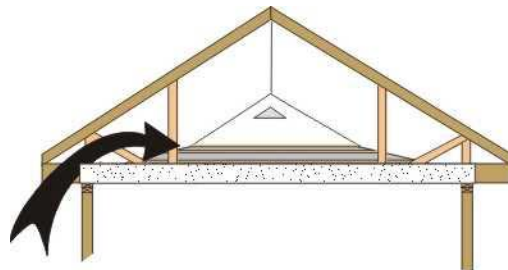

Solution - raised heel trusses
Insulation not compressed; air flow path is open

Wood-Framed Roof

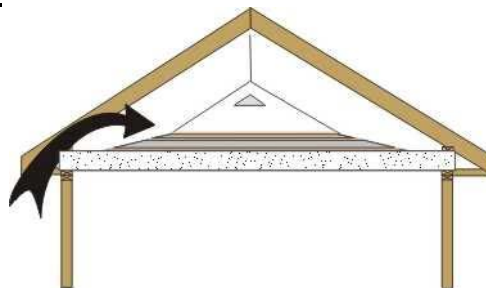

Solution - raised top plate
Insulation not compressed; air flow path is open

Problems with Recessed Lights

Standard recessed fixtures require a clearance of several inches between the lamp's housing and the attic insulation. Even worse, recessed fixtures leak air between the attic and the conditioned space. IC-rated (insulation contact rated) fixtures have a heat sensor switch that allows the fixture to be covered with insulation. However, these units also leak air. Airtight, IC-rated fixtures are permitted by the 2006 International Residential Code and the 2006 International Energy Conservation Code. Otherwise the non-airtight fixture must be installed in a sealed recess. Alternatives to recessed lights include surface-mounted ceiling fixtures and track lighting, both of which typically contribute less air leakage to the home. For more information on lighting, see chapter 9.

Figure 5-27
Airtight, IC-rated Recessed Lamps

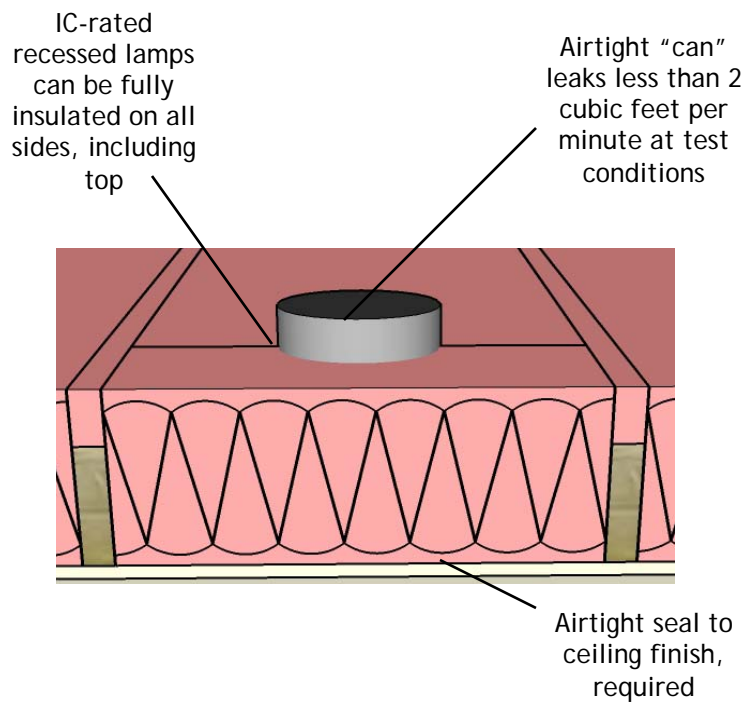

Cathedral Ceiling Insulation Techniques

Cathedral ceilings are a special case because of the limited space for insulation and ventilation within the depth of the rafters. Fitting in a 10-inch batt (R-30) and still providing ventilation is impossible with anything less than a 2x12 rafter. For the entire state, R-30 insulation is now required.

Building R-30 Cathedral Ceilings

Cathedral ceilings built with 2x12 rafters can be insulated with standard R-30 batts and still have adequate space for ventilation. Some builders use a vent baffle between the insulation and roof decking to ensure that the ventilation channel is maintained. If 2x12s are not required structurally, most builders find it cheaper to construct cathedral ceilings with 2x10 rafters and high density R-30 batts, which are 8¼- inches thick.

Some contractors wish to avoid the higher cost of 2x10 lumber and use 2x8 rafters. These roofs are usually insulated with R-19 batts. However, 2x10 rafters can be spaced 24 inches on center and may cost little more than 2x8 rafters spaced 16 inches on center.

If framing with 2x6 or 2x8 rafters, insufficient space is available for standard R-30 insulation. Higher insulating values can be obtained by installing rigid foam insulation between the rafters. However, foam is expensive and using deeper rafters with batt or loose-fill insulation may be substantially less costly.

**Figure 5-28
Cathedral Ceiling Insulation Options**

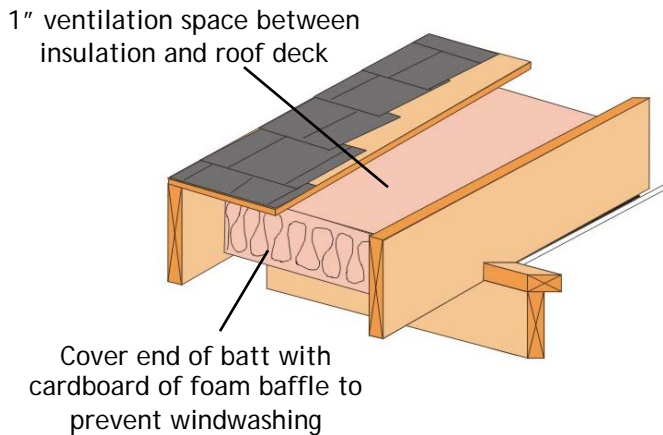

- Construction Options:
- 2x8 Rafter, R-30 foam
 - 2x10 Rafter, R-30 foam
 - 2x10 Rafter, moderate density R-30 batt
 - 2x12 Rafter, R-30 batt
 - 2x12 Rafter, blown-in cellulose, fiberglass or rock wool held in place

Scissor Trusses

Scissor trusses are another cathedral ceiling efficiency framing option. They have a greater roof pitch than ceiling pitch, thus creating more space than standard framing provides between the roof and the ceiling. Make certain that they have adequate room for both R-30 insulation and ventilation, especially at their ends, which form the eave section of the roof.

**Table 5-12
Economics of Cathedral Ceiling Insulation*
Compared to R-19 Batt**

	Energy Savings (\$/yr)	Extra Installed Costs (\$)	Annual Rate of Return	Extra Mortgage Costs (\$/yr)
R-25 Batt	28	87	34.2%	7
R-30 High Density Batt	43	150	30.7%	12

*For a 2,000 square-foot home with 25% vaulted ceiling located in Baton Rouge. Analysis assumes 2% annual fuel price escalation; mortgage is 30-year, 7% loan; the energy savings were estimated using REMRate v. 12.0 software.

Ceilings with Exposed Rafters

A cathedral ceiling with exposed rafters or roof decking is difficult and expensive to insulate well. Often, foam insulation panels are used over the attic deck as shown in Figure 5-29. However, to achieve R-30, 4- to 7-inches of foam insulation, costing \$1 to \$3 per square foot, is needed. Ventilation is also a problem and some shingle manufacturers do not offer product warranties unless

the outer roof decking is ventilated. In homes where exposed rafters are desired, it may be more economical to build a standard, energy efficient cathedral ceiling and then add exposed decorative beams underneath. Note that homes having tongue-and-groove ceilings can experience substantially more air leakage than those with, drywall ceilings. Install a continuous air barrier, sealed to the walls, above the tongue-and-groove roof deck.

Figure 5-29
Cathedral Ceiling – Exterior Roof Insulation

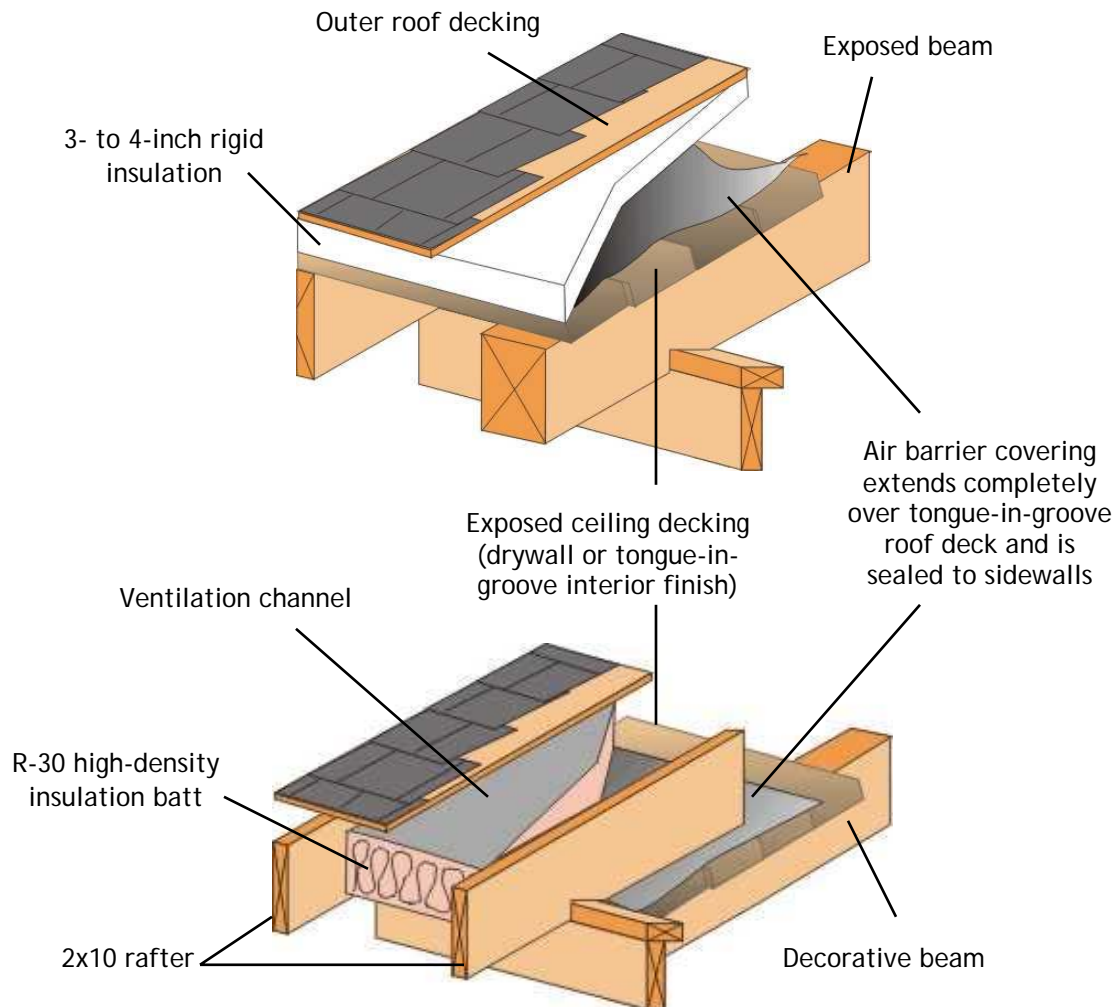

Radiant Heat Barriers

Radiant heat barriers (RHBs) are reflective materials that can reduce summer heat gain in attics and walls. While not generally a substitute for insulation, they can be used in concert with minimum levels of insulation to lower air conditioning costs during warm and hot weather. Their use should be carefully considered as they may also act as vapor barriers causing condensation within structures and insulation. If used, in most cases a perforated material should allow water vapor to pass through the material.

The chapter on Natural Cooling provides more detailed information on radiant heat barriers. They have a controversial history in the Southeastern United States because manufacturers oversold their

benefits during the late 1980s and early 1990s. In particular, some sales representatives made excessive claims about the performance of the product and priced it too high to provide a reasonable payback.

Radiant heat barriers do not have to be expensive. Many are available for less than \$0.15 per square foot. Because RHBs can reduce cooling bills by 10% to 20%, inexpensive products can be cost effective.

Chapter 6

Windows and Doors

Windows and doors are often the architectural focal point of residential designs, yet they typically provide the lowest insulating value in the building envelope. Although recent developments in energy efficient products have markedly improved the efficiency of windows and doors, they still pose a major energy liability.

Windows

Windows connect the interior of a house to the outdoors, provide ventilation and daylight, and are key aesthetic elements. In passive solar homes, windows can provide a significant amount of heat for the homes during the winter.

The type, size, and location of windows greatly affect heating and cooling costs. Select high quality windows, but shop wisely for the best combination of price and performance. Many home construction budgets have been exceeded by spending thousands of additional dollars on premium windows with marginal energy savings. Good windows do not have to be expensive.

In general, windows need to be double-glazed, low-e, well-built, and have good weather stripping in order to meet the provisions of the building code. Carefully evaluate added features, such as inert gas fill between glazing layers and tinted or reflective units – they may provide additional energy savings at relatively low extra cost.

Table 6-1
Economics of Energy Conserving Windows and Doors

Type of Treatment	Energy Savings (\$/yr)	Extra Costs (\$)*	Rate of Return	Extra Annual Mortgage (\$/yr)**
Windows (compared to single-glazed windows)				
Double-glazed (R-1.8)	116	660	19%	53
Double-glazed with low-e coating (R-2.4)	157	1,110	16%	89
Double-glazed with low-e coating and inert gas fill (R-2.7)	186	1,260	17%	101
Triple-glazed, low-e coating, inert gas fill (R-3.2)	235	1,710	15%	138
Quadruple-glazed, low-e coating, inert gas fill (R-5)	245	2,900	8%	232
Doors (compared to solid wood doors)				
Foam-insulated doors (R-5)	5	20	26%	2
Storm doors over wood doors (R-3.2)	3	90	n/a	9

*Savings and costs are for a home with 300 square feet of windows and 2 exterior doors located in Baton Rouge, LA

**Extra annual mortgage for 30 year loan @ 7% annually.

**Figure 6-1
Window Anatomy**

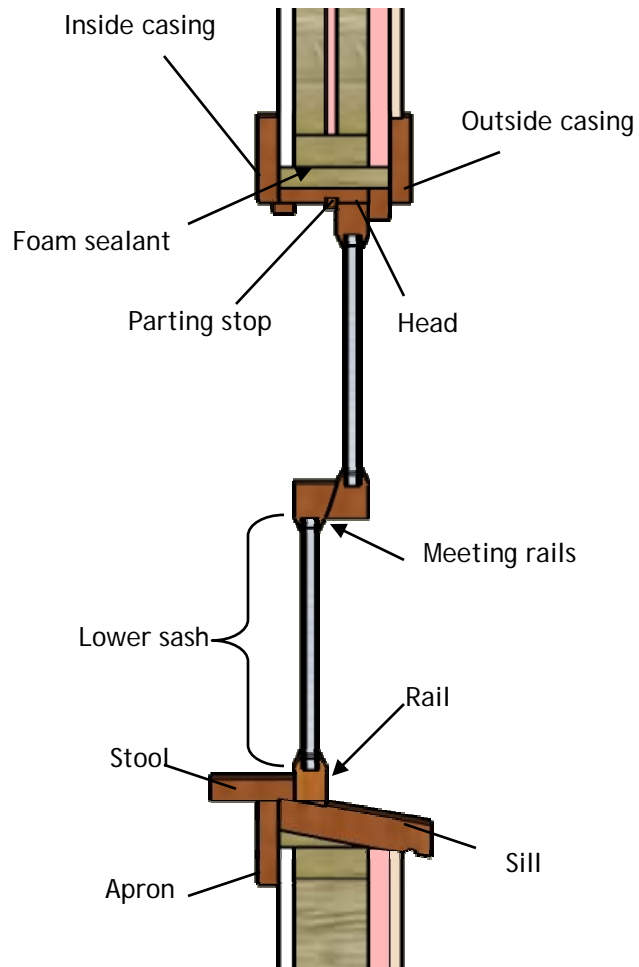

To understand window technologies, it is helpful to know how they lose and gain heat. See the following list of ways that heat is moved through windows:

- Conduction through the glass, center and edge of glazing unit, and frame
- Convection across the air space in double- and triple-glazed units
- Air leakage around the sashes and the frame
- Radiant energy from the sun transmitted through the glazing
- Radiant energy from inside emitted to the to the cold winter air

Figure 6-2
Winter Heat Loss in a Typical Double-glazed Window

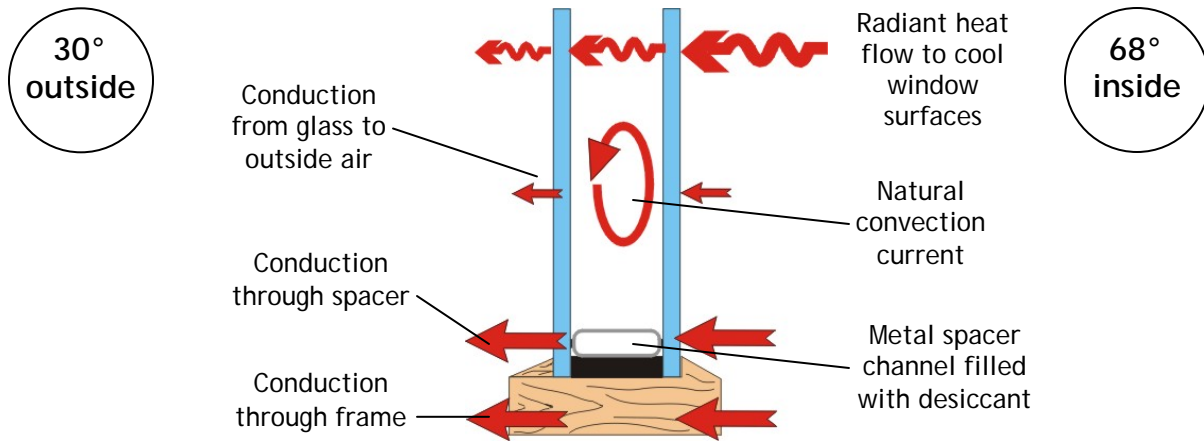
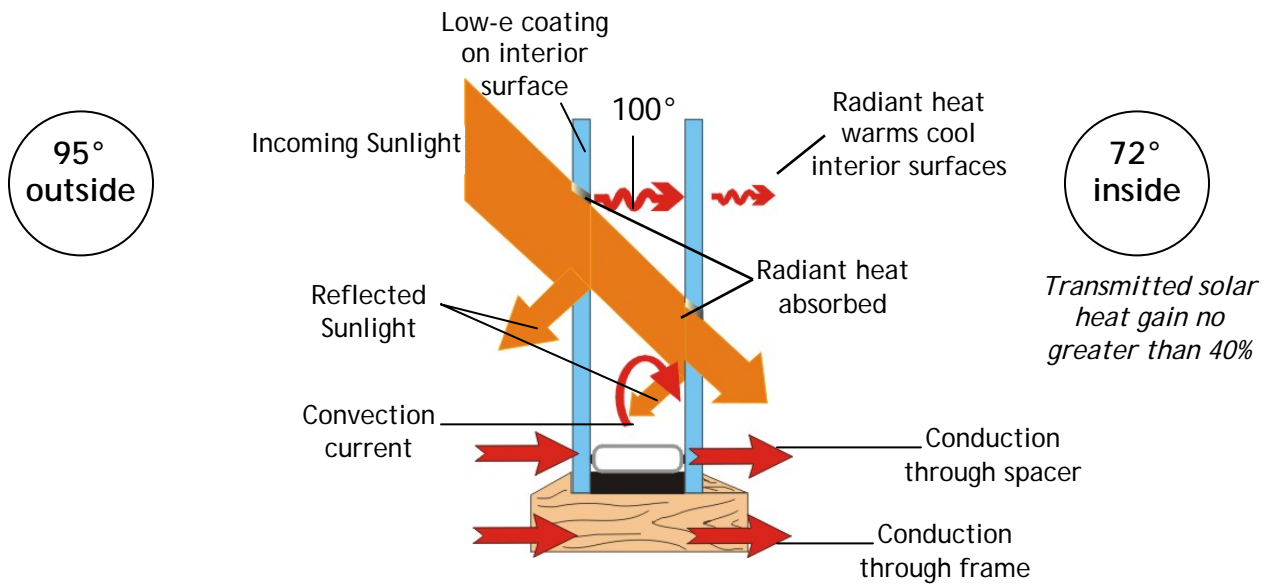

Figure 6-3
Summer Heat Gain in a Typical Double-glazed, Low-e Window



Goals of Efficient Windows:

- Low U-values – a minimum of double-glazed glass (U-0.65) with thermal breaks in metal-framed units.
- Low air leakage rates
 - Less than 0.25 cfm per linear foot of sash opening for double hung windows
 - Less than 0.10 cfm per linear foot for casement, awning, and fixed windows
- Moderate to high transmission of visible light (Visible Transmittance of 50% to 80%)
- Low transmission rates of ultraviolet and infrared light

Measurements of Window Performance

When shopping for windows, it is useful to know some of the following basic window terminology:

NFRC - The National Fenestration Rating Council is a national nonprofit organization that publishes a directory of windows that have been tested according to their criteria. The NFRC rating system is described later in the chapter. Builders should use windows with an NFRC label, as their listed insulating values and air tightness have been verified by independent laboratories.

- **NFRC Label** - NFRC adopted a new energy performance label in 2005. It lists the manufacturer, describes the product, provides a source for additional information, and includes ratings for one or more energy performance characteristics.

R-value and U-value - These are ratings given for the insulating values of components. R-values refer to the resistance to heat flow; therefore, the higher the R-value, the better the insulation. U-values measure the ability of the component to conduct heat and are the inverse of R-values, meaning that a low U-value corresponds to a high R-value. Standard wood, double-glazed windows have U-values of 0.5 (1/2), thus having R-values of about 2. A typical new window having a low-emissivity coating and an inert gas fill might have a U-value of about 0.30 and R-value of 3.3.

Solar Heat Gain Coefficient - Commonly referred to as SHGC on NFRC labels, it is the percentage of solar energy that actually penetrates a window compared to what would enter through the total window area. A window with a SHGC of 80% allows 4 times as much solar radiation to enter a home as a window with a SHGC of 20%. To reduce summer cooling bills, windows with low SHGC values should be used. Tinted and reflective windows, or units with solar films, generally have low SHGCs compared to clear glass, but not low enough to comply with 2006 IRC.

To better understand solar heat gain, it is important to recognize that sunlight consists of more than just visible light. Figure 6-3 shows the relative energy intensity of the full spectrum of sunlight. The spectrum is broken into ultraviolet (UV), visible, and near infrared. The percentage of energy coming from each range of the spectrum is determined using the areas under the curve.

Figure 6-4
Relative Intensity of the Solar Spectrum

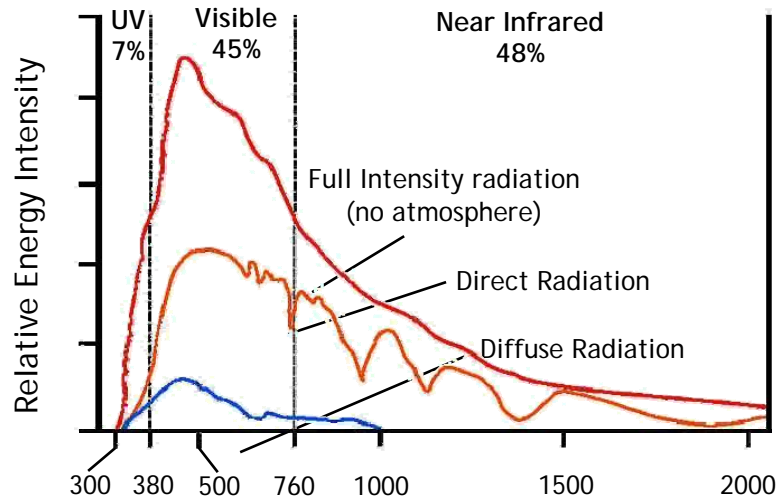

Shading Coefficient - This is an older method of measuring solar heat transfer. This method of indicating the relative solar transmission through windows assigns single-glazed, clear windows a shading coefficient of 1.0. Double-glazed, clear windows have a shading coefficient of 0.87. If you know the shading coefficient of a window, you can find the SHGC by multiplying the shading coefficient by 0.88.

Visible Light Transmittance - Commonly denoted as VT, this is a measure of the percentage of available light normally visible to humans that penetrates a window. Higher visible transmittances are typically desirable. Allowing more visible light to enter the home will reduce the amount of power required for the lighting system.

Infiltration - The rated air leakage of a window is usually measured in cubic feet per minute (cfm) per linear foot of the seam around the window unit. Double-hung units are typically the leakiest, while fixed units are the tightest.

Window Types - There are several different window types available on the market today. All types are generally available with wood, pre-primed wood, aluminum clad, or vinyl frames.

- **Double-hung and single-hung windows** - most traditional, leakiest, can only open halfway when ventilating.
- **Fixed windows** - very low air leakage, provide no ventilation, have the least interrupted view, less expensive.
- **Casement, Awning, and Hopper windows** - low air leakage, open fully for ventilation but sash may receive direct rainfall, more expensive.

High Efficiency Windows

The window industry has unveiled an exciting array of higher efficiency products. The most notable developments include:

- Low-emissivity coatings which reduce radiant heat flow
- Tighter weather stripping systems to lower air leakage rates
- Inert gas fills, such as argon and krypton that help reduce convection in the air space between layers of glazing, thus increasing the insulating values of the windows
- Thermal breaks to reduce heat losses through highly conductive glazing systems and metal frames
- Windows with low transmission rates of infrared and ultraviolet light

Table 6-2
Cost Comparison of Window Alternatives
(\$/square foot of rough opening)

Type of Window	Builder's Quality	Premium Quality
Single Glazed:		
Double-hung wood	5	11 - 18
Double-glazed:		
Double-hung - wood	8	11 - 18
Double-hung - vinyl or aluminum clad	10	12 - 25
Casement or awning - wood	14 - 18	20 - 27
Casement or awning - vinyl or aluminum clad	19 - 23	25 - 31
Sliding glass door - metal	5 - 8	7 - 10
Sliding glass door - wood	9 - 14	10 - 15
Fixed/hinged operable door combination	n/a	11 - 18

*Sealed, double-glazed glass units cost about \$2.50 per square foot. Labor and trim may cost about \$7 per square foot of rough opening.

Table 6-3
Sample Window Performance Characteristics

Type	U-value	Solar Heat Gain Coefficient	Visible Light Transmittance	Infiltration (cfm/linear ft of crack)
DH, 1G, wood*	1.10	0.79	0.90	0.20 - 0.35
DH, 1G, metal	1.30	0.79	0.90	0.50 - 0.98
DH, 2G, wood, bronze tint	0.49	0.55	0.61	0.15 - 0.30
DH, 2G, wood or vinyl, Low-E	0.39	0.31	0.53	0.15 - 0.30
CS, 2G, low-e, wood	0.38	0.50	0.74	0.07 - 0.15
CS, 2G, low-e, inert gas fill, wood	0.30	0.50	0.74	0.07 - 0.15
CS, 2G, low-e, inert gas fill, wood, tinted	0.29	0.31	0.72	0.07 - 0.15
DH, 3G, low-e inert gas fill, wood	0.24	0.37	0.68	0.15 - 0.30
DH, 4G, low-e, inert gas fill, wood	0.17	0.30	0.62	0.15 - 0.30

*Ratings shown are for the entire window unit, not just the center of glass. Double and triple glass systems have 0.5" air spaces between the layers of glass.

**DH = Double Hung, CS = Casement (awning and hopper would have similar air leakage values, fixed would have lower air leakage). 1G = Single glazed, 2G = double glazed, etc.

Thermal Breaks and Window Spacers

Thermal breaks in metal window frames are of particular importance. Metal is a very poor insulator, thus it conducts heat well. A thermal break improves insulating values by separating inside and outside pieces of the metal window frame with an insulating material. Always specify windows with thermal breaks, listed as “T.I.M.” (thermally insulated metal) when purchasing metal windows. When shopping for windows, you can find the total U-value on the NFRC label.

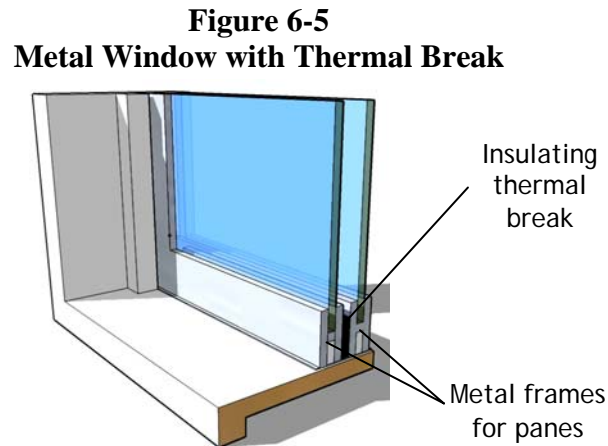

Low-Emissivity Coatings

Low-emissivity (Low-e) coatings are designed to reduce radiant heat flow through multi-glazed windows. Some surfaces, such as flat black metal used on wood stoves, have high emissivities and radiate heat easily. Other surfaces, such as shiny aluminum, have low emissivities and radiate little heat, even at low temperatures. Most low-e coatings are composed of a layer of silver applied between two protective layers.

There are many benefits of low-e windows in addition to reducing the summer heat gain and winter heat loss. They screen ultraviolet radiation, which can, in turn, reduce fading of interior surface finishes. In winter, the interior surface of the glass is warmer, which increases comfort and helps prevent condensation from forming.

Spectrally Selective Low-E Coatings

These are the most advanced form of Low-E coatings, usually multiple coatings, which provide the lowest SHGCs while providing good visible transmission. They stop nearly 100 percent of the ultraviolet and infrared from passing through.

Figure 6-6 shows window surfaces numbered 1 to 4 from the exterior surface, 1, to the interior surface, 4. In Louisiana and other areas where the cooling is more prevalent than heating, the low-e coating should be on surface 2.

Figure 6-6
Low-e, Gas-filled Windows

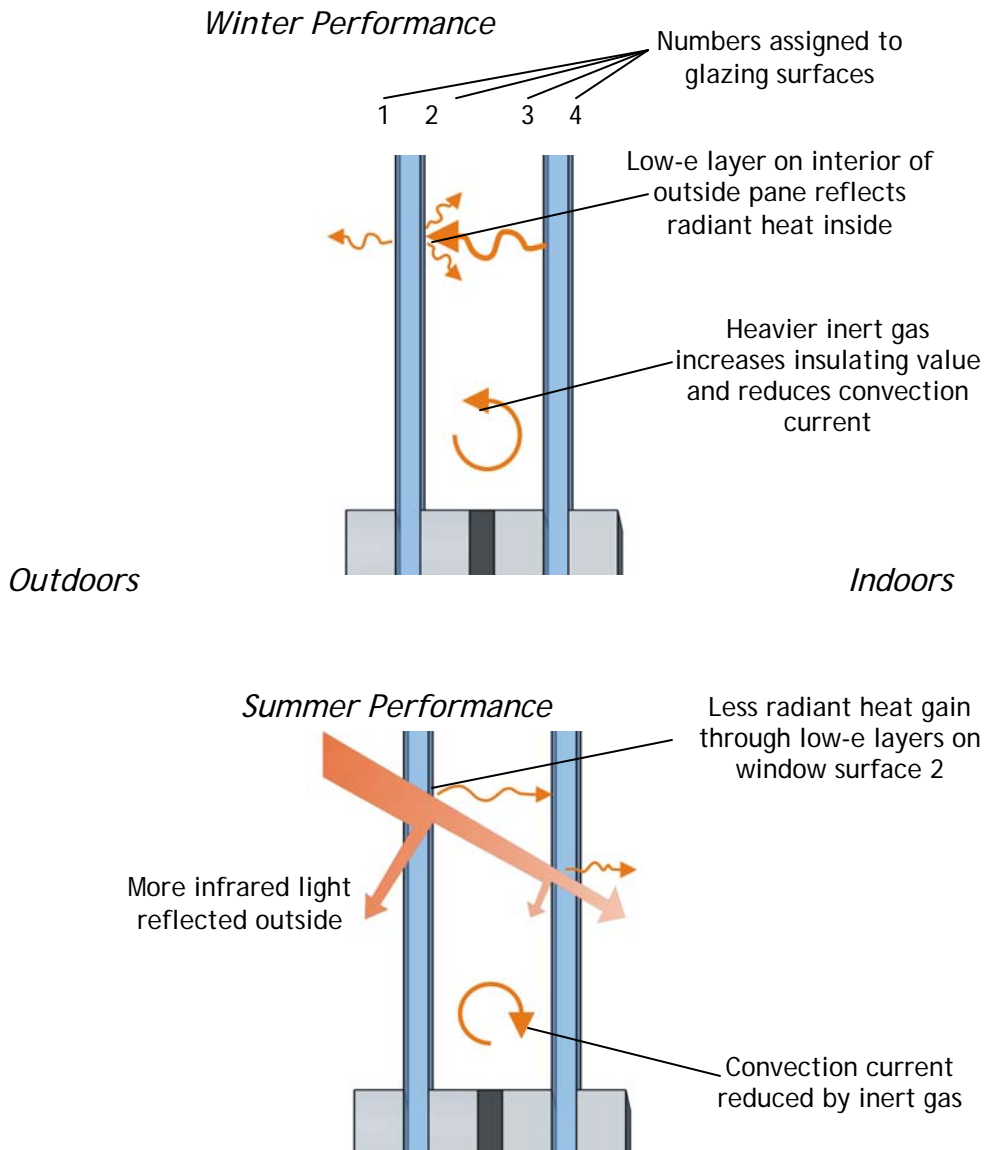

Caution about Window Insulating Values

New energy codes require manufacturers to report window R-values consistently and accurately. The National Fenestration Rating Council, NFRC, offers a testing program for window and door products. The NFRC reports an average whole window U-value. If windows used in your home are listed by the NFRC, they will include a label showing test data for your windows.

Window insulating values are reported in U-values, the inverse of R-values. Single-glazed windows generally have average R-values of 1.0 and thus have U-values of 1.0. Double-glazed products may have R-values higher than 4.0, or U-values of lower than 0.25 ($1/R = 1/4 = 0.25$).

Sometimes insulating values are reported through the glass surface alone. However, these values do not apply to the entire window assembly.

Windows have a frame or sash; spacer strips that hold apart the sections of glass in a double-glazed window; and a jamb. These components each affect the insulating value of the window. Window frames and sashes reduce the transparent glass area, thus reducing the solar heat gain coefficient of the window. Spacer strips separating the glass layers add areas of direct conduction through the edge of the glazing unit. Thermal breaks reduce the conduction, improving the performance of the window. The claimed U-value should reflect the overall insulating value of all of the components.

NFRC labels show the following key window performance features:

- Air leakage rates
- Solar heat gain coefficient
- Visible light transmittance
- Condensation Resistance

Figure 6-7
NFRC Label

		World's Best Window Co. Millennium 2000+ Vinyl-Clad Wood Frame Double Glazing • Argon Fill • Low E Product Type: Vertical Slider	
ENERGY PERFORMANCE RATINGS			
U-Factor (U.S./I-P)		Solar Heat Gain Coefficient	
0.35		0.32	
ADDITIONAL PERFORMANCE RATINGS			
Visible Transmittance		Air Leakage (U.S./I-P)	
0.51		0.2	
Condensation Resistance			
51		—	
<small>Manufacturer stipulates that these ratings conform to applicable NFRC procedures for determining whole product performance. NFRC ratings are determined for a fixed set of environmental conditions and a specific product size. NFRC does not recommend any product and does not warrant the suitability of any product for any specific use. Consult manufacturer's literature for other product performance information. www.nfrc.org</small>			

Proper Window Installation

- Step 1: Make sure window fits in rough opening and that the sill is level
- Step 2: Install window level and plumb according to the manufacturer's instructions
- Step 3: Use a dry, pliable foam gasket or non-expanding foam sealant to seal between the jamb and the rough opening, or stuff the gap with backer rod or insulation and cover the insulation with caulk (remember, most insulation does not stop air leaks – it just serves as a filter)
- Step 4: If using an interior air barrier (such as drywall) or an exterior air barrier (such as housewrap), seal the barrier to the window jamb with long-life caulk or other appropriate, durable sealant.

Figure 6-8
Inside Window Temperatures in Cold Weather
(when 75°F inside and 20°F outside)

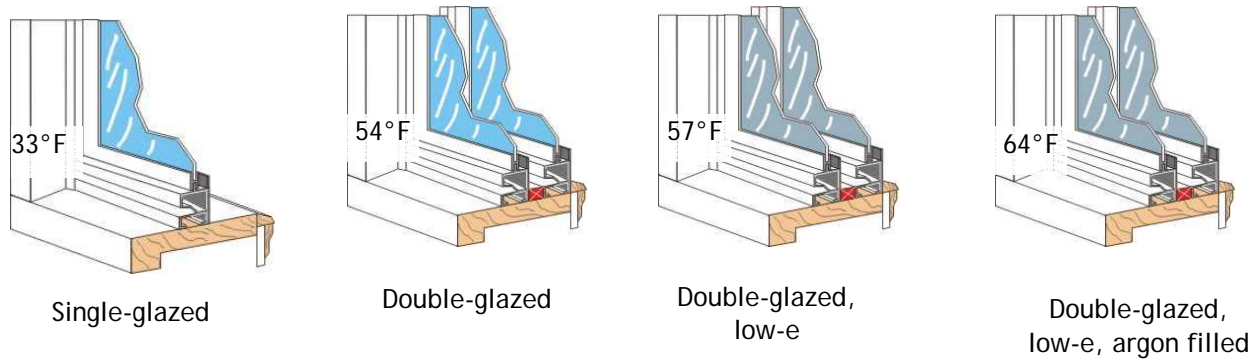

Window Shading Options

Well-designed homes carefully consider window location and size. In summer, unshaded windows can double the cost of cooling the home. Year round, poorly designed windows can cause glare, fading of fabrics, and reduced comfort.

The effectiveness of different window shading options depends on the composition of the incoming sunlight. Sunlight reaches the home in three forms: direct, diffuse, and ground reflected. On a clear day, most sunlight is direct, traveling as a beam from the sun to a home’s windows without obstruction. Figure 6-8 shows that most of the direct sunlight striking windows in winter is transmitted into the home. However, in summer, sunlight hits south-facing windows at a steeper angle, and much of the direct sunlight is reflected.

The majority of the sunlight entering south-facing windows in the summer is either diffuse – bounced between particles in the sky until it arrives as a bright haze – or is reflected off of the ground. In developing a strategy for effectively shading windows, consider both direct and indirect sources of sunlight. Overhangs, long thought to be totally effective for shading south-facing windows, are best at blocking direct sunlight and are therefore only a partial solution. Other shading options include landscaping and trees, awnings, exterior and interior shades, window films, and solar window screens.

Figure 6-9
Composition of Solar Heat Gain into Home

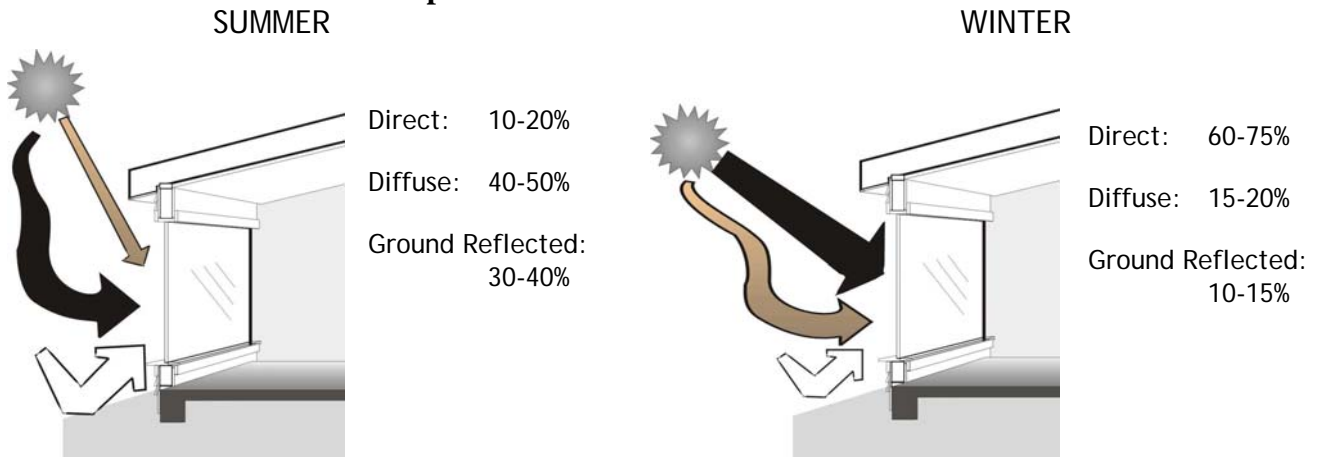

Overhangs

Overhangs shade direct sunlight on windows facing within about 30 degrees of south. Overhangs on east and west windows are less effective because of the low angle of the sun around sunrise and sunset. Overhangs above south-facing windows should provide maximum shade for the glazing in midsummer – around July 21- yet still allow access to winter sunlight. For a standard 8-foot wall with windows, the overhang should be 2 to 2 ½ feet in length. Figure 6-10 shows how to size overhangs for south-facing windows.

Retractable awnings allow full winter sunlight, yet provide effective summer shading. They should have open sides or vents to prevent accumulation of hot air underneath. Awnings may be more expensive than other shading options, but they also serve as an attractive design feature.

Figure 6-10
Guidelines for Overhangs

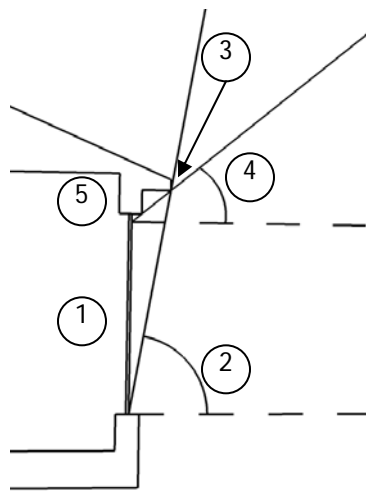

Size south overhangs using the adjacent diagram and these steps:

1. Draw to scale the window and wall to be shaded.
2. Draw the summer sun angle upward from the bottom of the glazing.
3. Extend the overhang until it intersects the summer sun angle line.
4. Draw the line at the winter sun angle from the bottom edge of the overhang to the wall.
5. Use a solid wall above the line where the winter sun hits. The portion of the wall below that line should be glazed.

Table 6-4
Summer and Winter Sun Angles
(Degrees from Horizon at Mid-day)

	July 21	January 21
Alexandria	78.5	38.5
Baton Rouge	79.5	39.5
New Orleans	80.0	40.0
Shreveport	77.5	37.5

Interior Shading Options

Shutters and shade located inside the house include curtains, roll-down shades, and Venetian blinds. More sophisticated devices such as shades that slide over the windows on a track and interior movable insulation are also available.

Interior shutters and shades are generally the least effective shading measures because they block sunlight that has already entered the room. However, if windows do not have exterior shading, use interior measures. The most effective interior treatments are solid shades with a reflective surface facing outside. In fact, simple white roller blinds keep the house cooler than more expensive louvered blinds, which do not provide a solid surface and allow trapped heat to migrate between the blinds and the house.

Reflective film, which adheres to glass and is found often in commercial buildings, can block up to 85% of incoming sunlight. It is best suited for use on west-facing windows. These films are not recommended for windows that experience partial shading because they absorb sunlight and heat the glass unevenly. This uneven heating may break the glass or ruin the seal between double-glazed units.

The installed cost of reflective films is higher than \$4 per square foot. Price should not be the sole criterion when selecting an installer – quality is a vital consideration affecting the appearance of the house and the beauty of the view to the outside.

Most window manufacturers offer tinted windows, which reduce Solar Heat Gain Coefficients. The window tints add color, such as green, amber, gray, or a reflective finish to the window. These tints are often inexpensive, costing only \$3 to \$10 extra per window for many units. However, the tint is permanent, so incoming sunlight will be blocked in both summer and winter.

Exterior Shading Options

Exterior window shading treatments are effective cooling measures because they block both direct and indirect sunlight outside of the home. Hinged decorative exterior shutters which close over the windows are excellent shading options. However, they obscure the view, block daylight completely, may be expensive, are subject to wear and tear, and may be difficult for many households to operate on a daily basis. They work best in hot, sunny climates, like that of Louisiana, where they can be closed for weeks at a time.

If they are hurricane protection shutters as well they may be worth the price to some. They can be closed on those windows that need shading and open on all the rest letting in daylight. When storms approach they can be fastened closed to protect the windows from wind blown debris.

Solar shade screens are an excellent exterior shading product with a thick weave that blocks 70 percent or more of all incoming sunlight. The screens absorb sunlight, so they should be used on the exterior of the windows only. From outside, they look slightly darker than regular screening, but from the inside many people do not detect a difference. Most products also serve as insect screening and come in several colors. They may be removed in winter to allow full sunlight through the windows. More expensive alternatives to the fiberglass shade screen are thin, louvered metal screens that block sunlight, but still allow a view from inside to outside.

According to the U.S. Department of Energy Report, “Landscaping for Energy Efficiency” (DOE/GO-10095-046), careful landscaping can save up to 25% of a household’s energy consumption for heating and cooling. Trees and vines are very effective means of shading in the summer month, as well as providing protection from winter winds. Also, shrubs or groundcover outside of windows can reduce the amount of ground reflected light entering the home.

Select Shading Options Wisely

It is important to understand that not all shading is created equally. Exterior shading is inherently more effective than interior shading. This is because exterior shading stops the heat before it enters the home, whereas interior shading tries to stop the heat after it has already entered the home. Each type of shading also has its own benefits and drawbacks. Selecting shading options depends on several variables to determine effectiveness. Not only are there different types of products for shading windows, but variations of effectiveness of products. For instance, vinyl blinds do not reject as much heat as aluminum blinds. It is important to consider all factors including window orientation, aesthetic value, and cost when selecting shading options.

Special Considerations for Hurricane Prone Regions

A large part of Louisiana is required to have added protection from the effects of hurricanes. Portions of Louisiana falling south of the 100 MPH wind load line, as per the 2003 version of the IRC, must either have impact-resistant glass installed or be protected from windborne debris by storm shutters or other covering. These windows must also be able to resist the cyclical loading of high pressure differences between the inside and outside of the home. One drawback of impact-resistant glass is that it poses a safety hazard in the event of a fire. When a window must be entered to rescue an occupant, the impact-resistant glass seriously impedes the firemen, as it will not shatter and allow entry. Storm shutters, when used properly, provide protection from windborne debris while allowing safety personnel to enter through the window in the event of an emergency.

Future Window Options

Electronic Windows

A new type of windows is composed of special materials that can darken the glazing by running electricity through the unit. Some manufacturers already have prototypes of these technologically advanced windows in operation. At night and on sunny days, an electric switch can be turned on to render the windows virtually opaque.

“Solid” Windows

Another new window technology uses an aerogel up to one inch thick between layers of glazing. Aerogels are produced by replacing the liquid in a gel with a gas. The result is a very low-density material that feels similar to expanded polystyrene. Aerogels are effective at reducing all three forms of heat transfer. However, the effectiveness against each form of heat transfer depends on the type of aerogel used. These windows offer increased insulating values, but are not completely transparent and are not economical in Louisiana.

Doors

Exterior wooden doors have low insulating values, typically R-1.8 to 2.2. Storm doors increase the R-value only to about R-3.0 and are not good energy investments. The best energy-conserving alternative is a metal or fiberglass insulated door. Metal doors have a foam insulation core which can increase the insulating value to R-7 or greater. They usually cost no more than conventional exterior doors and come in decorative styles, complete with raised panels and insulated window panes.

Insulated metal or fiberglass doors usually have excellent weatherstripping and long lifetimes. They resist warping and offer increased security; however, they are difficult to trim, so careful installation is required. Table 6-1 includes the costs and savings of energy conserving doors.

As with windows, it is important to seal the rough openings. Thresholds should seal tightly against the bottom of the door and must be sealed underneath. After the door is installed, check it carefully when closed to see if there are any air leaks.

Glass in Doors

Special consideration must be given to doors that include glass areas. Whereas solid doors must only deal with conduction through the unit, doors with glass areas must also contend with solar heat gain. Doors with half height glass must meet the SHGC requirements of the IRC.

Accessible Design

Almost one out of ten people will suffer from physical disabilities during their lifetime. Designing homes to provide accessibility for the physically impaired adds little to the cost of a home. One important feature is to design both exterior and interior door openings and hallways 3' wide to allow passage of a wheelchair or walker.

Overall Window and Door Recommendations

- Use double-glazed windows with low-e coatings as required by IRC.
- South-facing windows should be shaded with about a 2-foot horizontal overhang for single-story windows.
- East and west facing windows should have low Solar Heat Gain Coefficients (under 0.40) through the use of tinting, reflective or selective coatings, or window films. West window areas, in particular, should be limited to avoid afternoon solar gain.
- North-facing windows are excellent for indirect lighting and ventilation.
- Insulated doors should be used.

Chapter 7

Heating, Ventilation, and Air Conditioning

One of the most important decisions regarding a new home is the type of heating and cooling system to install. Equally critical is the heating and cooling contractor selected, as the operating efficiency of a system depends as much on proper installation as it does on the performance rating. Keys to obtaining the design efficiency of a system in the field include:

- Sizing and selecting the system for the heating, cooling, and dehumidification load of the home being built
- Correct design of the ductwork or piping
- Proper installation and charging of the HVAC unit
- Insulating and sealing all ductwork or piping

Types of HVAC Systems

There are two primary types of central heating systems - forced-air systems and radiant heating systems. Most new homes have forced-air heating and cooling systems - either using a central furnace and air conditioner or a heat pump. Figure 7-1 shows that in forced-air systems a series of ducts distribute the conditioned heated or cooled air throughout the home. The conditioned air is forced through the ducts by a blower, located in a unit called an air handler.

Most homes in Louisiana have three choices for central, forced-air systems: electric resistance heat or fuel-fired furnaces with electric air conditioning units or electric heat pumps, which can be either air-source or ground-source (geothermal). The best system for each home depends on many factors - cost, comfort, efficiency, annual energy use, availability, and local prices for fuels and electricity.

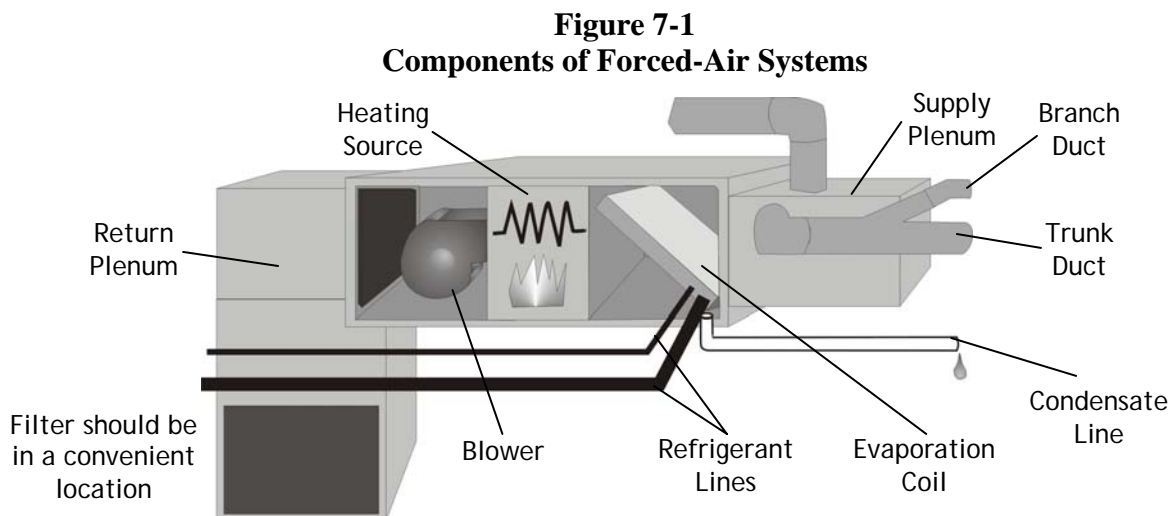

When considering a HVAC system for a residence, remember that energy efficient homes have less demand for heating and cooling, so substantial cost savings may be obtained by installing smaller units that are properly sized to meet the load. Because energy bills in more efficient homes are

lower, higher efficiency systems will not provide as much annual savings on energy bills and may not be as cost effective as in less efficient houses.

Sizing

It is important to size heating and air conditioning systems properly. Not only does oversized equipment cost more, but it can waste energy and may decrease comfort. Do not rely on rule-of-thumb methods to size HVAC equipment. Many contractors select air conditioning systems based on a rule such as 500 square feet of cooled area per ton of air conditioning (a ton provides 12,000 Btu per hour of cooling). Instead, use a sizing procedure such as:

- Calculations in Manual J published by the Air Conditioning Contractors Association
- Similar procedures developed by the American Society of Heating, Refrigeration, and Air Conditioning Engineers (ASHRAE)
- Software procedures developed by electrical or gas utilities, the U.S. Department of Energy, HVAC equipment manufacturers, or private software companies

The heating and cooling load calculations rely on the size and type of construction for each component of the building envelope, as well as the heat given off by the lights, people, and equipment inside the house. If a zoned heating and cooling system is used, the loads in each zone should be calculated separately.

Simplified rules of thumb typically provide oversized heating and cooling systems for more efficient homes. Oversized units cost more to install, increase energy bills, suffer greater wear and tear, and often may not provide adequate dehumidification. It takes about 15 minutes for most air conditioners to reach peak efficiency. During extreme outside temperatures (under 32°F in winter and over 88°F in summer) the system should run about 80% of the time. Oversized systems cool the home quickly and often do not operate long enough to reach peak efficiency.

Proper sizing includes designing the cooling system to provide adequate dehumidification. In Louisiana's humid climate it is critical to calculate the latent load - the amount of dehumidification needed for the home. If the latent load is ignored, the home may become uncomfortable due to excess humidity.

The Sensible Heating Fraction (SHF) designates the portion of the cooling load for reducing indoor temperatures (sensible cooling). For example, in a HVAC unit with a 0.75 SHF, 75% of the energy expended by the unit goes to cool the indoor air. The remaining 25% goes for latent heat removal - taking moisture out of the air in the home. The Manual J system sizing procedure includes calculations to estimate latent load.

Many homes in Louisiana have design SHFs of approximately 0.7, that is, 70% of the cooling will be sensible and 30% latent. Systems that deliver less than 30% latent cooling may fail to provide adequate dehumidification in summer.

Temperature Controls

The most basic type of control system is a heating and cooling thermostat. Programmable thermostats, also called setback thermostats, can be big energy savers for homes by automatically adjusting the temperature setting when people are sleeping or are not at home. Be certain that the programmable thermostat selected is designed for the particular heating and cooling equipment it will be controlling. This is especially important for heat pumps, as an improper programmable thermostat can actually increase energy bills.

A thermostat should be located centrally within the house or zone on an interior wall. It should not receive direct sunlight or be near a heat-producing appliance. A good location is often 4 to 5 feet above the floor in an interior hallway near a return air grille.

The interior wall, on which the thermostat is installed, like all walls, should be well sealed at the top and bottom to prevent circulation of cool air in winter or hot air in summer. Some homeowners have experienced excessive energy bills and discomfort for years because air from the attic leaked into the wall cavity behind the thermostat and caused the cooling or heating system to run much longer than needed.

Multiple HVAC Zones

Larger homes often use two or more separate heating and air conditioning units for different floors or areas. Multiple systems can maintain greater comfort throughout the house while saving energy by allowing different zones of the house to be at different temperatures. The greatest savings come when a unit serving an unoccupied zone can be turned off.

Rather than install two separate systems, HVAC contractors can provide automatic zoning systems that operate with one system. The ductwork in these systems typically has a series of thermostatically controlled dampers that regulate the flow of air to each zone. Although somewhat new in residential construction, thermostats, dampers, and controls for zoning large central systems have been used for years in commercial buildings.

If your heating and air conditioning subcontractor feels that installing two or three separate HVAC units is needed, have them also estimate the cost of a single system with damper control over the ductwork. A single, larger system running longer is usually more efficient than separate systems.

Such a system must be carefully designed to ensure that the blower is not damaged if dampers are closed to several supply ducts. In this situation, the blower still tries to deliver the same air flow as before, but now through only a few ducts. The reduced air flow creates back pressure against the blades of the blower and may cause damage to the motor. There are three primary design options:

1. Create two zones and size the ductwork so that when the damper to one zone is closed, the blower will not suffer damage. The higher pressure can possibly damage the duct work as well, but that will not be noticed.
2. Install a manufactured system that uses a dampered bypass duct connecting the supply plenum to the return ductwork. The control system always allows the same approximate volume of air to circulate.
3. Use a variable speed HVAC system. Because variable speed systems are usually more efficient than single-speed systems, they will further increase savings.

Figure 7-2
Automatic Zoned System with Dampered Bypass Duct

Air flow to both zones:

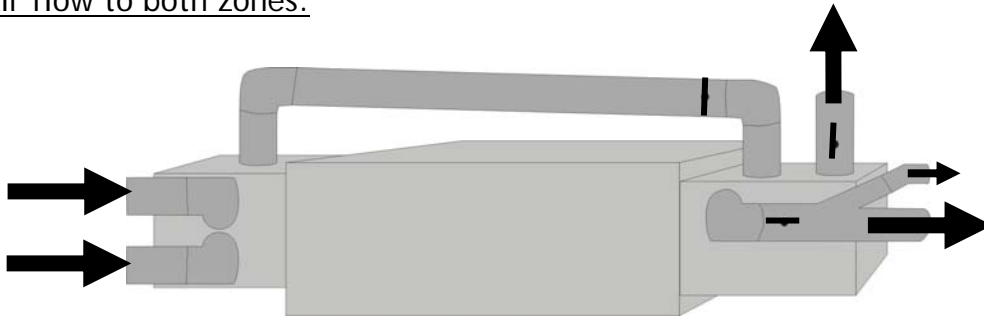

Air flow to one zone:

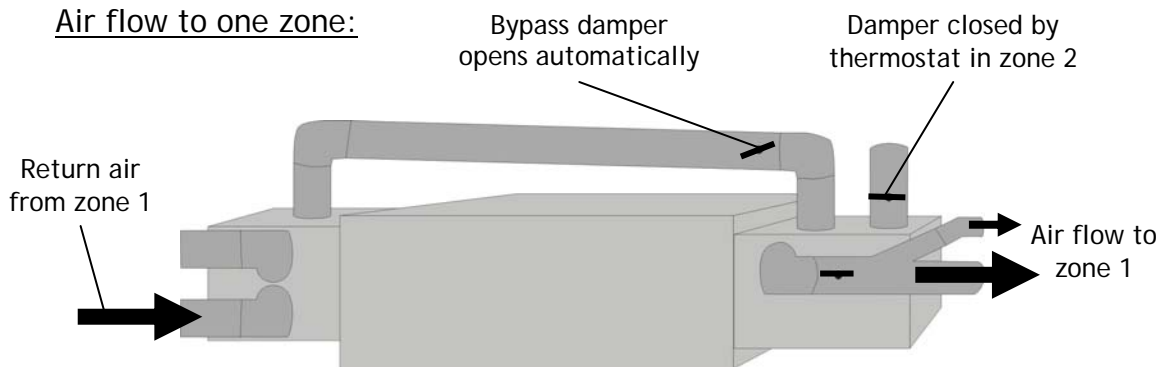

Air Conditioning Equipment

Air conditioners and heat pumps work similarly to provide cooling and dehumidification. In the summer, they extract heat from inside the home and transfer it outside. In winter, a heat pump reverses this process and extracts heat from outside and transfers it inside.

Both systems typically use a vapor compression cycle, which is described in Figures 7-3 and 7-4. This cycle circulates a refrigerant - a material that increases in temperature significantly when compressed and cools rapidly when expanded. The exterior portion of a typical air conditioner is called the condensing unit and houses the compressor, which uses most of the energy, and the condensing coil.

The inside mechanical equipment, called the air handling unit, houses the evaporator coil, the indoor blower, and the expansion or throttling valve. The controls and ductwork for circulating cooled air to the house complete the system.

Figure 7-3
Air Conditioning with the Vapor Compression Cycle

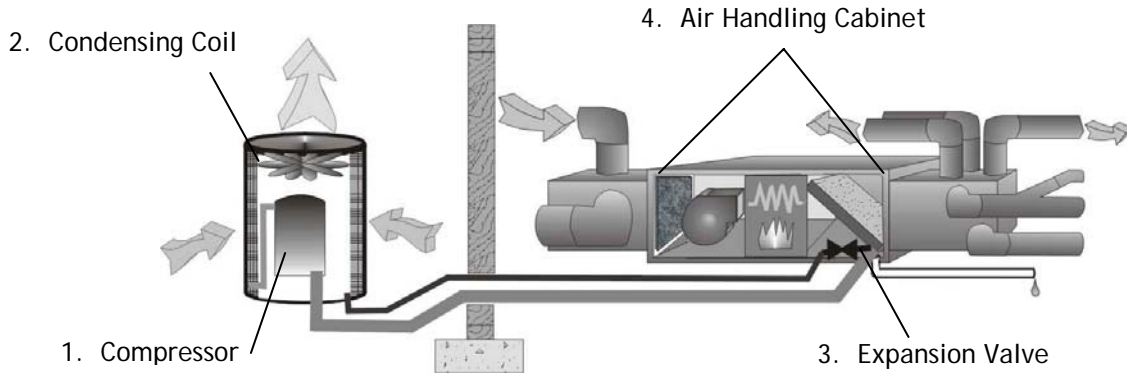

1. Cold, liquid refrigerant circulates through evaporator coils. Inside air is blown across the coils and is cooled. This warms and evaporates the refrigerant. The cooled air is blown through the ductwork. The refrigerant, now a gas, flows to the outdoor unit.
2. The compressor (in the outside unit) pressurizes the gaseous refrigerant. The refrigerant temperature rises, but remains a gas.
3. Fans in the outdoor unit blow air across the hot, pressurized gas in the condensing coil. The refrigerant cools and condenses into a liquid.
4. The pressurized liquid flows inside to the air handling unit. It passes through an expansion valve, where its temperature drops as it vaporizes. The refrigerant flows to the evaporator coil and the process starts over.

The exterior, air-cooled condensing unit should be kept free from plants and debris that might block the flow of air through the coil or damage the thin fins of the coil. Ideally, locate the condensing unit in the shade. However, do not block air flow to or from this unit with dense vegetation, fencing or overhead decking.

The SEER Rating

The cooling efficiency of a heat pump or an air conditioner is rated by the Seasonal Energy Efficiency Ratio (SEER), a ratio of the average amount of cooling provided during the cooling season to the amount of electricity used. Current national legislation mandates a minimum SEER 13 for most residential air conditioners. Pending federal policies may further increase minimum efficiencies. Some units can meet SEER 23 ratings. Packaged units have a minimum SEER of 13.

Builders should be aware that the SEER rating is a national average based on equipment performance in Virginia. Some equipment may not produce the listed SEER in actual operation in Louisiana's homes, particularly during the cooling season.

One of the main problems with HVAC systems has been the inability of some higher efficiency equipment to dehumidify homes adequately. If units are not providing sufficient dehumidification, the typical homeowner response is to lower the thermostat setting. Since every degree the thermostat

is lowered increases cooling bills 3 to 7%, systems that have nominally high efficiencies, but inadequate dehumidification, may suffer from higher than expected cooling bills.

In fact, poorly functioning "high" efficiency systems may actually cost more to operate than a well designed, moderate efficiency unit. Make certain that the contractor has used Manual J techniques to size the system so that the air conditioning system meets both sensible and latent (humidity) loads at the manufacturer's claimed efficiency.

Variable Speed Units

The minimum standard for air conditioners of SEER 13 provides for a reasonably efficient unit. However, higher efficiency air conditioners may be quite economical. In order to increase the overall operating efficiency of an air conditioner or heat pump, multi-speed and variable speed compressors have been developed. These units can operate at low or medium speeds when the outdoor temperatures are not extreme. They can achieve a SEER of 15 to 16.

The cost of variable speed units is generally about 30% higher than standard units. Advantages they offer over standard, single-speed blowers:

- They usually save energy.
- They are quieter, and because they operate fairly continuously, there is far less start-up noise (often the most noticeable sound in a standard unit).
- They dehumidify better; some units offer a special dehumidification cycle, which is triggered by a humidistat that senses when the humidity levels in the home are too high.

Proper Installation

Too often, high efficiency cooling and heating equipment is improperly installed, which can cause it to operate at substantially reduced efficiencies. A SEER 15 unit that is installed poorly with leaky ductwork may only deliver SEER 10 performance. Typical installation problems are:

- Improper charging of the system – the refrigerant of the cooling system does the bulk of the work, flowing back and forth between the inside coil and the outside coil, changing states, and undergoing expansion and compression. The HVAC contractor should use the manufacturer's installation procedures to charge the system properly. The correct charge cannot be ensured by pressure gauge measurements alone. In new construction, the refrigerant should be weighed in based on the length and size of the refrigerant lines and the HVAC system. Then, use either the supercharge temperature method or, for systems with certain types of expansion valves, the supercooling method to confirm that the charge is correct.
- Reduced air flow – if the system has poorly designed ductwork, constrictions in the air distribution system, clogged or more restrictive filters, or other impediments, the blower may not be able to transport adequate air over the indoor coils of the cooling system.
- Inadequate air flow to the outdoor unit – if the outdoor unit is located under an overhang or a deck, or within an enclosure such as fencing or bushes, air may not circulate freely between the unit and outdoor air. In such cases, the temperature of the air around the unit rises, thereby making it more difficult for the unit to cool the refrigerant. The efficiency of a unit surrounded by outdoor air that is 10 degrees warmer than the ambient outside temperature can reduce the efficiency of the unit by about 10%.

For all types of HVAC systems, the best way to ensure proper installation is to include a set of specifications with the plans that dictate the following:

- The system shall be sized for the load using Manual J or other approved methods.
- The refrigerant charge shall be calculated, weighed in, and confirmed using manufacturer's suggested procedures.
- Ductwork shall be sized using Manual D, or other approved method, and fully sealed.
- Make certain supply air has a pathway back to the return. Many homes rely on undercut interior doors to let air flow from the room to a central return. However, as discussed in Chapter 8, many rooms, especially those with multiple supply ducts, become pressurized when the HVAC operates. As a consequence, when several interior doors are closed, the main section of the home where the central return is located becomes negatively pressurized. Rooms with more than one supply duct and no return should be connected to the central section of the home with a transfer grille, which permits air flow between the two spaces.
- The system's operation shall be checked, balanced, and confirmed.

Heating Systems

Two types of heating systems are most common in new homes - furnaces, which burn natural gas, propane, fuel oil, or electricity, and electric heat pumps. Furnaces are generally installed along with central air conditioners. Heat pumps provide both heating and cooling, so separate units are not necessary. Some homes also use electric resistance heating. Resistance heating turns nearly all of the electricity used into heat. However, resistance heaters are only about 50% as efficient as heat pumps. Also, because of electrical losses in the power distribution grid, the resistance heater may use only about 30% of the energy of the original fuel source.

Heat Pump Equipment

Air-source heat pumps

The most common type of heat pump is the air-source heat pump, which serves as an air conditioner during the cooling season. In winter, it reverses the cycle and obtains heat from cool outside air. Most heat pumps operate at least twice as efficiently as conventional electric resistance heating systems. They have rated lifetimes of 15 years, compared to 20 years for most furnaces; however, many homeowners have well maintained equipment over 20 years old that continues to work effectively.

At outside temperatures of 30°F to 45°F, at a temperature known as the balance point, heat pumps can no longer meet the entire heating load of the home. Most systems use electric resistance coils called strip heaters to provide supplemental backup heat. Strip heaters, located in the air handling unit, are much more expensive to operate than the heat pump itself. They should not be oversized, as they can drive up the peak load requirements of the local electric utility.

A staged, heat pump thermostat used in concert with multistage strip heaters will minimize strip heat operation. Dual-fuel or piggyback systems heat the home with natural gas or propane when temperatures drop below the balance point.

Air-source heat pumps should have outdoor thermostats, which prevent operation of the strip heaters at temperatures above 38°F. The International Energy Conservation Code requires controls to prevent strip heater operation during weather when the heat pump alone can provide adequate

heating. In addition, tight ductwork is especially important in air-source heat pumps to prevent an uncomfortably low delivery temperature of supply air into the living areas.

Figure 7-4
Air Source Heat Pump

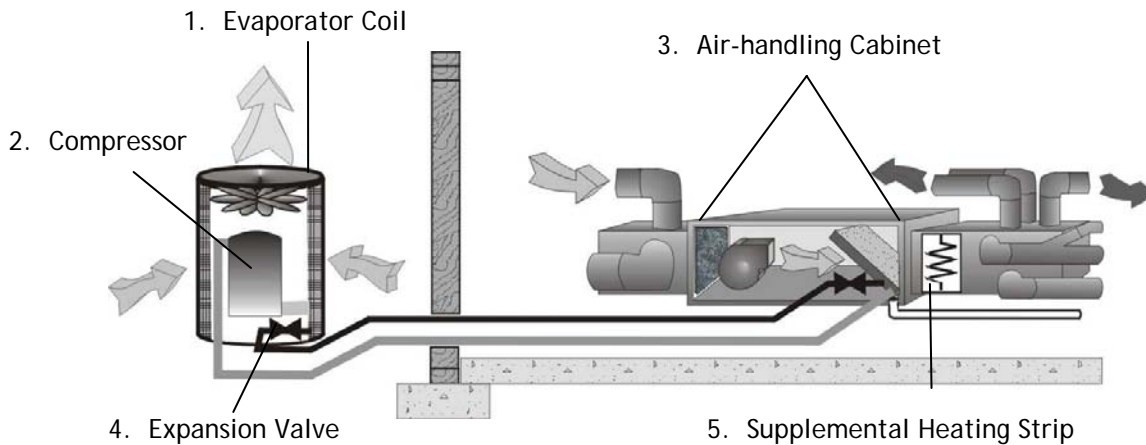

1. The outdoor coil, which serves as the evaporator coil in heat pump mode, uses outside air to boil the cold, liquid refrigerant.
2. The compressor pressurizes the refrigerant.
3. The hot, gaseous refrigerant enters the inside coil, which is serving as the condensing coil. Inside air passes over the coil and is heated. The refrigerant is cooled and condenses into a liquid.
4. The pressurized, liquid refrigerant flows outside to the expansion valve. The expansion valve reduces the pressure and further lowers the temperature of the refrigerant. This completes the cycle.
5. If the outdoor air is too cold for the heat pump to adequately heat the home, supplemental heating must be provided. In Louisiana, a gas-fired heater or electric resistance strip heater is normally used for supplemental heating.

Periodically in winter, the heat pump must switch to a defrost cycle, which melts any ice that may accumulate on the outside coil.

Geothermal heat pumps

Unlike an air-source heat pump with its outside coil and fan, a geothermal heat pump relies on fluid-filled pipes buried beneath the earth as a source of heating in winter and cooling in summer. In each season, the temperature of the earth is closer to the desired temperature of the home than outdoor air, so less energy is needed to maintain comfort. Eliminating the outside equipment means higher efficiency, less maintenance, greater equipment life, less noise, and no inconvenience of having to mow around that outdoor unit.

Geothermal heat pumps have SEER ratings above 15 and can save up to 40% on the heating and cooling costs of a standard air-source heat pump. Some geothermal products have greater dehumidification ability as well. Many units can also provide hot water at much greater efficiency than standard electric water heaters.

Types of closed loop designs for piping include:

- In deep well systems, a piping loop extends several hundred feet under ground.

- Shallow loops placed in long trenches, typically about 6-feet deep and several hundred feet long; coiling the piping into a "slinky" reduces the length requirements but a relatively large ground area is required.
- For homes located on private lakes, loops can be installed on the bottom, which decreases the installation costs or a plate type heat exchanger can be suspended vertically below the surface.

The buried piping in geothermal systems usually has a 25-year warranty. Most experts believe the piping will last longer, because it is made of a durable plastic with heat-sealed connections, and the circulating fluid has an anticorrosive additive.

The actual costs of geothermal heat pumps vary according to the difficulty of installing the ground loops as well as the size and features of the equipment. Because of their high installation cost, geothermal heat pumps may not be economical for homes with low heating and cooling needs. However, their lower operating costs, reduced maintenance requirements, and greater comfort may make them attractive to many homeowners. Proper installation of the geothermal loops is essential for high performance and the longevity of the system, so choose only qualified, experienced geothermal heat pump contractors.

Measures of efficiency for heat pumps

The heating efficiency of a heat pump is measured by its Heating Season Performance Factor (HSPF), which is the ratio of heat provided in Btu per hour to watts of electricity used. This factor considers the losses when the equipment starts up and stops, as well as the energy lost during the defrost cycle. The HSPF averages the performance of heating equipment for a typical winter in the United States, so the actual efficiency will vary in different climates.

Typical values for the HSPF are 7.7 for standard efficiency and 8.0 for high efficiency. Variable speed heat pumps have HSPF ratings as high as 9.0. Geothermal heat pumps are not rated by HSPF as yet; however, they are much more efficient than air-source heat pumps and work well at sub-zero temperatures. They are also quieter than conventional systems and include water heating capabilities. The ARI Directory of Air Conditioning Equipment lists the efficiencies of many different products.

Furnace Equipment

Furnaces burn fuels such as natural gas, propane, and fuel oil to produce heat and provide warm, comfortable indoor air during cold weather in winter. They come in a variety of efficiencies. The comparative economics between heat pumps and furnaces depend on the type of fuel burned, its price, the home's design, and the outdoor climate. Recent increases in energy prices have improved the economics of more efficient heating and cooling systems. However, at this point in time it is difficult to compare furnaces and heat pumps of various types due to long-term fuel price uncertainty.

Furnace operation

Fuel-fired furnaces require oxygen for combustion and extra air to vent exhaust gases. For many years, atmospheric or natural draft furnaces were the standard. These units draw in air from around them whether located in the house, crawlspace or attic. They have a single, unsealed exhaust stack to carry the hot exhaust gases out of the home. Older units used a continuously burning gas flame as a pilot light to ignite the fuel when the home's thermostat detected a need for heat.

Homes today are generally built much tighter, have central air conditioning, and a variety of exhaust fans including range hoods, bathroom exhaust fan, and clothes dryers. As discussed in Chapter 2 and in Chapter 8 on ductwork, operating exhaust fans and even closing interior doors can cause negative pressure in the area around the furnace, especially in tighter homes. If the negative pressure is sufficiently high, the furnace may backdraft, pulling the exhaust gases down the flue and into the home and creating potentially deadly levels of carbon monoxide.

Because negative pressures can occur in virtually any home, atmospheric furnaces should not be installed in the conditioned space. If located inside the conditioned area of a home, they must be installed in a sealed and insulated closet, as shown in Figure 7-5, with two sources of incoming combustion air - one entering near the floor and the other near the ceiling. The unit must include an exhaust vent that extends through the roof.

Figure 7-5
Sealed Mechanical Room Design for Non-direct Vent Furnace

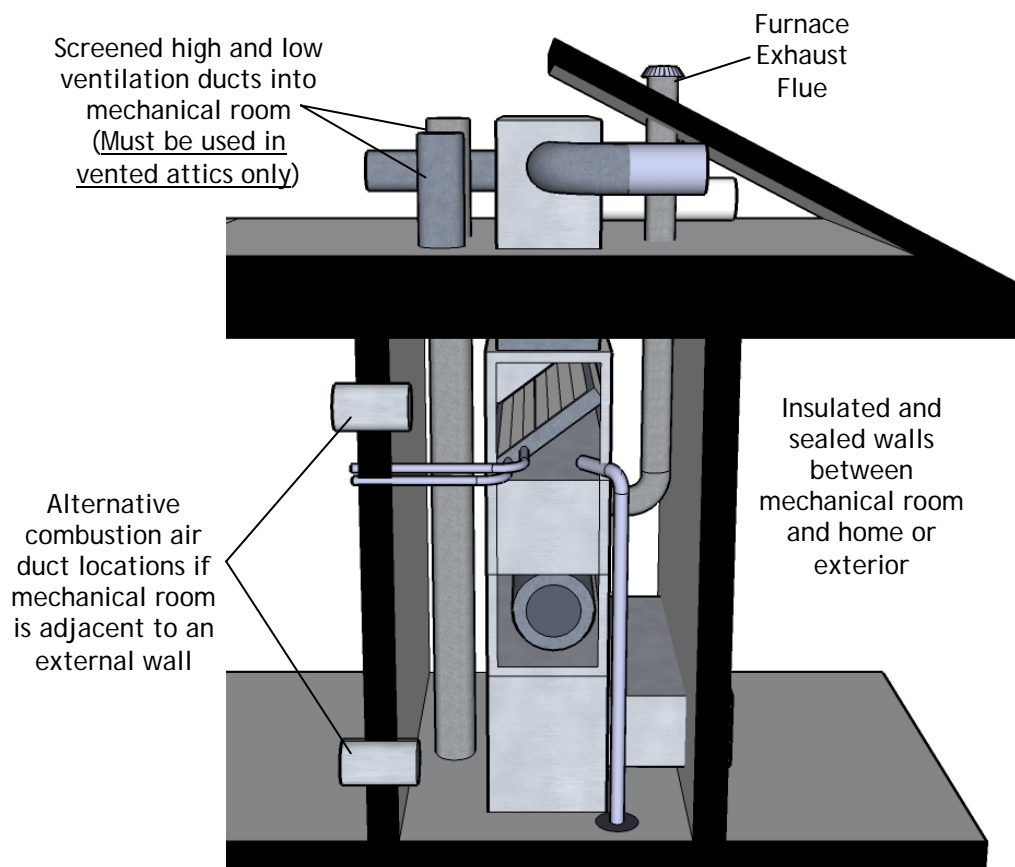

More modern furnaces, known as direct vent or uncoupled furnaces, have a duct that supplies combustion air from the outside directly to the burner and a sealed exhaust vent to the outside. Because their combustion system is totally isolated from the living space, these units can operate safely inside a home, when in proper working order. They are recommended unless the furnace is completely outside the conditioned area of the home.

Measures of efficiency for furnaces

The efficiency of a gas furnace is measured by the Annual Fuel Utilization Efficiency (AFUE), a rating which takes into consideration losses from pilot lights, start-up, and stopping. Unlike SEER and HSPF ratings, the AFUE does not consider the unit's electricity use for fans and blowers, which may exceed \$50 annually.

An AFUE rating of 78% means that for every \$1.00 worth of fuel used by the unit, \$0.78 worth of usable heat is produced. The remaining \$0.22 worth of energy is lost as waste heat exhausted up the flue.

Several years ago, the federal government mandated that furnaces have AFUE ratings of at least 78%. Old, atmospheric furnaces with pilot lights had AFUE ratings of only 50 to 60%. Manufacturers were able to meet the new standard by first replacing pilot lights with electronic ignition. Some of these units are able to operate at an AFUE of 78% and are being sold today in Louisiana.

Most manufacturers took the next steps of improving the heat exchanger inside the unit and installing a fan to force exhaust gases out of the flue. These furnaces are usually non-direct vent units because they do not have a sealed source of combustion air. They must be treated in the same manner as atmospheric furnaces, as described in the previous section. However, they are much less susceptible to backdrafting because of the fan for exhausting flue gases. Their AFUE ratings are typically 80% to 83%.

Models with efficiencies over 90% and up to 97%, commonly called condensing furnaces, contain secondary heat exchangers that actually cool flue gases until they partially condense. Heat losses up the flue are virtually eliminated. A drain line connected to the flue drains the condensate. One advantage of cooler exhaust gas is that you can use a plastic flue pipe that can be vented horizontally through a side wall. Metal flues, sometimes required by code, will quickly corrode when used with these high efficiency units. Make sure your local building official is aware of the need to install a plastic flue before ordering a condensing furnace.

There are a variety of condensing furnaces available. Some rely primarily on the secondary heat exchanger to increase efficiency, while others, such as the pulse furnace, have revamped the entire combustion process.

Because of the wide variety of condensing furnaces on the market, compare prices, warranties, and service. Also, compare the economics carefully with those of moderate efficiency units. Condensing units may have longer paybacks than expected in energy efficient homes due to reduced heating loads.

Integrated Space and Water Heating

An integrated space heating and domestic water heating unit provides a single, multipurpose system. The American Society of Heating, Refrigeration, and Air Conditioning Engineers (ASHRAE) has developed standards by which to evaluate such systems, as well as methods of measuring the efficiency of integrated systems with either space heating or water heating as their primary purpose.

Figure 7-6
Integrated Space and Water Heating System

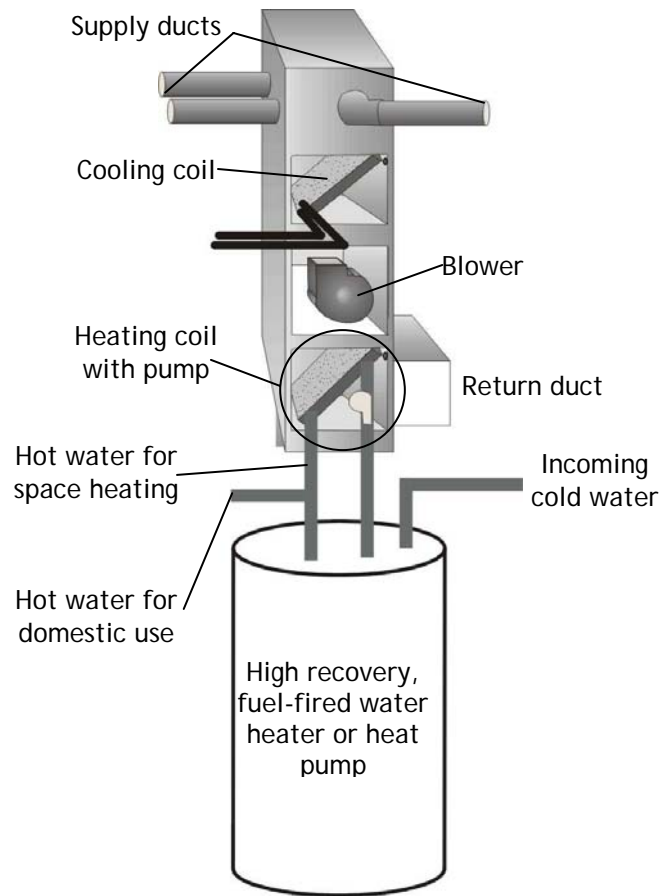

Gas-fired integrated systems

One type of integrated space and water heater system uses a quick recovery, high efficiency gas water heater to provide 140°F water that provides space heating and hot water. Heating needs are met by pumping hot water from the water heater to a heating duct coil in the air handling unit.

Household air passing through ductwork connected to this coil is heated to between 110°F and 120°F. The water, cooled to about 120°F by the air, returns from the heating coil to the integrated water heater for reheating. The air handler can also incorporate a cooling coil for air conditioning. The economics of these units can be quite favorable; however, it is often difficult to obtain an objective comparison between integrated systems and more conventional space and water heating equipment.

Some advantages of integrated systems are:

- They can save floor space, as some air handling units mount to the wall or within the wall cavity above the water heater tank.
- They may have lower installed costs - only one gas hookup and a single flue are required.
- They often have a more efficient water heater than standard homes.

Another integrated approach uses a central boiler to provide space and water heating. Typically, the boiler can provide hot water even in non-heating seasons more efficiently than standard water heaters. However, the greater initial cost of this type of system may limit its use to families with high hot water demands.

Electric integrated systems

There are several products that use central heat pumps for water heating, space heating and air conditioning. These integrated units are available in both air-source and geothermal models.

Make sure the unit is not substantially more expensive than a separate energy efficient heat pump and electric water heater. Units within \$1,500 may provide favorable economic returns. The SEER of the unit should exceed 13.0. To be a viable choice, any type of integrated system should:

- Have a proven track record in the field.
- Cost about the same, if not less, than comparable heating and hot water systems of approximately the same efficiencies.
- Provide at least a five-year warranty.
- Be properly sized for both the heating and hot water load.

Wood Heating

Wood can be a thrifty alternative to conventional heating sources. However, if the homeowner must purchase wood fuel, the savings will diminish. Wood heating also requires work, and a fire-safe installation is essential.

Although there are wood-burning furnaces designed for homes, most homeowners interested in wood heating use a fireplace or wood heater — either freestanding stove or fireplace insert. Fireplaces and wood heaters are primarily space heaters. They radiate heat to people and objects close by and, to a lesser degree, heat the surrounding air.

Like other fuel-burning equipment, fireplaces and wood heaters need air for combustion and must vent exhaust products to the outside. In standard construction, air infiltration provides the necessary combustion air. However, in energy efficient homes, the sources of air infiltration are greatly reduced so special measures to supply outside combustion air must be provided.

An energy efficient fireplace must have a direct vent that brings air from outside the home to the firebox. The vent should be designed so that it remains clear of ashes, wood, and other materials when a fire is burning. It should be located toward the front of the firebox and have a damper or lid that prevents infiltration when the fireplace is not in use.

In addition to an outside source of combustion air, a fireplace should have a tight-fitting flue damper and glass doors to reduce air leakage further. The flue damper should be opened before lighting a fire and closed after combustion is complete.

Figure 7-7
Efficient Wood Heater Design

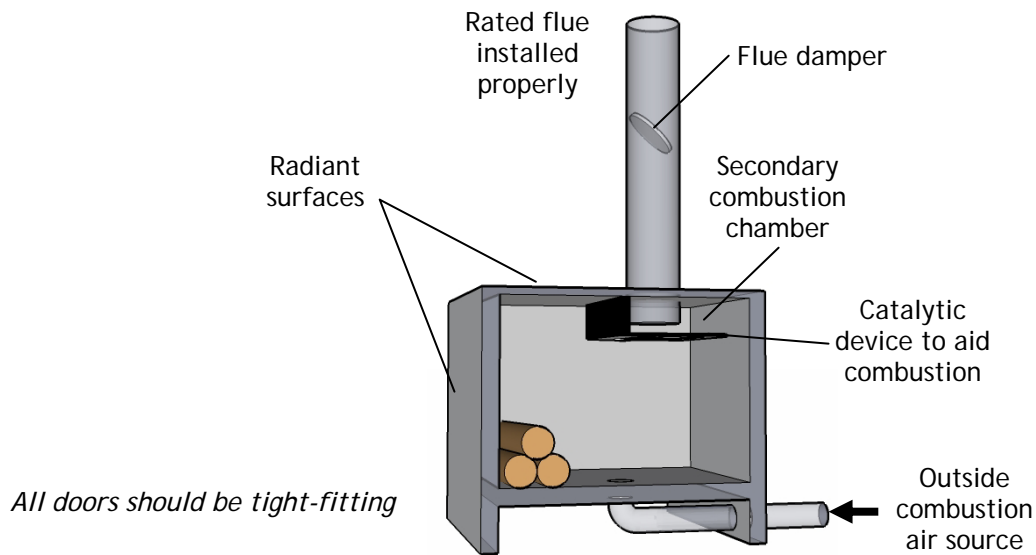

Some fireplace designs provide a means of heating room air by circulating it around the firebox where it is heated and then passed back into the house. These systems are more efficient than standard fireplaces.

Homeowners serious about using wood as a heat source should choose a high efficiency wood heater, such as an airtight wood stove. As with fireplaces, wood heaters in energy efficient homes should have an outside source of combustion air. In fact, even standard houses may not have adequate infiltration levels to maintain proper combustion and venting for a wood heater.

To ensure safety, select a wood heater designed to use outside combustion air. These units are required by code in manufactured housing and are usually sold by businesses supplying wood heaters and fireplaces. The wood heater should also be properly sized for the home. Many energy efficient homes have small heating loads, so large or even moderate-sized wood heaters may produce too much heat.

Figure 7-8
Direct Vent Heaters

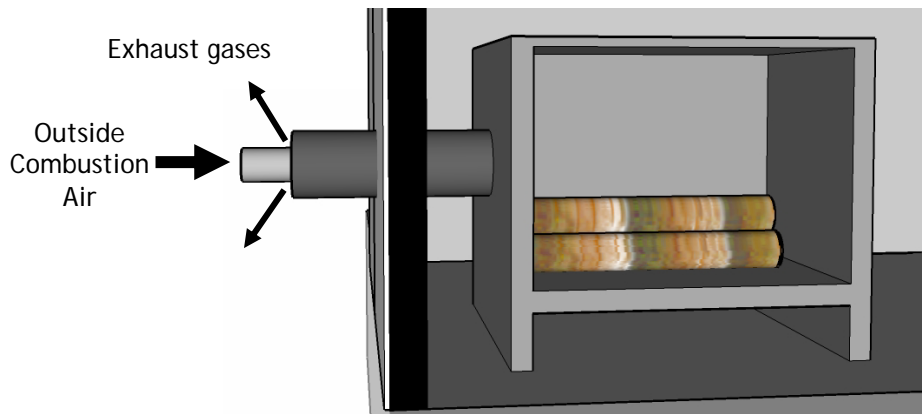

Unvented Fuel-Fired Heaters

Unvented heaters that burn natural gas, propane, kerosene, or other fuels are strongly discouraged. While these devices usually operate without problems, the consequences of a malfunction are life-threatening; they can exhaust carbon monoxide, sulfur oxides, and nitrogen oxides directly into household air. They also can create serious moisture problems inside the home.

Most devices come equipped with alarms designed to detect air quality problems. However, many experts question putting a family at any risk of carbon monoxide poisoning - they see no rationale for bringing these units into a home. There are a wide variety of efficient, vented space heaters available. Examples of unvented units to avoid include:

- Flueless gas fireplaces - use sealed combustion, direct vent units instead
- Room space heaters - choose forced-draft, direct-vent models instead

Ventilation and Indoor Air Quality

All houses need ventilation to remove stale interior air and excessive moisture. There has been considerable concern recently about how much ventilation is required to maintain the quality of air in homes. While there is substantial disagreement on the severity of indoor air quality problems, most experts agree that the solution is not to build an inefficient, “leaky” home. Because make-up air is brought in at outside temperatures, it often requires more energy to condition the home. However, the ventilation may reduce energy use by removing excess humidity. With Louisiana’s humid environment, though, the outside air will typically be more humid than the inside air.

Research studies show that standard houses are almost as likely to have indoor air quality problems as energy efficient ones. Most building researchers believe that no house is so leaky that the occupants can be relieved of concern about indoor air quality. They recommend mechanical ventilation systems for all houses.

The amount of ventilation required depends on the number of occupants and their lifestyle, as well as the design of the home. The ASHRAE standard, “Ventilation for Acceptable Indoor Air Quality” (ASHRAE 62) recommends that houses have 0.35 natural air changes per hour (nach) or 15 cubic feet per minute of ventilation per occupant.

Older, drafty houses can have infiltration rates of 1.0 to 2.5 nach. Standard homes built today are tighter and usually have rates of from 0.5 to 1.0 nach. New, energy efficient homes often have less than 0.35 nach.

Infiltration is not a successful means of ventilation because it is not reliable and the quantity of incoming air is not controllable. Air leaks are unpredictable, and infiltration rates for all houses vary. For example, air leakage is greater during cold, windy periods than during muggy, hot weather. Thus, pollutants may accumulate during periods of calm weather even in drafty houses. These homes will also have many days when excessive infiltration provides too much ventilation, causing discomfort, high energy bills, and possible deterioration of the building envelope.

Concerns about indoor air quality are leading more and more homeowners to install controlled ventilation systems that provide a reliable source of fresh air. The simplest approach is to provide spot ventilation of bathrooms and kitchens to control moisture. Nearly all exhaust fans in standard construction are ineffective — a prime contributor to moisture problems in Louisiana homes. Builders should select quality fans with low noise ratings.

Figure 7-9
Ventilation with Spot Fans

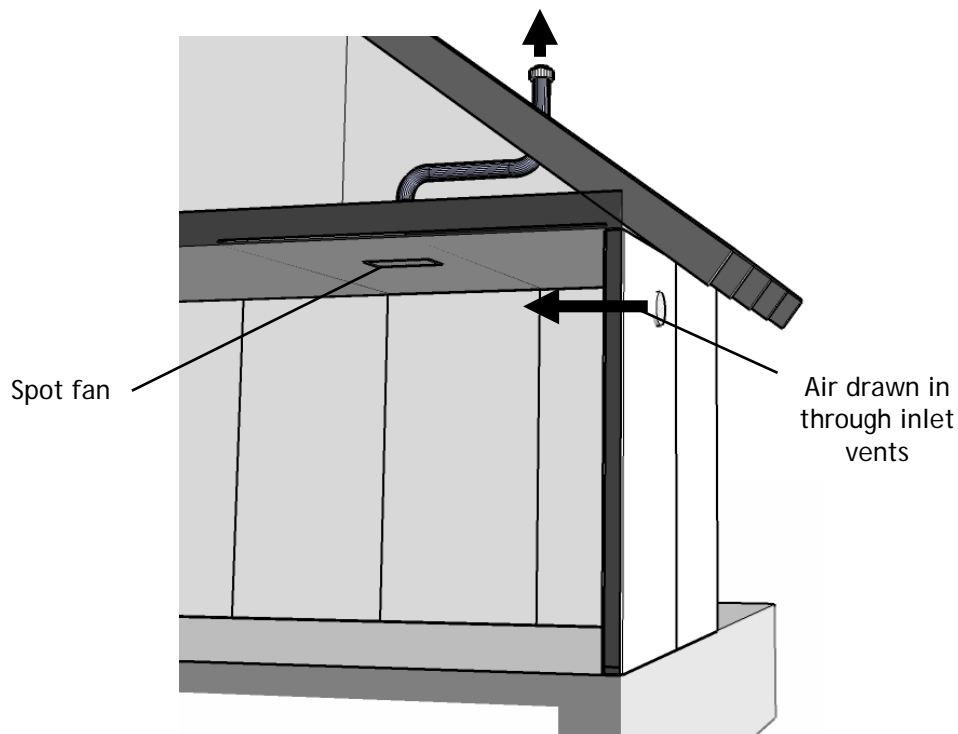

General guidelines call for providing a minimum of 50 cubic feet per minute (cfm) of air flow for baths and 100 cfm for kitchens. Manufacturers should supply the cfm rating for any exhaust fan.

The cfm rating typically assumes the fan is working against an air pressure resistance of 0.1 inch of water - the resistance provided by about 15 feet of straight, smooth metal duct. In practice, most fans are vented with flexible duct that provides much more resistance. Many ventilation experts suggest choosing a fan based on a resistance of 0.30 inches of water.

While larger fans cost more, they are usually better constructed and therefore last longer and run quieter. The level of noise for a fan is rated by sones. Choose a fan with a sone rating of 1.5 or less. Top quality models are often below 0.5 sones.

Many ceiling- or wall-mounted exhaust fans can be adapted as “in-line” blowers located outside of the living area, such as in an attic or basement. Manufacturers also offer in-line fans to vent a single bath or kitchen, or multiple rooms. Distancing the in-line fan from the living area lessens noise problems.

Bath and kitchen exhaust fans should vent to the outside - not just into an attic or crawlspace. Avoid side-vented stove units whose exhaust fans pull 400 to 700 cfm from the house. Unless some form of make-up air is supplied, these units can create high levels of negative pressure.

Always test a home for pressure imbalance problems when fans are operating. In tighter homes, a single bathroom exhaust fans may backdraft fireplaces or combustion appliances. If pressure problems exist, the home should have a source of make-up air, which is described in the next section.

While improving spot ventilation will certainly help control moisture problems, it may not provide adequate ventilation for the entire home. A whole house ventilation system can exhaust air from the kitchen, all baths, and perhaps the living area or bedrooms.

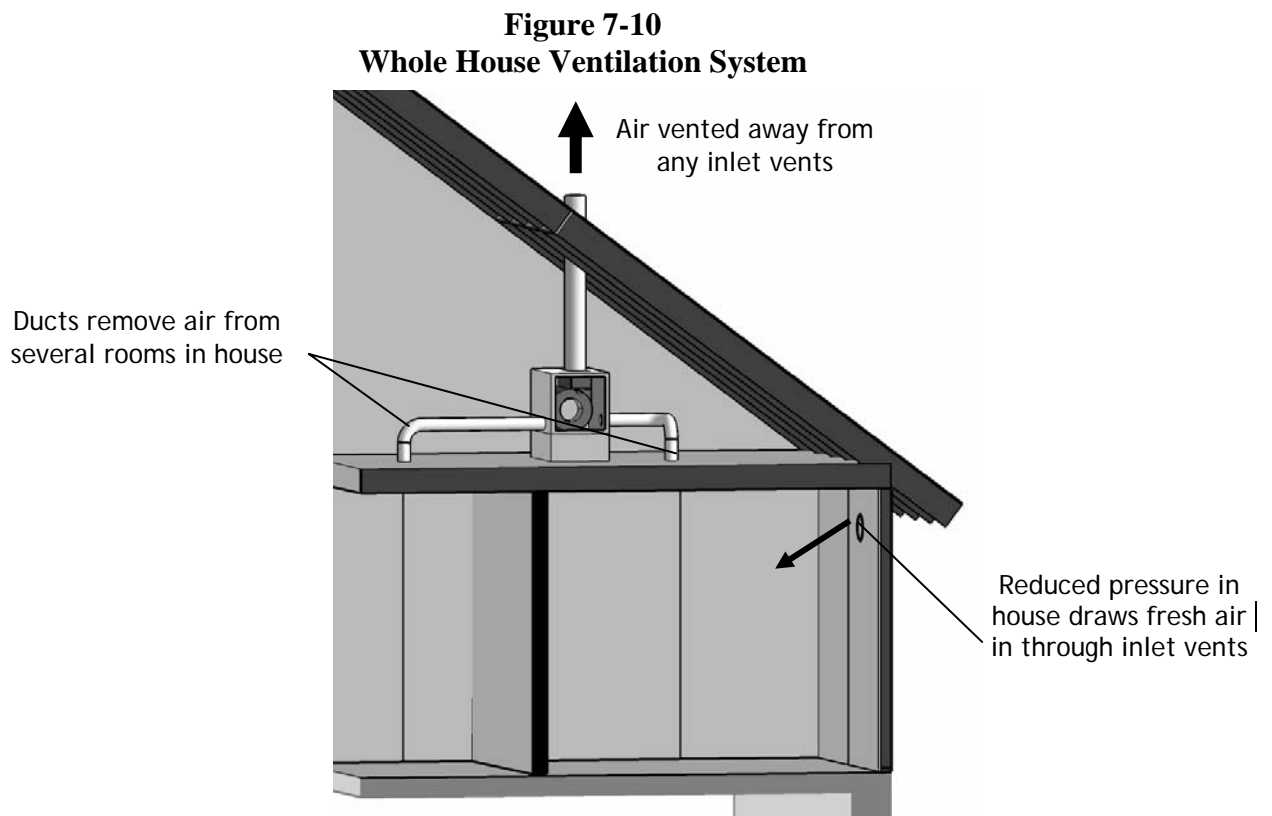

Whole house ventilation systems usually have large single fans located in the attic or basement. Ductwork extends to rooms requiring ventilation. These units typically have two-speed motors. The low speed setting gives continuous ventilation – usually 10 cfm per person or 0.35 ach. The high speed setting can quickly vent moisture or odors.

Supplying Outside Make-up Air

From air leaks

The air vented from the home by exhaust fans must be replaced by outside air. Air leaks can provide the make-up air, but this does not guarantee fresh air. It is far better to provide a controlled mechanism for make-up air as an integral part of the house design. Relying on air leaks requires no extra equipment; however, the occupant has little control over the air entry points. Plus, many of the air leaks come from undesirable locations, such as crawlspaces or attics. If the home is too airtight, the ventilation fans will not be able to pull in enough outside air to balance the air being exhausted. This may threaten air quality by pulling exhaust gases from flues and chimneys back into the home. The homeowner can alleviate the pressure problems by opening windows slightly though this may pose a home security risk.

From inlet vents

Providing fresh outside air through inlet vents is another option. These vents can often be purchased from energy specialty outlets by mail order. They are usually located in exterior walls. The amount of air they allow into the home can be controlled manually or by humidity sensors.

Locate inlet vents where they will not create uncomfortable drafts. They are often installed in bedroom closets with louvered doors or high on exterior walls. Ideally, they should be filtered and located as far as possible from all exhaust vents.

Via ducted make-up air

Outside air can also be drawn into and distributed through the home via the ducts for a forced-air heating and cooling system. This type of system usually has an automatically controlled outside air damper in the return duct system. The blower for the ventilation system is either the air handler for the heating and cooling system or a smaller unit that is strictly designed to provide ventilation air.

Dehumidification Ventilation Systems

Louisiana homes are often more humid than desired. A combined ventilation-dehumidifier system can bring in fresh, outdoor air, remove its moisture, and supply it to the home. These systems can also filter incoming air. Because these systems require an additional mechanical device - a dehumidifier installed on the air supply duct - they should be designed for the specific needs of the home.

Heat Recovery Ventilators

Air-to-air heat exchangers, or heat recovery ventilators (HRV — described in Figure 7-11), typically have separate duct systems that draw in outside air for ventilation and distribute fresh air throughout the house. In winter, heat from stale room air is “exchanged” to the cooler incoming air. In summer, the hot outdoor air is cooled and may be partially dehumidified by the cooler exhaust air. Some models, called enthalpy heat exchangers, can also recapture cooling energy in summer by exchanging moisture between exhaust and supply air.

While energy experts have questioned the value of the heat saved in Louisiana homes for the cost for an HRV, recent studies on enthalpy units indicate their dehumidification benefit in summer offers an advantage over ventilation-only systems. The value of any heat recovery ventilation system should not be determined solely on the cost of recovered energy. The improved quality of the indoor environment must be considered as well.

Sample Ventilation Plans

Design 1: Upgraded Spot Ventilation

This relatively simple and inexpensive whole house ventilation system integrates spot ventilation using bathroom and kitchen exhaust fans with an upgraded exhaust fan (usually 100 to 150 cfm) in a centrally located bathroom. When the fan operates, outside air is drawn through inlets in closets with louvered doors. The fan is controlled by a timer set to provide ventilation at regular intervals. Interior doors are undercut to allow air flow to the central exhaust fan. The fan should be a long life, high-quality unit that operates quietly. In addition to the automatic ventilation provided by this system, occupants can turn on all exhaust fans manually as needed.

Design 2: Whole House Ventilation System

Whole house ventilation systems use a centralized, two-speed exhaust fan to draw air from the kitchen, bath, laundry, and living area. The blower is controlled by a timer. The system should provide approximately 0.35 ach on low speed and 1.0 ach on high speed. Outside air is supplied by a separate dampered duct connected to the return air system. When the exhaust fan operates, the outside air damper opens and allows air to be drawn into the house through the forced-air ductwork.

Design 3: Heat Recovery Ventilation System

HRV systems draw fresh outside air through ducts into the heat exchange equipment and recaptures heating or cooling energy from stale room air as it is being exhausted. Some systems, called enthalpy heat exchangers, also dry incoming humid air in summer - a particular benefit in the Southeast. Fresh air flows into the house via a separate duct system, which should be sealed as tightly as the HVAC ductwork. Exhaust room air can either be ducted to the exchanger from several rooms or a single central source.

Figure 7-11
Heat Recovery Ventilation (HRV) System

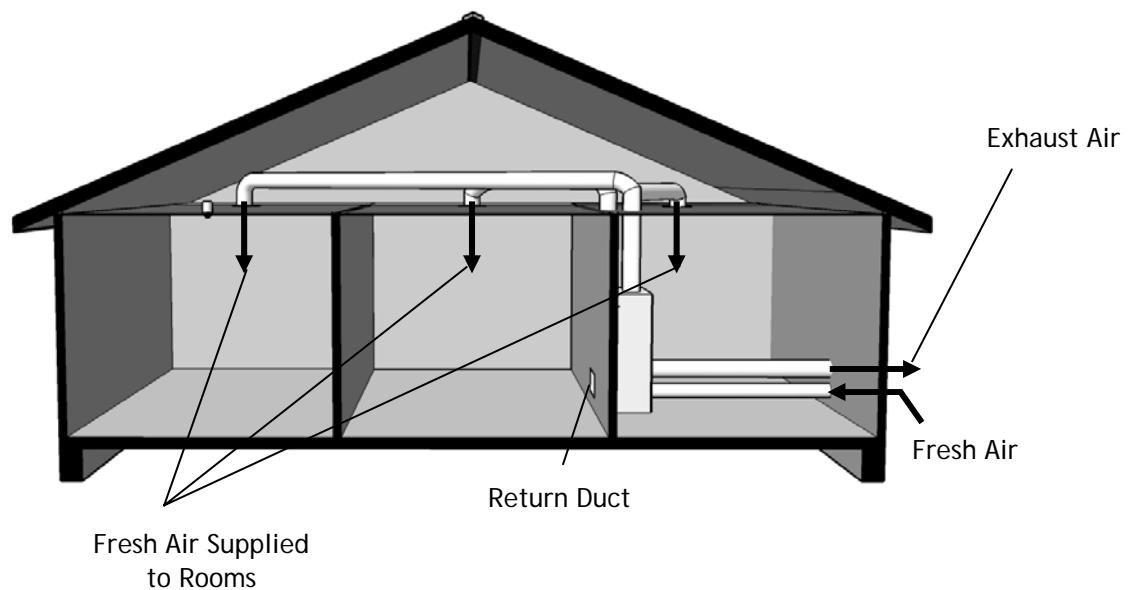

Overall HVAC Recommendations

Heating, ventilation, and air conditioning are very important components of a healthy, comfortable, and efficient house. Be sure to have the HVAC contractor size all HVAC equipment properly. Also, ensure that the house receives proper ventilation. Using leaks to provide fresh air can be a problem, because the air could be pulled from a polluted source. Ensure that all inlet vents are located in an area that will remain free from pollutants like car exhaust.

Notes:

Chapter 8

Duct Design and Sealing

Duct Materials

The three most common types of duct material used in home construction are *metal*, *rigid fiberglass duct board*, and *flex-duct*. Both metal and fiberglass duct board are rigid and installed in pieces, while flex-duct comes in long sections.

Flex-duct is usually installed in a single, continuous piece between the register and plenum box or plenum box and air handler. Be careful not to tear the soft lining material. The flex-duct must also not be pinched or constricted. Long flex-duct runs can restrict air flow, so they must be installed carefully. Flex-duct takeoffs, while often airtight in appearance, can have substantial leakage and should be sealed with mastic. Always select duct insulation with a shiny, metal foil exterior covering to reduce radiant heat gain and to act as a vapor barrier.

Round and rectangular metal duct must be sealed with mastic and insulated during installation. It is important to seal the seams and joints first, because the insulation does not stop air leaks.

Metal ducts often use fiberglass insulation having an attached metal foil vapor barrier. The duct insulation should be at least R-6, and the vapor barrier should be installed to the outside of the insulation - facing away from the duct. The seams in the insulation are usually stapled together around the duct and then taped. Duct insulation in homes at least two-years old provides visible clues about duct leakage – if the insulation is removed, lines of dirt in the fiberglass often show where air leakage has occurred. Sometimes, rectangular metal duct used for plenums and larger trunk duct runs is insulated internally with duct liner, a high density material that should be at least 1-inch thick. Many homeowners have concerns about the long term effects of the duct liner exposed to the air flowing through the system. They prefer to insulate the outside of the ductwork, rather than the inside. Internally insulated metal ducts cannot be cleaned as easily as externally insulated ducts. For acoustical dampening in transfer ducts (from room to room or hall) the internal lining is preferred.

Figure 8-1
Types of Ductwork

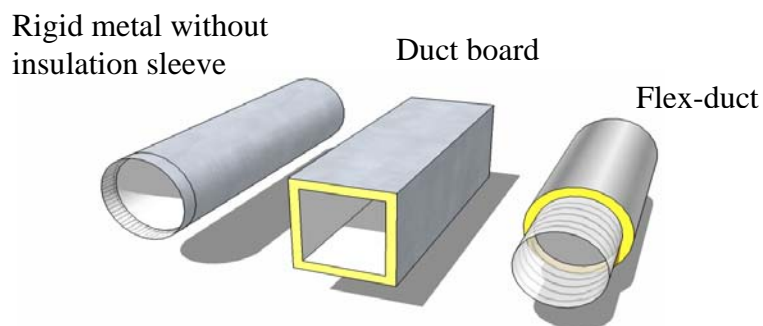

The Problem of Duct Leakage

Studies conducted throughout the country have found that poorly sealed ductwork is often the most prevalent yet easily solvable problem in new construction. Duct leakage contributes 10% to 30% of heating and cooling loads in many homes. In addition, duct leakage can decrease comfort and endanger health and safety.

Locating ducts in the conditioned space eliminates many problems with leakage. They are installed in vertical *chases* or *horizontal furred areas* (framed duct passageways situated below the ceiling). To be effective they must be completely sealed from unconditioned spaces.

Duct insulation does not provide an airtight seal. The heating and cooling contractor should use proper materials when sealing ductwork - in particular, duct sealing mastic with embedded reinforcing mesh tape. To ensure ducts are tight, a home energy rater will conduct a duct leakage test, which is necessary to qualify for possible tax credits.

The International Residential Code requires that HVAC contractors use mastic and mesh tape to seal leaks. This provision reflects the universal recognition that duct sealing is not only a cost effective energy efficiency measure, but it also improves comfort and, more importantly, makes our homes healthier places in which to live. Chapter 2 explains some of the health risks of leaky ductwork in detail.

Duct Leaks and Air Leakage

Forced-air heating and cooling systems should be *balanced* - the amount of air delivered through the supply ducts should be equal to that drawn through the return ducts. If the two volumes of air are unequal, the pressure inside the house can be affected. Pressure imbalances increase air leakage into and out of the home increasing air conditioning run-time to condition the infiltrated air. Pressure imbalances can also create air quality hazards in homes including:

- Pulling pollutants into the air handling system via return leaks.
- Draws in dust, mold, and humidity from the crawlspace.
- Potential back drafting of combustion appliances such as fireplaces, wood stoves and gas burners.
- Homes with central (non ducted) returns can have pressure imbalances when the interior doors to individual rooms or suites are closed:
 - The rooms having supply registers and no returns become pressurized, while the areas with centralized returns become depressurized (negative pressure relative to other areas of the house).
 - If the returns are open to rooms with fireplaces or combustion appliances (gas water heaters, for instance), these spaces can become sufficiently depressurized to draw combustion products, including carbon monoxide, into the air stream.

Typical causes of and concerns about pressure imbalances are addressed more fully in Chapter 2.

Figure 8-2 shows the impact of return and supply leaks on HVAC equipment efficiency when the makeup air is drawn from a hot attic. For example, a HVAC system having 15% return leakage in a moderately hot attic (125°F) can suffer a 50% drop in efficiency - from SEER 10 to SEER 6. The

SEER (Seasonal Energy Efficiency Ratio) measures the number of Btu's per hour of cooling each watt of electricity provides.

Figure 8-2
Efficiency Losses Due to Attic Return Leaks
(15% Supply Leaks)

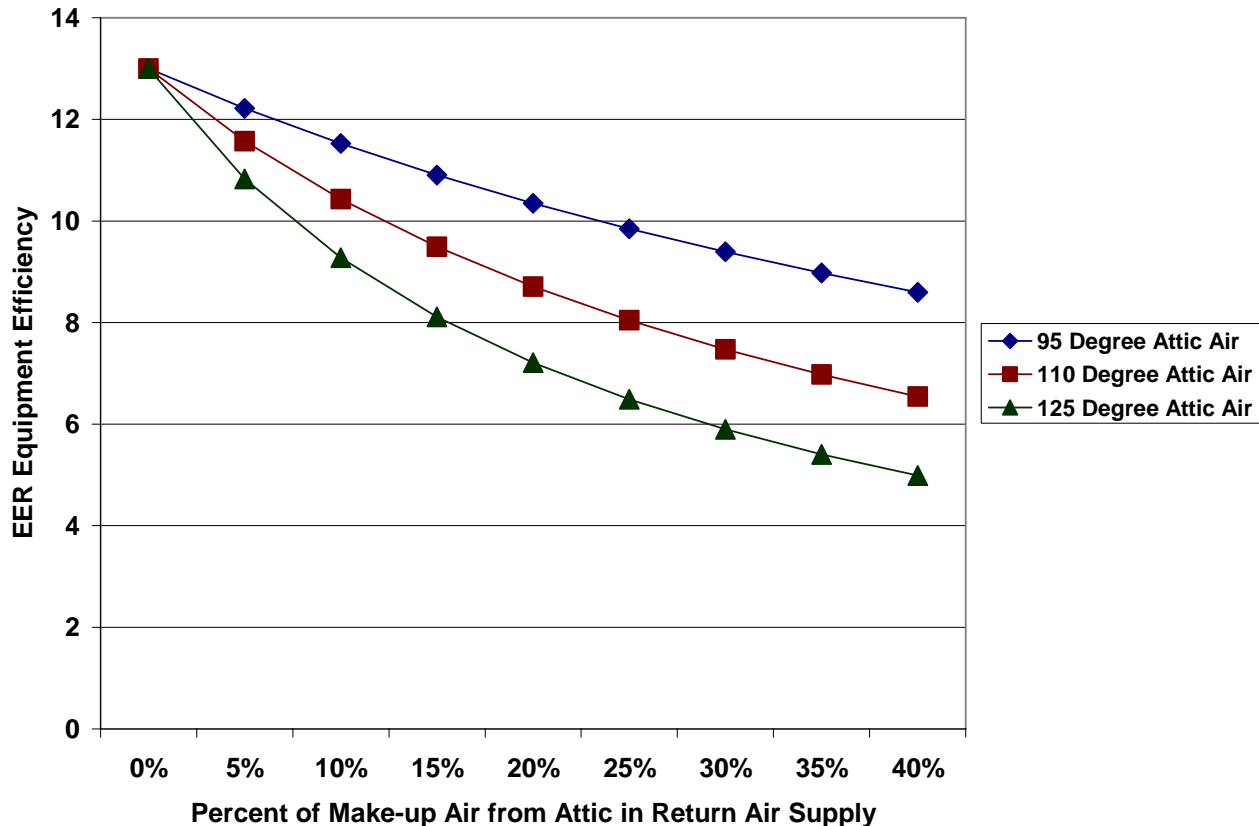

When HVAC supply ducts leak air to the outside, the return side of the system still requires the full amount of air back. In a home with 15% supply leaks, if 100% of the replacement air comes from the attic at 125 degrees, the efficiency of the system will drop from SEER 13 to about SEER 8.0, a 40% reduction in efficiency. Note that duct leakage of only 5% results in efficiency losses of 5% to 15%.

Leaky ducts can, therefore, be a significant cause for higher utility bills. They can also lower supply air temperatures in winter and increase them in summer, which may pose major comfort problems for the occupants.

Sealing Air Distribution Systems

Duct leakage should be minimized. Many duct seams and joints are poorly sealed with ineffective materials such as cloth “duct tape,” unrated aluminum tape, or similar products with low quality adhesives not designed to provide an airtight seal over the life of the home. Use only the following products and techniques for sealing the components of the air distribution system:

- Nontoxic duct sealing mastic (UL labeled 181A or B) with fiberglass mesh tape is highly preferred and provides a lifetime seal. It may add 1 to 2% to the cost of a system.

- Aluminum tape with a UL-181 A or B rating or "mastic" tapes with improved adhesives.
 - The duct surface must be clean of oil and dirt, and the tape must fully adhere to the duct with no wrinkles.
 - A squeegee must be used to remove air bubbles from beneath the taped surface.
 - Costs only slightly more than "silver tape," which has an inferior adhesive.
- High quality caulking or foam sealant at register boots.

Proper sealing and insulation of the ductwork in unconditioned areas requires careful attention to detail and extra time on the part of the HVAC contractor. The cost of this extra time is well worth the substantial savings on energy costs, improved comfort, and better air quality that a properly designed, constructed, and sealed duct system offers.

Figure 8-3
Sealing Flex-duct Collar with Mastic

Attach flex-duct to take-off collar with strap.

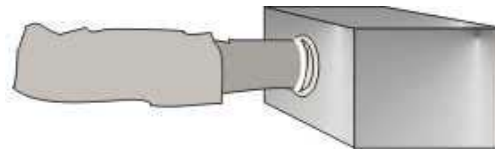

Apply mastic to seal flex-duct to collar and collar to plenum.

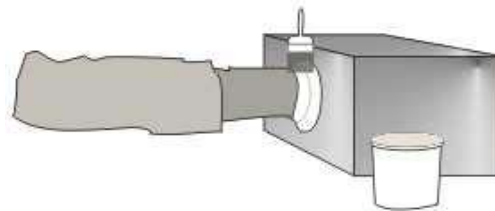

Pull insulation and outer liner over sealed take-off; strap outer liner in place

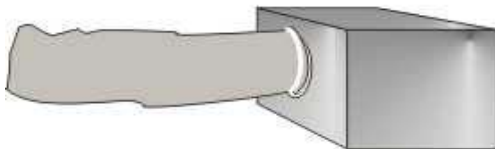

The easiest answer to the question of where to seal air distribution systems is “everywhere.” A list of the key locations is as follows:

High Priority Leaks

- Disconnected components, including takeoffs that are not fully inserted, ducts that have been dislodged, tears in flex-duct, and strained connections between ductwork (visible where ducts are bent without a metal elbow).
- All of the seams in the air handling unit, the supply and return plenums, and rectangular ductwork - look particularly underneath components and in any other tight areas. Also, seal the holes for the refrigerant, thermostat, and condensate lines with non-hardening putty. Use tape rather than mastic to seal the seams in the panels of the air handling unit so they can be removed for servicing. After completing service and maintenance work, such as filter changing, make sure the seams are re-taped.
- The return takeoffs, elbows, boots, and other connections. If the return is built into a wall, all connections and seams must be sealed carefully.
- The takeoffs from the main supply plenum and branch lines.
- Any framing in the building used as ductwork, such as a “panned” joist in which sheet metal nailed to floor joists provides a space for conditioned air to flow. It is preferable to avoid using framing cavities as a part of the duct system.
- Between the branch ductwork and the boot, the boot and the register, the seams of any elbows, and other potential leaks in this area.

Low Priority Leaks

- Longitudinal seams in round metal ductwork.

Figure 8-4
Disconnected Ducts Are High Priorities

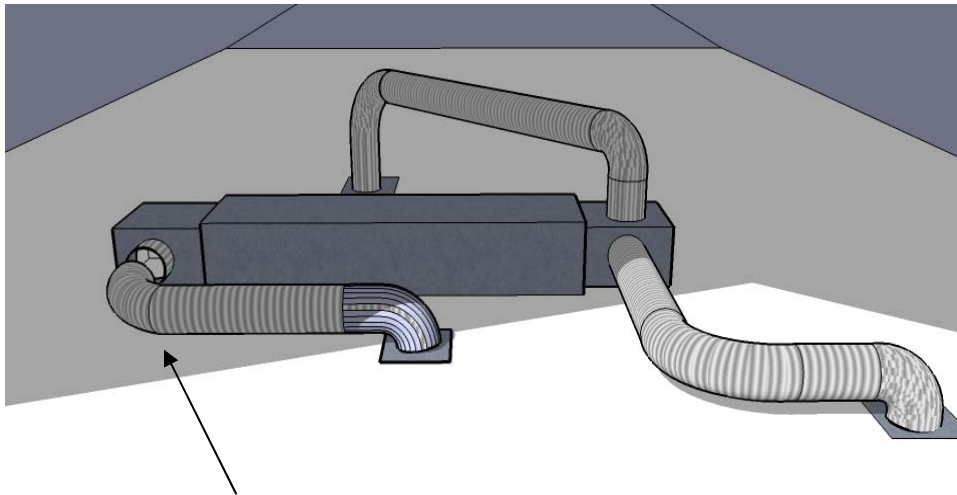

Disconnected duct. Also, regardless of the type of duct material, in order to maintain designed air flows to each register no bends greater than 45 degrees should ever be made in the duct run.

Ducts can become disconnected during initial installation, maintenance, or even normal operation. They should be checked periodically for problems.

Testing for Duct Leakage

The best method to ensure airtight ducts is to perform a pressure test on the entire duct system, including all boot connections, duct runs, plenums, and the air handler cabinet. Much like a pressure test required for plumbing, ductwork can be tested during construction so that problems can be more easily corrected.

In most test procedures, a technician temporarily seals the ducts by taping over the supply registers and return grille(s). Then, the ducts are pressurized to a low pressure, usually 25 Pascals, using a duct testing fan. This pressure is comparable to the average pressure the ducts experience when the air handler operates.

While ducts are pressurized, the technician can read the total duct leakage of the HVAC system. Some energy efficiency programs require that the cubic feet per minute of duct leakage measured at a 25 Pascal pressure (CFM25) be less than 3% of the floor area of the house. For example, a 2,000 square-foot house should have less than 60 (2,000 x 0.03) CFM25 of duct leakage.

Another test is to use a blower door (described in Chapter 3) and a duct testing fan together to measure duct leakage after construction is complete. This procedure gives the most accurate measurement of duct leakage to the outside of the home. A duct leakage test can usually be done in about one hour for an average-sized home.

Figure 8-5
Duct Test on Return Grille

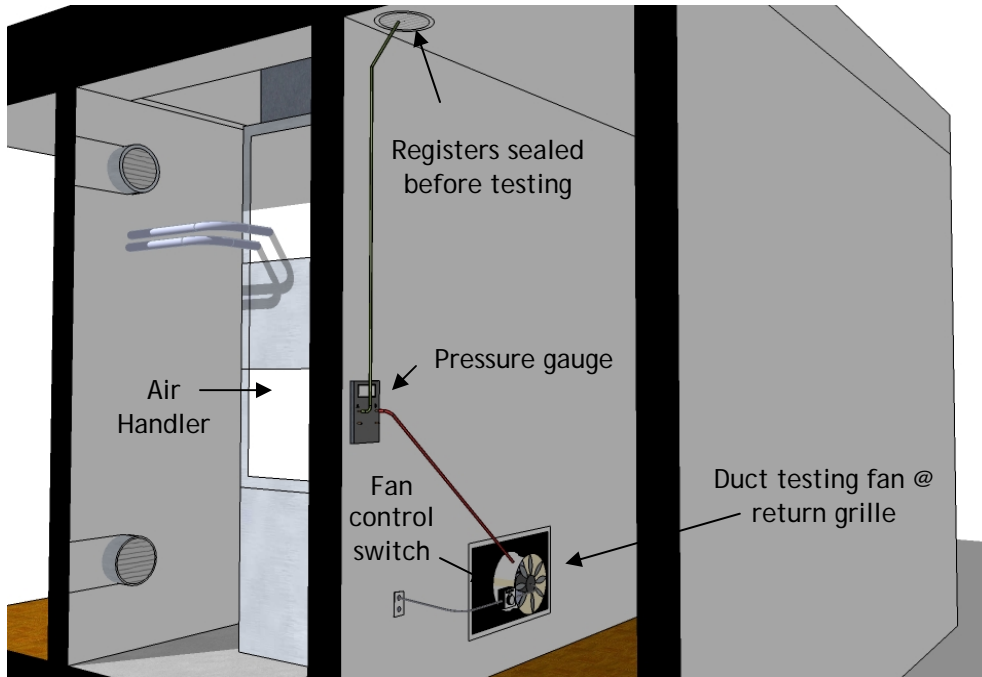

Figure 8-6
Duct Leaks in Inside Spaces

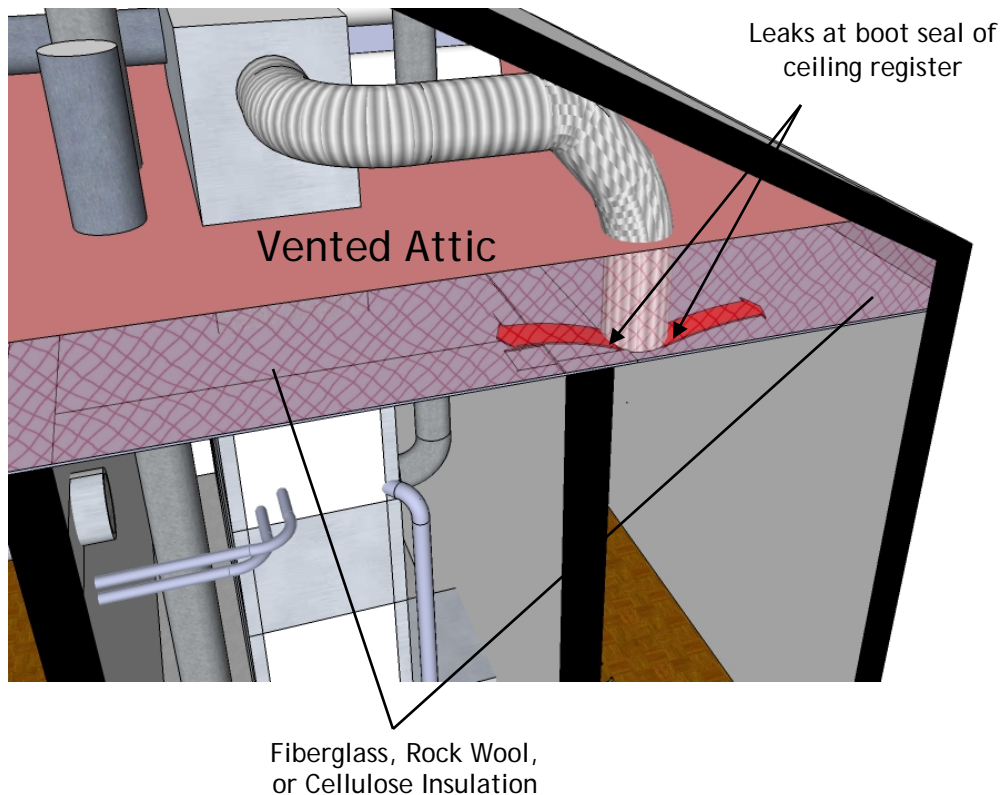
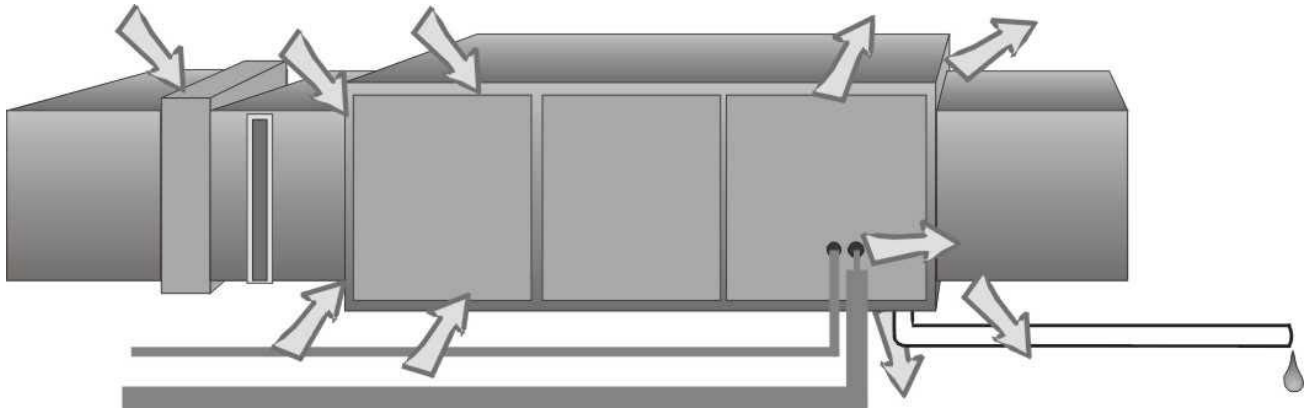
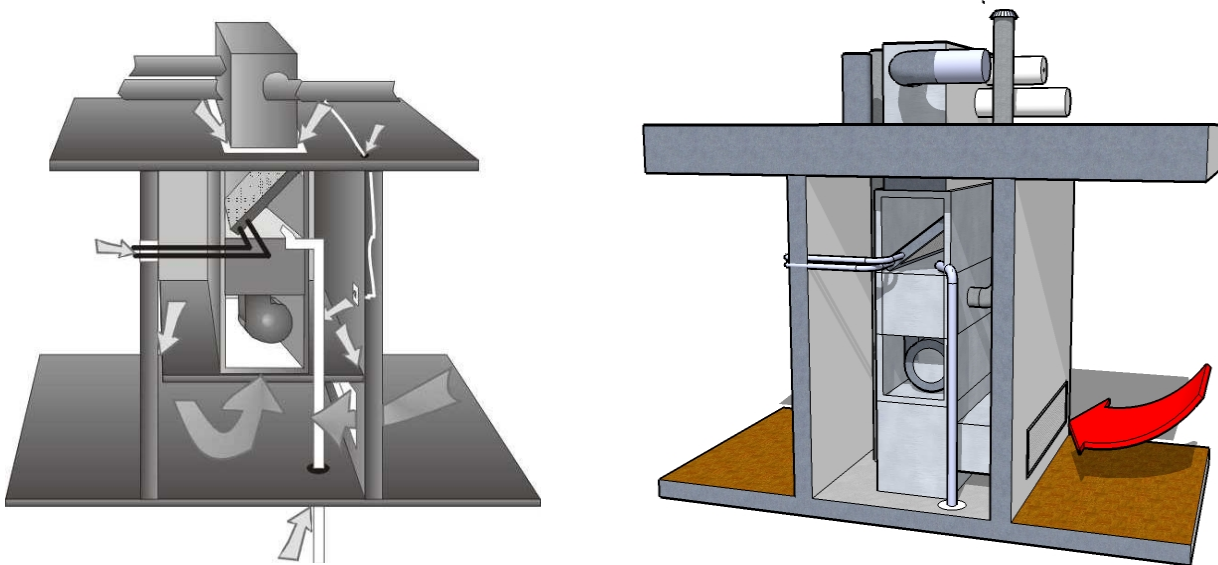

Figure 8-7
Seal All Leaks in Air Handling Unit



Virtually all air handling cabinets come from the factory with leaks, which should be sealed with duct-sealing mastic. Removable panels should be sealed with tape.

Figure 8-8
Shelf-Mounted Systems without Returns



Non-ducted returns can severely depressurize mechanical room closets, not only sapping the system's efficiency, but also creating ideal conditions for back drafting and other air quality problems.

The return should be connected to the home via well-sealed ductwork. All holes to other spaces should be completely sealed.

Figure 8-9
Seal All Leaky Takeoffs

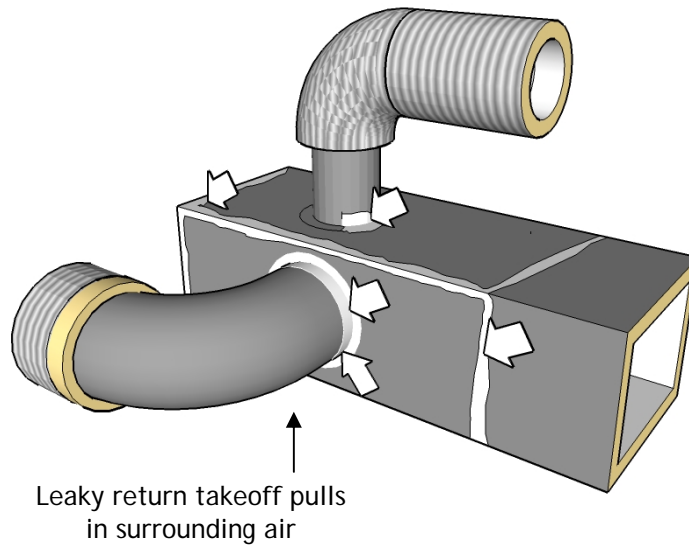

Figure 8-10
Sealing Leaky Boots



Use mastic to completely seal all leaky seams and holes. Use mesh tape with mastic to cover cracks over 1/8-inch wide.

Duct Design

Sizing and Layout

The size and layout of the ductwork affects the efficiency of the heating and cooling system and comfort levels in the home. The proper duct size depends on:

- The estimated heating and cooling load for each room in the house.
- The length, type, and shape of the duct.
- The operating characteristics of the HVAC system (such as the pressure, temperature, and air speed).

The lower temperature of the heated air delivered by a heat pump affects the placement of the registers. A heat pump usually supplies heated air between 90°F and 100°F. At these temperatures, air leaving registers may feel cool. They should be placed so as to avoid blowing air directly onto people. Fuel-fired furnaces typically deliver heated air at temperatures between 110°F and 120°F, 40°F to 50°F greater than room temperature, so placement of the supply registers is less important to maintain comfort.

HVAC contractors usually locate supply registers on room centerlines and place the return air grille(s) near the interior, typically in a central hallway. Most standard designs have only one return for each floor.

Figure 8-11
Comparison of Air Flow in Different 6-inch Ducts

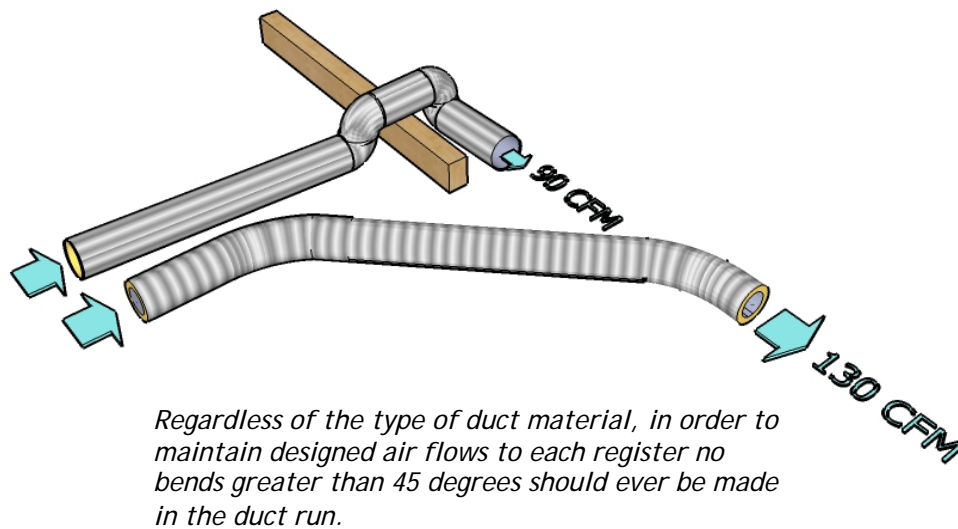

Some contractors try to use one size duct through out the house. One size does not fit all situations. The standard approach of using all one size branch ducts with a single return works for some homes, but can create operating problems for others, including:

- Too much heating and cooling supplied to small rooms, such as bathrooms and bedrooms with only one exterior wall.
- Inadequate airflow, and thus, insufficient heating and cooling, in rooms located at the greatest distance from the air handler.

The heating and cooling industry has developed comprehensive methods to size supply and return ductwork properly. These procedures are described fully in *Manual D, Residential Duct Systems* published by the Air Conditioning Contractors of America. The advantage of proper design is that each room receives air flow proportionate to its heating and cooling load, thus increasing overall comfort and efficiency. The following thoughts, while no substitute for a *Manual D* calculation, should improve system performance:

- If two rooms have similar orientation, window area, and insulation characteristics, but one room is considerably farther from the air handling unit than the other, the ductwork going to the farthest room may need to be larger.

- Bonus rooms over garages often need larger supplies because of the extra heat passing through the roof, and the floor area over ambient air. Insulation installed to code requirements will reduce the need for extra cooling and heating capacity.
- Rooms with large window areas may warrant a larger supply duct, regardless of room size. Proper calculation of solar load will determine requirements. Double pane, low-e windows and shading can reduce the solar load.
- Likewise, large, well-insulated rooms with few windows, only one exterior wall, and with conditioned space above may need only one small duct.
- Ductwork air flow can be adjusted to meet each room's needs using manually controlled dampers and an air flow measurement device. However, velocity will increase for a given plenum pressure, and may increase noise at the register if the duct is oversized.

Return Air Flow Considerations

Air conditioning systems not only supply air flow to rooms, but they pull air out of the rooms, also. If the return flow is not free to exit the space, the pressure will build up in the room and it will look for the path of least resistance. This alternate path could be to either the outdoors or the attic. Window frames can be leak sites to the outdoors. Electrical outlets and switch boxes often communicate with the attic. Bathroom plumbing has vent pipes running up through the attic and is often closed off to limit moisture escape into the rest of the house.

Besides the loss of conditioned air, which you have paid for, the lost air must be replaced before reaching the fan or the remainder of the house would be at a lower pressure than the air outside the house. This causes infiltration, which can bring additional heat, humidity and other undesirable elements with it as described in Chapter 2. (Less than 3 Pascals pressure differential is acceptable for a well balanced system.)

Each space that has a door that is commonly closed, bedrooms, bathrooms, etc. should have adequate provision for air return flow. There are several ways this can be done. A complete return duct system could be used, but would add to the cost substantially. Since most house duct systems in Louisiana are located high on the wall or in the ceiling, floor level return is desirable to provide good ventilation, and to de-stratify the rising hot air in the winter. With under floor supply ducts, high mounted returns can be best.

The return openings will need to be 2 to 3 times the size of the supply duct depending on system design velocities. (Although not always a good basis for design, a “Rule of Thumb” to consider is 1 square inch of wall opening per cfm delivered to the room.) This can take the form of cutting off the bottom of the doors with a ¾ inch undercut of a 32” door (24 sq. in.) combined with a standard transfer grille having a width of 14 inches and 80% net free area whose height increases per the cfm delivered to the room divided by 25.

For typical bedroom having 70 cfm supplied and 24 square inches of return opening under a 2’8” door undercut ¾ inch and a nominal 14 inch wide transfer grille in the wall, the height of the transfer grille would need to be 4.1”, yielding approximately 70 square inches of total return opening from the bedroom to the air handler’s return grille.

$$32'' \times .75'' + [(14'' \times 4'') \times .80] = 68.8 \text{ square inches}$$

Other Alternatives

A “jump” duct can be installed over the door frame or some other convenient point such as an interior wall as long as it is insulated.

Figure 8-12
Jump Duct

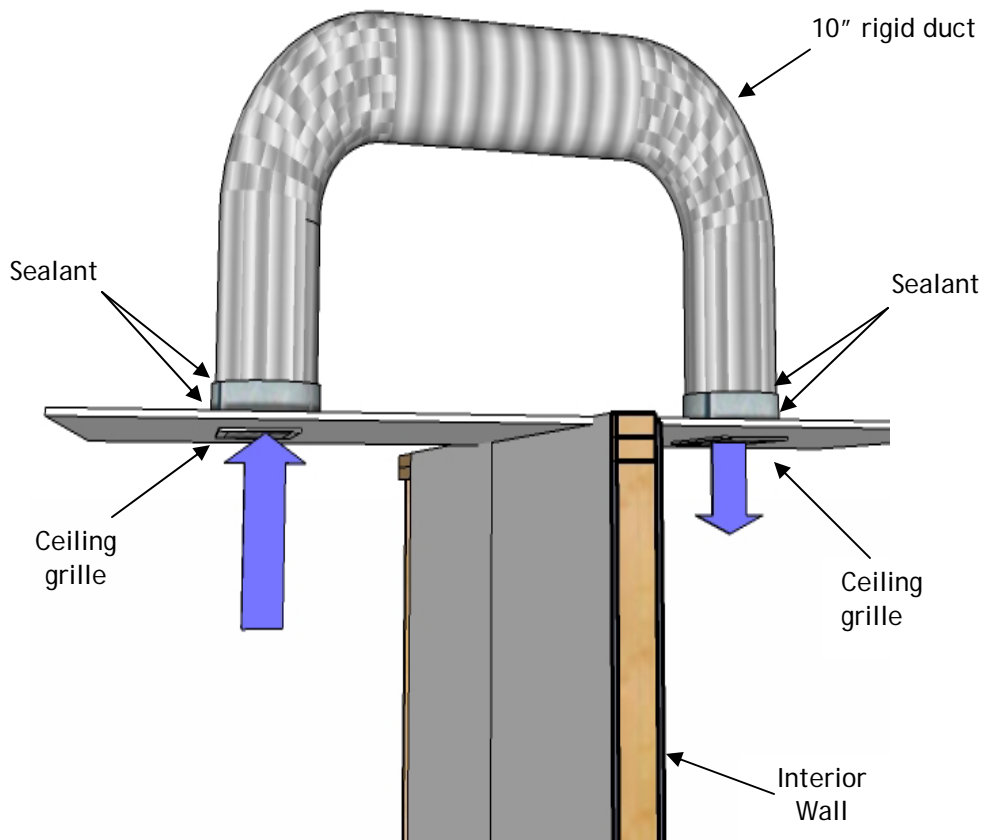

A baffled (for sound) vent above the door may suit the situation if planned for in the framing.

Figure 8- 13
Transfer Grilles – Over Doors

Back to back grilles on both sides of partition with interior baffles or offset grilles when no partial stud present. Rigid duct board makes a good baffle.

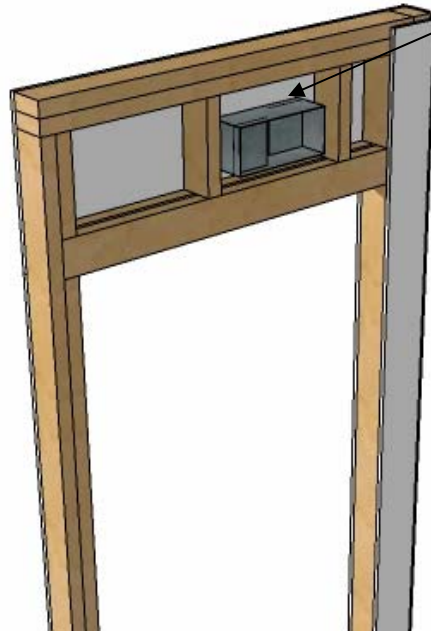
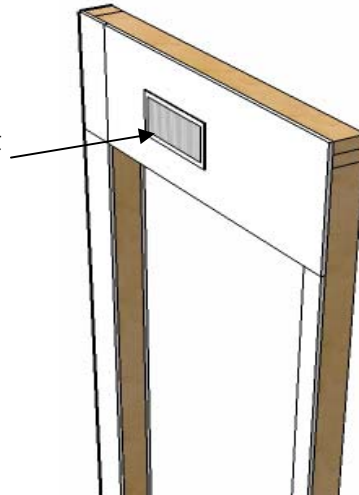

Sound and light baffles; use a "soft" material for baffle. Seal framing cavity around both sides.

Figure 8-14
Transfer Grilles – In Wall

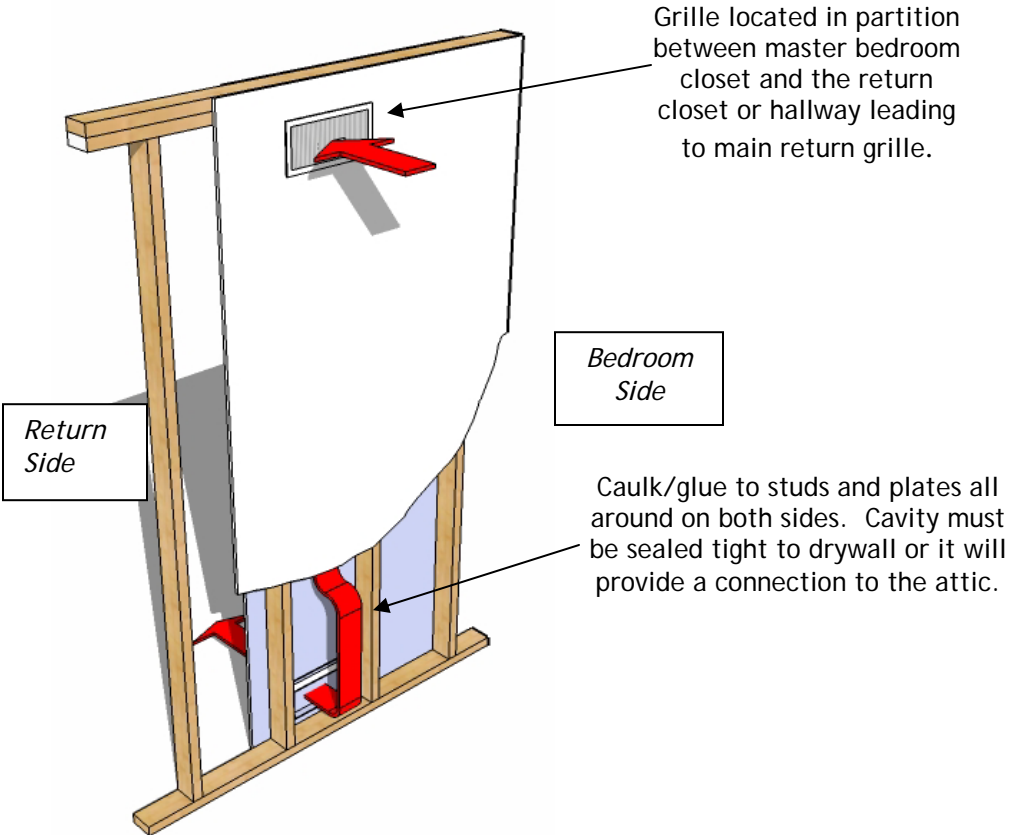

Louvered passage doors are also a good solution if sound or moisture is not a problem.

Figure 8-15
Louvered Passage Doors

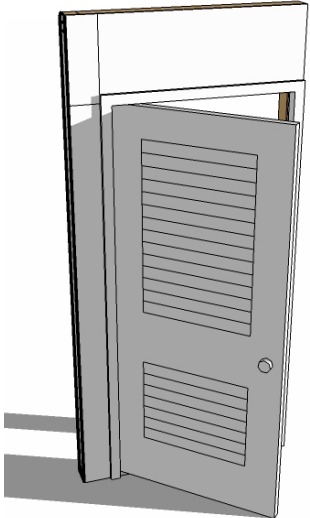

Conclusion

Proper air flow provides comfort and temperature control in the house. Good duct design moves the right amount of air to each space with little sound. Although simple in appearance, the duct system is just as critical to a comfortable and economical home as a high seer air conditioner or abundant insulation. In fact, a leaky, inadequate duct system can undo all the effort put into these other systems.

Insist on a properly sized and designed duct system to compliment the other equipment you are buying. This is no place to save a few dollars as you will be paying for it on every utility bill for the life of the house. If the house will have high ceilings in some parts, investigate keeping equipment and all duct work inside the envelope. By doing this leaks don't hurt performance nearly as much. If duct work must be located in the attic, make certain that it is well sealed permanently and well insulated. It may cost a little more but it will save you money every month.

Notes:

Chapter 9

Water Heating, Appliances and Lighting

Water heating, appliances, and lighting account for a large portion of a home's overall energy consumption. When considering the purchase of this equipment, it is important to consider the energy costs of operating the equipment along with the initial cost of the equipment.

Water Heating

Energy costs for water heating can be as great as those for heating or cooling a house. However, it is easy to cut those bills dramatically with conservation measures and water heating alternatives.

Energy Conservation for Water Heating

No matter what type of energy source is used to heat water, be certain to take advantage of the savings from conservation measures:

- Lower the temperature setting on the water heater to 120°F.
 - Saves energy
 - Reduces the risk of injury from scalding
 - Provides plenty of hot water
 - If hotter temperatures are needed for washing dishes, select a dishwasher with a booster heater
- Wrap the outside of the water heater tank with an insulation jacket. Simple to install – payback is less than 1 year
 - Do not cover the relief or drain valve
 - For gas water heaters, do not block the air inlet to the burner or the flue vent on the top
- Insulate at least four feet of all pipes connected to the unit, but pipe insulation is inexpensive and the slit foam tube type is easy to apply. Therefore, it will pay to insulate as much of the outlet run that is accessible. If the inlet pipes are exposed to cold temperatures, insulate those, too.
- Low-flow showerheads provide a 1-year payback. Well-designed fixtures deliver water at 2.5 gallons per minute or less and still provide plenty of force.
- Heat traps keep heat from escaping from the water heater.
- Low-flow aerators on sink and lavatory faucets.
 - Kitchen sink may need a higher volume flow faucet for filling pots and pans more quickly.

Water heaters come in a range of efficiencies, warranties, and fuel sources. Their efficiencies are measured by a rating known as the *energy factor* (EF).

Figure 9-1
Typical Breakdown of Hot Water Use



Gas Water Heaters

Gas water heaters are typically less efficient, but also cost less to operate than electric water heaters. This is because of the energy loss associated with electrical distribution. Also, with gas-fired power plants providing electricity, any increases in the price of natural gas will be reflected on the price of electricity. One major advantage of gas water heaters is reliability. During hurricanes, natural gas supplies are more reliable than electricity supplies. When a hurricane knocks out electricity for a week or longer it is nice to be able to take a warm shower. A gas water heater can make this possible.

High efficiency gas water heaters can have energy factors above 0.80. In addition to variations in insulation, gas water heater efficiency is also affected by burner design, the shape of the flue baffles which slow the hot exhaust gases down to increase heat transfer to the water, and the amount of surface area between the flue gases and the water.

Higher efficiency gas water heaters have blowers for venting or delivery of combustion air. Most of these units can be vented out of the sidewall of the home rather than the roof because of the forced air blower.

Fuel-fired water heaters should be located in unconditioned spaces that are isolated in terms of pressure and air leakage from the living area. If fuel-fired water heaters are located in the interior spaces, such as interior mechanical rooms connected to conditioned spaces or laundry rooms, they should include provisions for outside combustion air, such as a direct-vent unit. Direct-vent units have a double flue pipe that includes both an intake for combustion air and a flue for exhaust gases.

When shopping for a water heater, use the Energy Guide sticker to compare the estimated annual energy cost for a specific water heater with comparable models. The estimated annual cost shown in bold print on the sticker uses a national average cost of fuel, which could differ significantly in your area.

Electric Water Heaters

For electric water heaters, higher efficiency units have energy factors up to 0.97. Often, the additional cost of a high efficiency unit is quite low compared to the savings. Because of the high cost of electric water heating, more efficient options such as heat recovery units, heat pump water heaters, and solar water heaters should be considered.

Figure 9-2
Insulating Jackets for Electric and Gas Water Heaters

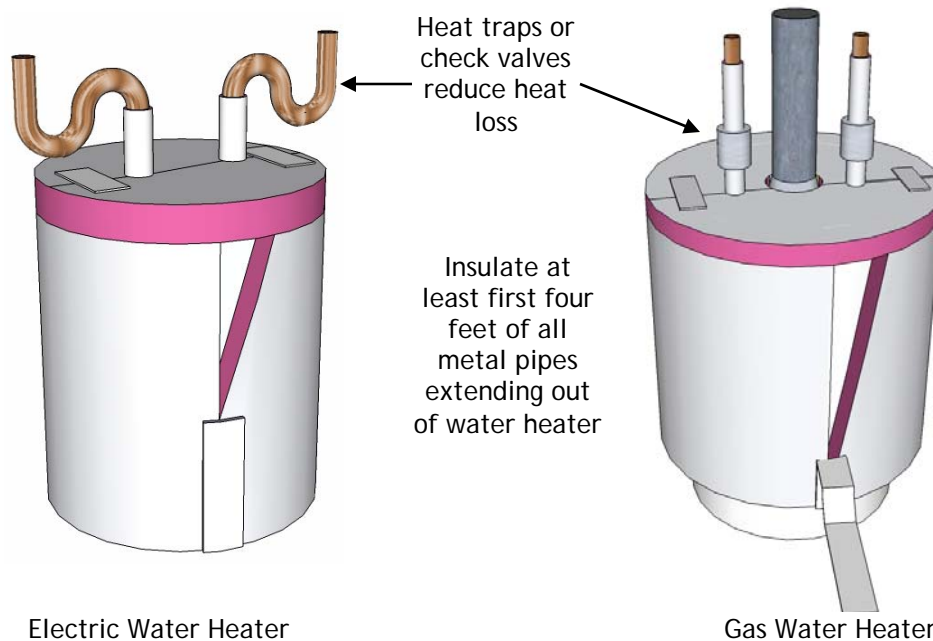

Heat Recovery Units

A *heat recovery unit*, also called a *desuperheater*, recovers excess heat from an air conditioner or heat pump to provide “free” hot water. The heat is captured from the air conditioner’s refrigerant piping between the outlet of the compressor and the inlet of the condenser (outside unit). A heat exchanger on this line extracts heat from the superheated, high pressure refrigerant gas. The refrigerant is hot enough to lose some heat without condensing into a liquid. The refrigerant gas then continues to condense at a lower temperature. For more information on residential air conditioning, see Chapter 7.

During the summer, the desuperheater can usually provide 100% of the hot water needs of a family while also improving the efficiency of the air conditioner or heat pump. In the spring and fall, with no heating or cooling, the desuperheater is ineffective. In the winter, if connected to a heat pump, the desuperheater will still provide hot water more efficiently than a conventional electric water heater. The energy savings from a desuperheater connected to a central air conditioner depend on how often the air conditioner is used. Savings are typically 20% to 40% of annual water heating costs.

The size and efficiency of the water heater and cooling equipment will affect the performance of the desuperheater. Combining desuperheaters with new, higher efficiency air conditioners or heat pumps, which have lower refrigerant temperatures, can reduce the energy savings. The HVAC

system should be at least 2 tons in size to be used effectively with a desuperheater. Before installing a unit, make sure that it will not void warranties on mechanical equipment.

Heat Pump Water Heaters

Heat pump water heaters operate at about twice the efficiency of standard electric water heaters. They use surrounding air as a heat source. As they extract heat from the air, they provide some dehumidification and cooling.

Figure 9-3
Heat Pump Water Heaters

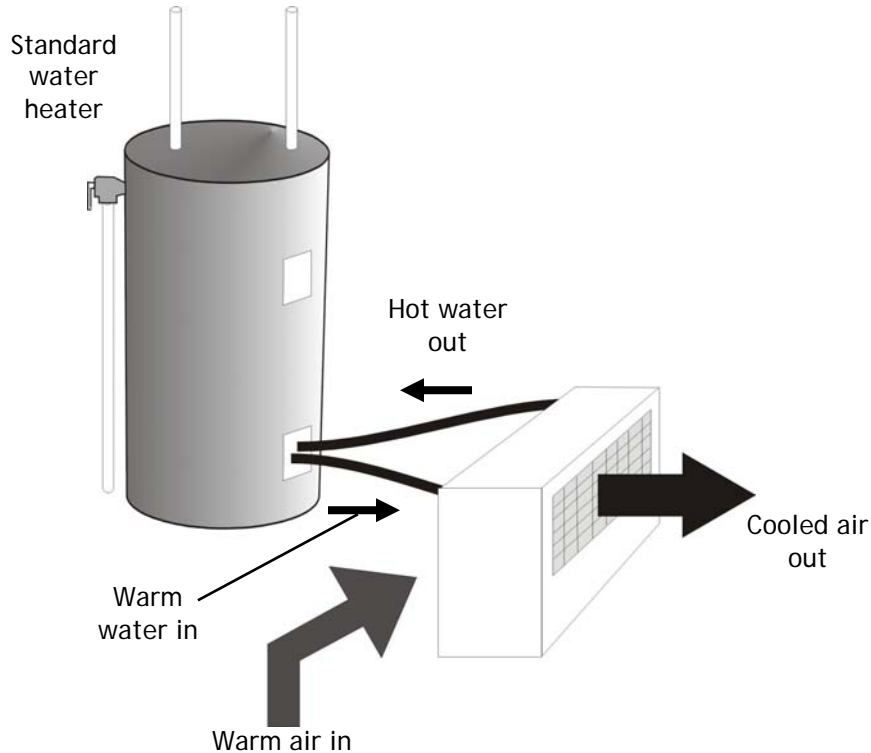

While the cool dry air is an advantage in summer, it is detrimental in winter. It is best to locate the unit in an unconditioned area, such as an unheated basement, where the cooling effect will not cause winter discomfort or higher heating bills. The area must stay above 45°F for the unit to operate properly.

Heat pump water heaters are sold either as separate cabinets which are connected to a conventional water heater or as packages complete with the hot water storage tank. When operating, they are about as loud as an air conditioner, so do not locate them where noise will be a problem.

Solar Water Heaters

For homes that use a large amount of hot water and receive full sun year-round, solar water heaters may be economical. Most solar water heaters operate by preheating water for a standard water heater. Normally, gas or electric water heaters bring incoming cold water to a desired temperature of about 120°F. A solar water heater uses sunlight to preheat cold water and stores it, often at temperatures well above 120°F.

If the solar-heated water is hot enough, the standard water heater does not need to add more heat. If the water is cooler than needed, the standard water heater will operate as a backup to increase the temperature. Thus, the temperature or availability of hot water is never affected. Of course, even when the solar-heated water is at temperatures below 120°F, the backup unit will use less energy than it would to heat incoming cold water.

A variety of solar water heaters are available commercially, most of which should last 15 years or longer. They are divided into three categories: active, thermosiphon, and batch. In *active* and *thermosiphon* water heaters, solar panels or collectors trap the sun's heat. Water or other fluid running through the collectors absorbs heat and increases in temperature. The liquid then travels to a storage tank where the heat it gains is stored.

Active systems use electric pumps to move the liquid from the collectors to the storage tank. Thermosiphon water heaters require no outside power because they use the natural tendency of water to rise as its temperature increases to push water from the collectors to the storage tank, which must be located higher than the collectors. The hot fluid then passes through a heat exchanger where it heats the domestic water or the incoming water passes through a heat exchanger in the storage tank.

Figure 9-4
Active Solar Water Heating Systems

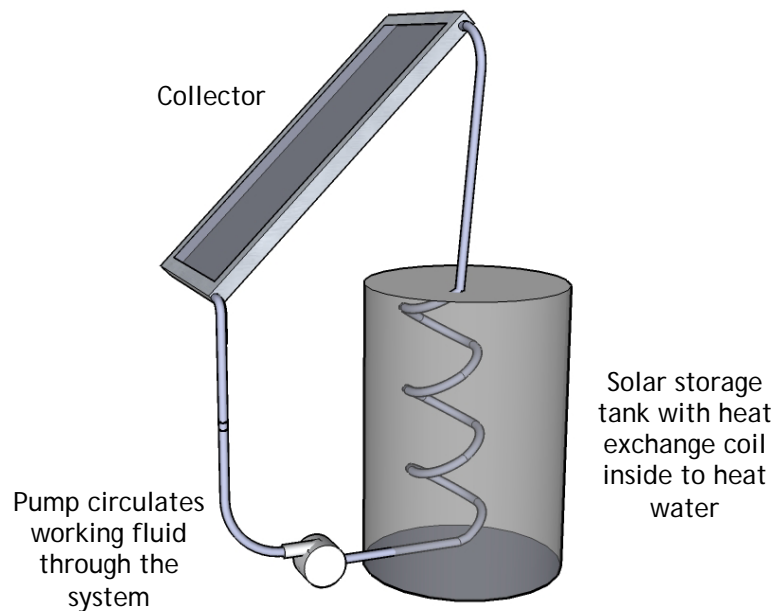

Some solar water heaters use a single, large storage tank that has a backup source of water heating. Other systems use a standard water heater as a backup and a separate solar storage tank. Active and thermosiphon systems can supply up to 70 percent of a family's annual hot water needs.

The tilt angle of the collector — the angle between the glazing and the horizon — should be within 15 degrees of the latitude. For Louisiana, the tilt angle can be between 18 and 50 degrees. The best tilt angle for a year-round solar device, such as a solar water heater, is 35 to 45 degrees. For solar collectors used only for winter heating, tilt angles can be raised to between 50 and 60 degrees.

Solar water heaters must be protected from freezing. Active and thermosiphon systems use nonfreezing fluids or automatic drain systems to prevent freezing.

Batch water heaters, also called breadbox water heaters, are simpler than active or thermosiphon systems. However, they provide less hot water, usually about 15 to 40 percent of a family's yearly demand. Batch water heaters combine the collector and storage tank in one box. The box has insulated sides, a clear cover, and one or more tanks inside. In some cases, large tubes are used instead of tanks. A batch water heater can typically store 30 to 60 gallons of hot water.

On a sunny day, sunlight travels through the glazing of the batch unit and strikes the tanks, which are flat black in color. In most cases, the tanks are covered with a special selective surface coating that readily absorbs sunlight, but reduces heat loss from the tank. When the tanks absorb the sun's energy, the water inside the tanks is heated. Local water pressure pushes the solar-heated water into the regular water heater whenever a fixture or appliance, such as a shower or dishwasher, is drawing hot water. Batch heaters are manufactured and sold commercially. However, because of the simplicity of the design, some people build their own.

The collectors for any type of solar water heater should be located as close as possible to the water heater tank to minimize the connecting piping. The glazing should face within 45 degrees of due south. Collectors are usually located on the roof, but they can be attached to supports on the side of a house or on the ground. Because batch water heaters combine collectors, storage tanks, and water, they are heavy. Adequate structural support must be provided when they are located on the roof.

Figure 9-5
Batch Solar Water Heating System

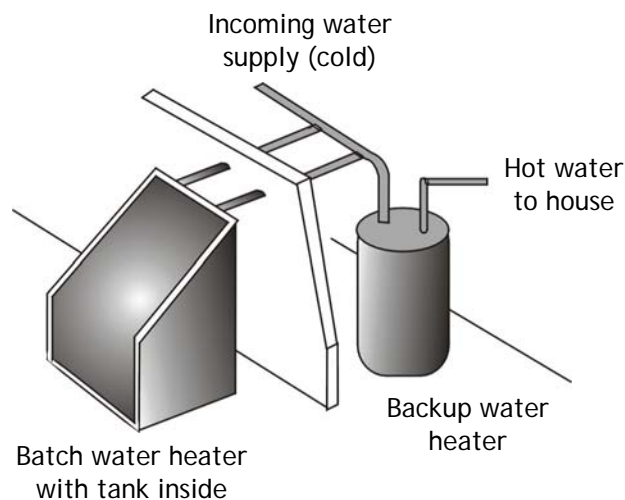

Water inside the tanks of a batch water heater will only freeze on extremely cold nights. However, the water in the pipes that connect the batch heater to the inside can freeze at temperatures around 32°F. A special *freeze prevention drip valve* should be used on a batch water heater.

Solar water heating can provide year round savings. Households that use a large amount of hot water and can adapt the time when hot water is used to match when it is available will benefit the most. Savings will be greatest if laundry, dishes, and bathing are done between noon and early evening - after the sun has heated the water stored in the tank.

Instantaneous Water Heaters

Instantaneous water heaters use higher capacity electric coils or gas burners to heat cold water only when there is a need for hot water. They save energy in two ways: they have no storage tank so there is no need to keep stored water continuously warm, and gas-fired burners on these units usually heat water more efficiently than gas tank-type water heaters. Conventional water heaters keep 30 to 50 gallons of water at a constant temperature - 24 hours a day.

Instantaneous units must be sized carefully for their planned use. A small unit may provide heating for only one faucet or appliance at a time, so a higher capacity model or several units are generally needed to provide hot water for conventional residential uses. By eliminating the standby losses and increasing efficiency, instantaneous water heaters may save 10 to 20 percent of a household's usual water heating bill.

In general, instantaneous water heaters are not particularly cost-effective investments. It is usually more economical to use conservation measures such as low-flow showerheads, insulated tank jackets, reduced thermostat settings to lower standby losses, and to install conventional, high efficiency water heaters.

Appliances

Heating, cooling, and hot water are usually the biggest portion of energy needs in Louisiana homes. However, the cost of operating major appliances is significant. While most new appliances offer a wide variety of features, many models are not designed to be energy efficient. When choosing appliances, it is important to consider their operating costs - how much energy they require to run - as well as the purchase price and the various features and conveniences they offer.

Appliances which operate efficiently may cost more to buy, but the energy savings they provide make them a good investment. For example, running a standard refrigerator over its life of 15 to 20 years costs about three times as much as its purchase price. An energy efficient model can save hundreds of dollars over the life of the appliance. Table 9-1 shows typical annual energy costs for a variety of appliances.

Table 9-1
Typical Energy Costs for Appliances

Appliance	Standard Model (\$/yr)*	High Efficiency Model (\$/yr)*	10-year Savings
Top Mount Refrigerator	47	38	\$90
Side-by-side Refrigerator	68	54	\$140
Chest Freezer	39	35	\$40
Upright Freezer	76	67	\$90
Electric Range	45	36	\$90
Gas Range	34	27	\$70
Clothes Washer	68	15	\$530
Electric Clothes Dryer	48	37	\$110
Gas Clothes Dryer	23	19	\$40
Dishwasher	47	19	\$280

*Analysis assumes cost of electricity to be \$0.10 per kWh.

In addition to saving money on operating costs, energy efficient appliances give off less waste heat than standard models. Therefore, they help keep rooms inside the house cooler during warm weather.

EnergyGuide Label

To compare the energy usage of an appliance, use the EnergyGuide label. Federal law requires that manufacturers display this label on all new refrigerators, freezers, water heaters, dishwashers, clothes washers, and room air conditioners. Energy Guide labels are not currently required on kitchen ranges, microwave ovens, clothes dryers, demand-type water heaters, and portable space heaters.

The large number on the EnergyGuide label tells how much that appliance will cost to operate each year based on an estimate of the amount of energy used and an average national energy costs. The rating for a particular model is shown on a line scale that compares its energy cost against the model with the lowest and highest annual energy costs. Much like the federal miles per gallon ratings for automobiles, the actual amount of energy used and its cost will vary according to local prices and each family’s lifestyle.

The EnergyGuide label also provides the name of the manufacturer, model number, type of appliance, and capacity. It has a yearly cost table that shows a range of energy rates and the total annual cost to operate that particular appliance at each rate. Use exact energy rates from local utilities to estimate operating costs for the appliance.

Figure 9-6
EnergyGuide Label

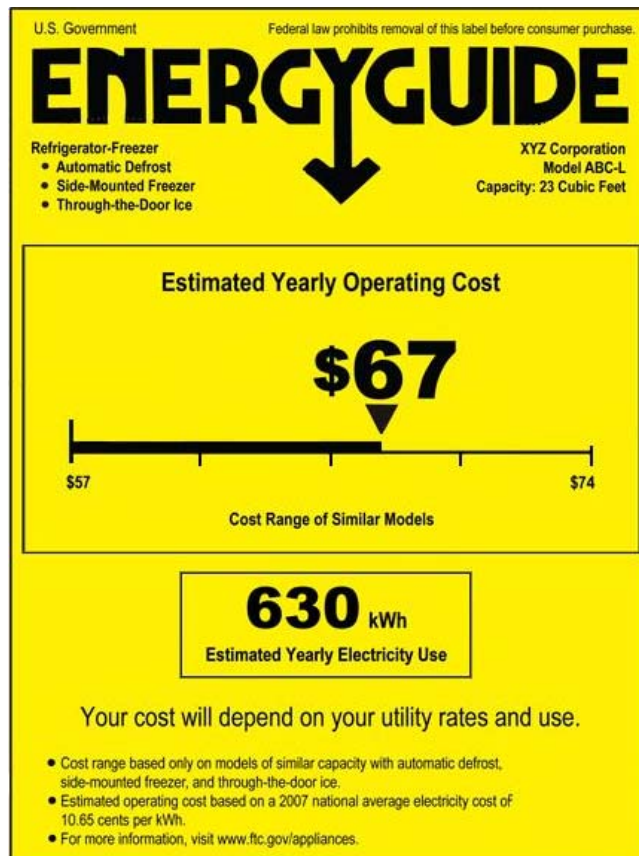

Appliance Shopping Checklist

All Appliances

- Use EnergyGuide label to help select unit. Find the savings in operating costs for more efficient appliances. Divide the savings per year into the extra purchase price to get the payback period. Paybacks of less than five years are generally attractive.

Refrigerators

- The most efficient models are in the 16 to 20-cubic foot range.
- Side-by-side refrigerator/freezers use more energy than similarly sized models with freezers on top.
- Features such as automatic icemakers and through-the-door dispensers add somewhat to energy use.
- Units that are more square, rather than rectangular, also save energy, but may not be as convenient to use.
- Manual defrost units save considerably more than frost-free units, but create more work for the homeowner.
- Look for a power-saving switch that turns off a condensation-prevention heater. Keep this switch off unless the unit experiences significant condensation.
- New generations of refrigerators that do not use chlorofluorocarbons (CFCs) exceed the minimum standards of NAECA by about 30% - the result of the electric utility-funded Super Efficient Refrigerator Program (SERP).
- Try to install the refrigerator in a cooler location - in particular, it should not receive direct sunlight.
- The refrigerator should operate between 36°F and 38°F, and the freezer should be 0°F to 5°F. Adjust temperatures to this range.

Dishwashers

- Water heating accounts for about 80% of energy use.
- Models that use less water also use less energy.
- Models should have light, medium, and heavy cycle options — water use for one dishwasher is 7.5 gallons for a light cycle, 11 gallons for medium, and 13 gallons for heavy.
- Models should have an energy saving "air dry" or "no heat dry" switch.
- Choose a unit that contains a supplemental or booster water heater; then set your water heater to 120°F. Make certain the unit still provides 160°F to the sanitary cycle if desired.
- Minimize pre-rinsing of dishes unless necessary; always rinse in cold water.
- Wash only full loads.

Clothes Washing Machines

- Choose a machine that offers several wash and rinse cycles and several sizes of loads.
- Front-loading models feature faster spin cycles, which dry clothes better, and use less water than top-loading models; in addition, frontloading models usually get clothes cleaner.

Clothes Dryers

- Energy-saving switches and models that detect "dryness" and shut off automatically offer considerable energy savings.
- Some units have moisture sensors in the drum, which save about 15% over standard dryers.

- Others have a temperature sensor in the dryer exhaust, which saves about 10% over standard units.
- If clothes that usually need ironing are removed while slightly damp, they can be hung up to save on dryer and ironing energy use.

Cooking

- Convection ovens are about 1/3 more efficient than standard ovens, but cost much more.
- Electric cooktops with ceramic glass covers are slightly more efficient than coil or disk electric stoves; induction elements, which use electromagnetic energy to heat the pan, are the most efficient, but also cost much more.
- Higher cost models may not save enough energy to make up the cost increase.
- Large kitchen exhaust fans, especially those for side-vented stoves, which can exhaust 400 to 700 cfm should be avoided. They can create considerable negative pressures in tight homes and may cause backdrafting of combustion appliances. The code only requires 100 cfm of ventilation.

Lighting

Standard incandescent bulbs are the most common lighting source for homes. However, incandescent lamps are quite inefficient. They convert only 10 percent of the electricity to lighting; the remainder is waste heat. The lighting industry has responded to the need for energy efficiency with a wide range of excellent products. The most notable of these options are:

- Compact fluorescents that use thin tubes and require less than 1/3 of the electricity to provide as much light as standard incandescent lamps. These products can also provide the same quality of light as incandescent lamps.
- Lower wattage fluorescent tubes, along with efficient electronic ballasts, can reduce the energy needed by a standard 2-lamp, 4-foot fixture from 92 watts to about 60 watts. There are many products available with a high color rendition index (CRI), which measures the ability of a lamp to illuminate colors accurately.
- High pressure sodium and metal halide lamps, mainly intended for exterior use in residences, are four to six times more efficient than standard exterior lamps.

There is great opportunity for originality and ingenuity in residential lighting design. A home combines more functions and needs than most other buildings, yet energy efficient lighting can be achieved at minimal cost. Of course, the needs of each home must be considered individually, but certain conservation measures are applicable to all home designs, including:

- Energy efficient fixtures and lamps for areas of high continuous lighting use, such as the kitchen, sitting areas, and outside the home for safety and security.
- Local task lighting for specific activities such as working at a desk, on a kitchen counter, or in a workshop.
- Accent lighting for areas that need more light enables the overall level of lighting in a room to be reduced.
- Timers and light-sensitive switches for exterior lighting.
- Daylighting – using sunlight as the light source in areas normally occupied during the day.
- Solid-state dimmers and multilevel switches which allow variable lighting levels.

For help in selecting the right bulb, go to: http://www.energystar.gov/index.cfm?c=cfls.pr_cfls

The amount of light a lamp provides is measured in lumens. The electrical energy used to provide that light is measured in watts. The efficiency – called efficacy – of a lamp is measured in lumens of light produced per watt of electricity consumed. Figure 9-7 provides comparative efficacies of different lamp types.

Figure 9-7
Efficacy of Different Lighting Types
(Lumens per Watt)

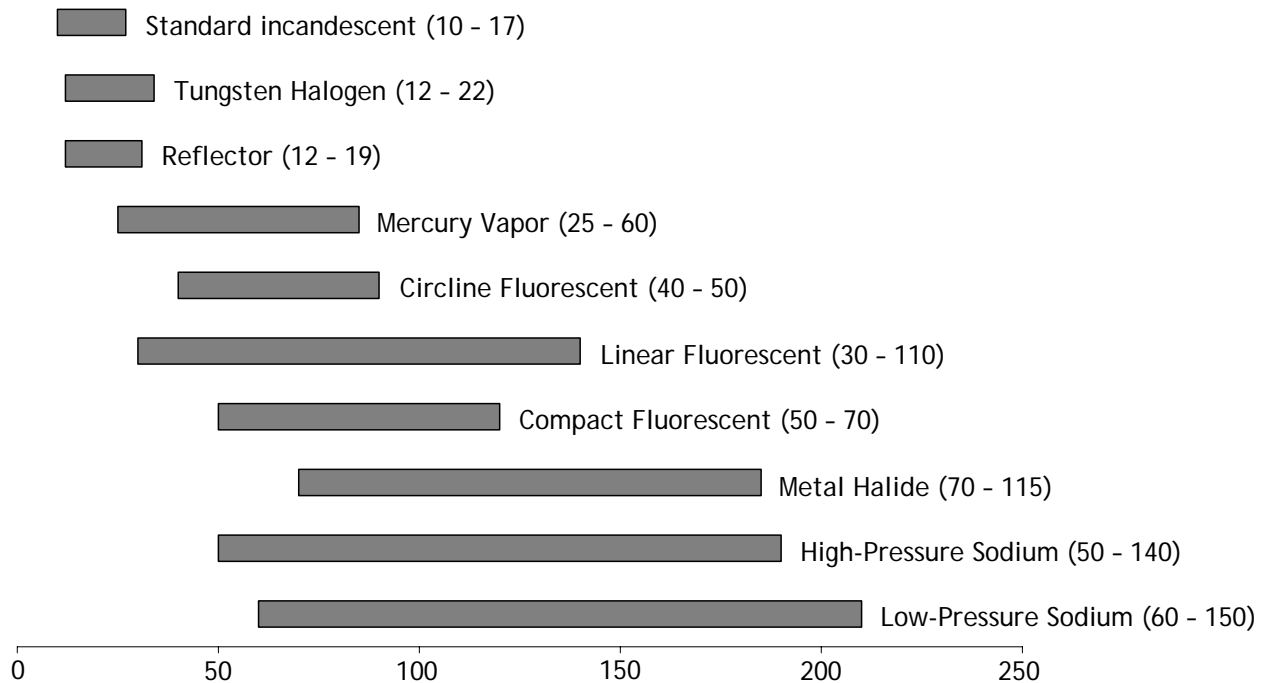

The lighting level depends on the efficacy of the light source and the ability of the lighting fixture to distribute the light effectively. High efficacy lamps and efficient lighting fixtures reduce wattage requirements while still providing the desired light levels.

In designing a lighting plan, consult knowledgeable professionals about optimum lighting levels and different types of fixtures and lamps. Table 9-2 shows sizing guidelines for tube-type fluorescent lighting systems.

Table 9-2
Fluorescent Lighting Guidelines
(using T-8 lamps and electronic ballasts)

Type of Room	Size of Room	Lighting Needed (Watts)
Living room, bedrooms, family room, or recreation rooms	Under 150 sq. ft.	40 to 60
	150 to 250 sq. ft.	60 to 80
	Over 250 sq. ft.	.33 watt/sq. ft.
Kitchen, laundry, or workshop	Under 75 sq. ft.	55 to 70
	75 to 120 sq. ft.	60 to 80
	Over 120 sq. ft.	.75 watt/sq. ft.

Compact Fluorescent Lamps

Table 9-3 shows the purchase and operating costs of incandescent bulbs and compact fluorescent lamps. The options are grouped by comparable lumen output so lamps for similar uses can be compared. The total cost is determined for a period of 10,000 hours, which is the typical life of a compact fluorescent lamp.

For example, a standard 75-watt incandescent lamp costs \$54 for electricity and bulb replacements over 10,000 hours of operation. Compare that to a new 19-watt CFL, which has a similar light output. For the same 10,000 hours of operation, the cost of the lamp will be \$2.50 and no replacements will be needed.

Table 9-3
Purchase and Operating Costs of Incandescent Lamps and CFLs

	Wattage	Typical Purchase Cost (\$)	Lumens	Rated Life (Hours)	Efficacy (Lumens/Watt)	Electricity Costs for 10,000 Hrs*	Total Cost for 10,000 Hrs
Incandescent and Compact Fluorescent (Cost is for bulbs only)							
Double-life Incandescent	60	\$0.50	780	2,000	13	\$60	\$62.50
Compact Fluorescent	13	\$2.00	900	10,000	69	\$13	\$15.00
Double-life Incandescent	75	\$0.50	1,085	1,500	14	\$75	\$78.33
Compact Fluorescent	19	\$2.50	1,200	10,000	63	\$19	\$21.50
Double-life Incandescent	100	\$0.50	1,530	1,500	15	\$100	\$103.33
Compact Fluorescent	23	\$3.00	1,600	10,000	70	\$23	\$26.00

*Analysis assumes cost of electricity to be \$0.10 per kWh.

Concerns about Mercury in Fluorescent Lighting

Some consumers remain concerned about the mercury contained in compact fluorescent lamps. All fluorescent lamps contain very small amounts of mercury. The lamps create light by exciting the mercury molecules with an electric charge. The molecules then emit ultraviolet light, which is converted to visible light by the lamps phosphor coating.

The amount of mercury in the lamp is different for each lamp, but the lamps typically contain only about 5 milligrams of mercury. This mercury is sealed inside of the tube of the lamp and will only escape if the lamp is destroyed. By contrast, using an incandescent bulb requires almost four times the power required by a comparable CFL. The increased electricity use causes a proportional increase in the power plant emissions required to provide that power. One of the emissions produced by coal-fired power plants is mercury.

With coal-fired electricity generation, a 75 watt incandescent bulb will produce approximately 13.2 milligrams of mercury over the standard life of a CFL. During that same period, a comparable CFL will only contribute to the emission of 3.5 milligrams. This means that replacing an incandescent lamp with a CFL can reduce the overall amount of mercury entering the environment, even if all mercury escapes from the CFL.

Economics of Improved Lighting Designs

When choosing lighting fixtures, consider the long-term energy costs of the fixture as well as the purchase price. Energy efficient lighting alternatives reduce waste heat in summer, thereby saving money on cooling costs and increasing comfort levels. In addition, they typically last much longer than standard incandescent lamps.

Table 9-4 shows a sample lighting comparison between a home with standard, incandescent lighting and a home with a variety of efficient lighting technologies. The energy efficient design costs an extra \$104, but saves \$285 per year on lighting energy bills.

Table 9-4
Sample Improved Lighting Design

Room	Standard Design				Energy Efficient Design				
	Type*	Watts	Hrs/day	kWh/yr	Type*	Extra Cost	Watts	kWh/yr	Annual Savings**
Kitchen	I	150	4	438.0	F	\$30.00	60	87.6	\$13.14
Living	I	150	5	328.5	CFL	\$8.28	56	102.2	\$17.16
Dining (decorative)	I	75	1	136.9	I	---	75	27.4	\$0.00
Bathrooms (2)	I	180	4	262.8	CFL	\$4.50	39	56.9	\$20.59
Hallway	I	150	4	547.5	F	\$30.00	38	55.5	\$16.35
Bedrooms (3)	I	225	2	328.5	CFL	\$4.50	57	41.6	\$12.26
Laundry / Utility	I	100	2	146.0	F	\$25.00	30	21.9	\$5.11
Closets (5)	I	300	1	109.5	I	---	300	109.5	\$0.00
Porch	I	75	4	328.5	CFL	\$2.00	19	27.7	\$8.18
Exterior Floodlight	H	360	8	1576.8	CFL	\$0.00	92	268.6	\$78.26
Total Lighting System				4203.0		\$104.28		1353.1	\$284.99
*I=Incandescent; F=Fluorescent; CFL=Compact Fluorescent									
** Analysis assumes cost of electricity to be \$0.10 per kWh.									

Like any component of a home, the selection of lighting system depends on the needs of the occupants and the economics of the systems. Select a lighting system with a low power density and adequate controls. Less efficient systems can be used in rooms which are rarely used, like closets. In rooms that are used frequently, savings associated with a high efficiency lighting system will grow more rapidly, making the system more cost effective. Make sure that the systems selected are economic for the way the system will be used.

Notes:

Chapter 10

Energy Efficient Roofing

Roofing is often ignored as an energy efficient component of a house, but it has a profound effect on the other systems, especially air conditioning. An efficient total roof system can lower the energy required for cooling a Louisiana home by 30 percent or more. Subdivision covenants may preclude making a good roofing choice and should be checked before planning a new home or buying an existing home if energy bills are important to you.

Dark asphalt shingles have been used for years due to mildew problems associated with our warm, moist climate. These are the worst choice from an energy efficiency perspective. There are new products on the market that are better and are less prone to this problem. There are some Energy Star roofing shingles currently available, with more to come. There are metal roofs that reflect much of the sun's energy, cool off quickly, and can save energy available today, many of which do not look like metal. No matter the style selected, it is important to consider energy costs when selecting a roof system.

The Roof Structure (A Good Foundation!)

To some, anything above the walls is the "roof". To clarify, there is a roof structure which includes rafters or trusses and above that, the roof deck which is a structural diaphragm resisting live loads and shear forces from wind loads on it and the walls. There are several types of roof decks which are of interest here. The common roof deck in residential construction is 7/16" Oriented Strand Board (OSB). This is a popular option because it is less expensive than plywood. The span between rafters of the roof deck and its load determines the required thickness. The typical truss or rafter spacing is 24" on center. A nominal 1/2" thickness of the roof deck may be fine for most light loads like composition shingles, but may deflect, or sag, between supports with a 24" span under heavier roof loads. For even larger spans, such as spaced beams (as opposed to rafters), a thicker tongue and groove deck should be considered. This could be 1 1/4" or thicker tongue and groove plywood, or tongue and groove deck boards with thickness dependant on the span. The Latin phrase "caveat emptor" (let the buyer beware) certainly applies to choosing roofing and roofing contractors.

There are numerous roofing products on the market. We will briefly examine several basic types and address the advantages and disadvantages of each. Many roof types will "choose themselves" based on the desire for increased energy efficiency, the character of the structure, style of architecture, the slope of the roof deck, the annual rainfall, the high/low seasonal temperatures, the cost, or the presence of deciduous trees nearby. These trees loose their leaves in winter so they are apt to clog up gutters and downspouts, but are helpful for preventing the low summer sun from penetrating windows, and good when bare in winter for letting light/heat into windows.

Non-Vented Attics Affect Shingle Life

Shingles over unvented attics are kept at a slightly higher temperature (2 or 3 degrees), which will shorten their life. The effect is equivalent to a 10 degree higher ambient temperature or the

installation of radiant barrier. More significant is that this effect is less than the color of the shingles or the roof orientation.¹

SIPS

Another type of roof deck performs both as structure and insulation. It is about 6 or more inches thick, and can span long distances, or clear the span between eave and ridge. The material is referred to as the Structural Insulated Panel (SIP). It can easily provide R-20 to R-30 insulation with its foam core. This is an excellent deck when one chooses to use a non-vented attic. There are a number of energy efficiency and economic reasons one should examine this alternative. One benefit is being able to place ducts and HVAC equipment in semi-conditioned space. With this construction, the common insulated ceiling joist space is not necessary or desirable. Even without the use of SIPs, the non-vented attic concept can be accomplished by spraying insulating foam on the roof deck and rafters. See www.buildingscience.com for more information on non-vented attics in hot, humid climates.

The underlayment between the top of the roof deck and the roofing above is often asphalt saturated organic (or fiberglass) felt. There are also more expensive and possibly far better materials. These underlayments are a peel and stick type which is water proof. The actual roofing material, as discussed below, is the waterproof (water-resistant) exposed surface on the topmost layer of the sandwich of components.

Energy Efficient Roof Study

The Florida Solar Energy Center, with the sponsorship of Florida Power and Light and the Metal Roofing Alliance performed a study² of the heat gains in houses with different metal roofing materials. The experiment monitored indoor cooling energy use for seven side-by-side homes in Ft. Myers during the summer of 2000. Each home was virtually identical except for roofing material (one had a non vented attic and roof deck insulation). Seven identical, side-by-side, newly constructed Habitat for Humanity homes were built using various roofing materials: dark gray shingles, white shingles, white flat tile, white S-shaped tile, terra cotta S-shaped "Spanish" tile, and white metal. The seventh had an unvented attic with insulation under the deck and standard dark gray shingles. The homes were operated identically to ensure study accuracy. Temperature controls on the air conditioning thermostats of all the houses were set at a constant 77° F. Both occupied and unoccupied homes were studied.

The study showed that white S-tile produced the lowest attic heat gain. However, the home with the white metal roof posted the lowest overall cooling cost. Compared to a dark gray shingle roof, the study reported, "a white, galvanized metal roof should save a customer who lives in an average-sized 1,770 square foot home approximately \$128 or 23 percent annually in cooling costs." Flat white tile offered a savings of 17 percent. Terra cotta roofing, the most popular roofing material in Florida, netted a modest \$15 or 3 percent savings over dark shingle.

The study found that energy savings are most strongly influenced by the solar reflectance of roof materials. The study proves dark gray roofs reflect a mere eight percent of the heat associated with sunlight, while white shingle and terra cotta tile roofs reflect 25 and 34 percent, respectively. White metal and cement tile roofs provide the most dramatic results, reflecting 66 to 77 percent of the sun's energy. The following two tables concisely illustrate the results of this energy savings comparison:

¹ Joseph Lstiburek, pages 18-19; "Understanding Attic Ventilation", Building Science Digest 102, October 2006

Table 10-1
Cooling Performance During Unoccupied Period July 8-31, 2000 ²

Roof Description	Total kWh	Savings kWh	Saved Percent	Demand kW	Savings kW	Saved Percent
Standard dark shingles (control home)	17.03	0.00	0.0%	1.63	0.00	----
Above with sealed attic, R-19 roof deck insulation	14.73	2.30	13.5%	1.63	0.01	0.30%
Terra cotta S_tile roof	16.02	1.01	5.9%	1.57	0.06	3.70%
White shingles	15.29	1.74	10.2%	1.44	0.19	11.80%
White "Barrel" S_tile roof	13.32	3.71	21.8%	1.07	0.56	34.20%
White flat tile roof	13.20	3.83	22.5%	1.02	0.61	37.50%
White metal roof	12.03	5.00	29.4%	0.98	0.65	39.70%

Table 10-2 makes corrections for the variations in equipment performance and is scaled up to the average size Florida home of 1770 sq. ft. This is a better estimate of savings possible with a more reflective roof material.

Table 10-2
Normalized Annual Savings & Demand Reductions from Regression Estimates ¹

Roof Description	Cooling Savings		Peak Demand Reduction	
	kWh	Percent	kW	Percent
Standard dark shingle (control)	0	0%	0	0%
Sealed Attic	620	9%	0.13	5%
Terra Cotta S Tile	180	3%	0.36	13%
White Shingles	300	4%	0.48	17%
White "Barrel" S-Tile	1,380	20%	0.92	32%
White Flat Tile	1,200	17%	0.98	34%
White Metal	1,610	23%	0.79	28%

Cool Roof Color Pigments

The California Energy Commission (CEC) has Oak Ridge National Laboratory (ORNL) and Lawrence Berkeley National Laboratory (LBNL) working collaboratively on a 3-year, \$2 million project with the roofing industry to develop and produce the new reflective, colored roofing products. Cool Roof Color Materials (CRCMs), made of complex inorganic color pigments, reduce the energy needed to cool buildings, and reduce hot-weather strain on electrical grids by reducing summer peak loads.

² Source: Parker, D.S., J.K. Sonne, J.R. Sherwin, and N. Moyer, November 2000. "Comparative Evaluation of the Impact of Roofing Systems on Residential Cooling Energy Demand." Contract Report FSEC-CR-1220-00, Florida Solar Energy Center, Cocoa, FL.

The key to the energy savings is the coating's ability to maintain a high reflectance and a high emissivity. The CRCMs compare favorably to the "white" metal roofing in the tables above. A roof covered with this special coated granular surface absorbs less solar energy and can reduce air conditioning costs by 20%. This in turn could lead to national energy savings of about 0.5 to 2 quads per year by 2010.

For tile, painted metal and wood shakes, the goal is products with over 45% reflectance. For residential shingles, the goal is a solar reflectance of at least 35% to 40%. The new CRCMs contain mixtures of chromic oxide and ferric oxide. The materials look dark in color yet reflect most of the sun's energy. How can dark roofs reflect as much energy as white roofs, or even more? The trick is in the eye of the beholder. Solar radiation consists of ultraviolet, visible, and infrared (IR) energy, but our eyes see only the visible portion. White roofs reflect most of the visible light spectrum, which mixes together to look white to our eyes, while dark roofs absorb most of the visible light, looking dark. Most solar energy, however, is in the IR region, which is not visible. CRCM roofs reflect more than 60% of the IR solar energy that strikes them.³

Figure 10-1
Color Standard Cool Roof Color Materials

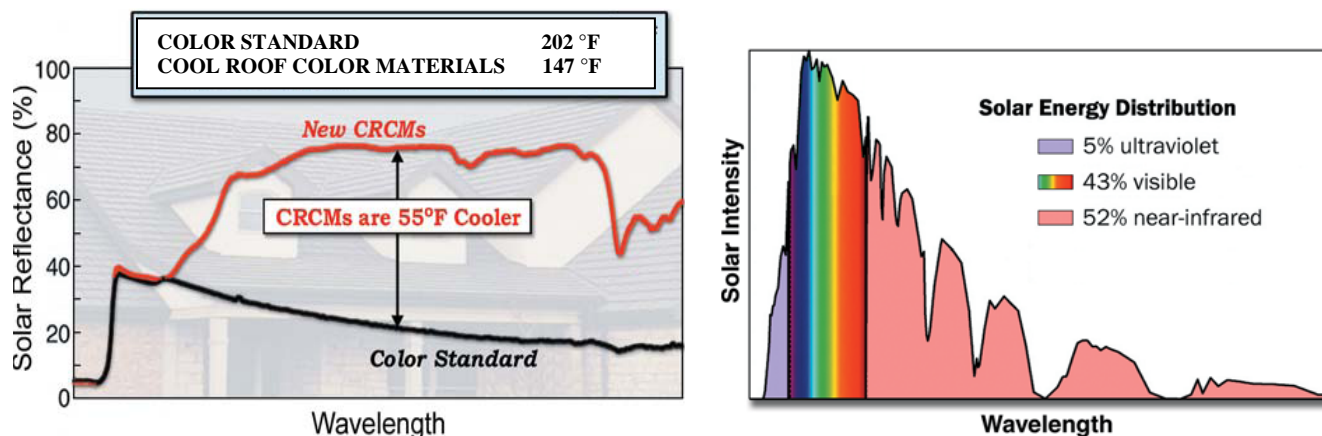

Comparative heat buildup and solar reflectance in cool roof color materials and standard roofing materials.

Distribution of solar energy in the ultraviolet, visible, and near-infrared wavelengths.

What is Emissivity?

The emittance of a material refers to its ability to release absorbed heat. Scientists use a number between 0 and 1, or 0% and 100%, to express emittance. With the exception of a shiny metallic surface, most roofing materials can have emittance values above 0.85 (85%). One example is a chrome plated wrench left in the sun, which is hot to the touch because it has a low emissivity value.

Link Between Energy Savings and Emissivity³

Emissivity-Radiation is a continuous process not related to time of day. Items heat up because they are absorbing more heat than they are radiating. The hotter they get the more they radiate heat. High emissivity is important when the sun is shining on a roof. If a 'black body' has a reflectivity of '0' and an emissivity of '1' it will not heat above the ambient temperature.

³ Cool Colors Project: Improved Materials for Cooler Roofs, Oak Ridge National Laboratory (ORNL) and Lawrence Berkeley National Laboratory (LBNL). Accessed Dec. 12, 2008 from <http://eetdnews.lbl.gov/nl19/cool.htm>

Solar reflectance is the most important characteristic of a roof product in terms of yielding the highest energy savings during warmer months. The higher the solar reflective value, the more efficient the product is in reflecting sunlight and heat away from the building and reducing roof temperature. This is particularly important in warm areas where peak load is a concern.

In warm and sunny climates, highly emissive roof products can help reduce the cooling load on the building by releasing the remaining heat absorbed from the sun. On the other hand, there is also evidence that low emissivity may benefit those buildings located in colder climates by retaining heat and reducing the heating load. Research on the benefits of emissivity is ongoing. Discuss reflectance and emissivity with the roofing supplier or contractor to determine what characteristics matter most given the unique local situation.

ENERGY STAR Requirements

ENERGY STAR qualified roof products must meet minimum initial and aged solar reflectance values. Emissivity is not currently a requirement for ENERGY STAR qualification. However, EPA began posting emissivity values for all products on the ENERGY STAR Qualified Products List on December 31, 2007 to assist consumers in their purchasing decision. Longer term, EPA plans to revisit the possibility of adding an emissivity component to the ENERGY STAR specification.

Materials

Climate and techniques of installation are two factors which will lead to success or failure of our roofing choices. Please be sure to consider them. Shingles which may often fail in our climate have been identified the hard way. For example, split-cedar wood “shakes” which look great and may work well in Oklahoma or New England fail prematurely in Louisiana.

Roof Slopes

The manufacturer of shingles usually specifies a minimum slope for which they will warrant their product. For composition shingles (asphalt composition) and fiberglass composition shingles, that minimum slope is usually 3:12. Some will warrant this low slope if two layers of asphalt saturated felt (so called “tar paper”) are used as underlayment. It is a good idea in Louisiana to get the water off the roof quickly. Increased slope of the roof minimizes the wind being able to blow water under shingles or particularly under flashing. For slopes 3:12 or less one should consider one of the types of metal roofs such as standing seam, or lock seam. When the slope is even less like 1/2:12 or 1/4:12, a membrane type roof is a better choice. The membrane roof, often referred to as a “low slope roof,” is available in PVC, EDPM, Modified Bitumen, or asphaltic built up roof (BUR) (see below).

Composition Shingles (also called asphalt shingles)

Composition shingles are either organic-based or fiberglass-based. Fiberglass shingles are more flexible and durable than organic. Fiberglass composition shingles are made of tiny glass fibers of varying lengths and then covered with a layer of asphalt and weather-resistant mineral granules. In 2009 Energy Star certifies several brands of shingle roofs in white and 4 colors.

- Strip Shingles – These are made to be three times as long as they are wide. These are distinguished by the number of tabs they have. The most common type of strip shingle is the “three-tab” shingle. Different textural and lighting/shadowing effects can be achieved with strip shingles depending on the number, shape and alignment of the cutouts.

- **Laminated Shingles** - These special shingles contain more than one layer of tabs to create extra thickness. They are also referred to as three-dimensional or architectural shingles because they create visual depth on a roof and impart a custom look. Laminated shingles are a favorite among builders, roofing contractors and homebuyers. They weigh about 350 pounds per square, or about 3.5 pounds per square foot.
- **Interlocking Shingles** - As the name suggests, interlocking asphalt shingles are individual shingles that mechanically fasten to each other, and are used to provide greater wind resistance. They come in various shapes and sizes providing a wide range of design possibilities. These shingles are not available everywhere, but they are specially shaped to “hook” on to the course below to provide uplift resistance.

**Figure 10-2
Laminated Shingles**

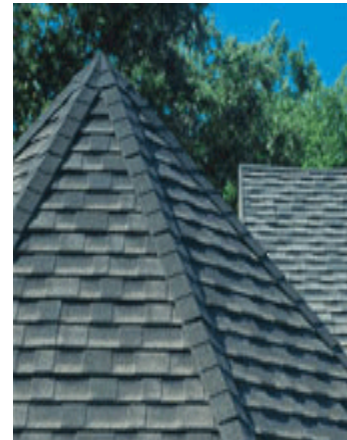

Clay Tiles

This ancient material is split from clay and formed into special interlocking thin sheets of ceramic. Then cut to length and width, and finally drilled for nail penetrations. They are an outstanding example of thermal mass which gathers heat from the sun and reradiates it at night into the space.

Slate Tile Shingles

Traditionally slate roofing tiles were cut and sized by hand, but now manufacturers pre-cut the slate roofing tile with a machine to assure exact measurements. Nail holes are also pre-drilled and countersunk to speed construction and repair. Countersunk holes allow the roof tile to lie flat for longest possible lifetime. A stronger roof structure is needed to withstand the weight of slate roofing material; therefore many manufacturers require an architect's recommendation on each property prior to installation of natural slate roofs. There are other alternatives to natural slate which are considered below.

**Figure 10-3
Natural Slate Tiles**



Concrete Tile Shingles

Concrete tiles are very wind-resistant, long-lasting, energy efficient and fire-resistant. They can be cast and dyed to look like slate or clay tile. Their weight does require a stronger roof deck and structure. The vented voids of the “S” tile cool the space above the roof deck through natural ventilation at the eave. The heat buildup is removed at the ridge before it can move into the attic.

Both Concrete tile types absorb condensation at night and cool by evaporation until dry during the morning.

Figure 10-4
Concrete Tiles



Concrete "S" Tile



Concrete Flat "slate" Tile

Rubber Shingles

These shingles are made from recycled automobile tires and can simulate the look of slate or wood shakes with relatively low weight. They are also hail resistant.

Figure 10-5
Rubber Shingles



Metal Roofing

EPA's Energy Star certifies many metal roofing products. According to Energy Star data, coated metal roofs generally have many advantages:

- Energy Star-rated, coated metal roofs have a high reflectance and a high emissivity. The former helps reflect infrared energy back to the sky before it can penetrate the structure, and the latter helps rapidly cool the metal by releasing absorbed energy to the night sky.
- Metal roofing is long lasting: 30 years or more with minimal maintenance.
- Metal roofing is environmentally friendly and is 100% recyclable.
- The recycled content is between 25% and 80%, depending on the steel or aluminum making process.
- A lightweight metal roof can be installed over an existing roof saving removal and landfill costs.
- Metal roofing readily adapts to photovoltaic installations.
- Metal roofing can reduce energy consumption and with cool roof coating properties it can reduce heat transfer through the roof.
- Several methods of insulating are available, to nearly any R factor.
- Forms can vary from shingles, "tiles," corrugated sheets, or a variety of standing seams.

- Materials are copper (expensive), coated or uncoated aluminum, galvanized (zinc-coated) steel, aluminized steel and galvalume (55% zinc, 45% aluminum alloy-coated steel).
- The better coatings have a twenty to fifty year warranty. Kynar 500 and Hylar 5000 are trade names for two of these fluropolymer coatings.

Table 10-3
Characteristics of Various Metal Roof Types Ranked by Reflectance⁴

Company	Brand	Model	Initial Solar Reflectance	Initial Emissivity	Low Slope?	Steep Slope?	Warranty (Years)
Metals USA Building Products	Allmet	Autumn Gold	0.93	0.94	N	Y	Ltd. Lifetime
Millennium Metals Inc.	CERAM-A-STAR	Polar White	0.85	0.88	Y	Y	40
Kirby Building Systems Inc.	Kirby-Cool	815W49	0.77	0.85	Y	Y	35
Petersen Aluminum, Corp.	PAC-CLAD	Bone White 431X471	0.73	0.85	Y	Y	20
Metal Sales Mfg. Corporation	PVDF	Linen White	0.73	0.86	Y	Y	45
Firestone Bldg. Products	Bone White SR (Steel)	UC-11,UR,VR,600,601,700,5VC,NB1,NB2	0.72	0.84	N	Y	20
Metal Sales Mfg. Corporation	PVDF	Sierra White	0.72	0.85	Y	Y	45
Central States Mfg., Inc.	CentralGuard	SPW 0295X	0.71	0.85	Y	Y	40
ATAS International, Inc.	ATAS Bone White, ATAS #26	PC Panel Standing Seam, and Castletop Shingle HCT	0.70	0.87	Y	Y	30
Drexel Metal Corporation	Regal White	DMC 100NS	0.70	0.87	N	Y	35
Merchant and Evans, Inc.	Zip Rib	Standing Seam Regal White SR	0.70	0.85	Y	Y	30
Interlock Roofing Ltd.	Alunar	Bone White #40	0.69	0.87	N	Y	40
Fabral	Architectural Profiles	Regal White V38	0.68	0.89	N	Y	20
McElroy Metal, Inc.	Regal White	Medallion-Lok, Medallion I & II, Maxima, ML-90, Mirage, Meridian	0.68	0.86	Y	Y	40
Alliance Steel, Inc.	ASI	Exposed Fastener Roof Profiles	0.68	0.84	Y	Y	20
Butler Mfg. Company	Butler	MR-24	0.68	0.86	Y	Y	20
Corrugated Ind. of FL, Inc.	Galvalume Plus	Galvalume Plus	0.68	0.86	Y	Y	25
Custom Metal Bldg. Products	Galvalume Plus	Galvalume Plus	0.68	0.87	Y	Y	25
Classic Metal Roofing System	Great American Shake	4001 White	0.68	0.85	N	Y	40
LifeTite Metal Products LLC	Lifetite Metal Products	Polar White	0.67	0.87	Y	Y	40
McElroy Metal, Inc.	Ivory	Max-Rib, Multi-Rib, R-Panel, Mega-Rib, Corrugated, U Panel	0.67	0.87	Y	Y	40

⁴ Source: Extracted from www.energystar.gov – metal roof characteristics out of 1200+ products

Low Slope Roofs

For low slope roofs (so-called “flat roofs”) the roofing manufacturer will not usually warrant the roof membrane unless the roof deck has a minimum slope of ¼” per foot of run. This is to minimize ponding of water which may cause deterioration of the membrane. For this type of roof, a membrane system is applicable. From an energy conservation standpoint, the membrane is almost always applied over insulation which may be flat on a sloped roof deck, or may be tapered to provide the required slope on a flat roof deck. By including the insulation over the roof deck energy conservation performance is far more effective than if the insulation were placed between the roof joists below the roof deck. The former insulation is continuous and the latter is cavity. Continuous insulation has a uniform R-factor everywhere, whereas cavity insulation R value is a mix of the area weighted average of the R-factor of the joist (low R-factor) and the R-factor of the insulation, which is interrupted at each joist.

Membrane roofs fall into the following categories: Built-up roofs (BUR); single- or multi-ply roofs, which often may have a base sheet and a cap sheet (so may be considered 2 or 3 ply roofs). The generic classes of membrane types are asphalt hot-mopped over organic or fiberglass felt, which is unrolled from rolls during the installation. They overlap at the edges and are installed in multiple layers. One of the best membrane roofs was the coal tar pitch built-up roof. Installation was very labor intensive and it was self-healing in hot weather. These roofs often lasted for 50 plus years without problems or failures. Unfortunately, today’s economy doesn’t tolerate labor intensive work because of the cost. A further blow to this type of roof was that the coal tar pitch was determined to be a carcinogen. Thus, these gravel topped roofs have largely been replaced by the “single” ply roofs. These roofs are made from PVC, or EDPM (rubber), or modified bitumen which is either hot mopped or torched applied. Each has different properties which make it appropriate for a particular application.

Modified Bitumen Roofing

APP (Atactic Polypropylene): Prior problems with coal tar pitch roofs were caused when they became inflexible in cold weather, causing them to crack and fissure. The modified bitumen roofs today are chemically designed to eliminate this to a large degree. There are several varieties of an APP-modified bitumen sheet, which incorporate the features of a tough, non-woven, polyester mat saturated and coated with a blend of APP polymer and high quality asphalt. Low temperature flexibility is maintained to 14°F (-10°C). The APP is a waste product from the manufacture of polypropylene and found a productive recycled use in this type of roof.

SBS (Styrene-Butadiene-Styrene): Even more resilient is another type of modified bitumen sheet incorporating the features of a strong fiber glass mat with a blend of SBS rubber, high-quality asphalt and fire-retardant additives. The elastomeric asphalt blend has full recovery properties after 100% elongation and provides elasticity and flexibility to the sheet. Low temperature flexibility is maintained to -10°F (-23°C).

Rubber Membrane

EPDM (Ethylene Propylene Diene Monomer) Rubber: EPDM is a flexible, black roofing membrane available in .045 inch, .060 inch, and .090 inch thicknesses. Due to its superior flexibility and strength, EPDM can easily contour to unusual roof shapes. A white-coated EPDM has been installed on RV's since 1983. Advantages are low maintenance, ease of repair, clean appearance, noise reduction, and thermal insulation. Now the energy efficiency of white on black EPDM is available

for all sorts of roofs. It is sold in sheets up to 50’ wide and 100’ long. It can be seamed for wider applications. It is typically held down by mechanical fasteners or ballasted with gravel.

Hypalon® (chlorosulfonated polyethylene): Made in Louisiana by DuPont, this material has demonstrated long life in harsh environments since 1957. It is thermoplastic enabling welding by hot air or solvents. Once installed the Hypalon® polymer slowly cures in place to reach its final mechanical properties.

TPO (Thermoplastic polyolefin): TPO is a generic group of chemicals. White and some colored TPO roofing membranes meet Energy Star Roof Requirements.

PVC (polyvinylchloride): This membrane material is often bright white and is highly reflective, making it a very energy efficient roofing choice. It is most often adhered as a single-ply membrane to the roof deck or insulation, or mechanically fastened. Joints are glued at the head and side lap. The material can be heat welded.

**Table 10-4
Cool Roof Rating Council Top Rated Membrane Products Typical Properties⁵**

(CRRC) Material	Reflectance		Emissivity	
	Initial	Weathered	Initial	Weathered
PVC	0.87	0.61	0.95	0.86
Hypalon	0.85	0.69	0.87	0.82
Modified Bitumen	0.79	0.68	0.87	0.75
TPO	0.79	0.70	0.90	0.86
EPDM	0.76	0.64	0.90	0.87

Attic Ventilation

What is the purpose of attic ventilation? Attic ventilation has been traditional in residential (wood frame) construction. If water enters the attic due to roof leaks, condensation, spills, or other means, it must have a way to dry out or the structure will suffer damage. The air introduced by soffit vents and expelled through ridge, gravity or turbine vents allow air to circulate through the attic. This assists in keeping the attic air circulating, able to remove moisture from the attic. Another primary reason for this ventilation in the South has been to help reduce the very high attic temperature which builds up in the summer. Actually, this benefit turns to a detriment in winter. With a cold attic gaining heat from the house, attic air circulation accelerates the heat lost from the living space. This is actually efficient in summer, and inefficient in winter.

One of the best arguments for insulating and sealing an attic space is the large reduction in attic temperature. Now that the roof rafters are insulated, the attic temperature buildup is slowed down. Due to less heat from the attic flowing into the conditioned house, the house and the sealed attic are both cooler than the house with the ventilated attic in summer. The sealed attic is also far warmer in winter as the heat flow reverses from house to attic. Why is this so beneficial? In today’s typical house, the ducts, if not the entire HVAC (heating ventilating and air conditioning) system, are located in the attic. The homeowner first pays to cool air from the living space, and then send it

⁵ Source: <http://www.coolroofs.org/products/search.php> accessed 5 Nov. 2008

through (nominally R-6) insulated attic ductwork across the attic where it may be as hot as 130°-150°F. The heat, which has been removed from the air, is regained through the duct material on the air's journey through the attic ducts. The fan propels the air through the coil, plenum and air ducts in the attic continuously, where the attic heats it prior to reaching the living space. This is far from efficient.

In a sealed attic, the insulation is placed between or above the sloped rafters, rather than between the horizontal ceiling joists (attic floor joists). This retards heat from the sun in penetrating the house envelope at the roof. The attic volume becomes semi-conditioned space. Semi-conditioned space is adjacent to conditioned space, but has no (or less than optimal) supply air registers present. Much like a closet within the envelope, the attic is not directly air conditioned, but loses or gains heat from adjacent conditioned spaces which moderate the temperature within. Compared to a ventilated attic which may be as hot as 140°F in summer, the sealed semi-conditioned attic space may be more like 75-85°F in summer. The supply air duct heat gain from the attic is reduced. Without insulation on the floor of the attic, heat flows from the semi-conditioned attic to the conditioned space where the slightly warmer air is mixed with cooled air. In winter, heat easily flows up into the semi-conditioned attic, keeping it warmer and thereby protecting any pipes that are located there. In winter, heat loss through the roof to the exterior is retarded by the roof deck insulation.

Another large energy saving from an insulated attic is related to air conditioning. A supply leak in the ductwork in a ventilated attic can waste large amounts of cooled air. Not only is this expensive, but when the cool air from the supply duct hits the very hot attic air, we introduce a water problem into the attic through condensation increasing the potential for mold and mildew growth from the water in a wood structure. This can be a big efficiency and maintenance problem.

If, on the other hand, there is a return air duct leak from the attic, hot air is sucked into the coil, and into supply air stream. If the attic were insulated, sealed, and at the far lower (semi-conditioned) temperature, a supply duct leak would only be another useful but unintended supply air register. The return leak may add a little extra heat into the air stream, but would not have the devastating effect on the energy use or monthly bill. Of course neither leak type would be conducive to the lowest possible utility bill. Therefore, in all spaces, it is extremely important to properly seal duct leaks with fiberglass tape, coated with duct-sealing mastic.

Attic Vents - common mistakes:

Vented attics are still the norm and required by some building officials. Proper use of ventilation products is important. Too many times, homeowners install products that short-circuit their ventilation system. When designing a ventilation system, avoid these common pitfalls:

- Using a combination of different types of exhaust vents, such as power vents with ridge vents where competing vents pull air from each other, instead of from the soffit vents.
- Underestimating your ventilation needs. Remember that 11 louvered type roof vents or five turbine vents would be needed to provide the same ventilation as a ridge vent installation on a gable roof.
- Installing exhaust vents without adequate intake. An effective balance of intake and exhaust must be achieved to properly ventilate your home. The flow of air in your attic is limited to the amount of intake or conditioned air will be pulled from the house.
- Installing a ridge vent that doesn't have an external baffle to increase air flow and protect from weather infiltration.

Green Roofs

NRCA (National Roofing Council of America) is beginning to use the term “landscaped roof systems” in lieu of “green roof systems” to prevent confusion in the building industry. Landscaped roof systems require a combination of roofing concepts and waterproofing concepts. A landscaped roof system is a wet environment and a waterproofing membrane is mandatory. Roof system details are modified to accommodate growth medium and green components. On a typical low slope roof, the insulation would be found under the water proof membrane. NRCA recommends a waterproofing membrane be adhered with insulation above it. Therefore, a landscaped roof system membrane is thermally stabilized and protected from damage and puncture by the insulation itself. However in the case of Green or “landscaped roofs, the turf or planting will be at the surface, with soil drainage created by crushed stone or gravel below the plants, but above the rigid insulation which sits on top of the waterproof membrane at the lowest level. Positive drainage is strongly recommended. Water must be free to drain from all of the planted area, to collect at common points, and to be directed away from the building. There may be other areas designed specifically to hold the water for use by the planting. The idea of these roofs is illustrated below:

**Table 10-5
Advantages and Disadvantages of Green Roofs**

Advantages of Green Roofs	Disadvantages of Green Roofs
Environmentally friendly.	Increased roof weight may require increased structural member sizes and cost.
Can create usable outdoor space.	Safety/liability may be an issue for public access.
Increase thermal efficiency of the building.	
Reduces HVAC equipment and operating cost.	
Reduces interior noise levels.	
Extends roof membrane service life.	If a roof membrane leak does occur, it may be difficult to locate.
Provides storm-water management, aesthetic benefits, rating system benefits (e.g., LEED™ and Green Globes).	Cost to repair roof and then to replace living flora and soil above may be very high by comparison.
Reduces rooftop temperatures.	
Mitigates urban heat islands.	
Improves, urban air quality, wildlife habitats, community green space.	

The 2007 edition of the NRCA Green Roof Systems Manual has much more detail. Also NRCA University’s Roofing 101 program offers an interactive, cost-effective online training tool to learn roofing fundamentals. Go to www.nrca.net for a link to Roofing 101.

Figure 10-6
Landscaped “Green Roof”



This landscaped roof is over the east addition to the Louisiana State Capitol. The subterranean space below grade functions as the House of Representative’s Committee Rooms. A similar addition on the west side is over the Senate Committee Rooms. The difficulty of aesthetically matching this 1937 high rise historical structure with flanking additions played a role in making the additions below grade. The energy savings and creation of public spaces were also a benefit.

To Top It OFF

The roof receives the most solar radiation of any building component under normal circumstances. A Louisiana home owner can save money while helping the environment by having a cool roof color (CRC) on Energy Star Approved metal panels, CRCM covered shingles or other high-reflectance, high-emissivity roof. A sealed attic can provide even more help. Wise use of shade trees can help inside and out. The goal is to keep the sun’s heat from entering the conditioned space rather than admit it and then have to remove it through air conditioning. It is this kind of thinking about how heat flows and where it can be blocked or slowed down that will lead to advances in energy efficiency in the 21st Century.

Notes:

Chapter 11

Fingertip Facts

This fact sheet contains statistical energy information-conversion factors, R-values, fuel prices, energy efficiency recommendations, and climatic data for Louisiana. It serves as a reference guide for those seeking a quick answer to an energy question.

Abbreviations

Btu	British Thermal Unit, the amount of heat needed to increase the temperature of one pound of water one degree Fahrenheit (about the amount of heat released when a kitchen match burns)		
1° F	one degree Fahrenheit	cf	cubic foot
MMBtu	one million Btu	cfm	cubic foot per minute
kWh	kilowatt-hour	bbl	barrel
kW	kilowatt	gal	gallon

Energy and Fuel Data

Energy Units

1 kWh = 3,412 Btu
1 MMBtu = 293 kWh
1 Btu = 252 calories
1 Btu = 1,055 joules

Power Units

1 kW = 3,412 Btu/hour
1 horsepower = 746 watts
1 ton of heating/cooling = 12,000 Btu/hour

Fuel Units

1 cf of natural gas \approx 1,000 Btu
1 therm = 100,000 Btu
1 bbl fuel oil = 42 gallons = 5.88 MMBtu
1 ton fuel oil = 6.8 bbl
1 gallon fuel oil = 136,000 Btu
1 gallon of propane = 91,500 Btu
1 ton bituminous (Eastern) coal = 21-26 MMBtu
1 ton subbituminous (Western) coal = 14-18 MMBtu
1 cord wood = 128 cubic feet (4 ft x 4 ft x 8 ft)
1 cord dried pine = 14.2 MMBtu

Average Daily Solar Radiation

(Btu/sq ft on a Vertical, South-Facing Surface)

	Latitude	January	July
Baton Rouge	30.5	889	786
Lake Charles	30.1	790	795
New Orleans	30.0	950	801
Shreveport	32.5	920	804

Insulating Values

The R-value is the measure of resistance to heat flow via conduction. R-values vary according to specific materials and installation.

<i>Insulation</i>	<i>R-value per inch</i>
Fiberglass batts/rolls	3.1 to 4.3
Fiberglass loose-fill	2.2 to 2.6
Rock wool loose-fill	2.6
Cellulose	3.7
Vermiculite	2.1
Perlite	3.3
<i>Rigid Insulation Boards</i>	<i>R-value per inch</i>
Fiberboard sheathing (non-insulating blackboard)	2.6
Expanded polystyrene (beadboard)	4.0
Extruded polystyrene	5.0
Polyisocyanurate and polyurethane	6.8 to 7.2
<i>Building Materials</i>	<i>R-value per inch</i>
Drywall	0.9
Wood siding	0.9 to 1.2
Common brick	0.2
Lumber and siding	
Hardwood	0.8 to 0.94
Softwood	0.9 to 1.5
Plywood	1.3
Particle Board (medium density)	1.1
Asbestos-cement (entire shingle)	0.21
Concrete block (entire block)	
Unfilled	0.4 to 1.2
Filled with vermiculite/perlite	1.3 to 2.0
Filled with cement mortar	0.2
<i>Dead Air Spaces</i>	<i>R-value of air space</i>
1/2-inch	0.75
3/4-inch	0.77
3-1/2-inch	0.80
3-1/2-inch, reflecting surface on one side	1.6
3-1/2-inch, reflecting surface both sides	2.2
<i>Air Films</i>	<i>R-value of air film</i>
Still air (vertical wall)	0.68
15 mph wind (winter)	0.17
7.5 mph wind (summer)	0.25

HVAC Equipment Efficiencies

Annual Fuel Utilization Efficiency (AFUE) shows the average annual efficiency at which fuel-burning or electric resistance furnaces operate.

Coefficient of Performance (COP) measures how many units of heating or cooling are delivered for every unit of electricity used in a heat pump or air conditioner.

Heating Season Performance Factor (HSPF) measures the average number of Btu of heating delivered for every watt-hour of electricity used by a heat pump.

Seasonal Energy Efficiency Ratio (SEER) measures how readily air conditioners convert electricity into cooling—a SEER of 10 means the unit provides 10,000 Btu's of cooling per kilowatt-hour of electricity.

Ranges of Efficiency	Low	Moderate	High
Gas furnaces (AFUE)	0.78	0.80	0.95
Air conditioning (SEER)	10	13	15
Heat Pump (HSPF)	6.8	7.2	8.0

Climatic Data for Louisiana

Heating Degree Days (HDD) are a measure of how cold a location is in winter. Heating degree days are calculated by multiplying the difference in temperature below 65°F by the amount of time at that temperature. For example, if the temperature were 41°F for 10 hours, it would mean 10 heating degree days: $(65^{\circ}\text{F} - 41^{\circ}\text{F}) * (10 \text{ hrs}) / (24 \text{ hrs per day})$.

Cooling Degree Days (CDD), are a measure of how hot a location typically is during summer. They are calculated similarly to heating degree days, but for temperatures above 65°F. For example, if the temperature were 89°F for 6 hours, it would mean 6 cooling degree days: $(89^{\circ}\text{F} - 65^{\circ}\text{F}) * (6 \text{ hrs}) / (24 \text{ hrs per day})$.

Winter and Summer Design Temperatures should be used by heating and cooling contractors when sizing heating and cooling systems. They show the temperatures that are exceeded in summer or dipped below in winter only **2.5% of the time**.

**Table 11-1
Climatic Data for Louisiana**

Location	Winter Design Temperature	Heating Degree Days	Summer Design Temperature	Cooling Degree Days
Alexandria	27	2066	94	2991
Baton Rouge	29	1526	93	3275
Lafayette	30	1547	94	3238
Lake Charles	31	1646	93	3095
Monroe	25	2484	96	2754
New Orleans	33	1374	92	3213
Shreveport	25	2286	96	2974

**Table 11-2
Average Monthly Temperatures**

	Baton Rouge	Lake Charles	New Orleans	Shreveport
JAN	50.1	50.9	52.6	46.4
FEB	53.5	54.4	55.7	51.2
MAR	60.3	61.0	62.4	58.5
APR	66.6	67.3	68.2	65.2
MAY	74.0	74.9	75.6	73.0
JUN	79.7	80.5	80.7	79.9
JUL	81.7	82.6	82.7	83.4
AUG	81.4	82.4	82.5	82.9
SEP	77.5	78.4	78.9	77.0
OCT	68.1	69.5	70.0	66.7
NOV	59.0	60.1	61.4	56.1
DEC	52.4	53.3	55.1	48.4
YEAR	67.1	68.0	68.9	65.8

Table 11-3
Comparative Climatic Data
***For February 2006 through February 2009**

Location	Average Temperature	*Heating Degree Days	*Cooling Degree Days
Honolulu, HI	77	11	4,746
Miami, FL	76	182	4,791
Brownsville, TX	74	707	4,396
Houston, TX	69	1,561	3,459
Tucson, AZ	68	1,969	3,390
Mobile, AL	67	1,894	2,867
Jackson, MS	65	2,434	2,788
Birmingham, AL	62	2,902	2,535
Atlanta, GA	61	3,721	2,099
Memphis, TN	62	3,222	2,650
New York, NY	55	5,007	1,258
Washington, DC	54	4,274	1,804
Chicago, IL	51	6,539	1,189
Glasgow, MT	42	9,100	941
Fargo, ND	41	9,622	826
Caribou, ME	39	9,974	351
International Falls, MN	37	11,169	418
Fairbanks, AK	20	14,746	159

Notes:

Glossary

Absolute Humidity - Air moisture content expressed in grains (or pounds) of water vapor per pound of dry air.

Absorptance - The ratio of the radiation absorbed by a surface to the total energy falling on that surface described as a percentage.

Active Solar Energy - Solar radiation used by special equipment to provide space heating, hot water or electricity.

Air Barrier - Any part of the building shell that offers resistance to air leakage. The air barrier is effective if it stops most air leakage. The primary air barrier is the most effective of a series of air barriers.

Air Change - The replacement of a quantity of air in a space within a given period of time, typically expressed as air changes per hour. If a building has one air change per hour, this is equivalent to all of the air in the building being replaced in a one-hour period.

Air Changes At 50 Pascals - The number of times that the complete volume of a home is exchanged for outside air when a blower door depressurizes the home to 50 pascals.

Air Conditioner - An assembly of equipment for air treatment consisting of a means for ventilation, air circulation, air cleaning, and heat transfer (either heating or cooling). The unit usually consists of an evaporator or cooling coil, and an electrically-driven compressor and condenser combination.

Air Film - A layer of air adjacent to a surface which provides thermal resistance.

Air Film Coefficient - A measure of the heat transfer through an air film.

Air Handler - A steel cabinet containing a blower with cooling and/or heating coils connected to ducts.

Air-to-Air Heat Exchanger - A device with separate air chambers that transfers heat between the conditioned air being exhausted and the outside air being supplied to a building.

Ambient Air Temperature - Surrounding temperature, such as the outdoor air temperature around a building.

Ambient Lighting - Lighting spread throughout the lighted space for safety, security, and aesthetics.

Alternating Current (AC) - Flow of electricity that constantly changes direction between positive and negative sides. Almost all power produced by electric utilities in the United States moves in current that shifts direction at a rate of 60 times per second.

Ampere (Amp) - The unit of measure that tells how much electricity flows through a conductor. It is like using cubic feet per second to measure the flow of water. For example, a 1,200 watt, 120-volt hair dryer pulls 10 amperes of electric current (watts divided by volts).

Angle of Incidence - The angle that the sun's rays make with a line perpendicular to a surface. The angle of incidence determines the percentage of direct sunshine intercepted by a surface.

AFUE (Annual Fuel Utilization Efficiency) - A measure of heating efficiency, in consistent units, determined by applying the federal test method for furnaces. This value is intended to represent the ratio of heat transferred to the conditioned space by the fuel energy supplied over one year.

ASHRAE - Acronym for American Society of Heating, Refrigerating and Air- Conditioning Engineers.

Backdraft Damper - A damper, installed near a fan, that allows air to flow in only one direction.

Backdrafting - Continuous spillage of combustion gases from a combustion appliance.

Backer Rod - Polyethylene foam rope used as a backer for caulking.

Baffle - A plate or strip designed to retard or redirect the flow of gases.

Ballast - A device that provides starting voltage and limits the current during normal operation in electrical discharge lamps (such as fluorescent lamps).

Band Joist - See Rim joist.

Batt - A narrow blanket of fiberglass insulation, often 14.5 or 22.5 inches wide.

Beam - A strong horizontal building support used to carry the weight of a floor or roof.

Bimetal Element - A metal spring, lever, or disc made of two dissimilar metals that expand and contract at different rates as the temperature around them changes. This movement operates a switch in the control circuit of a heating or cooling device.

Black Body - A (theoretical) material that absorbs all radiation that hits it. It has an emissivity of 100% or 1.0. Black bodies are used by thermal imaging camera manufacturers to calibrate their temperature measuring cameras.

Blower - The fan in a furnace or air handler, typically a squirrel-cage type fan.

Blower Door - A device that consists of a fan, a removable panel, and gauges used to measure and locate air leaks.

Boot - A duct section that connects between a duct and a register.

British thermal unit (Btu) - The standard measure of heat energy. It takes one Btu to raise the temperature of one pound of water by one degree Fahrenheit at sea level. For example, it takes about 2,000 Btu to make a pot of coffee. One Btu is equivalent to 252 calories, 778 foot-pounds, 1055 joules, and 0.293 watt-hours. Note: In the abbreviation, only the B is capitalized.

Btuh - British thermal units per hour.

Building Cavities - The spaces inside walls, floors, and ceilings between the interior and exterior sheeting.

Building Envelope - The assembly of exterior partitions of a building which enclose conditioned spaces, through which thermal energy may be transferred to or from the exterior, unconditioned spaces, or the ground.

Building Science - A branch of science dealing with construction, maintenance, safety, and the energy efficiency of buildings.

Calorie - (energy calorie - small "c" - as opposed to food Calorie - capital "C") Any of several approximately equal values of heat, each measured as the quantity of heat required to raise the temperature of 1 gram of water by 1 degree Celsius from a standard initial temperature, esp. from 3.98° Celsius, 14.5° Celsius, or 19.5° Celsius, at 1 atmosphere pressure. A calorie is the unit of heat equal to 4.184 joules. One food calorie equals 1,000 energy calories.

Capillary Action - The ability of water to move through materials, even upward against gravity, through small tubes or spaces.

Capillary Barrier - A material or air space designed to stop capillary action from carrying water into a building.

Carbon Dioxide (CO₂) - A colorless, odorless, non-poisonous gas that is a normal part of the air. Carbon dioxide, also called, is exhaled by humans and animals and is absorbed by green growing things and by the sea.

Carbon Monoxide (CO) - A colorless, odorless, highly poisonous gas made up of carbon and oxygen molecules formed by the incomplete combustion of carbon or carbonaceous material, including gasoline. It is a major air pollutant on the basis of weight.

Caulking - Material used to make an air-tight seal by filling in cracks, such as those around windows and doors.

Cellulose Insulation - Insulation, packaged in bags for blowing, made from newspaper or wood waste and treated with a fire retardant.

Centigrade - See Celsius

Celsius - A temperature scale based on the freezing (0°C) and boiling (100°C) points of water. Abbreviated as C in second and subsequent references in text-formerly known as Centigrade.

CFM50 - The number of cubic feet per minute of air flowing through the fan housing of blower door when the house pressure is 50 pascals (0.2 inches of water). This figure is the most common and accurate way of comparing the air tightness of buildings that are tested using a blower door.

Chiller - A device that cools water, usually to between 40 and 50 degrees Fahrenheit for eventual use in cooling air.

Circuit - One complete run of a set of electric conductors from a power source to various electrical devices (appliances, lights, etc.) and back to the same power source.

Circuit Breaker - A device that disconnects an electrical circuit from electricity when it senses excessive current.

Clerestory - A wall with windows that is between two different (roof) levels. The windows are used to provide natural light into a building.

COP (Coefficient of Performance) - Used to rate the performance of a heat pump, the COP is the ratio of the rate of useful heat output delivered by the complete heat pump unit (exclusive of supplementary heating) to the corresponding rate of energy input, in consistent units and under specific conditions.

Coil - A piece of copper tubing through which a working fluid passes in order to transfer heat to a second medium (air, water, or soil). The coil may be surrounded by rows of aluminum fins that clamp tightly to the tubing in order to aid in heat transfer.

Color Temperature - A measurement of the color of light provided by a light source. The color temperature is determined by the temperature, in Kelvin, at which an ideal black body emits light of the same color.

Color Rendering Index - A measurement of a light source's ability to render colors the same as sunlight. CRI has a scale of 0 to 100. A lower CRI means that some colors will not appear as vibrant as in natural sunlight.

Combustion - Rapid oxidation, with the release of energy in the form of heat and light.

Combustion Analyzer - A device used to measure steady-state efficiency of combustion heating units.

Combustion Chamber - The area inside the heat exchanger where the flame burns.

Combustion Efficiency - A simple measure of the heating efficiency of a boiler. It is equal to 100 percent minus the percentage of heat lost up the vent (called "flue loss" or "stack loss").

Commissioning - The process of testing and adjusting building mechanical systems after building construction or as a retrofit measure.

Comfort Zone - The range of temperatures over which the majority of persons feel comfortable (neither too hot nor too cold).

Condensate - Liquid formed by condensing vapor.

Condense - When a gas turns into a liquid as it cools, we say it condenses. Condensation is the opposite of evaporation.

Condenser - A heat exchanger in which the refrigerant, compressed to a hot gas, is condensed to liquid by rejecting heat.

Conditioned Space - Enclosed space that is either directly conditioned space or indirectly conditioned space.

Conductance – A measure of the ability of a material to transfer heat. Typically, it is the quantity of heat, in Btu's, that will flow through one square foot of material in one hour, when there is a 1 degree F temperature difference between both surfaces. Conductance values are given for a specific thickness of material, not per inch thickness.

Conduction - The transfer of heat energy through a material (solid, liquid or gas) by the motion of adjacent atoms and molecules without gross displacement of the particles.

Conductivity (*k*) - The quantity of heat that will flow through one square foot of homogeneous material, one inch thick, in one hour, when there is a temperature difference of one degree Fahrenheit between its surfaces.

Convection - Heat transfer by the movement of fluid.

Conventional Gas - Natural gas occurring in nature, as opposed to synthetic gas.

Cooling Capacity, Latent - Available refrigerating capacity of an air conditioning unit for removing latent heat from the space to be conditioned.

Cooling Capacity, Sensible - Available refrigerating capacity of an air conditioning unit for removing sensible heat from the space to be conditioned.

Cooling Capacity, Total - Available refrigerating capacity of an air conditioner for removing sensible heat and latent heat from the space to be conditioned.

Cooling Degree Day - A unit of measure that indicates how heavy the air conditioning needs are under certain weather conditions.

Cooling Load - The rate at which heat must be extracted from a space in order to maintain the desired temperature within the space.

Cooling Load Temperature Difference (CLTD) - A value used in cooling load calculations for the effective temperature difference (ΔT) across a wall or ceiling, which accounts for the effect of radiant heat as well as the temperature difference.

Cord - A measure of volume, 4 by 4 by 8 feet, used to define amounts of stacked wood available for use as fuel. Burned, a cord of wood produces about 5 million calories of energy.

Cubic Foot - The most common unit of measurement of natural gas volume. It equals the amount of gas required to fill a volume of one cubic foot under stated conditions of temperature, pressure and water vapor. One cubic foot of natural gas has an energy content of approximately 1,000 Btus. One hundred (100) cubic feet

Curtain wall: A wall between columns and beams that supports no weight but its own.

CFM (cubic feet per minute) - A measure of flow rate.

Daylighting - The use of sunlight to supplement or replace electric lighting.

Daylighting Control - A control system that varies the light output of an electric lighting system in response to variations in available daylight.

Degree Days - A measure of the temperature element of climate produced by multiplying temperature difference by time.

Delta - A Greek letter used as a mathematical term meaning the difference in one thing and another. Also it is called the remainder of a subtraction problem between two numbers. Often used in the context of the difference between the temperature of one area and another.

Demand – Power consumption.

Density - The mass per volume of a substance.

Depressurize - Cause to have a lower pressure or vacuum with respect to a reference of a higher pressure.

Desiccant - A liquid or solid material used to absorb water or water vapor.

Design Temperature - A high or low outdoor temperature used for designing heating and cooling systems.

Desuperheater - A heat exchanger that removes the superheat from a compressed refrigerant and transfers that heat to another fluid, usually water.

Dew Point - The warmest temperature of an object in an environment where water condensation from the surrounding air would form on that object.

Diffuse Radiation - Solar radiation, scattered by water vapor, dust and other particles as it passes through the atmosphere, so that it appears to come from the entire sky. Diffuse radiation is higher on hazy or overcast days than on clear days.

Direct Current (DC) - Electricity that flows continuously in the same direction because of constant polarity.

Direct Expansion (refrigeration) - Any system that, in operation between an environment where heat is absorbed (heat source), and an environment into which unwanted heat is directed (heat sink) at two different temperatures, is able to absorb heat from the heat source at the lower temperature and reject heat to the heat sink at the higher temperature. The cooling effect is obtained directly from a fluid called a refrigerant that absorbs heat at a low temperature and pressure, and transfers heat at a higher temperature and higher pressure.

Direct Radiation - Radiation that has traveled a straight path from the sun, as opposed to diffuse radiation.

Direct Solar Heat Gain - Solar energy collected from the sun (as heat) in a building through windows, walls, skylights, etc.

Distribution System (Electric utility) - The substations, transformers and lines that convey electricity from high-power transmission lines to ultimate consumers.

Dormer - A vertical window projecting from a roof.

Double Glazing - Windows having two sheets of glass with airspace between.

Dry Bulb Temperature - is the temperature of air measured by a thermometer freely exposed to the air but shielded from radiation and moisture.

Drywall - Gypsum interior wallboard used to produce a smooth and level interior wall surface and to resist fire. Also called sheetrock.

Duct - A passageway made of sheet metal or other suitable material used for conveying air or other gas at relatively low pressures.

Duct Blower - A device used for testing duct leakiness and air flow by pressuring the duct system.

Efficacy, Lighting - The ratio of light from a lamp to the electrical power consumed, including ballast losses, expressed as lumens per watt.

Efficiency - The ratio of the useful energy delivered by a dynamic system (such as a machine, engine, or motor) to the energy supplied to it over the same period or cycle of operation. The ratio is usually determined under specific test conditions.

Energy Efficiency - Using less energy/electricity to perform the same function. Programs designed to use electricity more efficiently - doing the same with less. For the purpose of this paper, energy efficiency is distinguished from DSM programs in that the latter are utility-sponsored and -financed, while the former is a broader term not limited to any particular sponsor or funding source. "Energy conservation" is a term which has also been used but it has the connotation of doing without in order to save energy rather than using less energy to do the same thing and so is not used as much today. Many people use these terms interchangeably.

EER (Energy Efficiency Ratio) - the ratio of cooling capacity of an air conditioning unit in Btus per hour to the total electrical input in watts under specified test conditions.

Electric Resistance Heater - A device that produces heat through electric resistance. For example, an electric current is run through a wire coil with a relatively high electric resistance, thereby converting the electric energy into heat which can be transferred to the space by fans.

Electric Radiant Heating - A heating system in which electric resistance is used to produce heat which radiates to nearby surfaces. There is no fan component to a radiant heating system.

Electricity - A form of energy, caused by the behavior of electrons and protons, properly called "electrical energy".

Elevation - 1) The height above sea level (altitude); 2) A geometrical projection, such as a building, on a plane perpendicular to the horizon.

Emissivity - The measure of an amount of radiation produced by a material that transfers energy from itself to the surrounding environment; expressed in a percentage. It consists a combination of three factors related to the material's surface texture, and transmissive characteristics. These factors are expressed in terms of its reflectivity, its transmissivity, and its absorptivity. Each factor, expressed as a percentage, when added together equals a sum that is less than 1.0.

Emittance - The emissivity of a material, expressed as a fraction. Emittance values range from 0.05 for brightly polished metals to 0.96 for flat black paint.

Energy - The capacity for doing work. Forms of energy include: thermal, mechanical, electrical and chemical. Energy may be transformed from one form into another.

Energy Recovery Ventilator - A ventilator that recovers latent and sensible energy from the exhaust air stream and transfers it to the incoming air stream.

Enthalpy - The quantity of heat necessary to raise the temperature of a substance from one point to a higher temperature. The quantity of heat includes both latent and sensible.

Envelope - The building shell. The exterior walls, floor, and roof assembly of a building.

Equivalent Full Load Compressor Hours (EFLCH) add up the total minutes a typical air conditioner would operate per year and divide by 60 minutes per hour.

Evaporation - The change that occurs when a liquid becomes a gas. Evaporation is the key process in the operation of air conditioners and evaporative coolers.

Evaporative Cooling - Cooling by exchange of latent heat from water sprays, jets of water, or wetted material.

Evaporator - The heat transfer coil of an air conditioner or heat pump that cools the surrounding air as the refrigerant inside the coil evaporates and absorbs heat.

Exfiltration - Air flow outward through a wall, building envelope, etc.

Expansion Valve - A valve that meters refrigerant into the evaporator.

Exhaust - Air removed deliberately from a space, by a fan or other means, usually to remove contaminants from a location near their source.

Fahrenheit - A temperature scale in which the boiling point of water is 212 degrees and its freezing point is 32 degrees.

Fan Coil - A component of a heating, ventilation and air conditioning (HVAC) system containing a fan and heating or cooling coil, used to distribute heated or cooled air.

Fenestration - In simplest terms, windows or glass doors. Technically fenestration is described as any transparent or translucent material plus any sash, frame, mullion or divider. This includes windows, sliding glass doors, French doors, skylights, curtain walls and garden windows.

Fiberglass - A fibrous material made by spinning molten glass.

Fire Stop - Framing member designed to stop the spread of fire within a wall cavity.

Flat Plate - A device used to collect solar energy. It is a piece of metal painted black on the side facing the sun, to absorb the sun's heat.

Flammable - The rating for building materials that will burn readily when exposed to a flame.

Flashing - Waterproof material used to prevent leakage at intersections between the roof surface at walls or penetrations.

Floor Joists - The framing members that support the floor.

Flue - A channel within an appliance or chimney for combustion gases.

Flue Gas - Gas that is left over after fuel is burned and which is disposed of through a pipe or stack to the outer air.

Fluorescent Lamp - A tubular electric lamp that is coated on its inner surface with a phosphor and that contains mercury vapor whose bombardment by electrons from the cathode provides ultraviolet light which causes the phosphor to emit visible light either of a selected color or closely approximating daylight.

Foamboard - Plastic foam insulation manufactured most commonly in 4'x8' sheets in thicknesses of 1/4" to 3".

Footcandle - A unit of illuminance on a surface that is one foot from a uniform point source of light of one candle and is equal to one lumen per square foot.

Footing - The part of a foundation system that actually transfers the weight of the building to the ground.

Forced Air Unit (FAU) - A central furnace equipped with a fan or blower that provides the primary means for circulation of air.

Framing Effects - The effect of framing (wood or metal studs, joists, beams, etc.) on the overall U-value of a wall, roof, floor, window or other building surface. Framing generally increases the U-Value and decreases the R-Value of insulated surfaces.

Framing Percentage - The area of actual framing in an envelope assembly divided by the overall area of the envelope assembly. This percentage is used to calculate the overall U-value of an assembly.

Frequency - The number of cycles which an alternating current moves through in each second. Standard electric utility frequency in the United States is 60 cycles per second, or 60 Hertz.

Frost Line - The maximum depth of the soil where water will freeze during the coldest weather.

Furring - Wood strips providing a space for insulation.

Gable - The triangular section of an end wall formed by the pitch of the roof.

Gallon - A unit of volume. A U.S. gallon has 231 cubic inches or 3.785 liters.

Gas - Gaseous fuel (usually natural gas) that is burned to produce heat energy. The word also is used, colloquially, to refer to gasoline.

Gasket - Elastic strip that seals a joint between two materials.

General Lighting - Lighting designed to provide a substantially uniform level of illumination throughout an area, exclusive of any provision for special visual tasks or decorative effects.

Geothermal Gradient - The change in the earth's temperature with depth. As one goes deeper, the earth becomes hotter.

Grid - A system of interconnected power lines and generators that is managed so that the generators are dispatched as needed to meet the requirements of the customers connected to the grid at various points. Gridco is sometimes used to identify an independent company responsible for the operation of the grid.

Glass Load Factor - A number combining glass' solar heat transmission and its heat conduction. Used for cooling load calculations.

Glazing - Glass installation-pertaining to glass assemblies or windows.

Gross Area - The area of a surface including areas not belonging to that surface (such as windows and doors in a wall).

Head - Foot pounds of mechanical energy per pound of fluid created by a pump.

Heat Capacity - The amount of heat necessary to raise the temperature of a given mass one degree. Heat capacity may be calculated by multiplying the mass by the specific heat.

Heat Gain - an increase in the amount of heat contained in a space, resulting from direct solar radiation, heat flow through walls, windows, and other building surfaces, and the heat given off by people, lights, equipment, and other sources.

Heat Loss - A decrease in the amount of heat contained in a space, resulting from heat flow through walls, windows, roof and other building surfaces and from ex-filtration of warm air.

Heat Pump - An air-conditioning unit which is capable of heating by refrigeration, transferring heat from one (often cooler) medium to another (often warmer) medium, and which may or may not include a capability for cooling. This reverse-cycle air conditioner usually provides cooling in summer and heating in winter.

Heat Rate - A number that tells how efficient a fuel-burning power plant is. The heat rate equals the Btu content of the fuel input divided by the kilowatt-hours of power output.

Heat-Recovery Ventilator - A central ventilator that transfers heat from exhaust to intake air, or vice versa.

Heat Transfer - Flow of heat energy induced by a temperature difference. Heat flow through a building envelope typically flows from a heated, or hot area to a cooled, or cold area.

Heat-Transfer Coefficient - See U-value.

Heating Degree Day - A unit that measures the space heating needs during a given period of time.

Heating Load - The rate at which heat must be added to a space in order to maintain the desired temperature within the space.

Heating Season Performance Factor - A representation of the total heating output of a central air-conditioning heat pump in Btus during its normal usage period for heating, divided by the total electrical energy input in watt-hours during the same period.

Home Heating Index - The number of Btus of energy used by a home divided by its area in square feet, then divided by the number of heating degree days during the time period.

House Pressure - The difference in pressure between the indoors and outdoors measured by a manometer.

Horsepower (HP) - A unit for measuring the rate of doing work. One horsepower equals about three-fourths of a kilowatt (745.7 watts).

Humidistat - An automatic control that switches a fan, humidifier, or dehumidifier on and off to control relative humidity.

HVAC (Heating Ventilation and Air Conditioning) - A system that provides heating, ventilation and/or cooling within or associated with a building.

Hydronic Heating - A system that heats a space using hot water which may be circulated through a convection or fan coil system or through a radiant baseboard or floor system.

Illumination - The light level measured on a horizontal plane in footcandles.

Incandescent Lamp - The common light bulb found in residential lamps and light fixtures and sold in stores everywhere. They produce light by passing an electric current through a filament (resistor), which also produces significant heat.

Inch of Water Column - Small air pressure differences are measured in inches of water column in the American measurement system. The linear measurement (inches of water) is determined by the height of water column that can be supported by the pressure force.

Infiltration - The inflow of outdoor air into the indoors, which is accompanied by an equal outflow of air from indoors to the outdoors.

Infrared - Pertaining to the wavelengths of light that is longer than the visible spectrum of light emitted by the sun or warm objects on Earth. Although sometimes referred to as heating rays, in fact all wavelengths of light produce heat. The infrared spectrum encompasses wavelengths from 750 nanometers or microns to 1 millimeter.

Insolation - The amount of solar radiation striking a surface.

Insulated Glass - Two or more glass panes spaced apart and sealed in a factory.

Insulation - Material with relatively high thermal resistance.

Intermediate Zone - A zone located between the building's conditioned spaces and outdoors, like a crawl space or attic.

Intermittent-Ignition Device - A device that lights the pilot light on a gas appliance when the control system calls for heat, thus saving the energy wasted by a standing pilot.

Internal Gains - The heat generated by bathing, cooking, and operating appliances, that must be removed during the summer to promote comfort.

Jamb - The side or top piece of a window or door frame.

Joist - A horizontal wood framing member that supports a floor or ceiling.

Kilowatt - A unit of electric power equal to 1000 joules per second or 3412 Btus per hour.

Kilowatt-Hour - A unit of electric energy equal to 3600 kilojoules or 3412 Btus.

Kinetic Energy - Energy in transition or motion.

Lamp - A generic term for a man-made light source often called a bulb or a tube. Sometimes refers to the portable luminaires on tables and floors of homes.

Latent Heat - The heat absorbed or released by a substance when it changes state-for instance, from a liquid to a gas.

Lath - Perforated base for plaster or stucco, formerly wood, now metal.

Low-E - Short for low emissivity, which means the characteristic of a metallic glass coating to resist the flow of radiant heat.

Low-Water Cutoff - A float-operated control for turning the burner off if a steam boiler is low on water.

Lumen - A unit of light output from a lamp.

Luminaire - A light fixture.

Main Panel Box - The service box containing a main switch, and the fuses or circuit breakers located inside the home.

Make-Up Air - Air drawn into a space to replace exhausted air.

Manometer - Measuring device for fluid pressures.

Mastic - A thick creamy substance used to seal seams and cracks in building materials.

Metering Device - In refrigeration, an orifice or capillary tube that meters refrigerant into an evaporator.

Natural Ventilation - Ventilation using natural air movement, without fans.

Net Free Area - The area of a vent after that area has been adjusted for insect screen, louvers, and weather coverings. The net free area is always less than the actual area.

Open-Combustion Heater - A heater that takes its combustion air from the surrounding room.

Output - The useful energy that a device produces after accounting for waste involved in the energy transfer.

Oxygen Depletion Sensor - A safety device for unvented combustion heaters that shuts gas off when oxygen is depleted.

Packaged Air Conditioner - An air conditioner that contains the compressor, evaporator, and condenser in a single cabinet.

Pascal - A unit of measurement of air pressure. (See Inch of water.)

Payback Period - The number of years that an investment in energy conservation will take to repay its cost in energy savings.

Perlite - A heat-expanded mineral used for insulation.

Permeability - A measurement of how much water vapor a material will let pass through it per unit of time.

Photoresistor - Electronic sensing device used to sense flame, daylight, artificial light.

Plate - A piece of lumber installed horizontally to which the vertical studs in a wall frame are attached.

Plenum - The piece of ductwork that connects the air handler to the main supply duct.

Polyethylene - Polymer plastic used for vapor barriers, air barriers, and foam backer rod.

Polyisocyanurate - Plastic foam insulation sold in sheets, similar in composition to polyurethane.

Polystyrene - Rigid plastic foam insulation, usually white or blue in color.

Polyurethane - Versatile plastic foam insulation, usually yellow in color.

Potential Energy - Energy in a stored or packaged form.

Pressure - A force encouraging flow by virtue of a difference in some condition between two areas.

Pressure Boundary - An air barrier--usually the primary air barrier.

Pressure Pan - A device used to block a duct register, while measuring the static pressure behind it, during a blower door test.

Psychometrics - The science of the relationship between air, water vapor, and heat.

Purlins - Framing members that sit on top of rafters, perpendicular to them, designed to spread support to roofing materials.

R-Value - A measurement of thermal resistance.

Radiant Barrier - A foil sheet or coating designed to reflect heat rays or retard their emission.

Radiant Temperature - The average temperature of objects in a home such as walls, ceiling, floor, furniture, and other objects.

Radiant - Heat energy, which originates on a hot body like the sun, and travels from place to place through the air.

Radon - A radioactive gas that decomposes into radioactive particles.

Rafter - A roof beam that follows the roof's slope.

Recovery Efficiency - A water heater's efficiency at actually heating incoming water.

Reflectance - The ability of a material's surface to reflect radiant heat-also called reflectivity.

Refrigerant - A special fluid used in air conditioners and heat pumps that heats air when it condenses and cools air when it evaporates.

Register - A grille covering a duct outlet.

Relative Humidity - The percent of moisture absorbed in the air compared to the maximum amount possible. Air that is saturated has 100% relative humidity.

Reset Controller - A device that adjusts fluid temperature or pressure in a central heating system according to outdoor air temperature.

Resistance - The property of a material resisting the flow of electrical energy or heat energy.

Retrofit - An energy conservation measure that is applied to an existing building. Also means the action of improving the thermal performance or maintenance of a building.

Return Air - Air circulating back to the furnace from the house, to be heated by the furnace and supplied to the rooms.

Rim Joist - The outermost joist around the perimeter of the floor framing.

Room Air Conditioner - A unitary air conditioner installed through a wall or window, which cools the room by removing heat from the room and releasing it outdoors.

Room Heater - A heater located within a room and used to heat that room.

Sash - A movable or stationary part of a window that frames a piece of glass.

Saturation - The point at which a material has absorbed its maximum amount of a liquid.

Savings-to-Investment Ratio - Measures how many times an energy retrofit pays for itself during its lifetime.

Scale - Dissolved minerals that precipitate inside boilers and storage tanks.

Sealed Combustion Heater - A heater that draws combustion air from outdoors and has a sealed exhaust system.

Seasonal Energy Efficiency Rating - A measurement of energy efficiency for central air conditioners. The SEER is computed by dividing cooling capacity, measured in Btuh, by the watts.

Sensible Heat - The heat absorbed by a substance which raises its temperature.

Sequencer - A bimetal switch that turns on the elements of an electric furnace in sequence.

Service Equipment - The electric meter and main switch, usually located outside the building.

Shading Coefficient - A decimal describing how much solar energy is transmitted through a window opening, compared to clear single glass, which has an SC of 1.0.

Sheathing - Structural sheeting, attached on top of the framing, underneath siding and roofing of a building.

Sheeting - Any building material used for covering a building surface.

Sheetrock - See drywall

Shell - The building's exterior envelope—consisting of walls, floor, and roof of a building.

Short Circuit - A dangerous malfunction in an electrical circuit, where electricity is flowing through conductors without going through an electric resistor, like a light or motor.

Sill - The bottom of a window or door frame.

SIR - See savings-to-investment ratio.

Sling Psychrometer - A device holding two thermometers that is slung through the air to measure relative humidity.

Soffit - The underside of a roof overhang or a small lowered ceiling, as above cabinets or a bathtub.

Solar Gain - Heat from the sun that is absorbed by a building and contributes to the need for cooling.

Solar Heat - Radiant energy from the sun with wavelengths between 0.7 and 1 micrometers.

Solar Heat Gain Coefficient - The ratio of solar heat gain through a window to incident solar heat. Includes both transmitted heat and absorbed and reradiated heat.

Solar Transmittance - The percent of total solar energy transmitted by a material.

Space Conditioning - Heating, cooling, or ventilation of an indoor space.

Space Heating - Heating the living spaces of the home.

Specific Heat - The ratio of a material's heat storage capacity to the heat storage capacity of water.

Split-System Air Conditioner - An air conditioner that has the condenser and compressor outdoors and the evaporator indoors.

Stack Effect - The draft established in a building from air infiltrating low and exfiltrating high.

Standing Losses - Losses from a hot water storage tank through its shell.

State Point - Air at a particular temperature and humidity occupies a single point on the psychrometric chart called a state point.

Steady-State Efficiency - The efficiency of a heating appliance, after an initial start-up period, that measures how much heat crosses the heat exchanger. The steady-state efficiency is measured by a combustion analyzer.

Steam Trap - An automatic valve that closes to trap steam in a radiator until it condenses.

Steam Vent - A bimetal-actuated air vent that allows air to leave steam piping and radiators, but closes when exposed to steam itself.

Stop - A thin trim board for windows and doors to close against or slide against.

Strike Plate - The metal plate attached to the door jamb that the latch inserts into upon closing.

Stucco - Plaster applied to the building's exterior walls.

Stud - A vertical framing member used to build a wall.

Subcooling - The number of degrees Fahrenheit that a condenser and nearby piping cools the liquid refrigerant below its saturation temperature.

Subfloor - The sheathing over the floor joists and under the flooring.

Substrate - A layer of material to which another layer is applied.

Superheat - The number of degrees Fahrenheit that an evaporator and nearby piping heats gaseous refrigerant above its saturation temperature.

Supply Air - Air that has been heated or cooled and is then moved through the ducts and out the supply registers of a home.

Task Lighting - Lighting provided at the area where a visual task is performed.

Therm - A unit of energy equaling 100,000 Btus or 29.3 kilowatt-hours.

Thermal Break - A piece of relatively low conducting material between two high conducting materials.

Thermal Bridging - Rapid heat conduction resulting from direct contact between very thermally conductive materials like metal and glass.

Thermal Conductance - General term applied to K-value, meaning conduction heat-flow rate.

Thermal Resistance - Same as R-value, expressing ability to retard heat flow.

Thermal Transmittance - Expressed as U-value, thermal transmittance is heat flow by conduction, convection, and radiation through a non-uniform layered building component like a wall.

Thermistor - An electronic resistor used to sense temperature.

Thermocouple - A bimetal-junction electric generator used to keep the safety valve of an automatic gas valve open.

Thermodynamics - is the study of the conversion of heat energy into different forms of energy.

Threshold - The raised part of a floor underneath a door that acts as an air and dust seal.

Tracer Gas - A harmless gas used to measure air leakage in a building.

Transformer - A double coil of wire that increases or decreases voltage from a primary circuit to a secondary circuit.

Truss - A lightweight, rigid framework designed to be stronger than a solid beam of the same weight.

U-Factor - The amount of heat that will flow through a square foot of a building assembly consisting of multiple sections of materials.

U-Value - See U-factor

Ultraviolet Radiation - Solar radiation having wavelengths shorter than visible light.

Unconditioned Space - An area within the building envelope that is not intentionally heated or cooled.

Underlayment - Sheeting installed to provide a smooth, sound base for a finish material.

Vapor Barrier - A material that retards the passage of water vapor.

Vapor Diffusion - The flow of water vapor through a solid material.

Vapor Diffusion Retarder - See vapor barrier.

Vaporize - Change from a liquid to a gas.

Vent Connector - The vent pipe carrying combustion gases from the appliance to the chimney.

Vent Damper - An automatic damper powered by heat or electricity that closes the chimney while a heating device is off.

Ventilation - The movement of air through an area for the purpose of removing moisture, air pollution, or unwanted heat.

Venting - The removal of combustion gases by a chimney or other type of combustion vent.

Vermiculite - A heat-expanded mineral used for insulation. Sometimes contains asbestos.

Visible Transmittance (VT) - The percent of visible light transmitted by a glass assembly.

Volt - The electrical potential contained in each unit of charge in joules per coulomb.

Watt - A unit of electrical power equivalent to one joule per second or 3.4 Btuh.

Watt-Hour - A unit of electrical energy equivalent to 3600 joules or 3.4 Btus.

Weatherization - The process of reducing energy consumption and increasing comfort in buildings by improving energy efficiency of the building.

Weatherstripping - Flexible gaskets, often mounted in rigid metal strips, for limiting air leakage.

Webbing - A reinforcing fabric used with mastics and coatings to prevent patches from cracking.

Weep Holes - Holes drilled for the purpose of allowing water to drain out of an area in a building where it has collected.

Wet-Bulb Temperature - The temperature of a dampened thermometer of a sling psychrometer used to determine relative humidity, dew point, and enthalpy.

Window Films - Plastic films, coated with a metallized reflective surface that are adhered to window glass to reflect heat rays from the sun.

Window Frame - The sides, top, and sill of the window which forms a box around window sashes and other components.

Worst-Case Depressurization Test - A safety test, performed by specific procedures, designed to assess the probability of chimney backdrafting.

WRT - Acronym meaning “with reference to” used to show that the air pressures between two areas are being measured and compared.

Zone - A room or portion of a building separated from other rooms by an air barrier--not usually an effective air barrier.

Additional Terms:

Index

A

ADM	<i>see Airtight Drywall Method</i>
Air Barrier	21, 22, 25, 64 - 71
Air Conditioner	<i>see Air Conditioning</i>
Air Conditioning	123 - 129
Air Handler	123
Air Handling Unit	61, 126, 127, 150
Air Leakage	53 - 72
Air Movement	13, 15
Air Quality	13, 16, 75, 137, 144
Air Source Heat Pump	123, 129-131, 135
Airtight Drywall Method	64
Appliances	165 - 168
Apron	110
Attic	98 - 103, 173, 182 - 183
Attic Access	61
Attic Blocking	100 - 101
Attic Ventilation	98 - 99, 182
Awning	118 - 119

B

Baffle	22, 99 - 100, 105
Band Joist	66, 81, 84
Batch Solar Water Heating	164
Batt insulation	74, 89, 102
Blower	54, 56, 123, 140
Blower Door	56 - 58
Blown Loose-fill Insulation	89
Boots	151
Bottom Plate	60, 81
Branch Duct	123
Btu	31, 187
Building Envelope	32, 53, 73
Bulk Moisture Transport	23, 27
Bypass damper	126
Bypasses	56, 58 - 59, 62 - 63

C

Cantilevered Floor	84
Capillary Action	24 - 25, 27
Capillary Break	22, 24
Carbon Monoxide	13, 29, 136
Carbon Monoxide Detector	29
Casement	113 - 114
Catalytic Device	136
Cathedral Ceiling	105 - 107
Caulking	23, 59
Caulking, Firestop	59
Caulking, Heat-Resistant	
Ceiling	67, 98 - 99, 105 - 107
Ceiling Joist	102 - 103
Cellulose Insulation	74 - 75

Central Exhaust Fan	141
Chases	61
Chimney	101
Code	41
Collector	163 - 164
Compressor	126 – 128, 130
Condensation	17 – 20, 117
Condensing Coil	126 – 127, 130
Condensing Unit	126 - 127
Conduction	14, 28, 110 – 111
Convection	15, 110 - 111
Convection current	111, 116
Cooling coil	134
Cooling Equipment	48
Corner Framing	87
Corner Studs	88
Crawlspace	25, 66
D	
Damper	125 - 126
Dehumidification	123 – 124
Dehumidification Ventilation Systems	140
Direct Vent Heater	137
Dishwasher	165 – 167
Doorbell Transformer	101
Doors	109, 121
Double-glazed Window	109, 111 – 113, 122
Double-hung Windows	113 - 114
Drainage Plane	23 - 26
Dropped Soffit	61 – 62, 67
Dryer, Clothes	167 - 168
Duct Design	151 - 157
Duct Leakage	29, 144 - 151
Duct Leaks	<i>see Duct Leakage</i>
Duct Materials	143
Duct Sealing	144 - 150
Duct Test	149
Duct Testing Fan	148 - 149
Ductboard	143
Ducts	143 - 157
Ductwork	129, 143 – 144, 146 – 148, 151 - 153
E	
Eave	102 – 103
Efficient Windows	<i>see Windows, Efficient</i>
Electrical Box	60, 69 - 70
Electric Water Heaters	<i>see Water Heaters, Electric</i>
Electronic Windows	<i>see Windows, Electronic</i>
EnergyGuide Label	166 - 167
Envelope	<i>see Building Envelope</i>
Evergreens	9 - 11
Exhaust Fan	60, 141, 168
Exposed Rafter	106 - 107
Exterior Finish	81, 96

F

Fan Control Switch	149
Filter	123
Fixed Window	113 - 114
Flashing	22 - 23, 70
Flex-duct	143, 146 - 147
Floor Insulation	81 - 82, 84
Floor Insulation, Framed	81 - 82
Floor Joists	82
Flue	58 - 59, 61, 132 - 133, 136
Foam Blocks	80
Foam Insulation	<i>see Insulation, Foam</i>
Foam Panel	80 - 81, 91
Foam Sheathing	70 - 71, 84 - 86, 95
Footing	2, 22
Forced-air System	123
Foundation	2 - 3
Foundation Drain	8, 22, 23
Foundation Insulation	77 - 78
Foundation Vent	77 - 78
Foundation Wall	23, 73 - 74, 76 - 77, 81
Framed Wall	66, 79, 86
Full Width Batts	102
Furnaces	131 - 133
Furring Strips	24, 78- 79

G

Gas Water Heaters	<i>see Water Heaters, Gas</i>
Geothermal Heat Pumps	<i>see Heat Pumps, Geothermal</i>
Ground Cover	10 - 11, 81, 83

H

Heat Exchanger	131, 133, 140 - 141, 161, 163
Heat Pump	129 - 131
Heat Pump, Geothermal	130 - 131
Heat Pump Water Heaters	<i>see Water Heaters, Heat Pump</i>
Heat Recovery Unit	161
Heat Recovery Ventilator	140 - 141
Heat-Resistant Caulking	<i>see Caulking, Heat-Resistant</i>
Heat Transfer	14
Heating	129 - 137
Heating Coil	134
Heating Source	123
Heating Systems	129 - 137
Holes	34, 54
Home Blower Door Test	<i>see Blower Door</i>
Hopper Windows	113
Hot Water	<i>See Water Heating</i>
Hot Water Use	160
Housewrap Air Barriers	<i>see Air Barrier</i>
Humidity	13 - 14, 18 - 23, 78
HVAC	123 - 142
HVAC, Sizing	124

I
 ICF *see Insulated Concrete Form*
 Inadequate Air Flow 128
 Indoor Air Quality 16, 75, 137 - 138
 Infiltration 29, 54 – 57, 113, 137
 Infiltration Rates 57
 Inlet Vent 139 - 140
 Inset Framing 93
 Inside Coil 130
 Instantaneous Water Heaters *see Water Heaters, Instantaneous*
 Insulated Floor 82
 Insulated Sheathing 81
 Insulating Jacket 161
 Insulation 74 - 108
 Insulation baffles 99
 Insulation, Fiberglass Batt 74, 188
 Insulation, Foam 76, 90 – 91
 Insulation, Loose-Fill 74 – 76, 89, 188
 Insulation Materials 73 - 75
 Insulation Strategies 76
 Integrated Space and Water Heating 133 - 135
 Interior Foam Wall Insulation 78 - 79
 Interior Shading 119 - 120
 International Residential Code 32 – 33, 37, 41

J
 Jamb 66
 Jump Duct 154

K
 Kitchen Exhaust 139, 168
 Knee Wall 73

L
 Landscaping 10 - 11
 Let-In Bracing 86
 Lighting 168 - 171
 Loose-Fill Insulation *see Insulation, Loose-Fill*
 Low-Emissivity Coatings 115
 Low-E, Gas-Filled Windows 109, 116
 Low-E Windows 109, 111, 114 – 116, 122
 Lower Sash 110

M
 Manual D 129, 152
 Manual J 124, 128 - 129
 Masonry Chimney 101
 Mechanical System Driven Infiltration 56
 Mechanical Ventilation 48, 51, 137
 Meeting Rail 110
 Metal Chimney 101
 Metal Door 121
 Metal Duct 143, 147
 Metal Window 114 - 115

Moisture 14, 17 – 29, 70
 Moisture Control 23
 Mold 13, 16, 20 – 22, 53, 144
 Molded-Expanded Polystyrene 74
 Mortgage 37 - 40
 Mortgage Rate 39 - 40

N

National Fenestration Rating Council *see NFRC*
 Natural Cooling 4 - 5
 Natural Ventilation 6
 NFRC 112, 116 - 117
 NFRC Label 112, 117

O

Odors 6, 13
 Outdoor Coil 130
 Overhang 3, 7 – 9, 119, 122

P

Parting Stop 110
 Partition Wall 64, 67, 87 - 88
 Passive Solar 4, 28, 109
 Penetrations 22, 25, 58 – 60, 66 - 68
 Pier Foundation 82
 Plumbing 61
 Plywood Sheathing 95
 Polyethylene 58
 Polyisocyanurate 74, 76, 95 – 96, 188
 Polystyrene 74 – 76, 96
 Polystyrene beads 77
 Powered Attic Ventilators 99
 Pressure Boundary 53 - 54
 Pressure Gauge 149
 Pressure Imbalance 29, 144
 Pressure Problems 99
 Pressure-Treated Sill plate 81
 Programmable Thermostats 52, 125

R

R-value 74 - 79, 112, 188
 Radiant Heat Barrier 28, 107 - 108
 Radiant Heat Flow 11, 113, 115
 Radiant Surfaces 136
 Radiation 15, 112, 115, 176, 187
 Radon 13, 16, 22, 53
 Rafters 103, 105 - 107
 Rail 110
 Raised Heel Trusses 103
 Raised Top Plate 103
 Recessed Lamp 27, 105
 Recessed Lights 60, 63, 67, 101
 Reflective Films 120
 Reflective Roof Material 175
 Refrigerant 126 – 130, 161

Refrigerant Lines	123, 128
Registers	61, 144, 152
Relative Humidity	13, 18 – 21, 78
Return Air	126, 145, 153
Return Duct	134, 141
Return Grille	148 - 149
Return Plenum	123
Ridge	98
Ridge Vent	98, 183
Roll-Down Shades	119
Roof Deck	107, 173 - 174

S

Sealant	59, 81
Sealing Bypasses	62
Seasonal Energy Efficiency Ratio	<i>see SEER Rating</i>
SEER Rating	127 – 128, 189
Sensible Cooling	124
Sensible Heating Fraction	124
Shading Coefficient	113
Shading Design Strategies	11
Sheathing Costs	96
Shelf-Mounted Systems	150
SHGC	<i>see Solar Heat Gain Coefficient</i>
Shrubs	10 - 11
Shutters	119 – 121
Sill	110, 117
Sill Plate	60, 81
Single-glazed Windows	109, 114
Single-hung Windows	113
SIP	92 – 93, 174
Site Planning	1 - 12
Slab-on-Grade	2
Slab-on-Grade Insulation	77
Snap Tie Systems	80
Soffit Vent	102, 104, 182 - 183
Solar Heat Gain Coefficient	112, 114, 117, 122
Solar Storage Tank	163
Solid Windows	<i>see Windows, Solid</i>
Spot Fans	138
Spray-on Systems	81
Stack Effect	7, 54 – 55
Standard Framing	85, 88
Stool	110
Structural Insulated Panels	<i>see SIP</i>
Structural System	21 - 22
Subfloor	60, 66, 81
Supply Duct	134
Supply Leaks	145
Supply Plenum	123

T

Takeoffs	147, 151
Temperature	13, 18 - 20
Temperature Controls	125, 190
Termites	13, 77, 81

Termite Inspection Strip	83
Thermal Break	113 - 115
Throttling Valve	126
Tint	112, 114, 120, 122
Top plate	69 – 70, 85
Trees	10 – 11, 118
Trunk Duct	123
Truss, Floor	81, 84
Truss Roof	103, 173
U	
U-value	112, 114, 116 - 117
Unvented Fuel-Fired Heaters	136 - 137
V	
Vapor Barrier	25 – 27, 65, 67, 71
Vapor Diffusion	25 - 27
Vapor Transport	26
Venetian Blinds	119
Vent Pipes	101, 153
Ventilation	6, 42, 98 – 99, 137 - 141
Ventilation Channel	105
Ventilation Ducts	132
Ventilation Plans	141
Vermiculite	77, 188
Visible Light Transmittance	113, 114, 117
Visible Transmittance	<i>see Visible Light Transmittance</i>
W	
Wall Construction	85 - 97
Wall Framing	85, 87
Wall Sheathings	95 - 96
Washing Machines	167
Water Heaters	130, 134 – 135, 159 - 165
Water Heaters, Electric	161
Water Heaters, Gas	160
Water Heaters, Heat Pump	162
Water Heaters, Instantaneous	165
Water Heaters, Solar	162 - 164
Water Heating	159 - 165
Water Vapor	<i>see Moisture</i>
Water Vapor Transport	<i>see Vapor Transport</i>
Waterproofing	184
Weatherstripping	58, 61, 63, 121
Whole House Fan	61
Wind	5 – 6, 12, 54 - 55
Wind Driven Infiltration	55
Wind Rose	5 - 6
Window Alternatives	114
Window Anatomy	110
Window Installation	117
Window Insulating Values	116 - 117
Window Performance	112 – 114, 117
Window Shading	118 - 121
Window Spacers	114
Window Temperatures	118

Window Types	113
Windows	109 - 121
Windows, Efficient	28, 111
Windows, Electronic	121
Windows, Solid	121
Winter Heat Loss	111
Wiring Hole	60, 93
Wood Heating	135 - 137
Wood-Framed Roof	104

Z

Zoned System	126
--------------	-----