

Louisiana Coastal Protection and Restoration Authority



Franklin Canal Flood Protection System Phase II – Pump Station (Community Development Block Grant (CDBG) Project)

Project No. TV-52

St. Mary Parish, Louisiana

Contract Documents & Specifications Pump Station

August 2013

SEI Project No. 148184

Prepared by:

Shaw Environmental & Infrastructure, Inc.
(A CB&I Company)

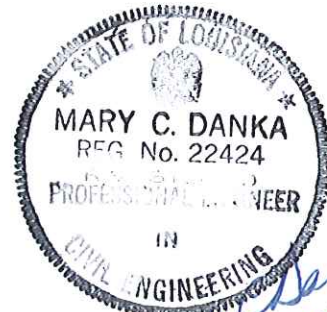

Mary C. Danka
21 March 2014

**MAIN TABLE OF CONTENTS
FRANKLIN CANAL FLOOD PROTECTION SYSTEM
PHASE II – PUMP STATION**

ADVERTISEMENT FOR BIDS

INSTRUCTION TO BIDDERS

BID FORM

BID BOND

CONTRACT BETWEEN OWNER AND CONTRACTOR

ATTESTATIONS AFFIDAVIT

Section	Title	Page No.
PART I GENERAL PROVISIONS		
GP-1	DEFINITION OF TERMS	1
GP-2	BID REQUIREMENTS	4
GP-3	AVAILABILITY OF PLANS AND SPECIFICATIONS	5
GP-4	LAWS, REGULATIONS, STANDARDS, SPECIFICATIONS, AND CODES	5
GP-5	PRE-BID CONFERENCE AND SITE VISIT.....	6
GP-6	NOTICE OF AWARD.....	6
GP-7	NOTICE TO PROCEED AND CONTRACT TIME	7
GP-8	WORK PLAN.....	7
GP-9	PROGRESS SCHEDULE	8
GP-10	DAILY PROGRESS REPORTS	8
GP-11	HURRICANE AND SEVERE STORM PLAN	9
GP-12	HEALTH AND SAFETY PLAN AND INSPECTIONS	10
GP-13	PROGRESS MEETINGS AND REPORTS	10
GP-14	PRE-CONSTRUCTION CONFERENCE.....	11
GP-15	CONTRACT INTENT	11
GP-16	ENGINEER AND AUTHORITY OF ENGINEER.....	11
GP-17	CONFORMITY WITH PLANS AND SPECIFICATIONS.....	11
GP-18	CLARIFICATIONS AND AMENDMENTS TO CONTRACT DOCUMENTS	12
GP-19	SUBCONTRACTS.....	12
GP-20	WORKERS, METHODS, AND EQUIPMENT	12
GP-21	ACCIDENT PREVENTION, INVESTIGATIONS, AND REPORTING	13
GP-22	PRESERVATION AND RESTORATION OF PROPERTY, MONUMENTS, ETC.	14
GP-23	PROTECTION OF THE WORK, MATERIALS, AND EQUIPMENT	14
GP-24	LAND RIGHTS	14
GP-25	UTILITIES.....	14
GP-26	PERMITS.....	15
GP-27	PROJECT SITE CLEAN-UP	15
GP-28	OWNER INSPECTION	15
GP-29	DUTIES OF RESIDENT PROJECT REPRESENTATIVE.....	16
GP-30	CONSTRUCTION STAKES, LINES, AND GRADES.....	16
GP-31	CONTRACTOR’S RESPONSIBILITY FOR WORK	16
GP-32	ENVIRONMENTAL PROTECTION	16
GP-33	SANITARY PROVISION	17
GP-34	PAYMENT OF TAXES	17
GP-35	RADIO AND TELEPHONES	17

GP-36	NAVIGATION	18
GP-37	OBSTRUCTION TO NAVIGATION.....	18
GP-38	MARINE VESSELS AND MARINE ACTIVITIES.....	18
GP-39	RECORD KEEPING	19
GP-40	CERTIFICATES OF COMPLIANCE.....	19
GP-41	SUBMITTALS	19
GP-42	CLAIMS FOR EXTRA COST	19
GP-43	ALTERATION OF THE CONTRACT AND COMPENSATION	20
GP-44	EXTENSION OF CONTRACT TIME.....	20
GP-45	OWNER’S RIGHT TO TERMINATE CONTRACT FOR CAUSE OR CONVENIENCE.....	21
GP-46	TEMPORARY SUSPENSION OF WORK	22
GP-47	NON-CONFORMING AND UNAUTHORIZED WORK	22
GP-48	CONTRACTOR’S RIGHT TO TERMINATE CONTRACT.....	22
GP-49	BREACH OF CONTRACT.....	22
GP-50	NO WAIVER OF LEGAL RIGHTS	23
GP-51	LIABILITY FOR DAMAGES AND INJURIES	23
GP-52	LIABILITY FOR LOSSES BY ACTS OF THE GOVERNMENT	24
GP-53	SUBSTANTIAL COMPLETION	24
GP-54	FINAL INSPECTION AND ACCEPTANCE.....	25
GP-55	AS-BUILT DRAWINGS.....	25
GP-56	COMPLETION OF CONTRACT	26
GP-57	CONTRACTOR’S GUARANTEE	26
GP-58	DISPUTE RESOLUTION	27
GP-59	PAYMENT	27
GP-60	PAYMENTS WITHHELD.....	28
GP-61	LIENS	28
GP-62	EQUAL EMPLOYMENT OPPORTUNITY	29
GP-63	ANTI-KICKBACK CLAUSE	29
GP-64	SUSPENSION/DEBARMENT	29

PART II SPECIAL PROVISIONS

SP-1	LOCATION OF WORK.....	1
SP-2	WORK TO BE DONE.....	1
SP-3	BID ITEMS, CONTRACT DATES, AND DELIVERABLES	2
SP-4	DELIVERABLES.....	3
SP-5	ADDRESSES FOR DOCUMENT DELIVERY	5
SP-6	WORK PLAN SUPPLEMENTAL.....	6
SP-7	FAILURE TO COMPLETE ON TIME.....	6
SP-8	OFFICE FOR OWNER	6
SP-9	LANDOWNER AND UTILITY REQUIREMENTS.....	6
SP-10	OYSTER LEASE RESTRICTIONS	8
SP-11	THREATENED AND ENDANGERED SPECIES.....	8
SP-12	COMMUNICATIONS	8
SP-13	EXISTING CONDITIONS.....	9
SP-14	FLOATING PLANTS	9
SP-15	AS-BUILTS	9
SP-16	POINT FILES.....	9
SP-17	SHOP DRAWINGS.....	10
SP-18	OBSTRUCTION OF NAVIGATION WATERWAYS	10
SP-19	PUMP SYSTEM INSTALLATION.....	10
SP-20	OPERATIONS AND MAINTENANCE-FIELD DEMONSTRATION, TRAINING, AND MANUAL	11
SP-21	CPRA CONSTRUCTION INSURANCE PROVISIONS.....	11

TECHNICAL SPECIFICATIONS

DIVISION 01 GENERAL REQUIREMENTS		Pages Included
01010	MOBILIZATION AND DEMOBILIZATION	3
01 01 02	SURVEYING	5
01 57 20.00 12	ENVIRONMENTAL PROTECTION	9
01 57 23.00 12	STORMWATER POLLUTION PREVENTION MEASURES	11
DIVISION 03 - CONCRETE		
03 41 17	PRECAST CONCRETE PLATFORMS	18
DIVISION 05 - METALS		
05 12 00	STRUCTURAL STEEL	14
DIVISION 06 – WOOD, PLASTICS, AND COMPOSITES		
06 13 33	TIMBERWORK	6
06 73 01	FIBERGLASS REINFORCED PLASTIC (FRP) GRATING	7
DIVISION 08 – OPENINGS		
08 34 19.10 20	ROLLING SERVICE DOORS	6
08 91 00	METAL WALL LOUVERS	6
DIVISION 09 - FINISHES		
09 97 02	PAINTING, HYDRAULIC STRUCTURES	10
DIVISION 10 - SPECIALTIES		
10 14 01	EXTERIOR SIGNAGE	7
DIVISION 13 – SPECIAL CONSTRUCTION		
13 34 19	METAL BUILDING SYSTEMS	13
DIVISION 23 – HVAC		
23 31 13.00 40	DUCTWORK	5
DIVISION 26 - ELECTRICAL		
26 00 00.00 20	ELECTRICAL GENERAL	10
26 05 53.00 40	CONDUCTORS AND CABLE IDENTIFICATION	3
26 24 16.00 40	PANELBOARDS	4
DIVISION 31 - EARTHWORK		
31 05 19.02 12	GEOTEXTILE SEPARATOR	5

31 37 16.13	RIPRAP	3
31 62 13.20	PRECAST/PRESTRESSED CONCRETE PILES	24
31 62 14	STEEL PIPE PILES	14

DIVISION 32 – EXTERIOR IMPROVEMENTS

32 11 23	GRADED-CRUSHED AGGREGATE BASE COURSE	6
32 92 19.00 12	FERTILIZING AND SEEDING	7

DIVISION 33 – UTILITIES

33 11 23	GASLINE	12
----------	---------	----

DIVISION 35 – WATERWAY AND MARINE CONSTRUCTION

35 31 19.20	ARTICULATED CONCRETE BLOCK REVETMENT	5
-------------	--------------------------------------	---

DIVISION 40 – PROCESS INTEGRATION

40 05 13	DISCHARGE PIPING SYSTEM	9
40 05 14	IN-LINE BACKFLOW PREVENTION	3

DIVISION 43 – PROCESS GAS AND LIQUID HANDLING

43 21 40	PUMPS – WATER, VERTICAL AXIAL FLOW	25
----------	------------------------------------	----

APPENDICES

APPENDIX A	GEOTECHNICAL REPORT
APPENDIX B	CDBG CONSTRUCTION COMPLIANCE PROVISIONS
APPENDIX C	FEDERAL WAGE DETERMINATION
APPENDIX D	OWNER OBTAINED PERMITS
APPENDIX E	CLARIFICATION, CHANGE ORDER, AND ACCEPTANCE
APPENDIX F	LAND RIGHTS MEMORANDUM

INDEX TO SHEETS

G-001	TITLE SHEET
G-002	SUMMARY OF ESTIMATED BID QUANTITIES
G-003	GENERAL NOTES
G-004	OVERALL SITE PLAN
C-001	LEVEE ROAD PLAN
C-002	PUMP STATION SITE PLAN
C-003	DETAIL SITE PLAN
C-004	GEOTECHNICAL BORING LOCATIONS (SHEET 1)
C-005	GEOTECHNICAL BORING LOGS (SHEET 2)
C-006	GEOTECHNICAL BORING LOGS (SHEET 3)
C-007	GEOTECHNICAL BORING LOGS (SHEET 4)
C-008	GEOTECHNICAL BORING LOGS (SHEET 5)
C-009	GEOTECHNICAL BORING LOGS (SHEET 6)

C-010 GEOTECHNICAL BORING LOGS (SHEET 7)
S-001 PLAN AND ELEVATIONS (SHEET 1)
S-002 PLAN AND ELEVATIONS (SHEET 2)
S-003 PILE LAYOUT
S-004 PRECAST PRESTRESSED PILES SECTIONS AND DETAILS
S-005 PUMP STATION SUBSTRUCTURE
S-006 PUMP STATION SLAN PLAN
S-007 CAP BEAN SECTIONS AND DETAILS
S-008 CONCRETE SLAB SECTIONS AND DETAILS
S-009 PUMP STATION BUILDING PLANS
S-010 DISCHARGE PIPE LAYOUT PLAN
S-011 PIPE LAYOUT ELEVATION
S-012 PIPE PENETRATION ELEVATION
S-013 DISCHARGE PIPE DETAILS (SHEET 1)
S-014 DISCHARGE PIPE DETAILS (SHEET 2)
S-015 WALKWAY AND HANDRAIL DETAIL
S-016 PUMP STATION FOUNDATION AND TRASH SCREEN SECTIONS AND DETAILS (SHEET 1)
S-017 PUMP STATION FOUNDATION AND TRASH SCREEN SECTIONS AND DERAILED (SHEET 2)
E-001 PUMP STATION BUILDING ELECTRICAL PLAN
E-002 ELECTRICAL NOTES AND BLOCK DIAGRAM

**FRANKLIN CANAL FLOOD
PROTECTION SYSTEM PHASE II
PUMP STATION**

**SCHEDULE OF BID ITEMS
GENERAL PROVISIONS
SPECIAL PROVISIONS
TECHNICAL SPECIFICATIONS
APPENDICES
INDEX TO SHEETS**

AUGUST 2013

ADVERTISEMENT FOR BIDS

ADVERTISEMENT FOR BIDS

Sealed bids will be received for the State of Louisiana by the Division of Administration, Office of Facility Planning and Control, Claiborne Office Building, 1201 North Third Street, Conference Room 1-145, Post Office Box 94095, Baton Rouge, Louisiana 70804-9095 until 2:00 P.M. Tuesday June 3, 2014.

ANY PERSON REQUIRING SPECIAL ACCOMMODATIONS SHALL NOTIFY FACILITY PLANNING AND CONTROL OF THE TYPE(S) OF ACCOMMODATION REQUIRED NOT LESS THAN SEVEN (7) DAYS BEFORE THE BID OPENING.

FOR: **FRANKLIN CANAL FLOOD PROTECTION SYSTEM – PHASE II PUMP STATION**

PROJECT NUMBER: **TV - 52**

Complete Bid Documents for this project are available in electronic form. They may be obtained without charge and without deposit from <http://dnr.louisiana.gov/index.cfm?md=pagebuilder&tmp=home&pid=432>. Printed copies can also be obtained from:

COASTAL PROTECTION AND RESTORATION AUTHORITY (CPRA)
450 Laurel Street, Suite 1501
Baton Rouge, Louisiana, 70801
Attn: Renee McKee
Email: cpra.bidding@la.gov Phone: (225) 342-0811 Fax: (225) 342-4674

All bids shall be accompanied by bid security in an amount of five percent (5.0%) of the sum of the base bid and all alternates. The form of this security shall be as stated in the Instructions to Bidders included in the Bid Documents for this project.

The successful Bidder shall be required to furnish a Performance and Payment Bond written as described in the Instructions to Bidders included in the Bid Documents for this project.

A NON-MANDATORY PRE-BID CONFERENCE WILL BE HELD
at 10:00 AM CST on Wednesday, May 21, 2014 at Franklin Court House – St. Mary Parish
Government Building 500 Main St, 5th Floor, Council Meeting Room Franklin, LA 70538-6198.

Contact Nicole Cutforth at (225) 987-7373 if directions are needed to the Non-Mandatory Pre-Bid Conference.

Bids shall be accepted from Contractors who are licensed under LA. R.S. 37:2150-2192 for the classification of Heavy Construction. In accordance with LA. R.S. 37:2163(D), anyone objecting to the classification must send a certified letter to both the Louisiana State Licensing Board for Contractors and

the CPRA at the address listed above. The letter must be received no later than ten (10) working days prior to the day on which bids are to be opened.

Bidder is required to comply with provisions and requirements of LA R.S.38:2212 (A)(1)(c). No bid may be withdrawn for a period of thirty (30) days after receipt of bids, except under the provisions of LA. R.S. 38:2214.

The Owner reserves the right to reject any and all bids for just cause. In accordance with La. R.S. 38:2212 (A) (1)(b), the provisions and requirements of this Section, those stated in the advertisement bids, and those required on the bid form shall not be considered as informalities and shall not be waived by any public entity.

When this project is financed either partially or entirely with State Bonds or federal funds, the award of this Contract is contingent upon the granting of lines of credit, the sale of bonds by the Bond Commission or the commitment of federal funds. The State shall incur no obligation to the Contractor until the Contract Between Owner and Contractor is fully executed.

Coastal Protection and Restoration Authority is a participant in the Small Entrepreneurship (SE) Program (the Hudson Initiative) and the Veteran-Owned and Service-Connected Disabled Veteran-Owned (LaVet) Small Entrepreneurships Program. Bidders are encouraged to consider participation. Information is available from Coastal Protection and Restoration Authority or on its website at <http://www.coastal.la.gov/>.

STATE OF LOUISIANA
DIVISION OF ADMINISTRATION
FACILITY PLANNING AND CONTROL
MARK A. MOSES, DIRECTOR

INSTRUCTION TO BIDDERS

INSTRUCTIONS TO BIDDERS

COMPLETION TIME:

The Bidder shall agree to fully complete the contract within **Three Hundred (300)** consecutive calendar days for the Base Bid, an additional **Thirty (30)** consecutive calendar days for Additive Alternate No. 1, an additional **Thirty (30)** consecutive calendar days for Additive Alternate No. 2, and **Zero (0)** additional calendar days for Additive Alternate No. 3, subject to such extensions as may be granted under Section GP-44 of the General Provisions and acknowledges that this construction time will start on or before the date specified in the written "Notice to Proceed" from the Owner.

LIQUIDATED DAMAGES:

The Bidder shall agree to pay as Liquidated Damages the amount of **Two Thousand Four Hundred and Fifty Dollars (\$2,450.00)** for each consecutive calendar day for which the work is not complete, beginning with the first day beyond the contract completion date stated on the "Notice to Proceed" or as amended by change order.

ARTICLE 1

DEFINITIONS

1.1 The Bid Documents include the following:

- Advertisement for Bids
- Instructions to Bidders
- Bid Form
- Bid Bond
- General Provisions
- Special Provisions
- Technical Specifications
- Construction Drawings
- Contract Between Owner and Contractor and Performance and Payment Bond Affidavit
- User Agency Documents (if applicable)
- Change Order Form
- Recommendation of Acceptance
- Other Documents (if applicable)
- Addenda issued during the bid period and acknowledged in the Bid Form

1.2 All definitions set forth in the General Provisions and the Special Provisions are applicable to the Bid Documents, unless otherwise specifically stated or written.

1.3 Addenda are written and/or graphic instruments issued by the Engineer prior to the opening of bids

which modify or interpret the Bid Documents by additions, deletions, clarifications, corrections and prior approvals.

1.4 A bid is a complete and properly signed proposal to do the work or designated portion thereof for the sums stipulated therein supported by data called for by the Bid Documents.

1.5 Base bid is the sum stated in the bid for which the Bidder offers to perform the work described as the base, to which work may be added, or deleted for sums stated in alternate bids.

1.6 An alternate bid (or alternate) is an amount stated in the bid to be added to the amount of the base bid if the corresponding change in project scope or materials or methods of construction described in the Bid Documents is accepted.

1.7 A Bidder is one who submits a bid for a prime Contract with the Owner for the work described in the Bid Documents.

1.8 A Sub-bidder is one who submits a bid to a Bidder for materials and/or labor for a portion of the work.

1.9 Where the word "Engineer" is used in any of the documents, it shall refer to the Prime Designer of the project, regardless of discipline.

ARTICLE 2

PRE-BID CONFERENCE

2.1 A MANDATORY Pre-Bid Conference shall be held at the time and location described in the Advertisement for Bids. The purpose of the Pre-Bid Conference is to familiarize Bidders with the requirements of the Project and the intent of the Bid Documents, and to receive comments and information from interested Bidders. If the Pre-Bid Conference is stated in the Advertisement for Bids to be a Mandatory Pre-Bid Conference, bids shall be accepted only from those bidders who attend the Pre-Bid Conference. Contractors who are not in attendance for the entire Pre-Bid Conference will be considered to have not attended.

2.2 Any revision of the Bid Documents made as a result of the Pre-Bid Conference shall not be valid unless included in an addendum.

ARTICLE 3

BIDDER'S REPRESENTATION

3.1 Each Bidder by making his bid represents that:

3.1.1 He has read and understands the Bid Documents and his bid is made in accordance therewith.

3.1.2 He has visited the site and has familiarized himself with the local conditions under which the work is to be performed.

3.1.3 His bid is based solely upon the materials, systems and equipment described in the Bid Documents as advertised and as modified by addenda.

3.1.4 His bid is not based on any verbal instructions contrary to the Bid Documents and addenda.

3.1.5 He is familiar with the Code of Governmental Ethics requirement that prohibits public servants and/or their immediate family members from bidding on or entering into contracts; he is aware that the Designer and its principal owners are considered Public Servants

under the Code of Governmental Ethics for the limited purposes and scope of the Design Contract with the State on this Project (see Ethics Board Advisory Opinion, No. 2009-378 and 2010-128); and neither he nor any principal of the Bidder with a controlling interest therein has an immediate family relationship with the Designer or any principal within the Designer's firm. (see La. R.S. 42:1113). Any Bidder submitting a bid in violation of this clause shall be disqualified and any contract entered into in violation of this clause shall be null and void.

3.2 The Bidder must be fully qualified under any State or local licensing law for Contractors in effect at the time and at the location of the work before submitting his bid. In the State of Louisiana, Revised Statutes 37:2150, et seq. will be considered, if applicable.

The Contractor shall be responsible for determining that all of his Sub-bidders or prospective Subcontractors are duly licensed in accordance with law.

ARTICLE 4

BID DOCUMENTS

4.1 Copies

4.1.1 Bid Documents may be obtained from the Coastal Protection and Restoration Authority as stated in the Advertisement for Bids.

4.1.1.2 In addition to the availability of printed Bid Documents, the Coastal Protection and Restoration Authority will provide the Bid Documents in electronic format. They may be obtained without charge and without deposit as stated in the Advertisement for Bids.

4.1.1.2.2 Where electronic distribution is provided, all other plan holders are responsible for their own reproduction costs.

4.1.2 Complete sets of Bid Documents shall be used in preparing bids; neither the Owner nor the Engineer assume any responsibility for errors or misinterpretations resulting from the use of incomplete sets of Bid Documents.

4.1.3 The Owner or Engineer in making copies of the Bid Documents available on the above terms, do so only for the purpose of obtaining bids on the work and do not confer a license or grant for any other use.

4.2 Interpretation or Correction of Bid Documents

4.2.1 Bidders shall promptly notify the Coastal Protection and Restoration Authority contact person listed in the Advertisement for Bids of any ambiguity, inconsistency or error which they may discover upon examination of the Bid Documents or of the site and local conditions.

4.2.2 Bidders requiring clarification or interpretation of the Bid Documents shall make a written request to the Coastal Protection and Restoration Authority contact person listed in the Advertisement for Bids, to reach him at least seven days prior to the date for receipt of bids.

4.2.3 Any interpretation, correction or change of the Bid Documents will be made by addendum. Interpretations, corrections or changes of the Bid Documents made in any other manner will not be binding and Bidders shall not rely upon such interpretations, corrections and changes.

4.3 Substitutions

4.3.1 The materials, products and equipment described in the Bid Documents establish a standard of required function, dimension, appearance and quality to be met by any proposed substitution. No substitutions shall be allowed after bids are received.

4.3.2 No substitution will be considered unless written request for approval has been submitted by the Proposer and has been received by the Engineer at least seven (7) working days prior to the opening of bids. (RS38:2295C) Each such request shall include the name of the material or equipment for which it is to be substituted and a complete description of the proposed substitute including model numbers, drawings, cuts, performance and test data and any other information necessary for an evaluation. A statement setting forth any changes in other materials, equipment or work that incorporation of

the substitute would require shall be included. It shall be the responsibility of the proposer to include in his proposal all changes required of the Bid Documents if the proposed product is used. Prior approval is given contingent upon supplier being responsible for any costs which may be necessary to modify the space or facilities needed to accommodate the materials and equipment approved.

4.3.3 If the Engineer approves any proposed substitution, such approval will be set forth in an addendum. Bidders shall not rely upon approvals made in any other manner.

4.4 Addenda

4.4.1 Addenda will be mailed or delivered to all who are known by the Coastal Protection and Restoration Authority to have received a complete set of Bid Documents.

4.4.2 Copies of addenda will be made available for inspection wherever Bid Documents are on file for that purpose.

4.4.3 Except as described herein, addenda shall not be issued within a period of seventy-two (72) hours prior to the advertised time for the opening of bids, excluding Saturdays, Sundays, and any other legal holidays. If the necessity arises of issuing an addendum modifying plans and specifications within the seventy-two (72) hour period prior to the advertised time for the opening of bids, then the opening of bids shall be extended at least seven but no more than twenty-one (21) working days, without the requirement of re-advertising. Facility Planning shall be consulted prior to issuance of such an addendum and shall approve such issuance. The revised time and date for the opening of bids shall be stated in the addendum.

4.4.4 Each Bidder shall ascertain from the Coastal Protection and Restoration Authority prior to submitting his bid that he has received all addenda issued, and he shall acknowledge their receipt on the Bid Form.

4.4.5 The Owner shall have the right to extend the bid date by up to (30) thirty days without the requirement of re-advertising. Any such extension

shall be made by addendum issued by the Coastal Protection and Restoration Authority.

ARTICLE 5

BID PROCEDURE

5.1 Form and Style of Bids

5.1.1 Bids shall be submitted on the Louisiana Uniform Public Work Bid Form provided by the Engineer.

5.1.2 All blanks on the Bid Form shall be filled in manually in ink or typewritten.

5.1.3 Bid sums shall be expressed in both words and figures, and in case of discrepancy between the two, the written words shall govern.

5.1.4 Any interlineation, alteration or erasure must be initialed by the signer of the bid or his authorized representative.

5.1.5 Bidders are cautioned to complete all alternates should such be required in the Bid Form. Failure to submit alternate prices will render the bid non responsive and shall cause its rejection.

5.1.6 Bidders are cautioned to complete all unit prices should such be required in the Bid Form. Unit prices represent a price proposal to do a specified quantity and quality of work.

5.1.7 Bidders are strongly cautioned to ensure that all blanks on the bid form are completely and accurately filled in.

5.1.8 Bidder shall make no additional stipulations on the Bid Form nor qualify his bid in any other manner.

5.1.9 The bid shall include the legal name of Bidder and shall be signed by the person or persons legally authorized to bind the Bidder to a Contract.

The authority of the signature of the person submitting the bid shall be deemed sufficient and acceptable under any of the following conditions:

(a) Signature on bid is that of any corporate officer or member of a partnership or partnership in

commendam listed on most current annual report on file with Secretary of State.

(b) Signature on bid is that of authorized representative of corporation, partnership, or other legal entity and bid is accompanied by corporate resolution, certification as to the corporate principal, or other documents indicating authority.

(c) Corporation, partnership, or other legal entity has filed in the records of the Secretary of State, an affidavit, resolution or other acknowledged or authentic document indicating the names of all parties authorized to submit bids for public contracts. A bid submitted by an agency shall have a current Power of Attorney attached certifying agent's authority to bind Bidder. The name and license number on the envelope shall be the same as the entity identified on the Bid Form.

5.1.10 On any bid in excess of fifty thousand dollars (\$50,000.00), the Contractor shall certify that he is licensed under R.S. 37: 2150-2173 and show his license number on the bid above his signature or his duly authorized representative.

5.2 Bid Security

5.2.1 No bid shall be considered or accepted unless the bid is accompanied by bid security in an amount of five percent (5.0%) of the base bid and all alternates.

The bid security shall be in the form of a certified check or cashier's check drawn on a bank insured by the Federal Deposit Insurance Corporation, or a Bid Bond written by a surety company licensed to do business in Louisiana and signed by the surety's agent or attorney-in-fact. The Bid Bond shall be written on the Coastal Protection and Restoration Authority Bid Bond Form, and the surety for the bond must meet the qualifications stated thereon. The Bid Bond shall include the legal name of the bidder be in favor of the State of Louisiana, Coastal Protection and Restoration Authority, and shall be accompanied by appropriate power of attorney. The Bid Bond must be signed by both the bidder/principal and the surety in the space provided on the Coastal Protection and Restoration Authority Bid Bond Form. Failure by the bidder/principal or the surety to sign the bid bond shall result in the rejection of the bid.

Bid security furnished by the Contractor shall guarantee that the Contractor will, if awarded the

work according to the terms of his proposal, enter into the Contract and furnish Performance and Payment Bonds as required by these Bid Documents, within ten (10) days after written notice that the instrument is ready for his signature.

Should the Bidder refuse to enter into such Contract or fail to furnish such bonds, the amount of the bid security shall be forfeited to the Owner as liquidated damages, not as penalty.

5.2.2 The Owner will have the right to retain the bid security of Bidders until either (a) the Contract has been executed and bonds have been furnished, or (b) the specified time has elapsed so that bids may be withdrawn, or (c) all bids have been rejected.

5.3 Submission of Bids

5.3.1 The Bid shall be sealed in an opaque envelope. The bid envelope shall be identified on the outside with the name of the project, and the name, address, and license number of the Bidder. The envelope shall contain **only one bid form** and will be received until the time specified and at the place specified in the Advertisement for Bids. It shall be the specific responsibility of the Bidder to deliver his sealed bid to Facility Planning and Control Department at the appointed place and prior to the announced time for the opening of bids. Late delivery of a bid for any reason, including late delivery by United States Mail, or express delivery, shall disqualify the bid.

If the bid is sent by mail, the sealed envelope shall be enclosed in a separate mailing envelope with the notation "Bid Enclosed" on the face thereof. Such bids shall be sent by Registered or Certified Mail, Return Receipt Requested, addressed to:

Facility Planning and Control,
P. O. Box 94095
Baton Rouge, Louisiana, 70804-9095.

Bids sent by express delivery shall be delivered to:
Facility Planning and Control
Suite 7-160
Claiborne Office Building
1201 North Third Street
Baton Rouge, Louisiana 70802

5.3.2 Bids shall be deposited at the designated location prior to the time on the date for receipt of bids indicated in the Advertisement for Bids, or any extension thereof made by addendum. Bids received after the time and date for receipt of bids will be returned unopened.

5.3.3 Bidder shall assume full responsibility for timely delivery at location designated for receipt of bids.

5.3.4 Oral, telephonic or telegraphic bids are invalid and shall not receive consideration. Owner shall not consider notations written on outside of bid envelope which have the effect of amending the bid. Written modifications enclosed in the bid envelope, and signed or initialed by the Contractor or his representative, shall be accepted.

5.4 Modification or Withdrawal of Bid

5.4.1 A bid may not be modified, withdrawn or canceled by the Bidder during the time stipulated in the Advertisement for Bids, for the period following the time and bid date designated for the receipt of bids, and Bidder so agrees in submitting his bid, except in accordance with R.S. 38:2214 which states, in part, "Bids containing patently obvious mechanical, clerical or mathematical errors may be withdrawn by the Contractor if clear and convincing sworn, written evidence of such errors is furnished to the public entity within forty eight hours of the Bid Opening excluding Saturdays, Sundays and legal holidays".

5.4.2 Prior to the time and date designated for receipt of bids, bids submitted early may be modified or withdrawn only by notice to the party receiving bids at the place and prior to the time designated for receipt of bids.

5.4.3 Withdrawn bids may be resubmitted up to the time designated for the receipt of bids provided that they are then fully in conformance with these Instructions to Bidders.

5.4.4 Bid Security shall be in an amount sufficient for the bid as modified or resubmitted.

ARTICLE 6

CONSIDERATION OF BIDS

6.1 Opening of Bids

6.1.1 The properly identified Bids received on time will be opened publicly and will be read aloud, and a tabulation abstract of the amounts of the base bids and alternates, if any, will be made available to Bidders.

6.2 Rejection of Bids

6.2.1 The Owner shall have the right to reject any or all bids and in particular to reject a bid not accompanied by any required bid security or data required by the Bid Documents or a bid in any way incomplete or irregular.

6.3 Acceptance of Bid

6.3.2 It is the intent of the Owner, if he accepts any alternates, to accept them in the order in which they are listed in the Bid Form. Determination of the Low Bidder shall be on the basis of the sum of the base bid and the alternates accepted. However, the Owner shall reserve the right to accept alternates in any order which does not affect determination of the Low Bidder.

ARTICLE 7

POST-BID INFORMATION

7.1 Submissions

7.1.1 The Contractor shall submit all required deliverables in conformance with Section SP-4 of the Special Provisions.

It is the preference of the Owner that, to the greatest extent possible or practical, the Contractor utilize Louisiana Subcontractors, manufacturers, suppliers and labor.

7.1.2 The Contractor will be required to establish to the satisfaction of the Engineer the reliability and responsibility of the proposed Subcontractors to furnish and perform the work described in the sections of the Specifications pertaining to such proposed Subcontractor's respective trades. The General Contractor shall be

responsible for actions or inactions of Subcontractors and/or material suppliers.

The General Contractor is totally responsible for any lost time or extra expense incurred due to a Subcontractor's/or Material Supplier's failure to perform. Failure to perform includes, but is not limited to, a Subcontractor's financial failure, abandonment of the project, failure to make prompt delivery, or failure to do work up to standard. Under no circumstances shall the Owner mitigate the General Contractor's losses or reimburse the General Contractor for losses caused by these events.

7.1.3 Subcontractors and other persons and organizations selected by the Bidder must be used on the work for which they were proposed and shall not be changed except with the written approval of the Owner and the Engineer.

In accordance with La. R.S. 38:2227, LA. R.S. 38:2212.10 and LA. R.S. 23:1726(B) each bidder on this project must submit the completed Attestations Affidavit (Past Criminal Convictions of Bidders, Verification of Employees and Certification Regarding Unpaid Workers Compensation Insurance) form found within this bid package. The Attestations Affidavit form shall be submitted to Facility Planning and Control within 10 days after the opening of bids.

ARTICLE 8

PERFORMANCE AND PAYMENT BOND

8.1 Bond Required

8.1.1 The Contractor shall furnish and pay for a Performance and Payment Bond written by a company licensed to do business in Louisiana, which shall be signed by the surety's agent or attorney-in-fact, in an amount equal to 100% of the Contract amount. Surety must be listed currently on the U. S. Department of Treasury Financial Management Service List (Treasury List) as approved for an amount equal to or greater than the contract amount, or must be an insurance company domiciled in Louisiana or owned by Louisiana residents. If surety is qualified other than by listing on the Treasury list, the contract amount may not exceed fifteen percent of policyholders' surplus as shown by surety's most

recent financial statements filed with the Louisiana Department of Insurance and may not exceed the amount of \$500,000. However, a Louisiana domiciled insurance company with at least an A-rating in the latest printing of the A. M. Best's Key Rating Guide shall not be subject to the \$500,000 limitation, provided that the contract amount does not exceed ten percent of policyholders' surplus as shown in the latest A. M. Best's Key Rating Guide nor fifteen percent of policyholders' surplus as shown by surety's most recent financial statements filed with the Louisiana Department of Insurance. The Bond shall be signed by the surety's agent or attorney-in-fact. The Bond shall be in favor of the Coastal Protection and Restoration Authority.

8.2 Time of Delivery and Form of Bond

8.2.1 The Bidder shall deliver the required bond to the Owner simultaneous with the execution of the Contract.

8.2.2 Bond shall be in the form furnished by the Coastal Protection and Restoration Authority, entitled CONTRACT BETWEEN OWNER AND CONTRACTOR AND PERFORMANCE AND PAYMENT BOND, a copy of which is included in the Bid Documents.

8.2.3 The Bidder shall require the Attorney-in-Fact who executes the required bond on behalf of the surety to affix thereto a certified and current copy of his power of Attorney.

stamped by the Secretary of State, a certified copy of the minutes of the corporation or partnership meeting which authorized the party executing the bid to sign on behalf of the Contractor.

9.2.2 In accordance with Louisiana Law, when the Contract is awarded, the successful Bidder shall, at the time of the signing of the Contract, execute the Non-Collusion Affidavit included in the Contract Documents

9.2.3 When this project is financed either partially or entirely with State Bonds, the award of this Contract is contingent upon the sale of bonds by the State Bond Commission. The State shall incur no obligation to the Contractor until the Contract between Owner and Contractor is duly executed.

ARTICLE 9

FORM OF AGREEMENT BETWEEN OWNER AND CONTRACTOR

9.1 Form to be Used

9.1.1 Form of the Contract to be used shall be furnished by the Coastal Protection and Restoration Authority, an example of which is bound in the Bid Documents.

9.2 Award

9.2.1 Before award of the Contract, the successful Bidder shall furnish to the Owner a copy of a Disclosure of Ownership Affidavit

BID FORM

LOUISIANA UNIFORM PUBLIC WORK BID FORM

TO: Facility Planning and Control
Post Office Box 94095
Claiborne Building
Baton Rouge, LA 70804
(Owner to provide name and address of owner)

BID FOR: Franklin Canal
Flood Protection System
Phase II
Pump Station
(Owner to provide name of project and other identifying information)

The undersigned bidder hereby declares and represents that she/he; a) has carefully examined and understands the Bidding Documents, b) has not received, relied on, or based his bid on any verbal instructions contrary to the Bidding Documents or any addenda, c) has personally inspected and is familiar with the project site, and hereby proposes to provide all labor, materials, tools, appliances and facilities as required to perform, in a workmanlike manner, all work and services for the construction and completion of the referenced project, all in strict accordance with the Bidding Documents prepared by: CB&I and dated: August 2013
(Owner to provide name of entity preparing bidding documents.)

Bidders must acknowledge all addenda. The Bidder acknowledges receipt of the following **ADDENDA:** (Enter the number the Designer has assigned to each of the addenda that the Bidder is acknowledging) _____ .

TOTAL BASE BID: For all work required by the Bidding Documents (including any and all unit prices designated "Base Bid" * but not alternates) the sum of: _____ Dollars (\$ _____)

ALTERNATES: For any and all work required by the Bidding Documents for Alternates including any and all unit prices designated as alternates in the unit price description.

Alternate No. 1 *(Pump Station and Appurtenances, Add)* for the lump sum of: _____ Dollars (\$ _____)

Alternate No. 2 *(Pump Station and Appurtenances, Add)* for the lump sum of: _____ Dollars (\$ _____)

Alternate No. 3 *(Pump Station and Appurtenances, Add)* for the lump sum of: _____ Dollars (\$ _____)

NAME OF BIDDER: _____

ADDRESS OF BIDDER: _____

LOUISIANA CONTRACTOR'S LICENSE NUMBER: _____

NAME OF AUTHORIZED SIGNATORY OF BIDDER: _____

TITLE OF AUTHORIZED SIGNATORY OF BIDDER: _____

SIGNATURE OF AUTHORIZED SIGNATORY OF BIDDER **: _____

DATE: _____

* The Unit Price Form shall be used if the contract includes unit prices. Otherwise it is not required and need not be included with the form. The number of unit prices that may be included is not limited and additional sheets may be included if needed.

** If someone other than a corporate officer signs for the Bidder/Contractor, a copy of a corporate resolution or other signature authorization shall be required for submission of bid. Failure to include a copy of the appropriate signature authorization, if required, may result in the rejection of the bid unless bidder has complied with La. R.S. 38:2212(A)(1)(c) or RS 38:2212(O) .

BID SECURITY in the form of a bid bond, certified check or cashier's check as prescribed by LA RS 38:2218.A is attached to and made a part of this bid.

LOUISIANA UNIFORM PUBLIC WORK BID FORM

UNIT PRICE FORM

TO: Facility Planning and Control
Post Office Box 94095
Claiborne Building
Baton Rouge, LA 70804
(Owner to provide name and address of owner)

BID FOR: Franklin Canal
Flood Protection System
Phase II
Pump Station
(Owner to provide name of project and other identifying information)

UNIT PRICES: This form shall be used for any and all work required by the Bidding Documents and described as unit prices. Amounts shall be stated in figures and only in figures.

DESCRIPTION: <input checked="" type="checkbox"/> Base Bid or <input type="checkbox"/> Alt.# ___ Mobilization & Demobilization				
REF. NO.	QUANTITY:	UNIT OF MEASURE:	UNIT PRICE	UNIT PRICE EXTENSION (<i>Quantity times Unit Price</i>)
1	1	Lump Sum		

DESCRIPTION: <input checked="" type="checkbox"/> Base Bid or <input type="checkbox"/> Alt.# ___ Surveying				
REF. NO.	QUANTITY:	UNIT OF MEASURE:	UNIT PRICE	UNIT PRICE EXTENSION (<i>Quantity times Unit Price</i>)
2	1	Lump Sum		

DESCRIPTION: <input checked="" type="checkbox"/> Base Bid or <input type="checkbox"/> Alt.# ___ Exterior Signage				
REF. NO.	QUANTITY:	UNIT OF MEASURE:	UNIT PRICE	UNIT PRICE EXTENSION (<i>Quantity times Unit Price</i>)
3	2	Each		

DESCRIPTION: <input checked="" type="checkbox"/> Base Bid or <input type="checkbox"/> Alt.# ___ Geotextile Separator				
REF. NO.	QUANTITY:	UNIT OF MEASURE:	UNIT PRICE	UNIT PRICE EXTENSION (<i>Quantity times Unit Price</i>)
4	244	Square Yard		

DESCRIPTION: <input checked="" type="checkbox"/> Base Bid or <input type="checkbox"/> Alt.# ___ Temporary Silt Fencing				
REF. NO.	QUANTITY:	UNIT OF MEASURE:	UNIT PRICE	UNIT PRICE EXTENSION (<i>Quantity times Unit Price</i>)
5	620	Linear Foot		

DESCRIPTION: <input checked="" type="checkbox"/> Base Bid or <input type="checkbox"/> Alt.# ___ 18" Square Precast Prestressed Concrete (PPC) Piles				
REF. NO.	QUANTITY:	UNIT OF MEASURE:	UNIT PRICE	UNIT PRICE EXTENSION (<i>Quantity times Unit Price</i>)
6	841	Linear Foot		

DESCRIPTION: <input checked="" type="checkbox"/> Base Bid or <input type="checkbox"/> Alt.# ___ 12" Diameter Steel Pipe Piles				
REF. NO.	QUANTITY:	UNIT OF MEASURE:	UNIT PRICE	UNIT PRICE EXTENSION (<i>Quantity times Unit Price</i>)
7	144	Linear Foot		

DESCRIPTION: <input checked="" type="checkbox"/> Base Bid or <input type="checkbox"/> Alt.# ___ Articulated Concrete Block Revetment				
REF. NO.	QUANTITY:	UNIT OF MEASURE:	UNIT PRICE	UNIT PRICE EXTENSION (<i>Quantity times Unit Price</i>)
8	637	Square Foot		

LOUISIANA UNIFORM PUBLIC WORK BID FORM

UNIT PRICE FORM

TO: Facility Planning and Control
Post Office Box 94095
Claiborne Building
Baton Rouge, LA 70804
(Owner to provide name and address of owner)

BID FOR: Franklin Canal
Flood Protection System
Phase II
Pump Station
(Owner to provide name of project and other identifying information)

UNIT PRICES: This form shall be used for any and all work required by the Bidding Documents and described as unit prices. Amounts shall be stated in figures and only in figures.

DESCRIPTION: <input checked="" type="checkbox"/> Base Bid or <input type="checkbox"/> Alt.# ___ Precast Concrete Capsills				
REF. NO.	QUANTITY:	UNIT OF MEASURE:	UNIT PRICE	UNIT PRICE EXTENSION (<i>Quantity times Unit Price</i>)
9	3	Each		

DESCRIPTION: <input checked="" type="checkbox"/> Base Bid or <input type="checkbox"/> Alt.# ___ Precast Concrete Deck, 10.5"				
REF. NO.	QUANTITY:	UNIT OF MEASURE:	UNIT PRICE	UNIT PRICE EXTENSION (<i>Quantity times Unit Price</i>)
10	450	Square Foot		

DESCRIPTION: <input checked="" type="checkbox"/> Base Bid or <input type="checkbox"/> Alt.# ___ Precast Concrete Deck, 10"				
REF. NO.	QUANTITY:	UNIT OF MEASURE:	UNIT PRICE	UNIT PRICE EXTENSION (<i>Quantity times Unit Price</i>)
11	276	Square Foot		

DESCRIPTION: <input checked="" type="checkbox"/> Base Bid or <input type="checkbox"/> Alt.# ___ Trash Screen				
REF. NO.	QUANTITY:	UNIT OF MEASURE:	UNIT PRICE	UNIT PRICE EXTENSION (<i>Quantity times Unit Price</i>)
12	1	Lump Sum		

DESCRIPTION: <input checked="" type="checkbox"/> Base Bid or <input type="checkbox"/> Alt.# ___ Pre-engineered Metal Building 18' x 25'				
REF. NO.	QUANTITY:	UNIT OF MEASURE:	UNIT PRICE	UNIT PRICE EXTENSION (<i>Quantity times Unit Price</i>)
13	1	Lump Sum		

DESCRIPTION: <input checked="" type="checkbox"/> Base Bid or <input type="checkbox"/> Alt.# ___ Connecting Walkway (Platform to Floodwall Walkway)				
REF. NO.	QUANTITY:	UNIT OF MEASURE:	UNIT PRICE	UNIT PRICE EXTENSION (<i>Quantity times Unit Price</i>)
14	1	Lump Sum		

DESCRIPTION: <input checked="" type="checkbox"/> Base Bid or <input type="checkbox"/> Alt.# ___ Pump Station Handrail				
REF. NO.	QUANTITY:	UNIT OF MEASURE:	UNIT PRICE	UNIT PRICE EXTENSION (<i>Quantity times Unit Price</i>)
15	43	Linear Foot		

DESCRIPTION: <input checked="" type="checkbox"/> Base Bid or <input type="checkbox"/> Alt.# ___ Pump System				
REF. NO.	QUANTITY:	UNIT OF MEASURE:	UNIT PRICE	UNIT PRICE EXTENSION (<i>Quantity times Unit Price</i>)
16	2	Each		

LOUISIANA UNIFORM PUBLIC WORK BID FORM

UNIT PRICE FORM

TO: Facility Planning and Control
Post Office Box 94095
Claiborne Building
Baton Rouge, LA 70804
(Owner to provide name and address of owner)

BID FOR: Franklin Canal
Flood Protection System
Phase II
Pump Station
(Owner to provide name of project and other identifying information)

UNIT PRICES: This form shall be used for any and all work required by the Bidding Documents and described as unit prices. Amounts shall be stated in figures and only in figures.

DESCRIPTION:	■ Base Bid or □ Alt.# ___ Discharge Pipe System, Pump 1			
REF. NO.	QUANTITY:	UNIT OF MEASURE:	UNIT PRICE	UNIT PRICE EXTENSION (<i>Quantity times Unit Price</i>)
17	1	Lump Sum		

DESCRIPTION:	■ Base Bid or □ Alt.# ___ Discharge Pipe System, Pump 2			
REF. NO.	QUANTITY:	UNIT OF MEASURE:	UNIT PRICE	UNIT PRICE EXTENSION (<i>Quantity times Unit Price</i>)
18	1	Lump Sum		

DESCRIPTION:	■ Base Bid or □ Alt.# ___ Natural Gas Supply			
REF. NO.	QUANTITY:	UNIT OF MEASURE:	UNIT PRICE	UNIT PRICE EXTENSION (<i>Quantity times Unit Price</i>)
19	1	Lump Sum		

DESCRIPTION:	■ Base Bid or □ Alt.# ___ Electrical Service and Amenities			
REF. NO.	QUANTITY:	UNIT OF MEASURE:	UNIT PRICE	UNIT PRICE EXTENSION (<i>Quantity times Unit Price</i>)
20	1	Lump Sum		

DESCRIPTION:	■ Base Bid or □ Alt.# ___ Discharge Pipe Supports, Flood Side			
REF. NO.	QUANTITY:	UNIT OF MEASURE:	UNIT PRICE	UNIT PRICE EXTENSION (<i>Quantity times Unit Price</i>)
21	1	Lump Sum		

DESCRIPTION:	■ Base Bid or □ Alt.# ___ Discharge Pipe Supports, Protected Side			
REF. NO.	QUANTITY:	UNIT OF MEASURE:	UNIT PRICE	UNIT PRICE EXTENSION (<i>Quantity times Unit Price</i>)
22	2	Each		

DESCRIPTION:	■ Base Bid or □ Alt.# ___ Discharge Pipe Supports, Under Deck			
REF. NO.	QUANTITY:	UNIT OF MEASURE:	UNIT PRICE	UNIT PRICE EXTENSION (<i>Quantity times Unit Price</i>)
23	2	Each		

DESCRIPTION:	■ Base Bid or □ Alt.# ___ Seeding and Fertilizing			
REF. NO.	QUANTITY:	UNIT OF MEASURE:	UNIT PRICE	UNIT PRICE EXTENSION (<i>Quantity times Unit Price</i>)
24	1.1	Acre		

LOUISIANA UNIFORM PUBLIC WORK BID FORM

UNIT PRICE FORM

TO: Facility Planning and Control
Post Office Box 94095
Claiborne Building
Baton Rouge, LA 70804
(Owner to provide name and address of owner)

BID FOR: Franklin Canal
Flood Protection System
Phase II
Pump Station
(Owner to provide name of project and other identifying information)

UNIT PRICES: This form shall be used for any and all work required by the Bidding Documents and described as unit prices. Amounts shall be stated in figures and only in figures.

DESCRIPTION: <input checked="" type="checkbox"/> Base Bid or <input type="checkbox"/> Alt.# <u> </u> Placement of Onsite Riprap				
REF. NO.	QUANTITY:	UNIT OF MEASURE:	UNIT PRICE	UNIT PRICE EXTENSION (<i>Quantity times Unit Price</i>)
25	1	Lump Sum		

DESCRIPTION: <input checked="" type="checkbox"/> Base Bid or <input type="checkbox"/> Alt.# <u> </u> East Side Walkway				
REF. NO.	QUANTITY:	UNIT OF MEASURE:	UNIT PRICE	UNIT PRICE EXTENSION (<i>Quantity times Unit Price</i>)
26	1	Lump Sum		

DESCRIPTION: <input type="checkbox"/> Base Bid or <input checked="" type="checkbox"/> Alt.# <u>1</u> Deck Opening Cover Plate				
REF. NO.	QUANTITY:	UNIT OF MEASURE:	UNIT PRICE	UNIT PRICE EXTENSION (<i>Quantity times Unit Price</i>)
27	2	Each		

DESCRIPTION: <input type="checkbox"/> Base Bid or <input checked="" type="checkbox"/> Alt.# <u>1</u> Geotextile Separator				
REF. NO.	QUANTITY:	UNIT OF MEASURE:	UNIT PRICE	UNIT PRICE EXTENSION (<i>Quantity times Unit Price</i>)
28	58	Square Yard		

DESCRIPTION: <input type="checkbox"/> Base Bid or <input checked="" type="checkbox"/> Alt.# <u>1</u> 18" Square Precast Prestressed Concrete (PPC) Piles				
REF. NO.	QUANTITY:	UNIT OF MEASURE:	UNIT PRICE	UNIT PRICE EXTENSION (<i>Quantity times Unit Price</i>)
29	561	Linear Foot		

DESCRIPTION: <input type="checkbox"/> Base Bid or <input checked="" type="checkbox"/> Alt.# <u>1</u> Articulated Concrete Block Revetment				
REF. NO.	QUANTITY:	UNIT OF MEASURE:	UNIT PRICE	UNIT PRICE EXTENSION (<i>Quantity times Unit Price</i>)
30	525	Square Foot		

DESCRIPTION: <input type="checkbox"/> Base Bid or <input checked="" type="checkbox"/> Alt.# <u>1</u> Precast Concrete Capsills				
REF. NO.	QUANTITY:	UNIT OF MEASURE:	UNIT PRICE	UNIT PRICE EXTENSION (<i>Quantity times Unit Price</i>)
31	2	Each		

DESCRIPTION: <input type="checkbox"/> Base Bid or <input checked="" type="checkbox"/> Alt.# <u>1</u> Precast Concrete Deck, 10.5"				
REF. NO.	QUANTITY:	UNIT OF MEASURE:	UNIT PRICE	UNIT PRICE EXTENSION (<i>Quantity times Unit Price</i>)
32	450	Square Foot		

LOUISIANA UNIFORM PUBLIC WORK BID FORM

UNIT PRICE FORM

TO: Facility Planning and Control
Post Office Box 94095
Claiborne Building
Baton Rouge, LA 70804
(Owner to provide name and address of owner)

BID FOR: Franklin Canal
Flood Protection System
Phase II
Pump Station
(Owner to provide name of project and other identifying information)

UNIT PRICES: This form shall be used for any and all work required by the Bidding Documents and described as unit prices. Amounts shall be stated in figures and only in figures.

DESCRIPTION: <input type="checkbox"/> Base Bid or <input checked="" type="checkbox"/> Alt.# <u>1</u> Precast Concrete Deck, 10"				
REF. NO.	QUANTITY:	UNIT OF MEASURE:	UNIT PRICE	UNIT PRICE EXTENSION (<i>Quantity times Unit Price</i>)
33	276	Square Foot		

DESCRIPTION: <input type="checkbox"/> Base Bid or <input checked="" type="checkbox"/> Alt.# <u>1</u> Deduction for Pre-engineered Metal Building 18' x 25'				
REF. NO.	QUANTITY:	UNIT OF MEASURE:	UNIT PRICE	UNIT PRICE EXTENSION (<i>Quantity times Unit Price</i>)
34	1	Lump Sum		

DESCRIPTION: <input type="checkbox"/> Base Bid or <input checked="" type="checkbox"/> Alt.# <u>1</u> Pre-engineered Metal Building 18' x 50'				
REF. NO.	QUANTITY:	UNIT OF MEASURE:	UNIT PRICE	UNIT PRICE EXTENSION (<i>Quantity times Unit Price</i>)
35	1	Lump Sum		

DESCRIPTION: <input type="checkbox"/> Base Bid or <input checked="" type="checkbox"/> Alt.# <u>1</u> Pump Station Handrail				
REF. NO.	QUANTITY:	UNIT OF MEASURE:	UNIT PRICE	UNIT PRICE EXTENSION (<i>Quantity times Unit Price</i>)
36	25	Linear Foot		

DESCRIPTION: <input type="checkbox"/> Base Bid or <input checked="" type="checkbox"/> Alt.# <u>1</u> Discharge Pipe Supports, Protected Side				
REF. NO.	QUANTITY:	UNIT OF MEASURE:	UNIT PRICE	UNIT PRICE EXTENSION (<i>Quantity times Unit Price</i>)
37	7	Each		

DESCRIPTION: <input type="checkbox"/> Base Bid or <input checked="" type="checkbox"/> Alt.# <u>1</u> Discharge Pipe Supports, Under Deck				
REF. NO.	QUANTITY:	UNIT OF MEASURE:	UNIT PRICE	UNIT PRICE EXTENSION (<i>Quantity times Unit Price</i>)
38	2	Each		

DESCRIPTION: <input type="checkbox"/> Base Bid or <input checked="" type="checkbox"/> Alt.# <u>1</u> Trash Screen				
REF. NO.	QUANTITY:	UNIT OF MEASURE:	UNIT PRICE	UNIT PRICE EXTENSION (<i>Quantity times Unit Price</i>)
39	1	Lump Sum		

DESCRIPTION: <input type="checkbox"/> Base Bid or <input checked="" type="checkbox"/> Alt.# <u>1</u> 12" Diameter Steel Pipe Piles				
REF. NO.	QUANTITY:	UNIT OF MEASURE:	UNIT PRICE	UNIT PRICE EXTENSION (<i>Quantity times Unit Price</i>)
40	506	Linear Foot		

LOUISIANA UNIFORM PUBLIC WORK BID FORM

UNIT PRICE FORM

TO: Facility Planning and Control
Post Office Box 94095
Claiborne Building
Baton Rouge, LA 70804
(Owner to provide name and address of owner)

BID FOR: Franklin Canal
Flood Protection System
Phase II
Pump Station
(Owner to provide name of project and other identifying information)

UNIT PRICES: This form shall be used for any and all work required by the Bidding Documents and described as unit prices. Amounts shall be stated in figures and only in figures.

DESCRIPTION: <input type="checkbox"/> Base Bid or <input checked="" type="checkbox"/> Alt.# <u>1</u> Electrical Service and Amenities				
REF. NO.	QUANTITY:	UNIT OF MEASURE:	UNIT PRICE	UNIT PRICE EXTENSION (<i>Quantity times Unit Price</i>)
41	1	Lump Sum		

DESCRIPTION: <input type="checkbox"/> Base Bid or <input checked="" type="checkbox"/> Alt.# <u>1</u> Deduction for East Side Walkway				
REF. NO.	QUANTITY:	UNIT OF MEASURE:	UNIT PRICE	UNIT PRICE EXTENSION (<i>Quantity times Unit Price</i>)
42	1	Lump Sum		

DESCRIPTION: <input type="checkbox"/> Base Bid or <input checked="" type="checkbox"/> Alt.# <u>2</u> Deduction for Deck Opening Cover Plate				
REF. NO.	QUANTITY:	UNIT OF MEASURE:	UNIT PRICE	UNIT PRICE EXTENSION (<i>Quantity times Unit Price</i>)
43	1	Each		

DESCRIPTION: <input type="checkbox"/> Base Bid or <input checked="" type="checkbox"/> Alt.# <u>2</u> Pump System				
REF. NO.	QUANTITY:	UNIT OF MEASURE:	UNIT PRICE	UNIT PRICE EXTENSION (<i>Quantity times Unit Price</i>)
44	1	Each		

DESCRIPTION: <input type="checkbox"/> Base Bid or <input checked="" type="checkbox"/> Alt.# <u>2</u> Discharge Pipe System, Pump 3				
REF. NO.	QUANTITY:	UNIT OF MEASURE:	UNIT PRICE	UNIT PRICE EXTENSION (<i>Quantity times Unit Price</i>)
45	1	Lump Sum		

DESCRIPTION: <input type="checkbox"/> Base Bid or <input checked="" type="checkbox"/> Alt.# <u>3</u> Deduction for Deck Opening Cover Plate				
REF. NO.	QUANTITY:	UNIT OF MEASURE:	UNIT PRICE	UNIT PRICE EXTENSION (<i>Quantity times Unit Price</i>)
46	1	Each		

DESCRIPTION: <input type="checkbox"/> Base Bid or <input checked="" type="checkbox"/> Alt.# <u>3</u> Pump System				
REF. NO.	QUANTITY:	UNIT OF MEASURE:	UNIT PRICE	UNIT PRICE EXTENSION (<i>Quantity times Unit Price</i>)
47	1	Each		

DESCRIPTION: <input type="checkbox"/> Base Bid or <input checked="" type="checkbox"/> Alt.# <u>3</u> Discharge Pipe System, Pump 4				
REF. NO.	QUANTITY:	UNIT OF MEASURE:	UNIT PRICE	UNIT PRICE EXTENSION (<i>Quantity times Unit Price</i>)
48	1	Lump Sum		

Wording for "DESCRIPTION" is to be provided by the Owner.

All quantities are estimated. The contractor will be paid based upon actual quantities as verified by the Owner

BID BOND

BID BOND
FOR
COASTAL PROTECTION AND RESTORATION AUTHORITY PROJECTS

Date: _____

KNOW ALL MEN BY THESE PRESENTS:

That _____ of _____, as Principal, and _____, as Surety, are held and firmly bound unto the State of Louisiana, Coastal Protection and Restoration Authority (Obligee), in the full and just sum of five (5%) percent of the total amount of this proposal, including all alternates, lawful money of the United States, for payment of which sum, well and truly be made, we bind ourselves, our heirs, executors, administrators, successors and assigns, jointly and severally firmly by these presents.

Surety represents that it is listed on the current U. S. Department of the Treasury Financial Management Service list of approved bonding companies as approved for an amount equal to or greater that the amount for which it obligates itself in this instrument or that it is a Louisiana domiciled insurance company with at least an A - rating in the latest printing of the A. M. Best's Key Rating Guide. If surety qualifies by virtue of its Best's listing, the Bond amount may not exceed ten percent of policyholders' surplus as shown in the latest A. M. Best's Key Rating Guide.

Surety further represents that it is licensed to do business in the State of Louisiana and that this Bond is signed by surety's agent or attorney-in-fact. This Bid Bond is accompanied by appropriate power of attorney.

THE CONDITION OF THIS OBLIGATION IS SUCH that, whereas said Principal is herewith submitting its proposal to the Obligee on a Contract for:

NOW, THEREFORE, if the said Contract be awarded to the Principal and the Principal shall, within such time as may be specified, enter into the Contract in writing and give a good and sufficient bond to secure the performance of the terms and conditions of the Contract with surety acceptable to the Obligee, then this obligation shall be void; otherwise this obligation shall become due and payable.

PRINCIPAL (BIDDER)

SURETY

BY: _____
AUTHORIZED OFFICER-OWNER-PARTNER

BY: _____
AGENT OR ATTORNEY-IN-FACT(SEAL)

**CONTRACT BETWEEN OWNER AND CONTRACTOR AND
PERFORMANCE AND PAYMENT BOND**

FOR INFORMATION ONLY

This document will be prepared by the Coastal Protection and Restoration Authority in the form appropriate for the project.

CONTRACT BETWEEN OWNER AND CONTRACTOR AND PERFORMANCE AND PAYMENT BOND

This agreement entered into this _____ day of _____, 2013, by (CONTRACTOR NAME) hereinafter called the "Contractor", whose business address is _____, and the State of Louisiana Coastal Protection and Restoration Authority, herein represented by its Executive Director executing this contract, and hereinafter called the "Owner".

Witnesseth that the Contractor and the Owner, in consideration of premises and the mutual covenants; consideration and agreement herein contained, agree as follows:

Statement of Work: The contractor shall furnish all labor and materials and perform all of the work required to build, construct and complete in a thorough and workmanlike manner:

Project No. _____
State ID No. _____ Site Code _____

in strict accordance with Contract Documents prepared by Owner.

It is recognized by the parties herein that said Contract Documents, including by way of example and not of limitation, the Plans, Specifications (including General Provisions, Special Provisions, and Technical Specifications), Any Addenda thereto, Instructions To Bidders, this Contract, Advertisement For Bids, Affidavit, Bid Form, Bonds (Bid, Performance, and Payment), any Submitted Post-Bid Documentation, Notice of Award, Notice to Proceed, Change Orders, and Claims, if any, impose duties and obligations upon the parties herein, and said parties thereby agree that they shall be bound by said duties and obligations. For these purposes, all of the provisions contained in the aforementioned Contract Documents are incorporated herein by reference with the same force and effect as though said Contract Documents were herein set out in full.

Time for Completion: The work shall be commenced on a date to be specified in a written order of the Owner and shall be completed within _____ consecutive calendar days from and after the said date.

Liquidated Damages: Contractor shall be assessed Liquidated Damages in the amount of \$ _____ per day for each consecutive calendar day which work is not complete beginning with the first day beyond the completion time.

Compensation to be paid to the Contractor: The Owner will pay and the Contractor will accept in full consideration for the performance of the contract the sum of _____ **Dollars (\$)** which sum represents the Contract Price.

Performance and Payment Bond: To these presents personally came and intervened _____, herein acting for _____, a corporation organized and existing under the laws of the State of _____, and duly authorized to transact business in the State of Louisiana, as surety, who declared that having taken cognizance of this contract and of the Construction Documents mentioned herein, he hereby in his capacity as its Attorney in Fact obligates his said company, as Surety for the said Contractor, unto the said Owner, up to the sum of _____ **Dollars (\$)**. By issuance of this bond, the surety acknowledges they are in compliance with R.S. 38:2219.

The condition of this performance and payment bond shall be that should the Contractor herein not perform the contract in accordance with the terms and conditions hereof, or should said Contractor not fully indemnify and save harmless the Owner, from all cost and damages which he may suffer by said Contractor's non-performance or should said Contractor not pay all persons who have and fulfill obligations to perform labor and/or furnish materials in the prosecution of the work provided for herein, including by way of example workmen, laborers, mechanics, and furnishers of materials, machinery, equipment and fixtures, then said Surety agrees and is bound to so perform the contract and make said payment(s).

Provided, that any alterations which may be made in the terms of the contract or in the work to be done under it, or the giving by the Owner of any extensions of time for the performance of the contract, or any other forbearance on the part of either the Owner or the Contractor to the other shall not in any way release the Contractor or the Surety from their liability hereunder, notice to the Surety of any such alterations, extensions or other forbearance being hereby waived.

The Contractor agrees to abide by the requirements of the following as applicable: Title VI and VII of the Civil Rights Act of 1964, as amended by the Equal Opportunity Act of 1972, Federal Executive Order 11246, the Federal Rehabilitation Act of 1973, as amended, the Vietnam Era Veteran's Readjustment Assistance Act of 1974, Title IX of the Education Amendments of 1972, the Age Act of 1972, and contractor agrees to abide by the requirements of the Americans with Disabilities Act of 1990.

Contractor agrees not to discriminate in its employment practices, and will render services under this contract without regard to race, color, sex, religion, national origin, genetic information, age or disabilities. Any act of discrimination committed by Contractor or failure to comply with these statutory obligations when applicable shall be grounds for termination of this contract.

In Witness whereof, the parties hereto on the day and year first above written have executed this agreement in eight (8) counterparts, each of which shall, without proof or accountancy for the other counterparts, be deemed an original thereof.

WITNESSES:

**STATE OF LOUISIANA
COASTAL PROTECTION AND
RESTORATION AUTHORITY**

BY: _____
Jerome Zeringue, Executive Director

BY: _____

SURETY: _____

BY: _____
ATTORNEY IN FACT

ADDRESS

TELEPHONE NUMBER

STATE OF LOUISIANA
PARISH OF _____

PROJECT NO.

NAME

LOCATION:

A F F I D A V I T

Before me, the undersigned authority, duly commissioned and qualified within and for the State and Parish aforesaid, personally came and appeared _____ representing who, being by me first duly sworn deposed and said that he has read this affidavit and does hereby agree under oath to comply with all provisions herein as follows:

PART I.

Section 2224 of Part II of Chapter 10 of Title 38 of the Louisiana Revised Statutes, as amended.

(1) That affiant employed no person, corporation, firm, association, or other organization, either directly or indirectly, to secure the public contract under which he received payment, other than persons regularly employed by the affiant whose services in connection with the construction, alteration or demolition of the public building or project or in securing the public contract were in the regular course of their duties for affiant; and

(2) That no part of the Contract price received by affiant was paid or will be paid to any person, corporation, firm, association, or other organization for soliciting the Contract, other than the payment of their normal compensation to persons regularly employed by the affiant whose services in connection with the construction, alteration or demolition of the public building or project were in the regular course of their duties for affiant.

PART II.

Section 2190 of Part I of Chapter 10 of Title 38 of the Louisiana Revised Statutes, as amended.

That affiant, if an architect or engineer, or representative thereof, does not own a substantial financial interest, either directly or indirectly, in any corporation, firm, partnership, or other organization which supplies materials for the construction of a public work when the architect or engineer has performed architectural or engineering services, either directly or indirectly, in connection with the public work for which the materials are being supplied.

For the purposes of this Section, a "substantial financial interest" shall exclude any interest in stock being traded on the American Stock Exchange or the New York Stock Exchange.

That affiant, if subject to the provisions of this section, does hereby agree to be subject to the penalties involved for the violation of this section.

AFFIANT

SWORN TO AND SUBSCRIBED BEFORE ME THIS _____ DAY OF _____, 2013.

NOTARY

ATTESTATIONS AFFIDAVIT

FRANKLIN CANAL FLOOD PROTECTION SYSTEM
PHASE II – PUMP STATION

TV-52

Name of Project

Project No.

STATE OF _____

PARISH OF _____

ATTESTATIONS AFFIDAVIT

Before me, the undersigned notary public, duly commissioned and qualified in and for the parish and state aforesaid, personally came and appeared Affiant, who after being duly sworn, attested as follows:

LA. R.S. 38:2227 PAST CRIMINAL CONVICTIONS OF BIDDERS

A. No sole proprietor or individual partner, incorporator, director, manager, officer, organizer, or member who has a minimum of a ten percent (10%) ownership in the bidding entity named below has been convicted of, or has entered a plea of guilty or nolo contendere to any of the following state crimes or equivalent federal crimes:

- | | |
|---------------------------------------|-----------------------------------|
| (a) Public bribery (R.S. 14:118) | (c) Extortion (R.S. 14:66) |
| (b) Corrupt influencing (R.S. 14:120) | (d) Money laundering (R.S. 14:23) |

B. Within the past five years from the project bid date, no sole proprietor or individual partner, incorporator, director, manager, officer, organizer, or member who has a minimum of a ten percent (10%) ownership in the bidding entity named below has been convicted of, or has entered a plea of guilty or nolo contendere to any of the following state crimes or equivalent federal crimes, during the solicitation or execution of a contract or bid awarded pursuant to the provisions of Chapter 10 of Title 38 of the Louisiana Revised Statutes:

- | | |
|--|--|
| (a) Theft (R.S. 14:67) | (f) Bank fraud (R.S. 14:71.1) |
| (b) Identity Theft (R.S. 14:67.16) | (g) Forgery (R.S. 14:72) |
| (c) Theft of a business record
(R.S.14:67.20) | (h) Contractors; misapplication of
payments (R.S. 14:202) |
| (d) False accounting (R.S. 14:70) | (i) Malfeasance in office (R.S. 14:134) |
| (e) Issuing worthless checks
(R.S. 14:71) | |

LA. R.S. 38:2212.10 Verification of Employees

- A. At the time of bidding, Appearer is registered and participates in a status verification system to verify that all new hires in the state of Louisiana are legal citizens of the United States or are legal aliens.
- B. If awarded the contract, Appearer shall continue, during the term of the contract, to utilize a status verification system to verify the legal status of all new employees in the state of Louisiana.
- C. If awarded the contract, Appearer shall require all subcontractors to submit to it a sworn affidavit verifying compliance with Paragraphs (A) and (B) of this Subsection.

FRANKLIN CANAL FLOOD PROTECTION SYSTEM
PHASE II – PUMP STATION

TV-52

Name of Project

Project No.

LA. R.S. 23:1726(B) Certification Regarding Unpaid Workers Compensation Insurance

- A. R.S. 23:1726 prohibits any entity against whom an assessment under Part X of Chapter 11 of Title 23 of the Louisiana Revised Statutes of 1950 (Alternative Collection Procedures & Assessments) is in effect, and whose right to appeal that assessment is exhausted, from submitting a bid or proposal for or obtaining any contract pursuant to Chapter 10 of Title 38 of the Louisiana Revised Statutes of 1950 and Chapters 16 and 17 of Title 39 of the Louisiana Revised Statutes of 1950.
- B. By signing this bid /proposal, Affiant certifies that no such assessment is in effect against the bidding / proposing entity.

NAME OF BIDDER

NAME OF AUTHORIZED SIGNATORY OF BIDDER

DATE

TITLE OF AUTHORIZED SIGNATORY OF BIDDER

**SIGNATURE OF AUTHORIZED
SIGNATORY OF BIDDER/AFFIANT**

Sworn to and subscribed before me by Affiant on the ____ day of _____, 20__ .

Notary Public

PART I
GENERAL PROVISIONS

PART I GENERAL PROVISIONS

GP-1 DEFINITION OF TERMS

Whenever used in the Bidding Requirements or Contract Documents and printed with initial capital letters, the terms listed below will have the meanings indicated which are applicable to the singular or plural thereof. In addition to terms specifically defined, terms with initial capital letters in the Contract Documents include references to identified articles and paragraphs and the titles of other documents or forms.

Unless stated otherwise in the Contract Documents, words or phrases which have a well-known technical or construction industry or trade meaning are used in the Contract Documents in accordance with such recognized meaning.

- a. Acceptance: A written approval from the Engineer which certifies that specific items of work in the Contract have been completed and/or obligations have been fulfilled by the Contractor.
- b. Addenda: Those written or graphic documents which are issued prior to opening of Bids in accordance with the Bidding Requirements and clarify or change the bidding requirements or the proposed Contract Documents.
- c. Application of Payment: That form which is used by the Contractor to request partial and final payment and is deemed acceptable to the Owner. It shall be accompanied by any supporting documentation required by the Contract Documents.
- d. A.S.T.M.: American Society for Testing and Materials.
- e. Bid: An offer or proposal submitted on the prescribed form setting forth the prices for the Work.
- f. Bidder: The person, association of persons, firm, or corporation submitting a proposal for the Work.
- g. Bidding Requirements: The Advertisement for Bids, Instructions to Bidders, Form of Bid Security, if any, and Bid Form with any supplements.
- h. Change Order: A written order which is submitted to the Contractor, signed by the Owner, and authorizes an addition, deletion, or revision in the Work, or an adjustment in the contract price or the contract time issued after the effective date of the Contract.
- i. Claim: A written demand or assertion by Owner or Contractor seeking an adjustment of Contract Price or Contract Times, or both or other relief with respect to the terms of the Contract.
- j. Contract: The written agreement between the Owner and the Contractor which defines the work to be completed and shall be understood to also include all Contract Documents.

- k. Contract Documents: The Contract, all addenda which pertains to the Contract Documents, Bid Documents and specified Attachments accompanying the Bid and any post-bid documentation submitted prior to the Notice of Award, Contractor's Bid when attached as an exhibit to the Agreement, the Bonds (Bid and Performance/Payment), General Provisions, Special Provisions, Technical Specifications, Plans, and all Field or Change Orders issued after the execution of the Agreement. Shop Drawings and other submittals by the Contractor are not Contract Documents.
- l. Contract Price: The moneys payable by the Owner to the Contractor for the Work in accordance with the Contract Documents as stated in the Contract.
- m. Contract Time: The number of calendar days specified in the Contract for completion of the Work, together with any extensions authorized through change orders.
- n. Contractor: The person, association of persons, firm, or corporation entering into the duly awarded Contract.
- o. Contracting Agency: The State of Louisiana, Coastal Protection and Restoration Authority (CPRA).
- p. Day: When any period of time is referred to in the Contract Documents using days, it will be computed to exclude the first day and include the last day of such period. If the last day of any such period falls on a Saturday, Sunday, or a legal holiday, that day will be omitted from the computation. A calendar day is measured as twenty-four (24) hour period starting at midnight and ending the following midnight.
- q. Design Report: A written report by the Engineer which provides the design methodology for the Work.
- r. Effective Date of the Contract: The date indicated in the Contract on which it becomes effective.
- s. Engineer: The State of Louisiana, Coastal Protection and Restoration Authority, or its designee.
- t. Equipment: All machinery, implements, and power-tools, in conjunction with the necessary supplies for the operation, upkeep, maintenance, and all other tools and apparatuses necessary for the proper construction and acceptable completion of the Work.
- u. Extension of Contract: Any extension of time for completion of Work beyond the Contract Time which is granted by the Owner, recommended by the Engineer and approved by the Coastal Protection and Restoration Authority in the form of a Change Order.
- v. Federal Sponsor: The federal agency which has been tasked, if applicable, to manage the implementation of the project.
- w. Field Order: A written order issued by the Engineer which requires minor changes in the Work but which does not involve a change in the Contract Price or Contract Time.

- x. Laboratory: The firm, company, or corporation which is used to test materials and is approved for use by the Engineer.
- y. Laws and Regulations; Laws or Regulations: Any and all applicable laws, rules, regulations, ordinances, codes, and orders of any and all governmental bodies, agencies, authorities, and courts having jurisdiction.
- z. Materials: Any substance used in the Work to build structures, but does not include material used in false work or other temporary structures not incorporated in the Work.
- aa. Milestone: A principal event specified in the Contract Documents relating to an intermediated completion date or time prior to the Contract Times.
- bb. Notice of Award: A written notice to the successful Bidder stating that the Bid has been accepted by the Owner and that the successful Bidder is required to execute the Contract and furnish the Payment and Performance Bond and Non-Collusion Affidavit.
- cc. Notice to Proceed: The written notice to the Contractor by the Owner which provides the starting date for the Contract Time.
- dd. Owner: The Owner is the State of Louisiana (State) which acts through the Contracting Agency.
- ee. Performance and Payment Bond: The approved form of security furnished by the Contractor and Surety for the faithful performance of the Work, and the payment for all labor, materials, and/or obligations incurred by the Contractor in the prosecution thereof.
- ff. Plans: That part of the Contract Documents prepared or approved by the Engineer which graphically shows the scope, intent, and character of the Work to be completed by the Contractor.
- gg. Project Site: The location where the Work is to be performed as stated in the Contract Documents.
- hh. Resident Project Representative: An authorized representative of the Engineer who is responsible to inspect the Work and materials furnished by the Contractor.
- ii. Right-of-way: That entire area reserved for constructing, maintaining, and protecting the proposed improvement, structures, and appurtenances of the Work.
- jj. Samples: Physical examples of materials, equipment, or workmanship that are representative of some portion of the Work and which establish the standards by which such portions of the Work will be judged.
- kk. Shop Drawings: All drawings, diagrams, illustrations, schedules, and other data or information which are specifically prepared or assembled by or for the Contractor and submitted by the Contractor to illustrate some portion of the Work to be performed.

- ll. Specifications: That part of the Contract Documents consisting of written technical descriptions of materials, equipment, systems, standards, and workmanship as applied to the work to be performed and certain administrative details applicable thereto.
- mm. State: The State of Louisiana.
- nn. Structures: Bridges, plugs, weirs, bulkheads, berms, dams, levees, and other miscellaneous construction encountered during the Work and not otherwise classified herein.
- oo. Subcontractor: Any person, association of persons, firm, or corporation who contracts with the Contractor to perform any part of the project covered by the Contract.
- pp. Submittals: Certificates, samples, shop drawings, and all other project data which are submitted to the Engineer in order to verify that the correct products will be installed on the project.
- qq. Successful Bidder: The lowest responsible Bidder whom the Owner makes an award.
- rr. Special Provisions: That part of the Contract Documents which amends or supplements these General Provisions.
- ss. Surety: The corporate body, licensed to do business in Louisiana, bound with and for the Contractor's primary liability, and engages to be responsible for payment of all obligations pertaining to acceptable performance of the Work contracted.
- tt. Temporary Structures: Any non-permanent structure required while engaged in the prosecution of the Contract.
- uu. Work: All work specified herein or indicated on the Plans.
- vv. Work Plan: A written plan by the Contractor that details how the Work will be provided including layout drawings, projected schedule (Initial Progress Schedule), and a list of labor hours, materials, and equipment.

GP-2 BID REQUIREMENTS

The Contract and Bonds which govern the Work shall be performed in accordance with the Plans, Specifications, and the Louisiana Standard Specifications for Roads and Bridges, 2006 edition. The Bidder understands that all quantities for performing the Work have been estimated by the Engineer, and that the Bid shall be the sum of the quantities multiplied by their respective unit rates. The Contract shall be awarded by the Owner through a comparison of all bids. It is the responsibility of each Bidder before submitting a Bid to:

- 2.1. Examine the Bidding Documents including the Plans and Specifications and any Addenda or related data identified in the Bidding Documents;
- 2.2. Visit the Project Site to become familiar with the local conditions if they are believed to affect cost, progress, or the completion of the Work;

- 2.3. Become familiar and satisfied with all federal, state, and local Laws and Regulations that may affect cost, progress, or the completion of the Work;
- 2.4. Study and correlate all information known to the Bidder including observations obtained from Bidder's visits, if any, to the Project Site, with the Bidding Documents;
- 2.5. Submit a written notice to the Engineer within three (3) days regarding any conflicts, errors, ambiguities, or discrepancies discovered in the Bidding Documents and confirm that the written resolution thereof by the Engineer is acceptable to the Bidder; and
- 2.6. Determine that the Bidding Documents are generally sufficient to convey an understanding of all terms and conditions for completing the required Work.

The submission of a Bid will constitute an incontrovertible representation that the Bidder has complied with every requirement of these Specifications. The Bidder shall comply with all other requirements specified in the Advertisement For Bids and the Instruction To Bidders.

GP-3 AVAILABILITY OF PLANS AND SPECIFICATIONS

One (1) set of Plans and Specifications shall be furnished to each Bidder. Three (3) sets of the Plans and Specifications shall be furnished to the Contractor upon award of the Contract. Additional sets may be furnished to the Contractor upon request from the Engineering Division of the Coastal Protection and Restoration Authority, 450 Laurel Street, 11th Floor, Baton Rouge, Louisiana 70801.

GP-4 LAWS, REGULATIONS, STANDARDS, SPECIFICATIONS, AND CODES

Bidders are required to become familiar and remain in compliance with all Federal, State, and local laws, ordinances, and regulations and all orders and decrees of bodies or tribunals having any jurisdiction or authority which may affect those employed for the execution of the Work or which may affect the conduct of the Work. The Contractor shall indemnify the Owner and its representatives against any claim or liability arising from all violations of any laws, bylaws, ordinances, codes, regulations, orders, or decrees, whether by the Contractor or by the Contractor's employees. The filing of a bid will be presumptive evidence that the Bidder has complied with this requirement. The Owner will not be responsible for any inaccurate interpretations or conclusions drawn by the Contractor from information and documentation provided by the Owner.

References to standards, specifications, manuals, or codes of any technical society, organization, or association, or to Laws and Regulations, whether such reference be specific or by implication, may not be in effect at the time of opening the Bids (or on the Effective Date of the Contract if there were no Bids), except as may be otherwise specifically stated in the Contract Documents. No provision of any such standard, specification, manual, or code, or any instruction of a supplier shall be effective to change the duties or responsibilities of the Owner or Engineer, or any of their Subcontractors, consultants, agents, or employees from those set forth in the Bid Documents. No such provision shall be effective to assign to the Owner or Engineer, or any of their consultants, agents, or employees any duty or authority to supervise or direct the performance of the Contractor's obligations or any duty or authority to undertake responsibility inconsistent with the provisions of the Contract Documents.

The obligations imposed by these specifications are in addition to and are not to be construed in any way as a limitation of any rights available to the Engineer or Owner which are otherwise imposed by any laws or regulations or other provisions within the Contract Documents.

The Contractor shall abide by laws set forth in the Davis-Bacon Act of 1931 which states that all laborers and mechanics employed by recipients, the recipient's contractors, or subcontractors on this project shall be paid wages at rates no less than those prevailing on projects of a character similar in the locality as determined by the Secretary of Labor in accordance with Subchapter IV of Chapter 31 of Title 40 United States Code. Additionally, with respect to the labor standards specified in this section, the Secretary of Labor shall have the authority and functions set forth in Reorganization Plan Number 14 of 1950 (64 Stat. 1267; 5 U.S.C. App.) and The Copeland Act of Title 40 (40 U.S.C. § 3145). Prevailing Wage Determination Schedules, as determined by the United States Department of Labor, are provided in the Appendix. Prevailing Wage Determination Schedules are subject to modification by the United States Department of Labor. The Contractor is responsible for utilizing the most current Prevailing Wage Determination Schedule. These documents can be downloaded from the following link: <http://www.wdol.gov/dba.aspx#3>. Modifications to Prevailing Wage Determination Schedules shall be effective if received (or posted) no less than 10 days prior to bid opening.

GP-5 PRE-BID CONFERENCE AND SITE VISIT

A Pre-Bid Conference will be held at the location and on the date provided in the Advertisement For Bids. If the Pre-Bid Conference is stated in the Advertisement for Bids to be a MANDATORY Pre-Bid Conference, bids shall be accepted only from those bidders who attend the Pre-Bid Conference in its entirety. Failure to attend a mandatory Pre-Bid Conference in its entirety will result in a null or void Bid.

A site visit may also be held at the Project Site as specified in the Advertisement For Bids or at the Pre-Bid conference. If held, bidders will be required to furnish their own transportation to the Project Site. Representatives of the Owner and Engineer will attend the Pre-Bid conference and site visit, if held, to discuss the Work.

All questions shall be in writing and faxed or emailed to the Coastal Protection and Restoration contact person listed in the Advertisement For Bids after the Pre-Bid Conference and by the due date announced at the Pre-Bid conference. In order to ensure adequate response time, all questions and/or requests for clarification or interpretation of the Bid Documents should be received by the Coastal Protection and Restoration Authority at least seven days prior to the date for receipt of bids. Oral statements will not be binding or legally effective. The Coastal Protection and Restoration Authority will issue addenda in response to all questions arising at the Pre-Bid Conference and site visit to all prospective Bidders on record. All prospective Bidders on record may contact the Coastal Protection and Restoration Authority contact person for any additional information.

GP-6 NOTICE OF AWARD

The Owner, or its designated bidding agent (Division of Administration, Office of Facility Planning and Control), shall provide written notice to the Successful Bidder stating that the

Owner will sign and deliver the Contract upon compliance with the conditions enumerated therein and within the time specified.

GP-7 NOTICE TO PROCEED AND CONTRACT TIME

The Contractor shall start the Work and begin the Contract Time on the dates provided in the Notice to Proceed. The Work shall be conducted using sufficient labor, materials, and equipment as necessary to ensure completion within the Contract Time. The Contract Time for completion of the Base Bid for the Work is provided in the Instructions To Bidders, unless an extension is granted to the Contract Time as specified in GP-44. If the Bid contains an Alternate Bid(s), and the Alternate Bid(s) is awarded and included in the Contract, the Contract Time associated with the Alternate Bid(s) will be as provided in the Special Provisions.

GP-8 WORK PLAN

The Contractor shall develop a written Work Plan which accounts for all of the construction activities required by the Contract Documents. The Work Plan shall include a list of the individual construction tasks to be completed and the estimated dates for beginning and completing the tasks. It shall also include all other items which are applicable to completing the Work such as, but not limited to, the following:

- a. Typical report form for the Bi-Weekly Progress Meeting;
- b. Typical form for Daily Progress Report;
- c. Hurricane and Severe Storm Plan;
- d. Site-specific Health and Safety Plan;
- e. The delivery method and source(s) of all construction materials (company or producer name, mailing and physical address, phone number, and name of contact person).
- f. The personnel, material, subcontractors, fabricators, suppliers, types of equipment, and equipment staging areas the Contractor proposes to use for construction;
- g. Shop drawings, test results, and sample submittals;
- h. Survey layout and stakeout;
- i. All supplemental items specified in the Special Provisions.

The Work Plan shall be submitted to the Engineer prior to the Pre-Construction Conference by the date provided in the Special Provisions. The Engineer shall review the Work Plan and have the Contractor make any necessary revisions prior to acceptance of the plan. **No payment for mobilization will be made until the Work Plan has been accepted by the Engineer.**

GP-9 PROGRESS SCHEDULE

The Contractor shall develop a written Progress Schedule which provides for an orderly progression of the Work, submittals, tests, and deliveries in order to complete the Work within the specified Milestones and Contract Time. All of the items listed in the Work Plan shall be integrated into the Progress Schedule. The format of the schedule shall be composed using Microsoft Project®, or any other software deemed acceptable by the Engineer. It shall be updated weekly by the Contractor, at a minimum. The Progress Schedule shall also include, but not be limited to the following:

- a. All of the elements in the Work Plan, including updates;
- b. A work order issued from Louisiana One Call ordering all their subscribers in the project area to mark their utilities;
- c. A telephone log verifying that all property owners and utilities have been contacted. This log should list the time, date, and names of the personnel representing the property owners, utilities, and Contractor;

The following table defines the monthly anticipated adverse weather days that are expected to occur during the Contract Time and will constitute the baseline monthly weather time for evaluations. The schedule is based upon National Oceanic and Atmospheric Administration (NOAA) or similar data for the regional geographic area.

Monthly Anticipated Adverse Weather Calendar Days											
Jan.	Feb.	Mar.	Apr.	May	Jun.	Jul.	Aug.	Sep.	Oct.	Nov.	Dec.
5	5	4	4	4	5	7	7	5	3	3	4

The Progress schedule must reflect these anticipated adverse weather delays on all weather dependent activities. Adverse weather days must prevent Work for fifty percent (50%) or more of the work day and delay work critical to the timely completion of the project. The number of actual adverse weather days shall be calculated chronologically from the first to the last day of each month.

The Progress Schedule shall be submitted to the Engineer prior to the Pre-Construction Conference by the date provided in the Special Provisions. The Engineer shall perform a review and have the Contractor make any necessary revisions prior to acceptance of the schedule. Acceptance will not impose responsibility on the Owner or Engineer for the sequencing, scheduling, or progression of the Work. The Contractor is fully responsible for progression of the Work in order to maintain the compliance with the Progress Schedule.

GP-10 DAILY PROGRESS REPORTS

The Contractor shall record the following daily information on Daily Progress Reports:

- a. Date and signature of the author of the report;
- b. Dollar amount of all bid items that are fabricated, installed, backfilled, pumped, constructed, damaged, replaced, etc. The amount of material shall be expressed in the units stated in the bid;

- c. Field notes of all surveys;
- d. Notes on all inspections;
- e. Details of Health and Safety meetings;
- f. A brief description of any Change Orders, Field Orders, Claims, Clarifications, or Amendments;
- g. Condition of all navigation aides (I.E., warning signs, lighted marker buoys) and any repairs performed on them;
- h. Weather conditions (adverse weather day, wind speed and direction, temperature, wave height, precipitation, etc.);
- i. The amount of time lost to severe weather or personnel injury, etc;
- j. Notes regarding compliance with the Progress Schedule;
- k. Visitor log (Instructions for format will be furnished by the Field Engineer).

The daily progress reports shall be submitted to the Engineer at the Bi-Weekly Progress Meetings specified in GP-13 in both hard copy and digital format (Adobe Acrobat® Format, or approved equal). The typical form for Daily Progress Reports shall be developed by the Contractor and incorporated into the Work Plan.

GP-11 HURRICANE AND SEVERE STORM PLAN

The Contractor shall develop and maintain a written Hurricane and Severe Storm Plan. The Plan shall include, but not be limited to, the following:

- a. What type of actions will be taken before storm strikes at the Project Site. The plan should specify what weather conditions or wave heights will require shutdown of the Work and removal of equipment, personnel, etc.
- b. Notes from continuous monitoring of NOAA marine weather broadcasts and other local commercial weather forecasts.
- c. Equipment list with details on their ability to handle adverse weather and wave conditions.
- d. List of safe harbors or ports and the distance and travel time required to transfer equipment from the Project Site.
- e. Hard copies of any written approvals or operations schedules associated with the use of the safe harbors or ports.
- f. Method of securing equipment at the safe harbors or ports.

- g. List of tug boats and work boats and their respective length, horsepower, etc. which will adequately transfer the equipment to safe harbor or port under adverse weather conditions.
- h. Methods which will be used to secure equipment left onsite during adverse weather conditions.
- i. Evacuation or immediate reaction plans to be taken by personnel for sudden storm occurrences.
- j. Operations procedures which will be used to secure critical dredging equipment such as spuds, swing wires, anchor wires, or tugs during adverse weather conditions.
- k. Communications protocol with local law enforcement and fire and rescue agencies.

The Contractor shall incorporate the Hurricane and Severe Storm Plan into the Work Plan. The Owner and Engineer are not responsible for the adequacy of this plan.

GP-12 HEALTH AND SAFETY PLAN AND INSPECTIONS

The Contractor shall develop and maintain a written Health and Safety Plan which allows the Work to be performed in compliance with all applicable laws, ordinances, rules, and regulations of any government agency having jurisdiction over the safety of personnel or property. This includes maintaining compliance with the Code of Federal Regulations, Title 29, Occupational Safety and Health Administration (OSHA) and all applicable Health and Safety Provisions of the State of Louisiana.

The Contractor shall institute a daily inspection program to assure that the requirements of the Health and Safety Plan are being fulfilled. Inspections shall include the nature of deficiencies observed, corrective action taken or to be taken, location of inspection, date, and signature of the person responsible for its contents. The results of the inspections shall be recorded on Daily Progress Reports and kept at the Project Site during the Work.

The Contractor shall incorporate the Health and Safety Plan into the Work Plan. The Owner and Engineer are not responsible for the adequacy of this plan.

GP-13 PROGRESS MEETINGS AND REPORTS

The Engineer shall schedule meetings to review the progress of the Work, coordinate future efforts, discuss compliance with the Progress Schedule and resolve miscellaneous problems. The Engineer or Resident Project Representative, Contractor, and all Subcontractors actively working at the Project Site shall attend each meeting. Representatives of suppliers, manufacturers, and other Subcontractors may also attend at the discretion of the Contractor. The Contractor shall record the details of each meeting in a Progress Report. The format of this report shall be developed by the Contractor, approved by the Engineer, and included in the Work Plan. The progress meetings and reports shall be scheduled according to the Special Provisions.

GP-14 PRE-CONSTRUCTION CONFERENCE

A Pre-Construction Conference shall be held by the Contractor, Owner, Engineer, local stakeholders, and other appropriate personnel prior to starting construction on the date specified in the Special Provisions. This conference shall serve to establish a mutual understanding of the Work to be performed, the elements of the Progress Schedule and Work Plan, expectations for bi-weekly progress meetings, the Plans and Specifications, processing Applications for Payment, and any other items of concern. If any subcontractors are not present, another pre-construction conference will be required.

GP-15 CONTRACT INTENT

The Bid Documents are complementary; what is called for by one is as binding as if called for by all. Clarifications and interpretations or notifications of minor variations and deviations of the Contract Documents will be issued by Engineer as provided in these Specifications. Any labor, documentation, services, materials, or equipment that may reasonably be inferred from the Bid Documents or from prevailing custom or trade usage as being required to produce the intended result will be provided at no additional cost to the Owner.

GP-16 ENGINEER AND AUTHORITY OF ENGINEER

The Engineer will be the designated representative of the Owner, the initial interpreter of the Contract Documents and the judge over acceptability of all the Work. Claims, disputes, and other matters relating to the acceptability of the Work, performance by the Contractor or the interpretation of the requirements of the Contract Documents must be submitted to the Engineer in writing. Upon written request from the Contractor, the Engineer shall issue written clarifications or interpretations which are consistent with the overall intent of the Contract Documents. Such written clarifications and interpretations will be binding on the Owner and the Contractor. Either the Owner or the Contractor may make a Claim if a written clarification or interpretation justifies an adjustment in the Contract Price or Contract Times.

The Engineer has the authority to suspend the Work in whole or in part due to failure of the Contractor to correct conditions unsafe for workmen or the general public, carry out provisions of the Contract, perform conformance work, or to carry out orders. The Engineer shall submit a written order to the Contractor for work which must be suspended or resumed. Nothing in this provision shall be construed as establishing responsibility on the part of the Engineer for safety which is the responsibility of the Contractor.

The Engineer or Resident Project Representative shall keep a daily record of weather and flood conditions and may suspend the Work as deemed necessary due to periods of unsuitable weather, conditions considered unsuitable for execution of the Work, or for any other condition or reason deemed to be in the public interest.

GP-17 CONFORMITY WITH PLANS AND SPECIFICATIONS

All work and materials involved with the Work shall conform with the lines, grades, cross sections, dimensions, and other requirements shown on the Plans or indicated in these Specifications unless otherwise approved by the Engineer.

GP-18 CLARIFICATIONS AND AMENDMENTS TO CONTRACT DOCUMENTS

The Contract Documents may be clarified or amended by the Engineer to account for additions, deletions, and revisions to the Work after the Effective Date of the Contract. The clarifications and amendments shall be addressed by either a Change Order or a written clarification by the Engineer. The Contractor shall not proceed with the Work until the Change Order or clarification has been issued by the Engineer. The Contractor shall not be liable to the Owner or Engineer for failure to report any such discrepancy unless the Contractor had reasonable knowledge.

The Contractor may request a clarification or amendment for the following:

- a. Any conflict, error, ambiguity, or discrepancy within the Contract Documents; or
- b. Any conflict, error, ambiguity, or discrepancy between the Bid Documents and the provision of any Law or Regulation applicable to the performance of the Bid; or
- c. Any standard, specification, manual, or code (whether or not specifically incorporated by reference in the Bid Documents); or
- d. Instructions by a supplier.

The official form for a written clarification is provided in Appendix B. This form shall be filled out appropriately by the Contractor and submitted to the Engineer. The Engineer shall clarify the issue in writing on either the clarification form, Field Order or a Change Order and submit it to the Contractor.

GP-19 SUBCONTRACTS

The Contractor shall provide the names of all Subcontractors to the Engineer in writing before awarding any Subcontracts. The Contractor shall be responsible for the coordination of the trades and Subcontractors engaged in the Work. The Contractor is fully responsible to the Owner for the acts and omissions of all the Subcontractors. The Owner and Engineer will not settle any differences between the Contractor and Subcontractors or between Subcontractors. The Contractor shall have appropriate provisions in all Subcontracts to bind Subcontractors to the Contractor by the terms of the General Provisions and other Contract Documents, as applicable to the Work of Subcontractors. The provisions should provide the Contractor the same power regarding termination of Subcontracts that the Owner may exercise over the Contractor under any provisions of the Contract Documents.

GP-20 WORKERS, METHODS, AND EQUIPMENT

The Contractor shall provide competent, qualified, and trained personnel to perform the Work. The Contractor shall not employ any person found objectionable by the Engineer. Any person employed by the Contractor or any Subcontractor who, in the opinion of the Engineer, does not perform the Work in a proper, skillful, and orderly manner shall be immediately removed upon receiving a written order by the Engineer. The Engineer may also suspend the Work until the Contractor removes the employee or provides a suitable replacement. Such an employee shall not be re-employed in any portion of the Work without written approval from the Engineer.

The on-site superintendent for the Contractor shall be competent, English-speaking, and qualified to receive orders, supervise, and coordinate all Work for the Contractor and any Subcontractors. The qualifications of the superintendent must be established and approved by the Engineer prior to commencement of the Work. The superintendent shall be furnished by the Contractor regardless of how much Work may be sublet. In the performance of the Work under this Contract, the Contractor shall conduct operations to avoid interference with any other Contractors.

All equipment, products, and material incorporated into the Work shall be as specified, or if not specified, shall be new, of good quality, and protected, assembled, used, connected, applied, cleaned, and conditioned in accordance with the manufacturer's instructions, except as otherwise may be provided in the Bid Documents. All equipment shall be of sufficient size and mechanical condition to meet the requirements of the Work and produce a satisfactory quality of work. Equipment shall not damage adjacent property throughout the performance of the Work. The Plant and Equipment Schedule should be completed by the Contractor.

The Contractor shall be solely responsible for the means, methods, techniques, sequences, and procedures used to complete the Work in conformance with the Contract Documents.

The Contractor shall obtain permission from the Engineer if a method or type of equipment other than specified in the Contract is desired. The request shall be in writing and shall include a full description of the methods, equipment proposed, and reasons for the modification. A proposed item of material or equipment may be considered by the Engineer to be functionally equal to an item specified in the Contract if:

- a. It is at least equal in quality, durability, appearance, strength, and design characteristics;
- b. There is no increase in any cost including capital, installation, or operating to the Owner;
- c. The proposed item will conform substantially, even with deviations, to the detailed requirements of the item named in the Bid Documents.

If, after trial use of the substituted methods or equipment, the Engineer determines that the Work produced does not meet Contract requirements, the Contractor shall discontinue use of the substituted methods or equipment and shall complete the Work with the specified methods and equipment. The Contractor shall remove the deficient Work and replace it with Work of specified quality or take other corrective action as directed. No change will be made in basis of payment for construction items involved or in Contract Time as a result of authorizing a change in methods or equipment.

GP-21 ACCIDENT PREVENTION, INVESTIGATIONS, AND REPORTING

The Contractor shall be responsible to develop and maintain all safeguards and safety precautions necessary to prevent damage, injury, or loss throughout the performance of the Work. All accidents at the Project Site shall be investigated by the immediate supervisor of employee(s) involved and reported to the Engineer or Resident Project Representative within one (1) working day. A complete and accurate written report of the accident including estimated lost time days shall be submitted to the Engineer within four (4) calendar days. A

follow-up report shall be submitted to the Engineer if the estimated lost time days differ from the actual lost time days.

GP-22 PRESERVATION AND RESTORATION OF PROPERTY, MONUMENTS, ETC.

The Contractor shall comply with all applicable laws, ordinances, rules, and regulations of any government agency having jurisdiction over the preservation and protection of public and private property. The Contractor shall install and maintain suitable safeguards and safety precautions during the Work as necessary to prevent damage, injury, or loss to property. This responsibility shall remain with the Contractor until the Work has been completed and accepted. Any damage, injury, or loss to property which is caused by the Contractor or Subcontractors shall be repaired or replaced at the expense of the Contractor.

The Contractor shall protect all land monuments, State and United States bench marks, geodetic and geological survey monuments, and property markers from disturbance or damage until an authorized agent has witnessed or otherwise referenced their location. The Contractor shall also provide protection for all public and private property including trees, utilities, pipes, conduits, structures, etc. These items shall not be removed unless directed by the Engineer.

The Contractor shall be responsible to completely repair all damages to public or private property due to any act, omission, neglect, or misconduct in the execution of the Work unless it is due to unforeseeable causes beyond the control of and without the fault or negligence of the Contractor, including but not restricted to acts of God, public enemies, or governmental authorities. The damage must be repaired at the expense of the Contractor before final acceptance of the Work can be granted by the Engineer. If the Contractor fails to repair the damage within forty-eight (48) hours, the Owner may independently proceed with the repairs at the expense of the Contractor by deducting the cost from the Contract. If the Contractor cannot provide for the cost of repairs, the Surety of the Contractor shall be held until all damages, suits, or claims have been settled.

GP-23 PROTECTION OF THE WORK, MATERIALS, AND EQUIPMENT

It shall be the responsibility of the Contractor to protect the Work, materials, and equipment from damages or delays due to inflows, tidal rise, and storm water runoff which may occur at the Project Site. The Owner shall not be held liable or responsible for these types of delays or damages.

GP-24 LAND RIGHTS

The Owner has been granted all of the temporary easements, servitudes, and right-of-way agreements from public and private landowners in order to perform the Work. A land rights memorandum which lists all known responsible contacts and required stipulations is provided in Appendix F. The Contractor is responsible to notify all of the contacts and abide by stipulations listed in that memorandum.

GP-25 UTILITIES

The Owner has been granted all of the temporary easements, servitudes, and right-of-way agreements from known public and private utilities in order to perform the Work. The

utilities include, but are not limited to telephone, telegraph, power poles or lines, water or fire hydrants, water or gas mains and pipelines, sewers, conduits, and other accessories or appurtenances of a similar nature which are fixed or controlled by a city, public utility company or corporation.

The Contractor shall conduct the Work in such a manner as to cooperate and minimize inconveniences with utilities. Prior to commencement of the Work, the Contractor is responsible to notify all of the utilities and abide by stipulations required by the utility company(s). The Contractor shall also call Louisiana One Call at 1-800-272-3020 a minimum of 5 working days prior to construction to locate existing utilities at the Project Site.

Any damage to utilities that is caused by the Contractor within the Project Site shall be repaired at the expense of the Contractor. The Owner will not be responsible for any delay or damage incurred by the Contractor due to working around or joining the Work to utilities left in place or for making adjustments.

Any unidentified pipes or structures which may be discovered within the limits of the Project Site shall not be disturbed and shall be reported to the Engineer as soon as possible. Construction or excavation shall not be performed around unidentified utilities without prior approval from the Engineer.

GP-26 PERMITS

Federal and State permits that are required to perform the Work, such as the Department of the Army Permit, Coastal Use Permit, LDEQ Clean Water Permit, LDWF Fill Material License, and LADOTD highway crossing permit have been secured by the Owner. Permit conditions affecting the construction processes have been included in these Specifications. Copies of these permits will be provided to the Contractor at the pre-construction conference. These permits will not relieve the responsibility of the Contractor from obtaining any additional permits which may be needed to complete the Work. Copies of any special permits that are obtained by the Contractor must be submitted to the Owner. The Contractor shall conform to the requirements therein and display copies of the permits in a public setting at the Project Site at all times.

GP-27 PROJECT SITE CLEAN-UP

The Contractor shall keep the Project Site free from accumulations of waste material or trash at all times. All trash and waste materials shall be removed by the Contractor and disposed off-site in an approved waste disposal facility. In addition, all equipment, tools, and non-conforming work shall also be removed prior to the Work being accepted. No materials shall be placed outside of the Project Site.

GP-28 OWNER INSPECTION

The Owner, Resident Project Representative, and Federal Sponsor shall have the right to perform reasonable inspections and testing of the Work at the Project Site. Access shall be granted to the entire Project Site including all materials intended for use in the Work. The Contractor shall allow reasonable time for these inspections and tests to be performed. The inspections shall not relieve the Contractor from any obligation in accordance with the requirements of the Contract.

The Owner shall notify the Contractor prior to all tests, inspections, and approvals of the Work which are to be conducted at the Project Site. The Owner shall also provide the Contractor with the written results of all inspections and tests. Inspections, tests, or Payments made by the Owner shall not constitute acceptance of non-conforming Work of prejudice the Owner's rights under the Contract.

GP-29 DUTIES OF RESIDENT PROJECT REPRESENTATIVE

A Resident Project Representative shall be assigned by the Engineer to the Project Site to observe the Contractor and monitor the progress and manner in which the Work is being performed. The Resident Project Representative will also report to the Engineer and Contractor whenever materials or Work fail to comply with the Contract. The Resident Project Representative is authorized to reject any materials or suspend work which does not comply with the Contract until the issue is resolved by the Engineer.

However, the Resident Project Representative is not authorized to revoke, alter, enlarge, relax, or release any requirements of the Contract, or to approve or accept any portion of the Work, or to issue instructions contrary to the Plans and Specifications. The Resident Project Representative shall not manage or perform duties for the Contractor.

GP-30 CONSTRUCTION STAKES, LINES, AND GRADES

The Engineer shall direct the Contractor to all control points necessary for setting stakes and establishing lines and grades as shown on the Plans. The Contractor shall be responsible for laying out all of the Work. All layouts shall be witnessed and verified by the Engineer or Resident Project Representative prior to beginning the Work. The Contractor shall be responsible for proper execution of the Work according to the layouts after receiving verification from the Engineer.

The Contractor shall be responsible for furnishing and maintaining stakes such that the Work can be verified for acceptance. The Engineer may suspend the Work at any time if it cannot be adequately verified due to the number, quality, or condition of the stakes.

GP-31 CONTRACTOR'S RESPONSIBILITY FOR WORK

The Contractor shall execute all items covered by the Contract, and shall furnish, unless otherwise definitely provided in the Contract, all materials, implements, machinery, equipment, tools, supplies, transportation, and labor necessary to complete the Work. The Contractor shall pay constant attention to the progress of the Work and shall cooperate with the Engineer in every way possible. The Contractor shall maintain a complete copy of the Contract at all times, including the Plans, Specifications, and any authorized modifications.

GP-32 ENVIRONMENTAL PROTECTION

The Contractor shall comply with and abide by all federal, state, and local laws and regulations controlling pollution of the environment, including air, water, and noise. The Contractor shall take precautions to prevent pollution of waters and wetlands with fuels, oils, bituminous materials, chemicals, sewage, or other harmful materials and contaminants, and to prevent pollution of the atmosphere from particulate and gaseous matter, in accordance with

all terms and conditions of federal, state, and local air and water pollution control laws and programs and their rules and regulations, including the federal Clean Air Act and the federal Clean Water Act.

The Contractor shall adhere to the provisions which require compliance with all standards, orders, or requirements contained under Section 306 of the Clean Air Act and Section 508 of the Clean Water Act, which prohibit the use under non-exempt Federal contracts, grants, or loans, of facilities included on the Environmental Protection Agency (EPA) list of Violating Facilities.

Construction operations in rivers, streams, lakes, tidal or coastal waters, reservoirs, canals, wetlands, and any other impoundments shall be restricted to areas where it is necessary to accomplish the Work and performed in accordance with any applicable federal, state, and local laws, regulations, permit requirements, and guidelines, and the Contractor shall conduct the Work in a manner that will not cause damaging concentrations of silt or pollution to water.

Contractor shall maintain and operate equipment to minimize noise, dust, and vibration near noise, dust and vibration-sensitive areas such as churches, hospitals, schools, and residential areas, and assure that any activities conducted near such areas are not unduly disruptive. Contractor shall maintain all equipment with properly functioning mufflers.

The Contractor shall be responsible for determining and utilizing any erosion and pollution control features or methods that may be necessary to comply with all federal, state, and local laws and regulations.

GP-33 SANITARY PROVISION

The Contractor shall provide and maintain sanitary accommodations for use by all employees and Subcontractors. Facilities shall comply with the requirements of the Louisiana State Board of Health and Hospitals and other authorities having jurisdiction. Committing public nuisance on the Project Site is prohibited.

GP-34 PAYMENT OF TAXES

The Contractor shall be responsible for all taxes and duties that maybe levied under existing State, Federal, and local laws during the completion of the Work. The Owner will presume that the amount of such taxes is included in the unit prices bid by the Contractor and will not provide additional reimbursement.

GP-35 RADIO AND TELEPHONES

The Contractor shall furnish and maintain radio and telephone equipment throughout the Contract Time which will allow communication between the Contractor and the Engineer or Resident Project Representative.

GP-36 NAVIGATION

All marine vessels shall comply with the following Federal Laws and Regulations:

- a. The International Navigational Rules Act of 1977 (Public Law 95-75, 91 Stat. 308, or 33 U.S.C. 1601-1608); and
- b. The Inland Navigation Rules Act of 1980 (Public Law 96-591, 94 Stat. 3415, 33 U.S.C. 2001-2038).

These rules can be found on the Internet at:

<http://www.navcen.uscg.gov/mwv/navrules/navrules.htm> . All marine vessels shall display the lights and day shapes required by Part C- Lights and Shapes of the Inland Navigation Rules. The location, type, color, and size of the lights and day shape shall be in accordance with Annex I - Positioning and Technical Details of Lights and Shapes. Any vessel engaged in dredging is considered a "Vessel restricted in her ability to maneuver" and shall display all the lights and shapes required in Rule 27, "Vessel Not Under Control."

GP-37 OBSTRUCTION TO NAVIGATION

The Contractor shall minimize all obstructions to navigation in compliance with pertinent U. S. Coast Guard regulations while conducting the Work. The Contractor shall promptly move any floating equipment or marine vessels which obstruct safe passage of other marine vessels. Upon completion of the Work, the Contractor shall remove all marine vessels and other floating equipment such as temporary ranges, buoys, piles, and other marks or objects that are not permanent features of the Work.

GP-38 MARINE VESSELS AND MARINE ACTIVITIES

All marine vessels operated by the Contractor shall possess a valid United States Coast Guard (USCG) inspection certificate and current American Bureau of Shipping (ABS) Classification. All officers and crew shall possess valid USCG licenses as required by USCG regulations. These certificates, classifications, and licenses shall be posted in a public area on board each vessel.

All marine vessels not subject to USCG certification or ABS Classification shall be inspected annually by a marine surveyor accredited by the National Association of Marine Surveyors (NAMS) or the Society of Accredited Marine Surveyors (SAMS). All inspections shall be documented using an appropriate report format. At a minimum, the inspections shall evaluate the structural integrity of the vessel and comply with the National Fire Protection Association Code No. 302- Pleasure and Commercial Motor Craft. The most recent inspection report shall be posted in a public area on board each vessel.

GP-39 RECORD KEEPING

The Contractor shall maintain orderly records of the Progress Schedule, Daily Progress Reports, Progress Meetings, correspondence, submittals, reproductions of original Contract Documents, Change Orders, Field Orders, certificates, additional drawings issued subsequent to the executed Contract, clarifications and interpretations of the Contract Documents by the Engineer, and other related documents at the Project Site until all of the Work is accepted by the Engineer.

GP-40 CERTIFICATES OF COMPLIANCE

Any certificates required for demonstrating proof of compliance of materials with specification requirements shall be executed in three (3) copies. Each certificate shall be certified by an authorized agent of the supplying company and shall contain the name and address of the Contractor, the project name and location, and the quantity and date of shipment. Copies of laboratory test reports submitted with certificates shall contain the name and address of the testing laboratory and the testing date. The Contractor shall also certify that all materials and test reports conform to the requirements of the Contract. Certification shall not be construed as relieving the Contractor from furnishing satisfactory material if the material is tested and determined to be in nonconformance.

GP-41 SUBMITTALS

The Contractor shall review all Submittals for compliance with the requirements of the Contract prior to delivery to the Engineer. Each Submittal shall contain a signed statement by the Contractor that it complies with the Contract requirements with any exceptions explicitly listed. The Contractor shall comply with these requirements for Submittals from Subcontractors, manufacturers, and suppliers.

All Submittals shall include sufficient data to demonstrate that the requirements of the Contract are met or exceeded. All submittals shall be legible and marked with the project title and clearly identify the item submitted. Each submittal package shall include an itemized list of the items submitted.

All Submittals will be reviewed within fourteen (14) days after being received by the Engineer. The Contractor shall allow the Engineer sufficient time for review, corrections, and resubmission of all Submittals prior to beginning the associated Work. The Contract Time shall not be extended based on incorrect or incomplete Submittals.

GP-42 CLAIMS FOR EXTRA COST

The Contractor is expected to complete the Work according to the Contract Price specified in the Bid Documents. If the Contractor deems additional compensation is due for work, materials, delays or other additional costs/or expenses not covered in the Contract or not ordered as extra work, the Contractor shall give the Engineer written notice thereof within fourteen (14) calendar days after the receipt of such instructions and, in any event, before commencing the procedure. The Contractor shall justify the claim for extra cost by providing supporting data and calculations. The Engineer shall determine whether the Contractor is entitled to be compensated for such extra cost and shall make any required adjustments of the Contract in accordance with GP-43. If no written claim is made within this fourteen (14)

calendar-day period, the Contractor will be deemed to have waived any claim for extra cost for such work.

Claim for damages or delays of the Work shall not be made by the Contractor for a relocation of the construction operation or portions thereof to other locations within the geographical scope of the project, when in the opinion of the Engineer, such relocation is necessary for the most effective prosecution of the Work and may be accomplished without undue hardship.

GP-43 ALTERATION OF THE CONTRACT AND COMPENSATION

Using Change Orders, Field Orders, or Written Amendments, the Owner may order extra work or make changes by altering the details of construction, add to or deduct from the Work. The requirements and stipulations of these documents shall be binding on the Owner and Contractor throughout the remainder of the Contract. Any claim for an extension of Contract Time caused thereby shall be adjusted at the time of ordering such change.

The value of any such extra work or change shall be determined in one or more of the following ways and in the following priority:

- a. By application of the unit prices in the Contract to the quantities of the items involved or subsequently agreed upon; or
- b. By mutual acceptance between the Owner and Contractor of a lump sum.

If none of the above methods is agreed upon, the Contractor, provided he is so ordered by the Owner in writing, shall proceed with the Work on a "force account" basis. In such a case, the Contractor shall keep and preserve in such form as the Engineer may direct, a correct itemized account of the direct cost of labor, materials, equipment, together with vouchers bearing written certification by the Contractor. In any case, the Engineer shall certify to the amount, including an allowance of fifteen percent (15%) for jobsite and home office overhead indirect expenses and profit due to the Contractor. Where such change involves a subcontractor, an allowance of fifteen percent (15%) for overhead and profit shall be due the subcontractor and an allowance of ten percent (10%) shall be due the Contractor. Pending final determination of value, payments on account of changes shall be made on the Engineer's estimate and as approved in an executed Change Order.

If the Contractor is prevented from completing the Work according to the Contract Price due to the Owner, the Contractor may be entitled to any reasonable and necessary addition of cost as determined by the Engineer. Neither the Owner nor the Contractor shall be entitled to any damages arising from events or occurrences which are beyond their control, including but not limited to fires, floods, epidemics, abnormal weather conditions, acts of God, acts of war, and other like matters. The provisions of this section exclude recovery for damages caused by the Contractor and compensation for additional professional services by either party.

GP-44 EXTENSION OF CONTRACT TIME

The Contractor is expected to complete the Work within the Contract Time specified in the Bid Documents. A legitimate increase of the Contract time may be requested by the Contractor throughout the course of the Work. This Claim must be submitted to the Engineer in writing within fourteen (14) days of the event which caused the time delay to the

Contractor. If an extension of Contract Time involves an increase in Contract Price, both claims shall be submitted together. The Contractor shall justify the increase of the Contract Time in the Claim using supporting data and calculations. The Engineer may deny the claim if there is insufficient information to make a determination. If the Claim is approved, the Engineer shall issue a Change Order within thirty (30) days of the Claim. The Contract Time shall be increased on a basis that is commensurate with the amount of additional or remaining Work. For example, the Contract Time can be increased where the number of actual adverse weather days exceeds the number of days estimated in the Contract.

GP-45 OWNER'S RIGHT TO TERMINATE CONTRACT FOR CAUSE OR CONVENIENCE

45.1 TERMINATION FOR CAUSE

The Owner shall submit a written notice to the Contractor and Surety which justifies placement of the Contractor in default if:

- a. The Work is not begun within the time specified in the Notice to Proceed; or
- b. The Work is performed with insufficient workmen, equipment, or materials to assure prompt completion; or
- c. The Contractor performs unsuitable, neglected or rejected work, refuses to remove materials; or
- d. The Work is discontinued; or
- e. The Work is not completed within the Contract Time or time extension; or
- f. Work is not resumed within a reasonable time after receiving a notice to continue; or
- g. The Contractor becomes insolvent or is declared bankrupt, or commits any act of bankruptcy or insolvency; or
- h. The Contractor allows any final judgment to stand unsatisfied for a period of ten (10) days; or
- i. The Contractor makes an assignment for the benefit of creditors; or
- j. The Work is not performed in an acceptable manner.

If the Contractor or Surety does not remedy all conditions cited in the written notice within ten (10) days after receiving such a notice, the Contractor will be in default and the Owner shall remove the Contractor from the Work. If the Contractor is placed into default, the Owner may obtain the necessary labor, materials, and equipment or enter into a new Contract in order to complete the Work. All costs incurred by the Owner for completing the Work under the new Contract will be deducted from the payment due the Contractor. If the expense exceeds the sum payable under the Contract, the Contractor and Surety shall be liable to pay the Owner the difference.

45.2 TERMINATION FOR CONVENIENCE

Owner may, at any time, terminate this Contract or any portion thereof, for Owner's convenience, upon providing written notice to the Contractor. In such case, Contractor shall be paid for all work completed through the date notice was provided (less payments already received) and reasonable demobilization and restocking charges incurred and reasonable overhead and profit based upon industry standards on the work performed. In no event shall the Contractor be entitled to payment of overhead and profit on work not performed. In the event it is determined that the Contractor was wrongfully terminated for cause, pursuant to Section GP 45.1 above, such termination shall be automatically converted to a termination for convenience under and payment made as provided under this Section.

GP-46 TEMPORARY SUSPENSION OF WORK

The Engineer shall have the authority to temporarily suspend the Work in whole or in part. A Field Order shall be issued to the Contractor for any of the Work that is suspended for periods exceeding one (1) calendar day. The Field Order shall include the specific reasons and details for the suspension. The Contract Time shall not be extended if the Work is suspended due to failure by the Contractor to comply with a Field Order or with the Plans and Specifications. If the Work is suspended in the interest of the Owner, the Contractor shall make due allowances for the lost time.

GP-47 NON-CONFORMING AND UNAUTHORIZED WORK

Work not conforming to the Plans, Specifications, Field Orders, or Change Orders shall not be accepted for payment. Unacceptable or unauthorized work shall be removed and replaced in an acceptable manner at the expense of the Contractor in order to obtain final acceptance of the Work.

If the Contractor should neglect to prosecute the work properly or fail to perform any provision of this Contract, the Owner after seven (7) calendar days written notice to the Contractor, may correct such deficiencies itself or by use of other contractors without prejudice to any other remedy it may have, and may deduct the cost thereof from the payment then or thereafter due to the Contractor.

GP-48 CONTRACTOR'S RIGHT TO TERMINATE CONTRACT

The Contractor may terminate the Contract or Work and recover payment from the Owner for labor and materials if the Work is stopped through no act or fault of the Contractor for more than three (3) months. For example, such an occurrence could be caused by a court order or other public authority. In any case, the Contractor shall submit a written notice to the Engineer at the beginning of the occurrence, and a written Claim to the Owner at the end of the occurrence.

GP-49 BREACH OF CONTRACT

The Owner shall submit a written Claim to the Contractor regarding any breach of the Contract. The Contractor must provide a written response to the Owner regarding the breach

of Contract within ten (10) days after the Claim. This response must provide either an admission to the Claim or a detailed denial based on relevant data and calculations. The failure of the Contractor to provide a proper response within ten (10) days shall result in justification of the Claim by default.

GP-50 NO WAIVER OF LEGAL RIGHTS

The Owner shall not be prevented from recovering costs from the Contractor, Surety, or both due to failure of the Contractor to fulfill all of the obligations under the Contract. If a waiver is provided to the Contractor for a breach of Contract by the Owner, it shall not apply to any other breach of Contract. Final acceptance of the Work shall not prevent the Owner from correcting any measurement, estimate, or certificate. The Contractor shall be liable to the Owner without prejudice to the terms of the Contract or any warranty for latent defects, fraud, or gross negligence.

GP-51 LIABILITY FOR DAMAGES AND INJURIES

To the fullest extent permitted by Laws and Regulations, the Contractor shall indemnify and hold harmless the Owner, Engineer, and their officers, employees, representatives, and/or agents from all suits, actions, claims, costs, losses, demands, and judgments (including but not limited to fees and charges of engineers, architects, attorneys, and other professionals and all court or arbitration or other dispute resolution costs) brought because of injuries or damage sustained by a person or property due to the operations of Contractor; due to negligence in safeguarding the Work, or use of unacceptable materials in constructing the Work; or any negligent act, omission, or misconduct of the Contractor; or claims or amounts recovered under the Workmen's Compensation Act or other law, ordinance, order, or decree; any money due the Contractor as considered necessary by the Owner for such purpose may be retained for use of the State or in case no money is due, the performance and payment bond may be held until such suits, actions, claims for injuries or damages have been settled and suitable evidence to that effect furnished to the Owner; except that money due the Contractor will not be withheld when the Contractor produces satisfactory evidence that adequate Workman's Compensation, Public Liability, and Property Damage Insurance are in effect.

The indemnification obligations of the Contractor shall not extend to the liability of the Owner, Engineer, and their affiliates arising out of the preparation or approval of the Plans, Specifications, maps, opinions, reports, surveys, or Change Orders, or for providing directions or instructions which are the primary cause of the injury or damage.

Should the Owner or Contractor suffer from any injury or damage due to an error, omission, or act of the other party or their legally liable affiliates, a written Claim shall be submitted to the other party within ten (10) days. The Claim shall provide all details regarding the injury or damage, the results of any investigations, and the action to be taken to prevent any recurrence.

GP-52 LIABILITY FOR LOSSES BY ACTS OF THE GOVERNMENT

The Owner shall not be liable for any loss or damage suffered by the Contractor arising out of a cessation of Work under this Contract due to any act or order of any local, state, or federal government agency. If this cessation occurs, the Contractor may request an extension of the Contract Time according to the provisions in GP-44.

GP-53 SUBSTANTIAL COMPLETION

Upon notice from the Contractor that it believes the project has reached substantial completion, and before final acceptance, the Engineer will make an inspection of the Work. "Substantial Completion" is defined as the date on which the Work is complete in accordance with the Contract Documents in order that the Owner can occupy and use the project for its intended use. The date of Substantial Completion shall be specified in the Notice of Acceptance.

If the Owner or its representative determines the Project is substantially complete, the Owner shall issue a Notice of Acceptance identifying the date the Project reached Substantial Completion and attach a punch list identifying the remaining items that must be completed before final payment. The Owner will then file an official Notice of Acceptance with the Clerk of Court in the Parish where the work is performed and will forward one copy of the recorded acceptance to the Contractor and Engineer.

If the inspection discloses any work as being unsatisfactory or incomplete and such work generates a formal punch list, the Engineer will give the Contractor instructions for correction of same, and the Contractor shall immediately comply with such instructions. Upon satisfactory completion of the corrections, when a "Punch List" is generated, the Engineer shall prepare a "Recommendation of Acceptance" incorporating the punch list and submit to the Owner. Upon approval of the Recommendation of Acceptance, the Owner may issue a Notice of Acceptance of the Contract which shall establish the date of Substantial Completion.

Any punch list generated by the Engineer shall be accompanied by a cost estimate to correct the particular items of work the Engineer has developed. The cost estimate shall be developed based on mobilization, labor, material, and equipment costs of correcting each punch list item and shall be retained from monies owed to the Contractor, above and beyond the standard retainage. The Engineer shall retain his working papers used to determine the punch list items cost estimates should the matter be disputed later. The Owner shall not withhold from payment more than the value of the punch list. Punch list items completed shall be paid upon the expiration of the forty-five (45) day lien period. After that payment, none of the remaining funds shall be due the Contractor until all punch list items are completed and are accepted by the Engineer.

If the dollar value of the punch list exceeds the amount of funds, less retainage amount, in the remaining balance of the Contract, the Project shall not be accepted as Substantially Complete. If the funds remaining are less than required to complete the punch list work, the Contractor shall pay the difference. The provisions listed above shall not be subject to waiver.

Warranties required by the Contract Documents shall commence on the date of Substantial

Completion of the Work/project as provided in the Notice of Acceptance, unless otherwise agreed to in writing by the Owner and Contractor. In the instance where the Owner has accepted the Work/project as substantially complete and issued a Notice of Acceptance, and the Contractor must remain on the premises to complete the "Punch List" or for whatever reason, the Contractor shall maintain Commercial General Liability insurance, Auto Liability insurance and Worker's Compensation insurance as set forth herein until the expiration of the forty-five (45) day lien period or upon the completion of the work/project, whichever is later. Builder's Risk insurance, if applicable, may be cancelled only with the written permission of the Owner or the Owner's representative at Substantial Completion.

If the punch list is not completed within forty-five (45) days, through no fault of Owner or Engineer, the Owner may, but is not required, to place the Contractor in default. Thereafter, the Owner shall notify the Surety. If the Surety has not completed the punch list within forty-five days of receipt of notification, the Owner may, but is not required to, complete the remaining punch list items. Any costs incurred shall be paid for first out of any remaining Contract funds. If the costs incurred exceed the remaining Contract funds, the Contractor and its Surety shall be liable for such costs.

Upon completion of the punch list, Contractor shall request Final Inspection.

GP-54 FINAL INSPECTION AND ACCEPTANCE

Whenever the work provided for, or contemplated by the contract, have been satisfactorily completed, all punch list items completed and the final cleaning up is performed, the Engineer shall be notified in writing that said work is completed and ready for final inspection. The Engineer shall, unless otherwise provided, make the final inspection within a reasonable length of time after the receipt of such notification.

If all construction provided for in the contract is found completed to the Engineer's satisfaction, that inspection shall constitute the final inspection and the Engineer will make recommendation to the Owner for final acceptance and notify the Contractor in writing of this recommendation of acceptance.

GP-55 AS-BUILT DRAWINGS

The Contractor shall submit all originals and copies of the As-Built Drawings to the Engineer for review and acceptance in accordance with the Special Provisions. The As-Built Drawings shall provide complete data for quantities, dimensions, specified performance and design criteria, and similar items which clearly represent the services, materials, and equipment the Contractor has provided. All revision sheets shall be clearly stamped with the words "As-Built".

GP-56 COMPLETION OF CONTRACT

Notwithstanding any other provision of this Contract and all applicable and necessary time delays under Louisiana law, completion of the Contract requires all of the Work to be complete, inspected by the Engineer, accepted by the Owner as recommended by the Engineer, and after final payment is made. After the Contract is complete, the Contractor will then be released from further obligation except as set forth in the Contract Bond and Contractor's Guarantee.

GP-57 CONTRACTOR'S GUARANTEE

The Contractor is obligated to provide a written guarantee to the Owner that all of the Work conforms to the Contract Documents. The Work shall be guaranteed to survive for a minimum period of 1 year after final acceptance, unless otherwise specified in the Technical Specifications.

- a. The guarantee shall include:
 - 57.a.1 A written warranty by the manufacturer for each piece of installed project equipment or apparatus furnished under the Contract.
 - 57.a.2 Any necessary repair or replacement of the warranted equipment during the guarantee period at no cost to the Owner.
 - 57.a.3 Satisfactory operation of installed equipment including, but not limited to, any mechanical and electrical systems furnished and constructed under the Contract during the guarantee period. The Contractor shall repair all equipment which fails due to defective materials or faulty workmanship during the guarantee period. The Contractor shall also be liable for all other ancillary expenses incurred by the Owner due to the failure.
- b. The guarantee shall exclude defects or damage caused by:
 - 57.b.1 Abuse or improper modification, maintenance, or operation by anyone other than the Contractor; or
 - 57.b.2 Wear and tear under normal usage.
- c. This obligation by the Contractor shall be absolute. The following actions will not constitute acceptance of non-conformance Work or release the Contractor from obligation to furnish the Work in accordance with the Contract Documents:
 - 57.c.1 Observations by the Owner or Engineer; or
 - 57.c.2 Recommendations by the Engineer or payment by the Owner; or
 - 57.c.3 Use of the Work by the Owner; or
 - 57.c.4 Issuance of a notice of acceptance by the Owner pursuant to the provisions of GP-53, or failure to do so; or

57.c.5 Any inspection, test, or approval by others; or

57.c.6 Any correction to non-conforming work by the Owner.

GP-58 DISPUTE RESOLUTION

The parties shall use their best efforts to resolve all disputes in an amicable fashion. Prior to filing suit by either party with respect to any claims, or disputes arising between the parties, the disputes shall be submitted first to non-binding mediation. The mediation shall be conducted in accordance with the Construction Industry Mediation Rules of the American Arbitration Association. If the parties cannot agree to a private mediator, then the mediator shall be selected by the American Arbitration Association, upon the filing of a demand for mediation.

If the dispute is not resolved by mediation within 60 days from the request for mediation, then either party may institute legal proceedings. Any litigation involving the Owner and arising under or related to the Contract or the bidding or award thereof shall be instituted exclusively in the 19th Judicial District Court in and for the Parish of East Baton Rouge, State of Louisiana.

GP-59 PAYMENT

The Owner hereby agrees to pay to the Contractor as full compensation for all work performed under the contract, and/or supplemental agreements thereto, the monetary value of the actual quantities in the completed work according to the schedule of unit prices and/or lump sum prices set forth in attached bid proposal and/or duly authorized supplements thereto, and made a part of the Contract.

Partial payments under the Contract shall be made at the request of the Contractor not more than once each month, based upon partial estimates agreed to by the Contractor and Engineer and shall be furnished to the Engineer and approved by the Engineer prior to transmittal to the Owner for approval and payment.

The partial estimates will be approximately stated, and all partial estimates and payments shall be subject to corrections in the estimate rendered following the discovery of any error in any previous estimates.

The payment of the partial estimate shall be taken as verification that the work has been performed and that its quality is satisfactory, however it will in no way serve as a release to the Contractor for the responsibility of any portions thereof. The work and any particulars relating thereto shall be subject to revision and adjustment by the Engineer and/or the Owner at any time prior to final payment, regardless of any previous action taken.

There shall be reserved from the payments provided for the Contract ten percent (10%) for contracts less than \$500,000 or five percent (5%) for contracts of \$500,000 or more, of the estimates submitted, said sum to constitute a trust fund for the protection of and payment to any person or persons, mechanic, subcontractor or materialmen who shall perform any labor upon such contract, or the doing of said work, and all persons who shall supply such person

or persons or subcontractors with provisions and supplies for the carrying on of such work, and shall be withheld for a minimum of forty-five (45) calendar days after final acceptance of the completed contract.

After the expiration of the forty-five (45) calendar day period, the reserve in excess of a sum sufficient to discharge the claims of materialmen and laborers who have filed their claims, together with a sum sufficient to defray the cost of such action and to pay attorneys' fees, shall be paid to the Contractor.

The Contractor shall be responsible for obtaining and furnishing a clear lien and privilege certificate to the Owner at the expiration of the retainage period, and prior to payment of any reserve withheld.

GP-60 PAYMENTS WITHHELD

In addition to the percentage provided for in Section GP-58 of these General Provisions and in accordance with any other provision of this Contract, the Owner may withhold such amounts from any payment as may be necessary to protect himself from loss on account of:

- a) Defective work not remedied;
- b) Claims filed or reasonable evidence indicating probable filing of claims;
- c) Failure of the Contractor to make payments properly to subcontractors or for material or labor;
- d) Reasonable evidence that the Work will not be completed within the Contract time and that the unpaid balance would not be adequate to cover damages for the anticipated delay;
- e) A reasonable doubt that the contract can be completed within the time period remaining under the contract;
- f) Damage to another contractor;
- g) Failure to submit required reports; or
- h) Modifications of the contract which necessitate the execution of change orders prior to payment of funds.

Furthermore, nothing contained in this Section shall be deemed to limit the right of the Owner to withhold liquidated damages, as stated in the Instructions to Bidders and as permitted under Section SP-7 of the Special Provisions, from any amounts which may be due and owing the Contractor for work performed under the contract.

GP-61 LIENS

Neither the final payment nor any part of the retained percentage shall come due until the Contractor shall deliver to the Owner a complete release of all liens arising out of this contract, or receipts in full in lieu thereof, and, if required by the Owner, an affidavit that so far as he has knowledge or information, the releases and receipts include all labor and

material for which a lien could be filed; but if any subcontractor refuses to furnish a release or receipt in full, the Contractor may furnish a bond satisfactory to the Owner to indemnify the Owner against any lien, construction cost, or attorney's fees.

GP-62 EQUAL EMPLOYMENT OPPORTUNITY

The State of Louisiana is an equal opportunity employer, and looks to its Contractor, subcontractors, vendors and suppliers to take affirmative action to effect this commitment in its operations.

By submitting the bid proposal and executing the Contract, the Contractor agrees to abide by the requirements of the following as applicable: Title VI and VII of the Civil Rights Act of 1964, as amended by the Equal Opportunity Act of 1972, Federal Executive Order 11246, the Federal Rehabilitation Act of 1973, as amended, the Vietnam Era Veterans Readjustment Assistance Act of 1974, Title IX of the Education Amendments of 1972, and the Age Act of 1975, and the Contractor agrees to abide by the requirements of the Americans with Disabilities Act of 1990.

The Contractor agrees not to discriminate in its employment practices, and will render services the Contract, without regard to their race, age, color, religion, sex, national origin, veteran status, political affiliation or disabilities. Any act of discrimination committed by the Contractor, or failure to comply with these statutory obligations when applicable, shall be grounds for termination of the Contract.

GP-63 ANTI-KICKBACK CLAUSE

The Contractor agrees to adhere to the mandate dictated by the Copeland "Anti-Kickback" Act which provides that each contractor or subcontractor shall be prohibited from inducing, by any means, any person employed in the completion of the work, to give up any part of the compensation to which he is otherwise entitled.

GP-64 SUSPENSION/DEBARMENT

Contractor certifies, by signing and submitting any bid, that their company, any subcontractors, or principals are not suspended or debarred by the General Services Administration (GSA) in accordance with the requirements in OMB Circular A-133. A list of parties who have been suspended or debarred can be viewed via the internet at www.epls.gov.

Contractor agrees to secure from any contractor(s) and subcontractor(s) for the captioned project, certification that such contractor(s) and subcontractor(s) are not suspended, debarred or declared ineligible from entering into contracts with any department or agency of the Federal Government or of the State of Louisiana, or in receipt of a notice of proposed debarment or suspension.

Contractor shall provide immediate notice to Owner in the event of it or its contractor(s) or any subcontractor(s) being suspended, debarred or declared ineligible by any department or agency of the Federal Government or of the State of Louisiana, or upon receipt of a notice of a proposed debarment or suspension, either prior to or after execution of this Contract.

Upon receipt of notice of suspension, debarment, or declaration that Contractor or its

contractor(s) or any subcontractor(s) is/are ineligible to enter into contracts with any department or agency of the Federal Government or of the State of Louisiana, either prior to or after execution of this Contract, Owner reserves the right to review cause for said debarment, suspension, or declaration of ineligibility, and to terminate this Contract pursuant to the terms of GP-45 OWNER'S RIGHT TO TERMINATE CONTRACT FOR CAUSE OR CONVENIENCE, or take such other action it deems appropriate under this Contract.

END OF PART I - GENERAL PROVISIONS

PART II
SPECIAL PROVISIONS

PART II SPECIAL PROVISIONS

SP-1 LOCATION OF WORK

The Work site is located in St. Mary Parish near Franklin, LA. The site is a fallow agricultural field located south of U.S. Highway 90 and just outside the city limits of Franklin. The proposed site is that area at the confluence of Yokely Canal and Franklin Canal.

SP-2 WORK TO BE DONE

The Contractor shall provide all labor, materials, and equipment necessary to perform the Work. The Work shall be performed in accordance with these Specifications and in conformity to lines, grades, and elevations shown on the Plans or as directed by Engineer. Quantity calculations, layouts, shop drawings, and construction sequencing of these items shall be provided in the Work Plan. The major tasks associated with the Work are described as follows:

- Mobilization and demobilization
- Precast concrete piles, capsills and platform deck pump station structure
- Articulated concrete units for sump bottom
- 18' x 50' Pre-engineered metal building pump station enclosure
- 42-inch pump systems, including pump intake, pump unit, engine unit and exhaust system
- 12" Steel pipe piles for discharge pipe supports
- 42" discharge pipes with support saddles and floodwall penetration assembly
- Steel trash screens
- Gas service lines to pump engines
- Electrical service and fixtures
- Approximately 800 linear feet of aggregate roadway on levee crown
- Placement of on-site (stockpiled) rip rap
- Seeding and Fertilizing (site restoration)

SP-3 BID ITEMS, CONTRACT DATES, AND DELIVERABLES

Milestone	Location or Recipient	Date Due	Specification
Bid Advertisement	Publications	As advertised	N/A
Mandatory Pre-Bid Conference and Optional Site Visit	Provided in Advertisement for Bids	As advertised	Advertisement for Bids
Questions on Bid Documents	Deliver to CPRA	As Announced at Pre-Bid Conference	GP-5
Effective Date of Contract	Contractor and Owner	Stated in Contract	Contract
Start of Contract Time	Contractor and Owner	As stated in Notice to Proceed	GP-7
List of Subcontractors	Submit to Engineer	Prior to awarding subcontracts	GP-19
Dredging Plan	Submit to Engineer	45 days prior to commencement of dredging	GP-8, SP-6
Work Plan	Submit to Engineer	At least 14 days prior to Pre-Construction Conference	GP-8
Progress Schedule	Submit to Engineer	At least 14 days prior to starting construction, bi-weekly thereafter	GP-9
Pre-Construction Conference	Contractor and Engineer	As determined by the Engineer after Notice to Proceed is issued	GP-14
Daily Progress Reports	Resident Project Representative	Daily by 12pm (noon). (see Appendix H for template)	GP-10
Progress Meetings and Reports	At Project Site	Bi-weekly or as determined at the Pre-Construction Conference	GP-13, GP-39
Notice of Substantial Completion	Submit to Engineer	Upon substantial completion of work	GP-53
Final Inspection and Acceptance	Submit to Engineer	Upon completion of work	GP-54
As-Built Drawings	Deliver to Engineer	Prior to Final Inspection as scheduled by the Engineer	GP-55
End of Contract Time	At Project Site	300 calendar days after Notice to Proceed for Base Bid (30 and 30 additional calendar days for Alternate Bids 1 and 2 respectively)	Instructions to bidders

SP-4 DELIVERABLES

4.1 Prior to Construction

4.1.1 The Contractor shall submit the following documents to the Engineer prior to the Pre-Construction Conference specified in GP-14:

4.1.1.1 Work Plan as specified in GP-8 & SP-6;

4.1.1.2 Progress Schedule as specified in GP-9;

4.1.1.3 Copy of typical Daily Progress Report as specified in GP-10.

4.1.1.4 Hurricane and Severe Storm Plan as specified in GP-11;

4.1.1.5 Health and Safety Plan as specified in GP-12.

4.1.1.6 List of all subcontractors as specified in GP-19.

4.1.1.7 Superintendent Qualifications as specified in GP-20.4.1.2 The Contractor shall provide the following information to the Engineer at the Pre-Construction Conference specified in GP-14:

4.1.1.8 Updates to all plans and schedules based on comments from the Engineer;

4.1.1.9 Potential construction corridors (if needed, other than from what is provided) which may be approved on an as needed basis.

4.1.2 Preconstruction survey as specified in Section 01 01 12.

4.1.3 Complete Contractor-prepared SWPPP

4.1.4 Float Plan for all on-water activities

4.2 During Construction

The Contractor shall deliver copies of the following documents upon request by the Engineer, or as specified in these provisions:

4.2.1 The results of all surveys and calculations as specified in the Technical Specifications

4.2.2 Progress Schedule as specified in GP-9;

4.2.3 Daily Progress Reports as specified in GP-10;

4.2.4 Progress meeting reports as specified in GP-13;

- 4.2.5 Copies of all inspection reports;
- 4.2.6 All Change Orders, Field Orders, Claims, Clarifications, and Amendments;
- 4.2.7 Results of any materials testing.

4.3 Administrative Records

4.3.1 Notice of Intent to Conduct In-channel Construction Operations

The Contractor is required to maintain a 20-foot clear navigation channel at all times as noted herein and in accordance with GP 37. At least 30 days prior to commencement of Work on this Contract, the Contractor shall notify the U.S. Coast Guard, Sector New Orleans Command Center, at the address below, of his intended operations and request that it be published in the Local Notice to Mariners. This notification must be given in sufficient time so that it appears in the Notice to Mariners at least seven (7) days prior to the commencement of this construction operation. A copy of the Department of the Army Permit and drawings shall be provided to the U.S. Coast Guard. A copy of the notification shall be provided to the Owner and Engineer.

U.S. Coast Guard
Sector New Orleans Command Center
201 Hammond Hwy
Metairie, LA 70005
504-846-5923

4.3.2 Navigational Aids

Temporary removal of any navigation aids located within or near the construction area is not permitted. The Contractor shall not remove, change the location of, obstruct, willfully damage, make fast to, or interfere with any aid to navigation. The Contractor shall notify the Eighth U.S. Coast Guard District, New Orleans, Louisiana, in writing, with a copy to the Owner and Engineer, seven (7) days in advance of the time he plans to Work adjacent to any aids

4.3.3 In-Channel Construction Aids

The Contractor shall obtain approval for all in-channel construction vessels, including but not limited to temporary navigation aids, warning signs, buoys, and lights, he requires to conduct the Work specified in this Contract. The Contractor shall obtain a temporary permit from the U.S. Coast Guard for all buoys or construction vessel markers to be placed in the water prior to installation. The permit application shall state the position, color, and dates to be installed and removed for all dredging aid markers and be submitted to the U.S. Coast Guard. Construction vessel markers and lights

shall not be colored or placed in a manner that they will obstruct or be confused with navigation aids. Copies of the application and permit shall be submitted to the Owner and Engineer seven (7) days prior to commencement of dredging operations.

4.3.4 Notification of Discovery of Historical or Cultural Sites

If during construction activities the Contractor observes items that may have prehistoric, historical, archeological, or cultural value, the Contractor shall immediately cease all activities that may result in the destruction of these resources and shall prevent his employees from trespassing on, removing, or otherwise damaging such resources. Such observations shall be reported immediately to the Owner and Engineer so that the appropriate authorities may be notified and a determination made as to their significance and what, if any, special dispositions of the finds should be made. The Contractor shall report any observed unauthorized removal or destruction of such resources by any person to the Owner and Engineer so the appropriate State of Louisiana authorities can be notified. The Contractor shall not resume Work at the site in question until State authorities have rendered judgment concerning the artifacts of interest.

4.4 Post Construction

The Contractor shall contact the Engineer by phone, a minimum of five (5) working days prior to the anticipated completion of the Work in order to schedule the final inspection and gain Acceptance by the Engineer. The following documents shall also be submitted to the Engineer:

4.4.1 Copies of all delivery slips, which shall include the source of construction materials, date of delivery, exact quantity, and size of materials delivered with each shipment to the Project Site;

4.4.2 As-Built Drawings as specified in the Technical Specifications.

4.4 Deliverables and submittals not noted above but as called for by the Engineer in the plans and specifications.

SP-5 ADDRESSES FOR DOCUMENT DELIVERY

After execution of the contract between Owner and Contractor, the successful Contractor shall contact the Engineers concerning bid documentation or questions. The addresses and contact information for the Engineers are listed as follows:

CPRA Project Engineer
Shannon Haynes, P.E.
P.O. Box 4407
Baton Rouge, Louisiana 70804-4027

Phone: 225-342-5175
Fax: 225-342-9424
E-mail: Shannon.Haynes@la.gov

CPRA Field Engineer
Stanley Aucoin
635 Cajundome Blvd.
P.O. Box 62027
Lafayette, Louisiana 70596
Phone: 337-482-0681
Fax: (337)482-0685
E-mail: Stanley.Aucoin@la.gov

The Owner and Engineer shall deliver all written Claims, Notices, Submittals, Plans, and other documents to the Contractor at the address indicated on the Bid.

SP-6 WORK PLAN SUPPLEMENTAL

The following items shall be included in the Work Plan in addition to those required by GP-8; Submittals as specified in SP-19.

SP-7 FAILURE TO COMPLETE ON TIME

For each day the Work remains incomplete beyond the Contract Time, as specified in SP-3, or Extension of Contract Time, as specified in GP-44, the sum of two thousand four hundred fifty (**\$2450.00**) per calendar day will be deducted from any money due to the Contractor as liquidated damages. The Contractor and Surety shall be liable for any liquidated damages that are in excess of the amount due the Contractor.

SP-8 OFFICE FOR OWNER

The Contractor shall provide an office for the Engineer and Resident Project Representative at the Project Site if requested by the Engineer. This office shall be for the sole use of the Engineer or Resident Project Representative, suitably sized, and provided with lighting, heat, air conditioning, and reliable internet connectivity. The office furnishings shall include a work table, drafting table, stool, and two chairs.

In the event that the Contractor refuses, neglects, or delays compliance with the requirements of this provision, the Owner may obtain and use another necessary office at the expense of the Contractor. The cost for providing and furnishing this office shall be included in the contract lump sum price for Bid Item No. 1, "Mobilization and Demobilization".

SP-9 LANDOWNER and UTILITY REQUIREMENTS

The Owner has obtained all temporary easement, servitude, and right-of-way agreements required for construction of the project. The agreements executed with landowners for the Work at the site contain special requirements pertaining to access routes and insurance. A land rights memorandum will be furnished to the Contractor.

The Contractor shall abide by the stipulations set forth by the respective landowners (Grantors):

LANDOWNER	CONTACT INFORMATION
TRACT 1 PONTIFF	Wilbur J. Pontiff 112 Michael Dr. Franklin, La 70538
TRACT 2 Estate of D. Caffery, Jr., and Estate of R.E. Caffery	CONTACT: <u>D.Caffery, Jr.</u> – c/o Elizabeth Ary, JP Morgan, Trust Officer/VP (Caroline Baker Trust #1) 201 St. Charles Ave. 28 th Floor, New Orleans, La 70170; c/o Rader Jackson (DC Jr. Partnership), 1010 Common St., Suite 1800, New Orleans, La 70112. <u>R.E.Caffery</u> – c/o Patrick Caffery, Jr., 603 Center St., New Iberia, La 70560
TRACT 3 NEW 90, LLC	James Bailey P.O. Box 842 Baton Rouge, La 70821
TRACT 4 USFWS	c/o Ken Clough Senior Realty Specialist 6578 Dogwood View Pkwy. Jackson Ms. 39213

The Contractor shall add the landowners listed above as additional insured. It is also agreed and understood that the Contractor will at all times indemnify and hold harmless all landowners from and against any and all claims, demands, causes of action, judgments, liabilities, and expense of every nature, including attorney’s fees, by reason of personal injury, death (including but not limited to injuries to and death of employees of the landowners and the Contractor’s employees) or damage to property, (including environmental) which arises out of, results from, or is in any manner related to, directly or indirectly, any operations or acts hereunder, or to the exercise of your rights hereunder, or to your presence upon or use of the landowners’ premises above referred to, or to the use or existence of your facilities on such premises. The indemnity provisions of this paragraph shall not apply if any such injury, death, damage, liability claim, or cause of action is caused by the negligence of the landowners, their employees, agents, or representatives.

The Contractor shall notify all pipeline companies at least seventy-two (72) hours in advance of any construction work. All pipelines located within one hundred fifty feet (150’) of the work area shall be probed and their locations marked for the duration of construction activities. See the Technical Specifications for utility coordination and overhead lines compliance.

UTILITY COMPANY	CONTACT ADDRESS NAME & PHONE NUMBER
CLECO (OVERHEAD TRANSMISSION LINE)	P.O. BOX 489 NEW IBERIA, LA. 70562 CONTACT: RON ALBARADO TEL: (337) 369-8235
GULF SOUTH PIPELINE (BOARDWALK PIPELINE PARTNERS)	2300 VEROT SCHOOL ROAD LAFAYETTE, LA. 70508 CONTACT: KAREN GORMAN CELL: (337) 224-0895
COLUMBIA GULF PIPELINE	201 ENERGY CENTER PKWY., SUITE 100 LAFAYETTE, LA. 70508 CONTACT: KERRY WHITMAYER TEL: (337) 262-4695
ST. MARY PARISH CONSOLIDATED GRAVITY DRAINAGE DISTRICT (2" GAS LINE)	P.O. BOX 668 BALDWIN, LA. 70514 CONTACT: ROBBIE ROBISON CELL: (337) 207-5408

All known utilities within the limits of the Work, such as pipes, communication lines, power lines, etc., that would interfere with construction Work will be removed, modified or relocated by local interests or utility companies at no cost to the CONTRACTOR unless otherwise noted in the plans and/or specifications. The CONTRACTOR, however, shall cooperate with the authorities or company representatives and shall conduct his/her operations in such manner as to result in a minimum of inconveniences to the owners of said utilities. The CONTRACTOR shall notify each utility owner by certified mail 45 days, 15 days, and again 72 hours by telephone prior to the date utilities must be moved and provide a copy of these notifications to the ENGINEER.

Any unidentified pipes or structures which may be found within the limits of the Work during the course of construction shall not be disturbed nor shall construction or excavation be performed at these locations unless and until approved by the ENGINEER.

SP-10 OYSTER LEASE RESTRICTIONS

There are no known existing oyster leases near or within the boundaries of the Project Site. Therefore, no oyster lease restrictions are provided for performing the Work within the boundaries of the Project Site.

SP-11 THREATENED AND ENDANGERED SPECIES

The Environmental Assessment for this project identifies no threatened or endangered species within the boundaries of the Project Site.

SP-12 COMMUNICATION

The CONTRACTOR shall have someone available to take calls at all times. He shall provide the OWNER and ENGINEER with a local night telephone number to call so that he may be advised of any emergency, trouble, or other matter needing his attention. The emergency telephone number should be displayed on barricades and/or on equipment on the job site.

SP-13 EXISTING CONDITIONS

The Franklin Canal water surface varies with meteorological and tidal conditions. Mean High Water (MHW) is EL +2.5. Mean Low Water (MLW) is EL +1.0. Contractor shall familiarize himself with varying tidal conditions and account for such in work plan.

Newly constructed flood control structures and levees are within the bounds of the project construction site. CONTRACTOR shall exercise extreme care around existing structures and levees both above and below ground and water. CONTRACTOR is responsible for repairing any and all damage incurred to existing works in accordance with GP-22. Landside transport of materials, equipment and personnel to the site shall be east of the levee toe of slope and within the temporary right of way.

Obstructions encountered prior to and during pile driving shall be cleared with no direct pay.

SP-14 FLOATING PLANTS

All floating plants (working platform barge(s) or other) used on this contract and not subject to U. S. Coast Guard Inspection and certification, must be inspected and certified seaworthy by a reputable marine surveyor who is recognized in the trade. The certificate must be applicable for the intended use, must be less than one year old, and must be submitted to the ENGINEER before the start of Work. All other plant shall be inspected annually by a qualified person and posted in a public place.

SP-15 AS-BUILTS

As-builts shall be submitted to the Engineer in digital (AutoCAD) format and 11"X17" hard copy (3 copies). The drawing shall incorporate all field changes and change orders.. All revisions shall be shown in red and be easily distinguishable from the original design. The drawing shall be stamped by a professional surveyor or engineer licensed in state of Louisiana as applies.

SP-16 POINT FILES

ASCII point file of installed piles, capsills, platform panels, discharge pipe support inverts at centerline of pipe, the levee centerline, crown, and roadway sections shall accompany all submittals (the existing, and final as-built(s), and any interim submittals for payment). The point files for the roadway shall be taken at 100-foot

intervals and at all changes of direction. Point files for the roadway and structures shall include the following information:

- Point number
- Northing (NAD 83 US. FT.)
- Easting (NAD 83 US. FT.)
- Elevation (NAVD 88 FT.)
- Description

The description shall include callouts using nomenclature and terms as indicated in the plans.

SP-17 SHOP DRAWINGS

Fabricated and manufactured components require detailed shop drawings as per articles GP-8 of the General Conditions. This includes items such as:

- Complete Pump System including layout of equipment and items on skids
- Electrical Service System
- Lighting System
- Roll-up Doors
- Precast Concrete Fabrications
- Structural Steel Fabrications
- All other items as called for in plans and specifications

SP-18 OBSTRUCTION OF NAVIGATION WATERWAYS

The CONTRACTOR is required to salvage anything sunk, lost overboard, or incorrectly placed during construction that may pose a hazard to navigation at no additional expense to the OWNER. Any objects, as described above, cannot be left in place or abandoned to the OWNER; the object has to be adequately marked throughout the interval of the loss of the object and the completion of salvage.

SP-19 PUMP SYSTEM INSTALLATION

The Contractor shall install, test and demonstrate complete, fully functional pump systems as indicated in the plans and specifications. Pump system shall operate at multiple speeds absent of vibration in units and support structure.

Pump System components include but are not limited to:

- Vertical Axial Flow Pump
- Propeller Pump Gear Reducer
- Natural Gas Engine
- Lube-Oil System
- Cooling System
- Exhaust System
- Equipment skids, hangars and supports

- Finishes and Cathodic Protection
- Shut-off switches (float and vibration)
- Cooling system ductwork and louvers

SP-20 OPERATIONS AND MAINTENANCE – FIELD DEMONSTRATION, TRAINING AND MANUAL

Contractor shall provide a demonstration and training of the pump system and provide materials for O&M manuals as required in the specifications.

SP-21 CPRA CONSTRUCTION INSURANCE PROVISIONS

INSURANCE AND BONDS

INSURANCE REQUIREMENTS FOR
NEW CONSTRUCTION, ADDITIONS AND RENOVATIONS

21.1 The Contractor shall purchase and maintain without interruption for the duration of the contract insurance against claims for injuries to persons or damages to property which may arise from or in connection with the performance of the Work hereunder by the Contractor, its agents, representatives, employees, or subcontractors. The duration of the Contract shall be from the inception of the Contract until the date of final payment.

21.2 Minimum Scope and Limits of Insurance

21.2.1 Worker's Compensation

Worker's Compensation insurance shall be in compliance with the Worker's Compensation law of the State of Louisiana. Employers Liability is included with a minimum limit of \$500,000 per accident/per disease/per employee. If Work is to be performed over water and involves maritime exposure, applicable LHWCA, Jones Act or other maritime law coverage shall be included and the Employers Liability limit increased to a minimum of \$1,000,000. A.M. Best's insurance company rating requirement may be waived for Worker's compensation coverage only.

21.2.2 Commercial General Liability

Commercial General Liability insurance, including Personal and Advertising Injury Liability and Products and Completed Operations Liability, shall have a minimum limit per occurrence based on the project value. The Insurance Services Office (ISO) Commercial General Liability occurrence coverage form CG 00 01 (current form approved for use in Louisiana), or equivalent, is to be used in the policy. Claims-made form is unacceptable.

The aggregate loss limit must apply to each project. ISO form CG 25 03 (current form approved for use in Louisiana), or equivalent, shall also be

submitted. The State project number, including part number, and project name shall be included on this endorsement.

COMBINED SINGLE LIMIT (CSL) PER OCCURRENCE

The required minimum combined single limit amount of insurance shall be as provided below:

<u>Initial Contract Amount</u>	<u>Minimum Insurance</u>
Up to \$1,000,000	\$1,000,000
From \$1,000,001 to \$2,000,000	\$2,000,000
Over \$2,000,000	\$5,000,000

21.2.3 Automobile and Watercraft Liability

Automobile Liability Insurance and Watercraft Liability Insurance shall have a minimum combined single limit per occurrence of \$1,000,000. ISO form number CA 00 01 (current form approved for use in Louisiana), or equivalent, is to be used in the policy. This insurance shall include third-party bodily injury and property damage liability for owned, hired and non-owned automobiles and/or watercraft. If any non-licensed motor vehicles and/or watercraft are engaged in operations within the terms of the contract on the site of the work to be performed thereunder, such insurance shall cover the use of any such vehicles.

NOTE: If the Contractor does not own automobiles and/or watercraft, and such vehicles are utilized in the execution of the contract, then hired and non-owned coverage is acceptable. If automobiles and/or watercraft are not utilized in the execution of the contract, then automobile and/or watercraft coverage is not required.

21.2.4 Excess Umbrella

Excess Umbrella Insurance may be used to meet the minimum requirements for General Liability, Automobile Liability, and Watercraft Liability only.

21.2.5 Pollution Liability (required when asbestos or other hazardous material abatement is included in the contract)

Pollution Liability insurance, including gradual release as well as sudden and accidental, shall have a minimum limit of not less than \$1,000,000 per claim. A claims-made form will be acceptable. A policy period inception date of no later than the first day of anticipated Work under this contract and an expiration date of no earlier than 30 days after anticipated completion of all Work under the contract shall be provided. There shall be an extended reporting period of at least 24 months, with full reinstatement of limits, from the expiration date of the policy. The policy shall not be cancelled for any reason, except non-payment of premium.

21.2.6 Deductibles and Self-Insured Retentions

Any deductibles or self-insured retentions must be declared to and accepted by the Owner. The Contractor shall be responsible for all deductibles and self-insured retentions.

21.3 OTHER INSURANCE PROVISIONS

21.3.1 The policies are to contain, or be endorsed to contain, the following provisions:

21.3.1.1 Worker's Compensation and Employers Liability Coverage

21.3.1.1.1 The insurer shall agree to waive all rights of subrogation against the Owner, its officers, agents, employees and volunteers for losses arising from Work performed by the Contractor for the Owner.

21.3.1.2 General Liability Coverage

21.3.1.2.1 The Owner, its officers, agents, employees and volunteers are to be added as additional insureds as respects liability arising out of activities performed by or on behalf of the Contractor; products and completed operations of the Contractor, premises owned, occupied or used by the Contractor. ISO Form CG 20 10 (current form approved for use in Louisiana), or equivalent, is to be used.

21.3.1.2.2 The Contractor's insurance shall be primary as respects the Owner, its officers, agents, employees and volunteers. The coverage shall contain no special limitations on the scope of protection afforded to the Owner, its officers, officials, employees or volunteers. Any insurance or self-insurance maintained by the Owner shall be excess and non-contributory of the Contractor's insurance.

21.3.1.2.3 The Contractor's insurance shall apply separately to each insured against whom claim is made or suit is brought, except with respect to the policy limits.

21.3.1.3 All Coverages

21.3.1.4.1 Coverage shall not be canceled, suspended, or voided by either party (the Contractor or the insurer) or reduced in coverage or in limits except after 30 days written notice has been given to the Owner. Ten-day written notice of cancellation is acceptable for non-payment of premium. Notifications shall comply with the standard cancellation provisions in the Contractor's policy.

- 21.3.1.4.2 Neither the acceptance of the completed Work nor the payment thereof shall release the Contractor from the obligations of the insurance requirements or indemnification agreement.
- 21.3.1.4.3 The insurance companies issuing the policies shall have no recourse against the Owner for payment of premiums or for assessments under any form of the policies.
- 21.3.1.4.4 Any failure of the Contractor to comply with reporting provisions of the policy shall not affect coverage provided to the Owner, its officers, agents, employees and volunteers.

21.3.2 ACCEPTABILITY OF INSURERS

All required insurance shall be provided by a company or companies lawfully authorized to do business in the jurisdiction in which the Project is located. Insurance shall be placed with insurers with an A.M. Best's rating of A-:VI or higher. This rating requirement may be waived for Worker's compensation coverage only.

If at any time an insurer issuing any such policy does not meet the minimum A.M. Best rating, the Contractor shall obtain a policy with an insurer that meets the A.M. Best rating and shall submit another certificate of insurance as required in the contract.

21.3.3 VERIFICATION OF COVERAGE

Contractor shall furnish the Owner with Certificates of Insurance reflecting proof of required coverage. The Certificates for each insurance policy are to be signed by a person authorized by that insurer to bind coverage on its behalf. The Certificates are to be received and approved by the Owner before Work commences and upon any contract renewal thereafter. The Certificate Holder must be listed as follows:

State of Louisiana
 Name of Owner
 Owner Address
 City, State, Zip
 Attn: Project # _____

In addition to the Certificates, Contractor shall submit the declarations page and the cancellation provision endorsement for each insurance policy. The Owner reserves the right to request complete certified copies of all required insurance policies at any time.

Upon failure of the Contractor to furnish, deliver and maintain such insurance as above provided, this contract, at the election of the Owner, may be suspended, discontinued or terminated. Failure of the Contractor to purchase and/or maintain any required insurance shall not relieve the Contractor from any liability or indemnification under the contract.

If the Contractor does not meet the insurance requirements at policy renewal, at the option of the Owner, payment to the Contractor may be withheld until the requirements have been met, OR the Owner may pay the renewal premium and withhold such payment from any monies due the Contractor, OR the contract may be suspended or terminated for cause.

21.3.4 SUBCONTRACTORS

Contractor shall include all subcontractors as insureds under its policies OR shall be responsible for verifying and maintaining the certificates provided by each subcontractor. Subcontractors shall be subject to all of the requirements stated herein. The Owner reserves the right to request copies of subcontractor's certificates at any time.

If Contractor does not verify subcontractors' insurance as described above, Owner has the right to withhold payments to the Contractor until the requirements have been met.

21.3.5 WORKER'S COMPENSATION INDEMNITY

In the event Contractor is not required to provide or elects not to provide Worker's compensation coverage, the parties hereby agree the Contractor, its Owners, agents and employees will have no cause of action against, and will not assert a claim against, the State of Louisiana, its departments, agencies, agents and employees as an employer, whether pursuant to the Louisiana Worker's Compensation Act or otherwise, under any circumstance. The parties also hereby agree that the State of Louisiana, its departments, agencies, agents and employees shall in no circumstance be, or considered as, the employer or statutory employer of Contractor, its Owners, agents and employees. The parties further agree that Contractor is a wholly independent Contractor and is exclusively responsible for its employees, Owners, and agents. Contractor hereby agrees to protect, defend, indemnify and hold the State of Louisiana, its departments, agencies, agents and employees harmless from any such assertion or claim that may arise from the performance of this contract.

21.3.6 INDEMNIFICATION/HOLD HARMLESS AGREEMENT

Contractor agrees to protect, defend, indemnify, save, and hold harmless, the State of Louisiana, all State Departments, Agencies, Boards and Commissions, its officers, agents, servants, employees and volunteers, from and against any and all claims, damages, expenses and liability arising out of injury or death to any person or the damage, loss or destruction of any property which may occur, or in any way grow out of, any act or omission of Contractor, its agents, servants and employees, or any and all costs, expenses and/or attorney fees incurred by Contractor as a result of any claims, demands, suits or causes of action, except those claims, demands, suits or causes of action arising out of the negligence of the State of Louisiana, all State Departments, Agencies, Boards, Commissions, its officers, agents, servants, employees and volunteers.

Contractor agrees to investigate, handle, respond to, provide defense for and defend any such claims, demands, suits or causes of action at its sole expense and agrees to

bear all other costs and expenses related thereto, even if the claims, demands, suits, or causes of action are groundless, false or fraudulent.

21.4 PERFORMANCE AND PAYMENT BOND

Add the following Subparagraph 21.4.3:

21.4.3 RECORDATION OF CONTRACT AND BOND [38:2241A(2)]

The Owner shall record within thirty (30) days the Contract Between Owner and Contractor and Performance and Payment Bond with the Clerk of Court in the Parish in which the Work is to be performed.

END OF PART II – SPECIAL PROVISIONS

TECHNICAL SPECIFICATIONS

DIVISION 01
GENERAL REQUIREMENTS

SECTION 01010
MOBILIZATION AND DEMOBILIZATION

INDEX

SECTION 01 01 0 - MOBILIZATION AND DEMOBILIZATION

PART 1 GENERAL..... 2
1.1 SCOPE2
1.2 REFERENCES2
1.3 MEASUREMENT AND PAYMENT2
1.3.1 Arbitrary Mobilization by CONTRACTOR.....2
1.3.2 Ratio of Mobilization and Demobilization Effort.....2
1.3.3 Justification of Mobilization Costs.....2
1.4 SUBMITTALS2
PART 2 PRODUCTS..... 2
PART 3 EXECUTION..... 3

SECTION 01010

MOBILIZATION AND DEMOBILIZATION

PART 1 GENERAL

1.1 SCOPE

This Work consists of preparatory Work and operations, including those necessary for movement of personnel, equipment supplies and incidentals to the project site; the establishment of offices, buildings and other facilities necessary for Work on the project; the cost of bonds and any required insurance; and other pre-construction expenses necessary for start of the Work, excluding the cost of construction materials.

This Work shall also consist of post construction Work and operations, including those necessary to undo/remove any of the above mentioned items.

Reimbursement for this item shall not exceed 10% of the contract base bid.

1.2 REFERENCES

NOT USED

1.3 MEASUREMENT AND PAYMENT

All costs connected with mobilization and demobilization of all the CONTRACTOR's plant, equipment, personnel, and those of his subcontractors and such others costs as may be denoted in the contract documents shall be paid for at the contract lump sum price for Bid Item: "Mobilization & Demobilization."

1.3.1 Arbitrary Mobilization by CONTRACTOR

The OWNER will pay for mobilization and demobilization only once. Should the CONTRACTOR elect to demobilize prior to completing the project, such demobilization and subsequent remobilization shall be at no cost to the OWNER.

1.3.2 Ratio of Mobilization and Demobilization Effort

Sixty percent (60%) of the lump sum price will be paid to the CONTRACTOR upon completion of his mobilization at the work site and the remaining forty percent (40%) will be paid to the CONTRACTOR upon completion of demobilization.

1.3.3 Justification of Mobilization Costs

In the event that the ENGINEER considers the amount in this item, sixty percent (60%) and forty percent (40%) which represents mobilization and demobilization respectively does not bear a reasonable relation to the cost of the Work in this contract, the ENGINEER may require the CONTRACTOR to produce cost data to justify this portion of the bid. Failure to justify such price to the satisfaction of the ENGINEER will result in payment of actual mobilization costs, as determined by the ENGINEER at the completion of mobilization, and actual demobilization costs at the completion of demobilization, and payment of the remainder of this item in the final payment under this contract. The determination of the ENGINEER is not subject to appeal.

1.4 SUBMITTALS

NOT USED

PART 2 PRODUCTS

Franklin Canal Pump Station

NOT USED

PART 3 EXECUTION

NOT USED

-- End of Section --

SECTION 01 01 02
SURVEYING

INDEX
SECTION 01 01 02 SURVEYING

PART 1	GENERAL.....	2
1.1	SCOPE	2
1.2	REFERENCES	2
1.3	MEASUREMENT AND PAYMENT	2
1.4	SUBMITTALS	2
1.4.1	Pre-Construction Survey	2
1.4.1.1	Temporary Benchmarks (TBMs)	2
1.4.1.2	Pump Station Location	2
1.4.1.3	Levee Cross Sections	3
1.4.1.4	Existing Timber Piles	3
1.4.1.5	Existing Floodwall Sheet Piles and Battered Piles	3
1.4.2	Construction Surveys	3
1.4.2.1	Intake Basin Survey	3
1.4.2.2	Piles	4
1.4.2.2.1	Concrete Piles	4
1.4.2.2.2	Steel Pipe Piles	4
1.4.2.3	Pile Caps	4
1.4.2.3.1	Concrete Pile Caps	4
1.4.2.3.2	Discharge Pipe Pile Caps/Supports	4
1.4.2.4	Pump Station Slab	4
1.4.2.5	Discharge Piping	4
1.4.2.6	Limestone Road	4
1.4.3	As-Built Surveys	4
1.4.3.1	Drawings	4
1.4.4	Point Files	5

SECTION 01 01 02

SURVEYING

PART 1 GENERAL

1.1 SCOPE

The scope consists of the surveying as required in this Specification or as shown on the Plans. There is an existing bench mark in the area which is to be used for this project. This benchmark will be used for all horizontal and vertical control. A data sheet for the benchmark is included. All surveying work listed in this section shall be performed under the direct supervision of a professional land surveyor (PLS) licensed in the state of Louisiana unless otherwise stated. All Drawings shall be stamped by the surveyor and shall reference the North American Datum of 1983, Louisiana South Zone, U.S. Survey Feet, and the North American Vertical Datum of 1988, U.S. Survey Feet.

1.2 REFERENCES

NOT USED

1.3 MEASUREMENT AND PAYMENT

All costs associated with pre-construction, construction, as-built surveys, and as may be denoted in the contract documents shall be included in the contract lump sum price for Bid Item: "Surveying." All surveying required in this section shall be performed by a professional surveyor licensed in the state of Louisiana.

1.4 SUBMITTALS

1.4.1 Pre-Construction Survey

Any temporary benchmarks to be utilized shall be surveyed after the Pre-Construction Conference and prior to construction. This survey shall be used to verify the alignment of the various project features and make modifications or adjustments as deemed necessary by the ENGINEER. These shall be submitted to the ENGINEER.

1.4.1.1 Temporary Benchmarks (TBMs)

TBMs shall be installed by the CONTRACTOR at locations necessary for construction of the project. Horizontal and vertical coordinates shall be determined for all TBMs installed. The CONTRACTOR shall maintain the TBMs for the duration of construction at the CONTRACTOR's expense. In the event that a single TBM is disturbed and/or destroyed, the TBM may be reinstalled by a qualified CONTRACTOR employee approved by the ENGINEER. If multiple TBMs are destroyed, the ENGINEER may require the TBMs to be reinstalled by a PLS. All TBMS shall be resurveyed every 30days by a PLS and that survey data submitted to the ENGINEER.

1.4.1.2 Pump Station Location

Franklin Canal Pump Station

A pre-construction survey of the pump station area will be required prior to construction. Survey shall include sheet piles bounding the pump station sump. Survey shall include sheet piles bounding the pump station sump. Cross sections will be taken every 10 feet perpendicular to the channel centerline in the areas. The area identified as the pump station intake basin will be surveyed on a 5' grid to assure a level surface for the proposed articulating concrete blocks. The cross sections taken shall be submitted to the ENGINEER digitally in ASCII, AutoCAD® format and 11" x 17" hard copy. The drawings and data must be approved by the ENGINEER prior to the commencement of work.

1.4.1.3 Levee Cross Sections

The existing levee will be surveyed from station 2+00 to station 8+94, spaced 100' a part perpendicular to the levee centerline, and will be surveyed prior to limestone road construction. Shots along the cross section shall extend from either side of the levee 100'. Survey points shall be taken at a minimum at the levee toe, crown, centerline, breakpoints, utilities, and drainage features. Elevations shall be obtained at a maximum of 5' intervals. All drawings shall be submitted to the ENGINEER digitally in AutoCAD® format and 11"x17" hard copy. The drawings and data must be approved by the ENGINEER prior to the commencement of work.

1.4.1.4 Existing Timber Piles

The existing timber piles on the flood side of the flood control structure will be surveyed. These piles will support the discharge pipes for the proposed pump station. The drawings and data must be approved by the ENGINEER prior to the commencement of work.

1.4.1.5 Existing Floodwall Sheet Piles and Battered Piles

The existing floodwall sheet piles and battered piles on the north side of the channel will be surveyed. This floodwall will be penetrated by the discharge pipes for the proposed pump station. The drawings and data must be approved by the ENGINEER prior to the commencement of work.

Subsurface location from the mudline to elevation -60 feet of piles BR107 and CA107 shall be determined by method approved by ENGINEER. Piles BS110, BS111, BS113, BS117, BS120, BZ110, BZ111, BZ113, BZ117, and BZ120 shall not be driven until this survey has been approved by ENGINEER.

1.4.2 Construction Surveys

The below shall be surveyed in order for the CONTRACTOR to receive payments for given feature of work during construction.

1.4.2.1 Intake Basin Survey

After concrete pile installation the intake basin will be surveyed on a 5' grid to assure heaving has not occurred due to pile driving. This survey is required to be submitted and approved by the ENGINEER prior to articulating concrete blocks placement. If heaving has occurred and it is above the required elevation for articulating concrete blocks placement this material will be excavated and disposed of by the CONTRACTOR at no direct pay.

Franklin Canal Pump Station

1.4.2.2 Piles

1.4.2.2.1 Concrete Piles

The concrete piles will be surveyed after installation and submitted to the ENGINEER for review and approval prior to installation of the concrete caps.

1.4.2.2.2 Steel Pipe Piles

The steel pipe piles will be surveyed after installation and submitted to the ENGINEER for review and approval prior to installation discharge pipe supports.

1.4.2.3 Pile Caps

1.4.2.3.1 Concrete Pile Caps

The concrete pile caps will be surveyed after installation and submitted to the ENGINEER for review and approval prior to pump station slab installation. Each corner of the concrete cap will be surveyed.

1.4.2.3.2 Discharge Pipe Pile Caps/Supports

The discharge pile caps will be surveyed after installation and submitted to the ENGINEER for review and approval prior to discharge pipe installation.

1.4.2.4 Pump Station Slab

The individual pump station slab panels will be surveyed after placement but prior to grouting and submitted to the ENGINEER for approval prior to final slab installation. The individual slab surveys will consist of survey points on all four corners.

1.4.2.5 Discharge Piping

The discharge piping will be surveyed after placement along its centerline and at every change in grade and inflection points. The surveys will be submitted to the ENGINEER for review and approval.

1.4.2.6 Limestone Road

The limestone road will be surveyed after placement along its centerline and at the intervals described in "Levee Cross Sections". The surveys and drawings will be submitted to the ENGINEER for review and approval.

1.4.3 As-Built Surveys

Final construction surveys will be utilized in the production of the as-built drawings.

1.4.3.1 Drawings

As-built drawing and drawings associated with pre-construction and construction surveys will be submitted to the ENGINEER digitally in AutoCAD® format and 11" x 17" hard copy. As-built drawings shall incorporate all field changes, change orders, and show the actual quantity of material

Franklin Canal Pump Station

placed. All revisions shall be shown in red and be easily distinguishable from the original design. The drawings shall be stamped by a professional surveyor licensed in the state of Louisiana.

1.4.4 Point Files

Point files of all pre-construction, construction, and as-built surveys shall be submitted in electronic format (ASCII) to the ENGINEER. The point files shall contain the following information:

1. Point number
2. Northing (NAD 83 US. FT.)
3. Easting (NAD 83 US. FT.)
4. Elevation (NAVD 88 FT.)
5. Description

-- End of Section --

SECTION 01 57 20.00 12
ENVIRONMENTAL PROTECTION

INDEX

SECTION 01 57 20.00 12 - ENVIRONMENTAL PROTECTION

PART 1 GENERAL..... 2

1.1 SCOPE2

1.2 REFERENCES2

1.3 MEASUREMENT AND PAYMENT3

1.3.1 Environment Protection3

1.3.2 Hazardous/Regulated Waste3

1.4 SUBMITTALS3

1.5 APPLICABLE REGULATIONS3

1.6 QUALITY CONTROL4

1.6.1 General4

1.6.2 Reporting4

1.7 NOTIFICATION4

1.8 IMPLEMENTATION5

1.8.1 Environmental Assessment of Contract Deviations5

PART 2 PRODUCTS (NOT USED)..... 5

PART 3 EXECUTION..... 5

3.1 PROTECTION OF LAND RESOURCES5

3.1.1 General5

3.1.2 Prevention of Landscape Defacement5

3.1.3 Temporary Excavation and Embankments6

3.1.4 Post-Construction Cleanup or Obliteration6

3.1.5 Recording and Preserving Historical and Archeological Finds6

3.2 PROTECTION OF WATER RESOURCES6

3.2.2 Disposal of Materials6

3.3 PROTECTION OF FISH AND WILDLIFE7

3.4 JANITOR SERVICES7

3.5 DISPOSAL OF HAZARDOUS AND/OR REGULATED SOLID WASTES7

3.5.1 Hazardous Wastes8

3.5.2 Regulated Solid Wastes8

3.5.3 Laboratory Accreditation9

3.6 MAINTENANCE OF POLLUTION CONTROL FACILITIES9

3.7 REPORTING OF POLLUTION SPILLS9

SECTION 01 57 20.00 12

ENVIRONMENTAL PROTECTION

PART 1 GENERAL

1.1 SCOPE

The work covered by this section consists of furnishing all labor, materials and equipment, and performing all work required for the prevention of environmental pollution and the handling, removal, transportation and disposal of any hazardous and/or regulated solid waste generated during and as the result of construction operations under this contract except for those measures set forth in other provisions of these specifications. For the purpose of this specification, environmental pollution is defined as the presence of chemical, physical, or biological elements or agents which adversely affect human health or welfare; unfavorably alter ecological balances of importance to man; or degrade the utility of the environment for esthetic and recreational purposes. The control of environmental pollution requires consideration of air, water, and land, and involves noise, solid waste-management, management of radiant energy and radioactive materials, as well as other pollutants including hazardous wastes, materials, substances and chemicals.

1.2 REFERENCES

The publications listed below form a part of this specification to the extent referenced. The publications are referred to within the text by the basic designation only.

LOUISIANA ADMINISTRATIVE CODE (LAC)

LAC 33:V Environmental Quality: Hazardous Waste and Hazardous Materials

LAC 33: VII Environmental Quality: Solid Waste

U.S. NATIONAL ARCHIVES AND RECORDS ADMINISTRATION (NARA)

29 CFR 1910.106 Flammable and Combustible Liquids

29 CFR 1910.120 Hazardous Waste Operations and Emergency Response

29 CFR 1910.1200 Hazard Communications

33 CFR 153.203 Procedures for the Notice of Discharge

40 CFR 260 Hazardous Waste Management Systems: General

40 CFR 261 Identification and Listing of Hazardous Waste

40 CFR 262 Standards Applicable to Generators of Hazardous Waste

Franklin Canal Pump Station

40 CFR 268	Land Disposal Restrictions
40 CFR 279	Standards for the Management of Used Oil
40 CFR 355	Emergency Planning and Notification
40 CFR 372-SUBPART D	Specific Toxic Chemical Listings
49 CFR 171	General Information, Regulations, and Definitions
49 CFR 171 - 178	Hazardous Materials Regulations

U.S. ARMY CORPS OF ENGINEERS (USACE)

EM 385-1-1	(2003) Safety -- Safety and Health Requirements
------------	---

1.3 MEASUREMENT AND PAYMENT

1.3.1 Environment Protection

No separate measurement or payment will be made for environment protection, including protection of fish and wildlife. Payment for the work covered under this section shall be distributed throughout the existing bid items.

1.3.2 Hazardous/Regulated Waste

(a) If the CONTRACTOR generates hazardous and/or regulated solid wastes through his/her actions, no separate measurement or payment will be made for handling, removal, transportation and disposal of hazardous and/or regulated solid wastes. Payment for the work associated with and the disposal of hazardous/regulated solid waste generated by the CONTRACTOR shall be distributed throughout the existing bid items.

(b) If the CONTRACTOR uncovers an existing hazardous/regulated waste not CONTRACTOR generated, not shown on the drawings, and not specified herein, the CONTRACTOR shall notify ENGINEER's Representative immediately. Payment for handling, removal, transportation and disposal of hazardous and/or regulated solid wastes CONTRACTOR generated, not shown on the drawings, and not specified herein will be made as an equitable adjustment in contract price under Sections GP-42 and GP-43.

1.4 SUBMITTALS

ENGINEER approval is required for submittals with an "E" designation; submittals not having an "E" designation are for information only.

SUBMITTAL PROCEDURES:

SD-01 Preconstruction Submittals

Environmental Protection Plan; E

1.5 APPLICABLE REGULATIONS

Franklin Canal Pump Station

In order to prevent, and to provide for abatement and control of any environmental pollution arising from construction activities in the performance of this contract, the CONTRACTOR shall comply with the Louisiana Pollution Discharge Elimination System (LPDES) General Permit requirements as specified in Section 01 57 23.00 12 STORM WATER POLLUTION PREVENTION PLAN, all applicable Federal, State, and Local laws, and regulations as well as USACE regulations concerning environmental pollution control and abatement and any regulations referred to in the following paragraphs. For hazardous wastes, materials, substances and chemicals applicable regulations shall include, but are not limited to, 29 CFR 1910.106, 29 CFR 1910.1200, 40 CFR 260, 40 CFR 279, 40 CFR 355, 40 CFR 372-SUBPART D, 49 CFR 171 - 178 and EM 385-1-1, LAC 33:V, and LAC 33:VII.

1.6 QUALITY CONTROL

1.6.1 General

The CONTRACTOR shall establish and maintain quality control for environmental protection to assure compliance with contract specifications and maintain records of his quality control for all construction operations including but not limited to the following:

(1) Submit plan of Environment Pollution Control. CONTRACTOR work activities (such as use of heavy equipment, fuel spill, noise, etc.) that will involve bringing hazardous chemicals, hazardous substances or hazardous materials onto the project site; include in the plan a Hazard Communication Program and Safe Storage Plan. For CONTRACTOR activities that anticipate generation of hazardous wastes at the project site, include in the plan a waste identification / determination and waste disposal plan. On-site activities that pose a risk of an oil or hazardous substance spill include in the plan a Spill Reporting and Response Plan.

(2) Procure applicable Federal, State, and Local regulations on pollution control.

(3) Air Pollution - Checks made on dust, smoke, and noise.

(4) Water Pollution - Checks made on disposal of water, oil, etc.

(5) Land Pollution - Checks made on disposal of debris, restoration of temporary construction sites, etc.

1.6.2 Reporting

The original and two copies of these records, as well as the records of corrective action taken, shall be furnished to the ENGINEER daily. CONTRACTOR to submit form to ENGINEER prior to beginning field activities.

1.7 NOTIFICATION

The ENGINEER will notify the CONTRACTOR in writing of any non-compliance with the foregoing provisions and the action to be taken. The CONTRACTOR shall, after receipt of such notice, immediately take corrective action. Such notice, when delivered to the CONTRACTOR or his authorized representative at the site of the work, shall be deemed sufficient for the

Franklin Canal Pump Station

purpose. If the CONTRACTOR fails or refuses to comply promptly, the ENGINEER may issue an order stopping all or part of the work until satisfactory corrective action has been taken. The CONTRACTOR shall make no part of the time lost due to any such stop orders the subject of a claim for extension of time or for excess cost of damages.

1.8 IMPLEMENTATION

Within 10 days after receipt of Notice of Award, or otherwise directed below, the CONTRACTOR shall:

(1) Submit in writing his/her proposals for implementing environmental pollution control at the project site, disposal of debris, non-hazardous wastes and hazardous wastes generated at the project site as well as storage and management of regulated materials, substances and chemicals brought onto and used at the project site.

(2) Meet with representatives of the ENGINEER to develop mutual understanding relative to compliance with this provision and administration of the environmental pollution control program.

(3) If applicable, submit a plan for the handling, removal, transportation and disposal of hazardous and/or regulated solid wastes generated because of the CONTRACTOR's operation.

1.8.1 Environmental Assessment of Contract Deviations

The CONTRACTOR is advised that deviations from the drawings or specifications (e.g., proposed alternate borrow areas, disposal areas, staging areas, alternate access routes, etc.) could result in the requirement for the ENGINEER to reanalyze the project from an environmental standpoint. Deviations from the construction methods and procedures indicated by the plans and specifications, which may have an environmental impact, will require an extended review, processing, and approval time by the ENGINEER. The ENGINEER reserves the right to disapprove alternate methods, even if they are more cost effective, if the ENGINEER determines that the proposed alternate method will have an adverse environmental impact.

PART 2 PRODUCTS (NOT USED)

PART 3 EXECUTION

3.1 PROTECTION OF LAND RESOURCES

3.1.1 General

The land resources within the project boundaries and outside the limits of permanent work performed under this contract shall be preserved in their present condition or be restored to a condition after completion of construction that will appear to be natural and not detract from the appearance of the project. The CONTRACTOR shall confine his/her construction activities to areas defined by the plans or specifications.

3.1.2 Prevention of Landscape Defacement

Franklin Canal Pump Station

The CONTRACTOR shall not deface, injure, or destroy trees or shrubs, nor remove or cut them without the approval of the ENGINEER. Felling of trees shall be performed in such a manner as to avoid damage to trees to be left standing. Where trees may possibly be defaced, bruised, injured, or otherwise damaged by the CONTRACTOR's operations or equipment; he shall protect adequately such trees. Earth that is displaced into uncleared areas shall be removed. All monuments and markers shall be protected before beginning operations near them. Any trees or other landscape feature scarred or damaged by the CONTRACTOR's equipment or operations shall be restored as nearly as possible to its original condition at the CONTRACTOR's expense. Trees that are scarred shall be immediately painted with acceptable tree wound paint. Any trees that are damaged beyond restoration shall be removed and disposed of at no direct pay.

3.1.3 Temporary Excavation and Embankments

If the CONTRACTOR proposes to construct temporary roads or embankments and excavation for plant and/or work areas, he shall obtain approval of the ENGINEER prior to start of such temporary work.

3.1.4 Post-Construction Cleanup or Obliteration

The CONTRACTOR shall obliterate all signs of temporary construction facilities such as haul roads, work areas, structures, foundations of temporary structures, and stockpiles of excess or waste materials upon completion of construction. The CONTRACTOR will be required to restore the construction area to near natural conditions that will permit the growth of vegetation.

3.1.5 Recording and Preserving Historical and Archeological Finds

All items having any apparent historical or archeological interest that are discovered in the course of any construction activities shall be carefully preserved. The CONTRACTOR shall leave the archeological find undisturbed and shall immediately report the find to the ENGINEER so that the proper authorities may be notified.

3.2 PROTECTION OF WATER RESOURCES

3.2.1 Contamination of Water

The CONTRACTOR shall not pollute lakes, ditches, rivers, bayous, canals, groundwater, waterways, or reservoirs with fuels, oils, bitumen, calcium chloride, insecticides, herbicides, or other similar materials harmful to fish, shellfish, or wildlife, or materials which may be a detriment to outdoor recreation.

3.2.2 Disposal of Materials

The methods and locations of disposal of materials, wastes, effluents, trash, garbage, oil, grease, chemicals, etc., within the right-of-way limits shall be such that harmful debris will not enter lakes, ditches, rivers, bayous, canals, groundwater, waterways, or reservoirs by erosion, and thus prevent the use of the area for recreation or present a hazard to wildlife.

3.2.3 Erosion Control

Surface drainage from cuts and fills within the construction limits, whether or not completed, and from borrow and waste disposal areas, shall, if turbidity producing materials are present, be held in suitable sedimentation ponds or shall be graded to control erosion within acceptable limits. Temporary erosion and sediment control measures as specified in Section 01 57 23.00 12 STORM WATER POLLUTION PREVENTION MEASURES, shall be provided and maintained until permanent drainage and erosion control facilities are completed and operative. The area of bare soil exposed at any one time by construction operations shall not exceed that necessary to perform the work.

3.3 PROTECTION OF FISH AND WILDLIFE

The CONTRACTOR shall at all times perform all work and take such steps required to prevent any interference or disturbance to fish and wildlife. The CONTRACTOR will not be permitted to alter water flows or otherwise disturb native habitat adjacent to the project area that are critical to fish or wildlife, other than as shown in the Plans.

3.4 JANITOR SERVICES

The CONTRACTOR shall furnish daily janitorial services for all the offices, shops, laboratories, or other buildings being used by the CONTRACTOR or ENGINEER employees, whether existing or CONTRACTOR furnished, and performs any required maintenance of the facilities and grounds during the life of the contract. Toilet facilities shall be kept clean and sanitary at all times. Services shall be performed at such a time and in such a manner to least interfere with the operations but will be accomplished only when the buildings are in daily use. Services shall be accomplished to the satisfaction of the ENGINEER. The CONTRACTOR shall also provide daily trash collection and cleanup of the buildings and adjacent outside areas, snow removal as required, and shall dispose of all discarded debris, aggregate samples and concrete test samples in a manner approved by the ENGINEER.

3.5 DISPOSAL OF HAZARDOUS AND/OR REGULATED SOLID WASTES

If any hazardous or regulated solid wastes will be generated as a result of the CONTRACTOR's operations, the CONTRACTOR shall submit a plan that details the proper handling, removal, transportation and disposal of such wastes. The plan shall identify what types of hazardous and/or regulated solid wastes will be generated and shall list the hazards involved with each waste. All waste generated on-site by the CONTRACTOR must be properly identified within 30 days of generation. No regulated wastes shall be allowed to accumulate on-site for more than 90 days. Regulated solid wastes are those listed in the LAC 33: VII. The plan shall include Material Safety Data Sheets (MSDS), if applicable, for all wastes expected to be generated. The plan shall include, but not be limited to the following:

(a) Hazardous waste shall be placed in closed containers and shall be shielded adequately to prevent dispersion of the waste by wind or water. Any evidence of improper storage shall be cause for immediate shutdown of the project until corrective action is taken.

(b) Nonhazardous waste shall be stored in containers separate from hazardous waste storage areas.

Franklin Canal Pump Station

(c) All hazardous waste shall be transported by a licensed transporter in accordance with LAC 33: V and 49 CFR 171, Subchapter C.

(d) All nonhazardous waste shall be transported in accordance with local regulations regarding waste transportation.

(e) In addition to the number of manifest copies required by LAC 33:V, one copy of each manifest will be supplied to the ENGINEER prior to transportation.

(f) The plan shall identify what types of hazardous and/or regulated solid wastes will be generated and shall list the hazards involved with each waste.

3.5.1 Hazardous Wastes

For the handling, removal, transportation and disposal of any generated hazardous wastes, the plan shall conform to the requirements of 40 CFR 260, 49 CFR 171 - 178 as well as other applicable Federal, State and Local regulations. All employees of the CONTRACTOR that will be directly involved in the handling and/or removal of hazardous wastes shall be trained in accordance with 29 CFR 1910.120. In addition, the employees shall have undergone a medical evaluation in accordance with 29 CFR 1910.120. The CONTRACTOR shall include copies of employees' certifications and medical examinations as part of the plan specified herein. The plan shall also address the proper Personnel Protective Equipment (PPE) that the employees will be required to wear during the handling and removal of hazardous wastes. The CONTRACTOR shall obtain an EPA ID# and Hazardous Waste Disposal Manifests and shall sign the manifests as the generator. Wastes shall be transported via state and Federal approved hazardous waste transporter and disposed of at a state and Federal approved temporary, storage and disposal (TSD) facility. Copies of licenses and certifications of the transporter and TSD shall be included in the plan. The plan shall list the name and address of each transporter and TSD to be utilized. The CONTRACTOR shall be responsible for any sampling and analysis required by the TSD for characterization purposes. The CONTRACTOR shall submit to the ENGINEER completed copies of all Hazardous Waste Disposal Manifests within five (5) days after ultimate disposal at the TSD. Other regulations applicable to the handling, removal, transportation and disposal of hazardous wastes are: 40 CFR 261; 40 CFR 262; 40 CFR 268; and LAC 33:V.

3.5.2 Regulated Solid Wastes

For the handling, removal, transportation and disposal of any generated regulated solid wastes, the plan shall conform to the requirements of LAC 33:VII. Solid wastes shall be transported to a Federal and state approved TSD, oil recycler or Industrial Type I Landfill. The CONTRACTOR shall identify in the plan how he/she intends to dispose of each solid waste. The plan shall include the name, address, licenses and certifications of each disposal facility that will be used. If disposal manifests are required, the CONTRACTOR shall sign them as the generator. The CONTRACTOR shall be responsible for any sampling and analyses that may be required by the disposal facility(ies) for characterization purposes. Licenses and certifications of the transporter and disposal facilities shall be included in the plan. The CONTRACTOR shall submit to the ENGINEER a completed copy of any waste disposal manifests within five (5) days after ultimate disposal.

3.5.3 Laboratory Accreditation

All laboratory testing for waste determinations shall be performed by a laboratory which has received accreditation from status with the Louisiana Department of Environmental Quality (LDEQ) laboratory certification program.

3.6 MAINTENANCE OF POLLUTION CONTROL FACILITIES

During the life of this contract the CONTRACTOR shall maintain all facilities constructed for pollution control under this contract as long as the operations creating the particular pollutant are being carried out or until the material concerned has become stabilized to the extent that pollution is no longer being created. Early in the construction period the CONTRACTOR shall conduct a training course that will emphasize all phases of environmental protection.

3.7 REPORTING OF POLLUTION SPILLS

In the event that an oil spill or chemical release occurs during the performance of this contract, the CONTRACTOR is required to contact the National Response Center, telephone number 1-800-424-8802 as soon as possible, or if telephone communication is not possible, the nearest U.S. Coast Guard office may be contacted by radio to report the spill, (33 CFR 153.203). The CONTRACTOR shall comply with any instructions from the responding agency concerning containment and/or cleanup of the spill.

-- End of Section --

SECTION 01 57 23.00 12
STORMWATER POLLUTION PREVENTION MEASURES

INDEX

SECTION 01 57 23.00 12 - STORM WATER POLLUTION PREVENTION MEASURES

PART 1 GENERAL..... 2

1.1 SCOPE2

1.2 REFERENCES2

1.3 MEASUREMENT AND PAYMENT3

1.3.1 SWPPP3

1.3.2 Silt Fence3

1.4 SUBMITTALS3

1.5 DEFINITIONS3

1.6 GENERAL3

1.6.1 Environmental Assessment of Contract Deviations4

1.6.2 Notice Of Intent4

1.7 RECORD RETENTION REQUIREMENTS4

1.7.1 Documents4

1.7.2 Plan Accessibility4

1.7.3 LDEQ Correspondence5

1.8 MAINTENANCE AND SURVEILLANCE FEES5

1.9 EROSION AND SEDIMENT CONTROLS5

1.9.1 Stabilization Controls5

1.9.1.1 Unsuitable Conditions5

1.9.1.2 No Activity for Less Than 21 Days5

1.9.2 Structural Controls6

1.9.2.1 Silt Fence Barrier6

PART 2 PRODUCTS..... 6

2.1 COMPONENTS FOR SILT FENCE BARRIER6

2.1.1 Geotextile6

2.1.2 Wooden Posts and Steel T-Posts6

2.1.3 Identification Storage and Handling7

PART 3 EXECUTION..... 7

3.1 INSTALLATION OF SILT FENCE BARRIER7

3.2 MAINTENANCE7

3.2.1 Silt Fence Barrier Maintenance7

3.3 INSPECTIONS7

3.3.1 General7

3.3.2 Inspections Details8

3.3.3 Inspection Reports8

3.4 NOTICE OF TERMINATION8

3.5 COMPLETION REPORT8

SECTION 01 57 23.00 12

STORM WATER POLLUTION PREVENTION MEASURES

PART 1 GENERAL

1.1 SCOPE

The work specified in this section consists of the CONTRACTOR implementing, and diligently pursuing all measures required in the Storm Water Pollution Prevention Plan (SWPPP). The SWPPP consists of this Section, 01 57 23.00 12, and any and all references and attachments including existing and future signed certification statements. The purpose of the SWPPP is to control soil erosion and the resulting sediment to the extent necessary to prevent sediment from leaving the contract rights-of-way and prevent pollution of any water body caused by the runoff from the areas of construction activities under this contract, under the terms of PERMIT NO. LAR100000, and as specified herein and shown on the drawings. The requirements of these specifications are supplemental to and shall become part of the overall Environmental Protection Plan required by Section 01 57 20.00 12 ENVIRONMENTAL PROTECTION. The CONTRACTOR shall prepare and review the SWPPP to determine requirements for compliance. In addition, the CONTRACTOR shall ascertain that he has reviewed the plan, and that they comply with its provisions.

1.2 REFERENCES

The publications listed below form a part of this specification to the extent referenced. The publications are referred to in the text by basic designation only.

ASTM INTERNATIONAL (ASTM)

- | | |
|-------------|--|
| ASTM D 4491 | (1999; R 2009) Water Permeability of Geotextiles by Permittivity |
| ASTM D 4632 | (2008) Standard Test Method for Grab Breaking Load and Elongation of Geotextiles |
| ASTM D 4751 | (2004) Determining Apparent Opening Size of a Geotextile |
| ASTM D 4833 | (2007) Index Puncture Resistance of Geotextiles, Geomembranes, and Related Products |
| ASTM D 4873 | (2002; R 2009) Identification, Storage, and Handling of Geosynthetic Rolls and Samples |

LOUISIANA DEPARTMENT OF ENVIRONMENTAL QUALITY (LDEQ)

- | | |
|----------------------|---|
| PERMIT NO. LAR100000 | (2004) Storm Water General Permit for Construction Activities, Five (5) Acres or More |
|----------------------|---|

Franklin Canal Pump Station

PERMIT NO. LAR200000

(2003) Storm Water General Permit for Small
Construction Activities

1.3 MEASUREMENT AND PAYMENT

1.3.1 SWPPP

No separate measurement or payment will be made for work required by this section, except as specified in paragraph[s] Silt Fence for SWPPP. Price and payment shall be distributed amongst the existing items.

1.3.2 Silt Fence

Measurement for silt fences satisfactorily placed will be made by the linear foot. Payment for silt fences as specified herein will be made at the contract linear foot price for Bid Item "Temporary Silt Fencing." The amount of 50% of the contract price will be paid to CONTRACTOR upon completion of the silt fencing. An amount of 20% will be paid to CONTRACTOR in two increments spaced evenly throughout the remainder of construction with 10% to be withheld until the completion of the construction contract.

1.4 SUBMITTALS

Notice of Intent

Inspection Reports

Notice of Termination

Completion Report

1.5 DEFINITIONS

a. Construction OWNER - The construction OWNER is the party that has operational control over plans and specifications including the ability to make changes to those items. CPRA is the construction OWNER.

b. Construction Operators - The construction operators are the party having control over the plans and specifications and the party having day-to-day operational control over those activities at a project site which are necessary to ensure compliance with the SWPPP or other permit conditions. The CONTRACTOR is the construction operator.

c. Notice of Intent (NOI) - A document that is completed and submitted to the Louisiana Department of Environmental Quality as application for coverage to discharge under the PERMIT NO. LAR100000.

d. Notice of Termination (NOT) - A document that is completed and submitted to the Louisiana Department of Environmental Quality to terminate permission to discharge under the PERMIT NO. LAR100000. The NOT must be filed within 30 days after final stabilization of the construction site has been achieved or the CONTRACTOR is no longer the construction operator.

1.6 GENERAL

Franklin Canal Pump Station

The CONTRACTOR shall implement the Storm Water Pollution Prevention Plan (SWPPP) specified in a manner which will meet the requirements of Section 01 57 23.00 12 ENVIRONMENTAL PROTECTION, and the requirements of the Louisiana Pollution Discharge Elimination System (LPDES) permit, PERMIT NO. LAR100000 effective October 1, 2004.

1.6.1 Environmental Assessment of Contract Deviations

The CONTRACTOR is advised that deviations from the SWPPP could result in the requirement for the ENGINEER to reanalyze the project from an environmental standpoint. Deviations from the SWPPP erosion control requirements as specified herein and as shown on the drawings which may have an environmental impact will require an extended review, processing, and approval time by the ENGINEER.

1.6.2 Notice Of Intent

Upon CONTRACTOR'S preparation of a complete SWPPP, the NOI will be submitted by the CONTRACTOR to the LDEQ under the terms of PERMIT NO. LAR100000. Prior to initiating any construction activities, if a specific LPDES permit applicable to this construction item has been received from the LDEQ in response to the NOI, a copy of the specific LPDES permit will also be provided to the ENGINEER. Certified mail is recommended for CONTRACTOR'S proof of submittal. A copy of the CONTRACTOR'S NOI submittal shall be provided to the ENGINEER'S representative at the time of submittal. The NOI as well as the specific permits in response to the NOI, shall be posted at the job site by the CONTRACTOR. (Forms are attached at the end of this Section.)

1.7 RECORD RETENTION REQUIREMENTS

1.7.1 Documents

The CONTRACTOR shall retain copies of the SWPPP and all reports required by the general permit, and all records of data used to complete the NOI, for a period of at least three years from the date that the construction site is finally stabilized. Records of the NOI as well as any data used to complete it, the SWPPP, and any reports required by PERMIT NO. LAR100000 shall be retained by the permittee for at least three years from the date that the site is finally stabilized.

1.7.2 Plan Accessibility

A copy of the SWPPP and a copy of all permits received, shall be retained at the construction site (or other local location accessible to the State Administration Authority and the public) from the date of construction initiation to the date of final stabilization. The CONTRACTOR shall have a copy of the plan available at a central location on-site for the use of all operators and those identified as having responsibilities under the plan whenever they are on the construction site. A notice shall be posted near the main entrance to the construction site with the following information: (1) the LPDES permit number for the project or a copy of the NOI if a permit has not yet been assigned; (2) the name and telephone number of a local contact person; (3) a brief description of the project; and (4) the location of the SWPPP if the site is inactive or does not have an on-site location to store the plan.

Franklin Canal Pump Station

1.7.3 LDEQ Correspondence

Any written correspondence with the LDEQ concerning the NOI, NOT, SWPPP, or discharges from any facility covered under PERMIT NO. LAR100000 shall be identified by permit number, if one has been assigned, and sent to the address below:

Louisiana Department of Environmental Quality
Office of Environmental Services
P.O. Box 4313
Baton Rouge, LA 70821-4313

Attn: Permits Division

1.8 MAINTENANCE AND SURVEILLANCE FEES

The CONTRACTOR shall, without additional expense to the OWNER, be responsible for paying any state required annual maintenance and surveillance fee for work associated with coverage under PERMIT NO. LAR100000.

1.9 EROSION AND SEDIMENT CONTROLS

The controls and measures required for controlling sediment during construction are described below.

1.9.1 Stabilization Controls

The stabilization practices to be implemented shall include fertilizing and seeding as specified in Section 32 92 19.00 12 FERTILIZING AND SEEDING or any other temporary measure to restrict erosion from the construction site. On the daily Report, the CONTRACTOR shall record the dates when the major grading activities occur; when construction activities temporarily or permanently cease on a portion of the site; and when stabilization practices are initiated. Except as provided in paragraphs "Unsuitable Conditions" and "No Activity for Less Than 21 Days," stabilization practices shall be initiated as soon as practicable, but no more than 14 days, in any portion of the site where construction activities have temporarily or permanently ceased.

1.9.1.1 Unsuitable Conditions

Where the initiation of stabilization measures by the fourteenth day after construction activity temporarily or permanently ceases is precluded by unsuitable conditions caused by the weather, stabilization practices shall be initiated as soon as practicable after conditions become suitable.

1.9.1.2 No Activity for Less Than 21 Days

Where construction activity will resume on a portion of the site within 21 days from when activities ceased (e.g., the total time period that construction activity is temporarily ceased is less than 21 days), then stabilization practices do not have to be initiated on that portion of the site by the fourteenth day after construction activity temporarily ceased. Stabilization practices shall be initiated on that portion of the site by the fourteenth day in the case where construction activities will not resume within 21 days after construction activities have ceased.

1.9.2 Structural Controls

Structural practices shall be implemented to divert flows from exposed soils, temporarily store flows, or otherwise limit runoff and the discharge of pollutants from exposed areas of the site. Structural practices shall be implemented in a timely manner during the construction process to minimize erosion and sediment runoff.

1.9.2.1 Silt Fence Barrier

The CONTRACTOR shall provide silt fences as a temporary structural practice to minimize erosion and sediment runoff. Silt fences shall be properly installed, as shown on the contract drawings, to effectively retain sediment immediately after completing each phase of work where erosion would occur in the form of sheet and rill erosion (e.g. clearing and grubbing, excavation, embankment, and grading). Silt fences shall be installed in the locations indicated on the drawings. Final removal of silt fence barriers shall be upon approval by the ENGINEER.

PART 2 PRODUCTS

2.1 COMPONENTS FOR SILT FENCE BARRIER

2.1.1 Geotextile

The geotextile shall consist of polymeric filaments which are formed into a stable network such that filaments retain their relative positions. The filament shall consist of a long-chain synthetic polymer composed of at least 85 percent by weight of ester, propylene, or amide, and shall contain stabilizers and/or inhibitors added to the base plastic to make the filaments resistant to deterioration due to ultraviolet and heat exposure. Geotextile shall contain ultraviolet ray inhibitors and stabilizers to provide a minimum of six months of expected usable construction life at a temperature range of 0 to 120 degrees F. The geotextile shall meet the following requirements:

GEOTEXTILE FOR SILT FENCE

<u>PROPERTY</u>	<u>TEST PROCEDURE</u>	<u>VALUE</u>
Grab Breaking Load, pounds	ASTM D 4632	200 minimum
Grab Elongation at Ultimate, percent	ASTM D 4632	20 maximum
Puncture Strength, pounds	ASTM D 4833	130 minimum
AOS, U.S. Standard Sieve No.	ASTM D 4751	30 - 70
Permittivity, per second	ASTM D 4491	0.25 minimum

2.1.2 Wooden Posts and Steel T-Posts

The CONTRACTOR may use either rounded wooden posts or steel T-posts for silt fence construction. Wooden posts utilized for silt fence construction, shall have a minimum 3-1/2 inch diameter, and shall have a minimum length of 7 feet, and shall be either oak or pine wood. Steel T-posts utilized for silt fence construction, shall have a minimum weight of 1.33 pounds per linear foot and a minimum length of 7 feet.

Franklin Canal Pump Station

2.1.3 Identification Storage and Handling

Geotextile shall be identified, stored and handled in accordance with ASTM D 4873.

PART 3 EXECUTION

3.1 INSTALLATION OF SILT FENCE BARRIER

The silt fence shall be located and installed as indicated on the contract drawings. Geotextile shall be from a continuous roll cut to the length of the barrier to avoid the use of joints. When joints are unavoidable, geotextile shall be spliced together at a support post, with a minimum 6-inch overlap, and securely sealed. A trench shall be excavated approximately 4 inches wide and 4 inches deep on the upslope side of the location of the silt fence. The 4-inch by 4-inch trench shall be backfilled and the soil compacted over the geotextile. The geotextile shall be attached to the land side of the post with wire or other method recommended by the manufacturer and such that a 6-inch length of geotextile is left unattached at the bottom of the post, the unattached geotextile embedded in the trench and the trench backfilled. It is the responsibility of the CONTRACTOR to maintain the integrity of the silt fence. The CONTRACTOR shall immediately correct any deficiencies. The silt fence shall be promptly repaired or replaced should it become damaged or otherwise ineffective. The silt fence is to remain in place upon completion of the project, or as directed by the ENGINEER. Its maintenance shall be continual for that period of time for which excavated materials are placed in the area of the silt fence.

3.2 MAINTENANCE

The CONTRACTOR shall maintain the temporary and permanent vegetation, erosion and sediment control measures, and other protective measures in good and effective operating condition by performing routine inspections to determine condition and effectiveness, by restoration of destroyed vegetative cover, and by repair of erosion and sediment control measures and other protective measures. The following procedures shall be followed to maintain the protective measures.

3.2.1 Silt Fence Barrier Maintenance

Silt fences shall be inspected in accordance with paragraph "INSPECTIONS." Any required repairs shall be made promptly. Close attention shall be paid to the repair of damaged silt fence resulting from end runs and undercutting. Should the geotextile on a silt fence decompose or become ineffective, and the barrier is still necessary, the geotextile shall be replaced promptly. Sediment deposits shall be removed when deposits reach one-third of the height of the barrier. Sediments shall be utilized in the job or disposed of as construction debris. The immediate area occupied by the fence and any sediment deposits shall be shaped to an acceptable grade.

3.3 INSPECTIONS

3.3.1 General

The CONTRACTOR shall inspect disturbed areas of the construction site, areas used for storage of materials that are exposed to precipitation that have not been finally stabilized, stabilization practices, structural practices,

Franklin Canal Pump Station

other controls, and area where vehicles exit the site at least once every fourteen (14) calendar days, before anticipated storm events (or series of storm events such as intermittent showers over one or more days) expected to cause a significant amount of runoff, and within 24 hours of the end of any storm that produces 0.5 inches or more rainfall at the site. Where sites have been finally stabilized, such inspection shall be conducted at least once every two weeks.

3.3.2 Inspections Details

Disturbed areas and areas used for material storage that are exposed to precipitation shall be inspected for evidence of, or the potential for, pollutants entering the drainage system. Erosion and sediment control measures identified in the SWPPP shall be observed to ensure that they are operating correctly. Discharge locations or points shall be inspected to ascertain whether erosion control measures are effective in preventing significant impacts to receiving waters. Locations where vehicles exit the site shall be inspected for evidence of offsite sediment tracking.

3.3.3 Inspection Reports

For each inspection conducted, the CONTRACTOR shall prepare a report summarizing the scope of the inspection, name(s) and qualifications of personnel making the inspection, the date(s) of the inspection, major observations relating to the implementation of the SWPPP, maintenance performed, and actions taken. The report shall be submitted to the ENGINEER within 24 hours of the inspection as a part of the CONTRACTOR's daily report. A copy of the inspection report shall be maintained on the job site.

3.4 NOTICE OF TERMINATION

Upon stabilization and elimination of all storm water discharges authorized by PERMIT NO. LAR100000, or where the operator of all storm water discharges at a facility changes, a Notice of Termination (NOT) shall be certified and submitted by the CONTRACTOR to the Permits Division at the LDEQ. The NOT shall be submitted within 30 days of final stabilization of the construction site or when the CONTRACTOR is no longer the construction operator.

3.5 COMPLETION REPORT

Upon stabilization and elimination of all storm water discharges authorized by PERMIT NO. LAR200000, or where the operator of all storm water discharges at a facility changes, a Completion Report shall be certified and submitted by the CONTRACTOR to the Permits Division at the LDEQ. Certified mail is recommended for proof of the Completion Report submittal. The Completion Report shall be submitted within 30 days of final stabilization of the construction site or when the CONTRACTOR is no longer the construction operator.

Franklin Canal Pump Station

CERTIFICATION STATEMENT #1

Any person, including the construction ENGINEER/operator, signing documents (the SWPPP, modifications to the SWPPP, or other reports) under Part VI.G. of PERMIT NO. LAR100000 or PERMIT NO.LAR200000 shall make the following certification.

Franklin Canal Pump Station
LAT. = N 29°47'0.61"
LONG. = W 91°31'41.14"

CMD P20100053
MVN 2010-00265

Storm Water Pollution Prevention Plan

I certify under penalty of law that this document and all attachments were prepared under my direction or supervision in accordance with a system designed to assure that qualified personnel properly gathered and evaluated the information submitted. Based on my inquiry of the person or persons who manage this system, or those persons directly responsible for gathering the information, the information submitted is, to the best of my knowledge and belief, true, accurate, and complete. I also certify that a storm water pollution prevention plan, including both construction and post construction controls, has been prepared for the site in accordance with the permit and that such plan complies with approved State, Tribal and/or local sediment and erosion plans or permits and/or storm water management plans or permits. I am aware that signature and submittal of the Notice of Intent is deemed to constitute my determination of eligibility under one or more of the requirements of Permit Part I.A.3.e(1), related to the Endangered Species Act requirements. To the best of my knowledge, I further certify that such discharges and discharge related activities will not have an effect on properties listed or eligible for listing on the National Register of Historic Places under the National Historic Preservation Act, or are otherwise eligible for coverage under Part I.A.3.f of the permit. I am also aware that there are significant penalties for submitting false information, including the possibility of fine and imprisonment for knowing violations.

Signature _____
Printed Name _____
Title _____
Company _____
Date _____
Telephone _____

Franklin Canal Pump Station

CERTIFICATION STATEMENT #2

Any CONTRACTOR implementing any part of this plan must prepare and sign a copy of the following certification.

Franklin Canal Pump Station
LAT. = N 29°47'0.61"
LONG. = W 91°31'41.14"

CMD P20100053
MVN 2010-00265

I certify, under penalty of law, that I understand the terms and conditions of the Louisiana Pollutant Discharge Elimination System (LPDES) general permit that authorizes storm water discharges associated with construction activity from the construction site identified as part of this certification.

Firm Name: _____

Address: _____

_____ Telephone No: _____

Signature: _____ Title: _____

Date: _____

Franklin Canal Pump Station

CERTIFICATION STATEMENT #3

Any CONTRACTOR that will conduct activities that may impact the effectiveness of the SWPPP control measures must prepare and sign the following certification.

Franklin Canal Pump Station
LAT. = N 29°47'0.61"
LONG. = W 91°31'41.14"

CMD P20100053
MVN 2010-00265

I certify, under penalty of law, that I will coordinate, through the CONTRACTOR, OWNER, or directly, with the CONTRACTOR (s) identified in the pollution prevention plan having responsibility for implementing storm water control measures to minimize any impact my actions may have on the effectiveness of these storm water control measures.

Firm Name: _____

Address: _____

_____ Telephone No: _____

Signature: _____ Title: _____

Date: _____

-- End of Section --

DIVISION 03
CONCRETE

SECTION 03 41 17
PRECAST CONCRETE PLATFORMS

INDEX

SECTION 03 41 17 - PRECAST CONCRETE PLATFORMS

PART 1	GENERAL	3
1.1	SCOPE	3
1.1.1	Related Sections	3
1.2	REFERENCES	3
1.3	MEASUREMENT AND PAYMENT	6
1.4	SUBMITTALS	6
1.4.1	Shop Drawings	6
1.4.2	Product Data	7
1.4.3	Concrete Mix Design	7
1.4.4	Test Reports	8
1.5	SYSTEM DESCRIPTION	8
1.5.1	Design Requirements	8
1.5.1.1	ENGINEER Supplied Design	8
1.5.1.2	Design Codes	8
1.5.1.3	Loads	8
1.6	QUALITY ASSURANCE	8
1.6.1	Qualifications	8
1.6.1.1	Fabricator Qualifications	8
1.6.1.2	Erector Qualifications	9
1.6.1.3	Designer Qualifications	9
1.7	DELIVERY, STORAGE, AND HANDLING	9
PART 2	PRODUCTS	9
2.1	MATERIALS	9
2.1.1	Form Materials	9
2.1.2	Reinforcing Materials	9
2.1.3	Concrete Materials	10
2.1.4	Chemical Admixtures	10
2.1.5	Steel Connection Materials	11
2.1.6	Grout Materials	11
2.1.6.1	Repair of Surface Defects	11
2.1.6.2	Repair of minor spalling (when approved by ENGINEER)	12
2.1.7	Sealant Materials	12
2.1.8	Misc. Materials	12
2.2	CONCRETE MIXTURES	12
2.3	FORM FABRICATION	13
2.4	PRODUCTION QUALITY CONTROL PROCEDURES	13
2.5	FABRICATION	13
2.5.1	Cast-in Anchors, Inserts, Plates, Angles, and Other	13
2.5.2	Reinforcement	13
2.5.3	Concrete Placement	14
2.5.4	Surface Finishes	14
2.5.4.1	Slab Surfaces	14
2.5.4.1.1	Surfaces subject to Pedestrian Traffic	14
2.5.4.1.2	Surfaces to receive Cast-In-Place Topping	14
2.5.4.2	Formed Surfaces:	14
2.5.4.2.1	PCI Standard Grade unless otherwise specified	14
2.5.5	Concrete Curing	14
2.5.6	Acceptance/Correction/Rejection of Defects	14
2.5.6.1	Minor Defects	14
2.5.6.2	Major Defects	15
2.6	TESTS, INSPECTIONS, AND VERIFICATIONS	15
2.6.1	Factory Inspection	15
PART 3	EXECUTION	15
3.1	PREPARATION	15

- 3.2 EXAMINATION15
- 3.3 ERECTION15
- 3.4 ERECTION TOLERANCES17
 - 3.4.1 Specific Tolerances17
 - 3.4.1.1 Platform Panels17
 - 3.4.1.1.1 Horizontal Location17
 - 3.4.1.1.2 Elevation17
 - 3.4.1.1.3 Level Perpendicular to Cap17
 - 3.4.1.1.4 Level Parallel to Cap17
 - 3.4.1.2 Slab Joints Longitudinal17
 - 3.4.1.3 Slab Joints Transverse17
 - 3.4.1.4 Install per plan details and manufacturers recommendations.17
- 3.5 JOINT SEALING17
- 3.6 REPAIRS17
- 3.7 CLEANING18

SECTION 03 41 17
PRECAST CONCRETE PLATFORMS

PART 1 GENERAL

1.1 SCOPE

This section includes performance criteria, materials, design, production, and erection of precast concrete platforms, solid match-cast concrete slabs, and precast columns as shown on the Contract Drawings. The work performed under this Section includes all labor, material, equipment, related services, and supervision required for the manufacture and erection of the structural precast concrete work shown on the Contract Drawings.

1.1.1 Related Sections

Contract Drawings and General Provisions of the Contract, General and Supplementary Conditions, and Division 01 Specification Sections.

Section 31 62 13.20: Precast Prestressed Concrete Piles

1.2 REFERENCES

Publications listed form a part of this specification to the extent referenced, most recent edition unless otherwise noted.

ACI INTERNATIONAL (ACI)

ACI 304R	Guide for Measuring, Mixing, Transporting, and Placing Concrete
ACI 305R	Specification for Hot Weather Concreting
ACI 306.1	Standard Specification for Cold Weather Concreting
ACI 309R	Guide for Consolidation of Concrete
ACI 318	Building Code Requirements for Structural Concrete and Commentary

AMERICAN ASSOCIATION OF STATE HIGHWAY AND TRANSPORTATION OFFICIALS(AASHTO)

AASHTO HB-17	Standard Specifications for Highway Bridges 17th Edition
--------------	--

AMERICAN WELDING SOCIETY (AWS)

AWS D1.1/D1.1M(2010)	Structural Welding Code - Steel
AWS D1.4	Structural Welding Code - Reinforcing Steel

ASTM INTERNATIONAL (ASTM)

ASTM A 123	Standard Specification for Zinc (Hot-Dip Galvanized) Coatings on
------------	--

Iron and Steel Products

ASTM A 153	Standard Specification for Zinc Coating (Hot-Dip) on Iron and Steel Hardware
ASTM A 185	Standard Specification for Steel Welded Wire Reinforcement, Plain, for Concrete
ASTM A 27	Standard Specification for Steel Castings, Carbon, for General Application
ASTM A 307	Standard Specification for Carbon Steel Bolts and Studs, 60 000 PSI Tensile Strength
ASTM A 325	Standard Specification for Structural Bolts, Steel, Heat Treated, 120/105 ksi Minimum Tensile Strength
ASTM A 325M(2009)	Standard Specification for Structural Bolts, Steel, Heat Treated
ASTM A 36	Standard Specification for Carbon Structural Steel
ASTM A 47/A 47M(1999; R 2009)	Standard Specification for Ferritic Malleable Iron Castings
ASTM A 496	Standard Specification for Steel Wire, Deformed, for Concrete Reinforcement
ASTM A 497	Standard Specification for Steel Welded Wire Reinforcement, Deformed, for Concrete
ASTM A 563	Standard Specification for Carbon and Alloy Steel Nuts
ASTM A 615	Standard Specification for Deformed and Plain Carbon-Steel Bars for Concrete Reinforcement
ASTM A 706/A 706M(2009b)	Standard Specification for Low-Alloy Steel Deformed and Plain Bars for Concrete Reinforcement
ASTM A 767	Standard Specification for Zinc-Coated (Galvanized) Steel Bars for Concrete Reinforcement
ASTM A 775	Standard Specification for Epoxy-Coated Steel Reinforcing Bars

ASTM A 780	Standard Practice for Repair of Damaged and Uncoated Areas of Hot-Dip Galvanized Coatings
ASTM A 82	Standard Specification for Steel Wire, Plain, for Concrete Reinforcement
ASTM C 1107	Standard Specification for Packaged Dry, Hydraulic-Cement Grout (Nonshrink)
ASTM C 1202	Standard Test Method for Electrical Indication of Concrete's Ability to Resist Chloride Ion Penetration
ASTM C 1218	Standard Specification for Water-Soluble Chloride in Mortar and Concrete
ASTM C 1240	Standard Specification for Silica Fume Used in Cementitious Mixtures
ASTM C 1260	Standard Test Method for Potential Alkali Reactivity of Aggregates (Mortar-Bar Method)
ASTM C 136	Standard Test Method for Sieve Analysis of Fine and Coarse Aggregates
ASTM C 150	Standard Specification for Portland Cement
ASTM C 260	Standard Specification for Air-Entraining Admixtures for Concrete
ASTM C 311	Sampling and Testing Fly Ash or Natural Pozzolans for Use as a Mineral Admixture in Portland-Cement Concrete
ASTM C 33	Standard Specification for Concrete Aggregates
ASTM C 330	Standard Specification for Lightweight Aggregates for Structural Concrete
ASTM C 430	Fineness of Hydraulic Cement by the 45-Micrometer (No. 325) Sieve
ASTM C 494	Standard Specification for Chemical Admixtures for Concrete
ASTM C 595	Standard Specification for Blended Hydraulic Cements

ASTM C 618	Standard Specification for Coal Fly Ash and Raw or Calcined Natural Pozzolan for Use in Concrete
ASTM C 94	Standard Specification for Ready-Mixed Concrete
ASTM C 989	Standard Specification for Slag Cement for Use in Concrete and Mortars
ASTM F 436	Hardened Steel Washers
ASTM F 844	Washers, Steel, Plain (Flat), Unhardened for General Use

PRECAST/PRESTRESSED CONCRETE INSTITUTE (PCI)

PCI MNL-116	Manual for Quality Control for Plants and Production of Structural Precast Concrete Products
PCI MNL-120	PCI Design Handbook - Precast and Prestressed Concrete
PCI MNL-124	Design for Fire Resistance of Precast Prestressed Concrete

1.3 MEASUREMENT AND PAYMENT

Measurement for precast concrete platforms as shown on the drawings for Base Bid and Alternate 1 will be made as follows;

Precast Concrete Deck, 10"	Sq. Ft.
Precast Concrete Deck, 10.5"	Sq. Ft.
Precast Concrete Capsills	Each

Payment for precast concrete platforms will be made at the contract price for each respective item. Prices and payments shall constitute full compensation for furnishing all plant, labor, materials including embedments, equipment and performing the work, installation including any necessary repairs, in accordance with these specifications.

1.4 SUBMITTALS

1.4.1 Shop Drawings

Indicate complete information for the fabrication, handling, and erection of the precast member. Drawings shall not be reproductions of Contract Drawings.

Indicate, as a minimum, the following information:

Member piece marks locating and defining products furnished by the fabricator, E.

Dimensioned size and shape for each member with quantities, position and

other details of reinforcing steel, anchors, inserts and other embedded items, E.

Connections between members and connections between members and other construction, E.

Joint arrangement and treatment, E.

Location and size of openings, E.

Location, size, and details of all cast-in items, E.

Lifting and erection inserts, E.

Location of field installed anchors, E.

Erection sequences and handling requirements, E.

Relationships to adjacent material.

Surface finishes of each member, E.

Methods for storage and transportation.

Description of loose, cast-in and field hardware.

Strength properties for concrete, steel and other materials, E.

Loadings used in the design of lift details, E.

1.4.2 Product Data

Submit data sheets for following products:

Lifting inserts and devices

Rebar Splice Devices

Anchorage Devices

Bearing pads

Grouts

Sealants

Coatings

Other products included in the finished project.

1.4.3 Concrete Mix Design

Submit a mix design for each strength and type of concrete. Include history showing compression test results where available.

Include a complete list of materials including type, brand, source and amount of cement, fly ash, pozzolans, silica fume, ground slag, and admixtures.

Clearly indicate where each mix design will be used when more than one mix design is submitted.

1.4.4 Test Reports

Submit Concrete Compression Test Reports for each batch of concrete.

1.5 SYSTEM DESCRIPTION

Consists of match-cast slab sections supported on precast concrete beams, which are supported by piles of the type specified in the Contract Plans. Precast members shall be the product of a fabricator specializing in the production of precast concrete systems similar to that shown in the Contract Plans.

1.5.1 Design Requirements

1.5.1.1 ENGINEER Supplied Design

When ENGINEER's Contract Plans provide a design for the precast elements, Fabricator has no design responsibility regarding design unless noted and shall proceed directly to shop drawing preparation.

1.5.1.2 Design Codes

ACI 318

1.5.1.3 Loads

Provide structural precast concrete members and connections capable of withstanding design loads:

Dead Loads

Transportation and Handling Loads

Wind, rain, snow, seismic loads in accordance with local building codes.

Importance factors, exposure category, use group, design category, site classification and other specific parameters shall be as specified in the Contract Documents:

Project Specific Loads: Live Loads, Operating Loads, Equipment Loads, and other loads indicated within limits and under conditions indicated on Contract Drawings.

DESIGN PRECAST MEMBERS AND CONNECTIONS FOR THE CONDITIONS AND SPANS INDICATED, AND FOR ADDITIONAL LOADS IMPOSED BY OPENINGS AND SUPPORTS OF THE WORK OF OTHER TRADES. WHERE CONCRETE TOPPINGS ARE SPECIFIED THEY MAY BE USED IN ESTABLISHING THE DESIGN STRENGTH OF THE PRECAST MEMBERS.

1.6 QUALITY ASSURANCE

1.6.1 Qualifications

1.6.1.1 Fabricator Qualifications

Experienced in producing structural precast concrete units similar to those indicated for this Project and with a record of at least 5 years successful in-service performance with sufficient production capacity to produce required members without delaying the Work.

Waskey Bridges or approved equal.

1.6.1.2 Erector Qualifications

Experienced in erecting structural precast concrete units similar to those indicated for this project and with a record of at least 5 successful projects of comparable type, size, scope and configuration.

1.6.1.3 Designer Qualifications

The designer shall be a licensed Professional ENGINEER in the state where the project is located experienced in the design of precast concrete.

1.7 DELIVERY, STORAGE, AND HANDLING

CONTRACTOR is responsible for design of lift point. Deliver all structural precast concrete members in such quantities and at such times to assure compliance with the agreed upon project schedule and setting sequence to ensure continuity of installation. Obtain any size, weight, or other transportation permits necessary. Transport members in a manner to avoid excessive stresses that could cause cracking or other damage. Protect against vibration induced cracking or load shifting. Provide adequate padding material between tie chains or cables to preclude chipping or spalling of concrete. Handle members in a manner to avoid excessive stresses that could cause cracking or other damage or come into inadvertent contact with other structures or objects. Lift and support members only at the lift points indicated on the Shop Drawings. Handle only by means of devices approved for the lifting hardware shown on the Shop Drawings. Store only in prepared areas which have stable soils and adequate bearing capacity. Provide suitable foundations to prevent differential settlement or twisting of members. Store units with adequate dunnage and bracing to prevent contact with soil, staining, and to control cracking, distortion, warping or other physical damage. Store members with dunnage of uniform dunnage thickness across full width of each lift point unless otherwise noted on the Shop Drawings. Arrange dunnage in vertical planes when stacking. Do not use upper members of a stacked tier as storage areas for shorter or longer members or equipment. Place stored members so identification marks are clearly visible, and units can be inspected.

PART 2 PRODUCTS

2.1 MATERIALS

2.1.1 Form Materials

Forms: Rigid, dimensionally stable, nonabsorptive material, warp and buckle free, that will provide precast concrete surfaces within fabrication tolerances indicated; non-reactive with concrete and suitable for producing required surface finishes.

Form-Release Agent: Commercially produced form-release agent that will not bond with, stain or affect hardening of precast concrete surfaces and will not impair subsequent surface or joint treatments.

2.1.2 Reinforcing Materials

Reinforcing Bars: ASTM A 615, Grade 60, deformed.

Low-Alloy-Steel Reinforcing Bars (Weldable rebar): ASTM A 706 deformed.

Galvanized Reinforcing Bars: ASTM A 615, Grade 60, deformed. ASTM A 767, Class II zinc coated, hot-dip galvanized and chromate wash treated after fabrication and bending.

Steel Bar Mats: ASTM A 184, fabricated from deformed bars, assembled with clips.

Plain-Steel Welded Wire Reinforcement: ASTM A 185 or ASTM A 1064, fabricated from steel wire into flat sheets.

Supports: Use bolsters, chairs, spacers, and other devices for spacing, supporting, and fastening reinforcing bars and welded wire reinforcement in place according to PCI MNL 116.

2.1.3 Concrete Materials

Portland Cement: ASTM C 150, Type I , II, or III.

Supplementary Cementitious Materials

Fly Ash: ASTM C 618, Class C or F with maximum loss on ignition of 3%.

Metakaolin: ASTM C 618, Class N.

Silica Fume: ASTM C 1240 with optional chemical and physical requirements.

Ground Granulated Blast-Furnace Slag: ASTM C 989, Grade 100 or 120.

Normalweight Aggregates: ASTM C 33, from a pit approved by Louisiana Department of Transportation.

Water: Potable; free from deleterious material that may affect color stability, setting, or strength of concrete.

2.1.4 Chemical Admixtures

Certified by manufacturer to be compatible with other admixtures and to not contain calcium chloride, or more than 0.15 percent chloride ions or other salts by weight of admixture.

Air Entraining Admixture: ASTM C 260.

Water-Reducing Admixture: ASTM C 494/C 494M, Type A.

Retarding Admixture: ASTM C 494/C 494M, Type B.

Water-Reducing and Retarding Admixture: ASTM C 494/C 494M, Type D.

Water-Reducing and Accelerating Admixture: ASTM C494/C 494M, Type E.

High Range, Water-Reducing Admixture: ASTM C 494/C 494M, Type F.

High-Range, Water-Reducing and Retarding Admixture: ASTM C 494, Type G.

Plasticizing Admixture for Flowable Concrete: ASTM C 1017.

Corrosion Inhibiting Admixture: ASTM C 1582.

2.1.5 Steel Connection Materials

Carbon-Steel Shapes and Plates: ASTM A36.

Carbon-Steel Headed Studs: ASTM A108, Grades 1010 through 1020, cold finished, AWS D1.1, Type A or B, with arc shields and with the minimum mechanical properties of PCI MNL 116, Table 3.2.3.

Carbon-Steel Plate: ASTM A283, Grade C.

Malleable Iron Castings: ASTM A47, Grade 32510 or 35028.

Carbon-Steel Castings: ASTM A27/A 27M, Grade 60-30 (Grade 415-205).

High-Strength, Low-Alloy Structural Steel: ASTM A572.

Carbon-Steel Structural Tubing: ASTM A500, Grade B or C.

Wrought Carbon-Steel Bars: ASTM A675, Grade 65.

Deformed-Steel Wire or Bar Anchors: ASTM A496 or ASTM A 706.

Inserts: ASTM A47, Grade 32510 or 35018, or ASTM A27 Grade U.

Carbon-Steel Bolts and Threaded Studs: ASTM A307, Grade A or Carbon steel, hex-head bolts and studs; carbon steel nuts ASTM A563 Grade A; and flat, unhardened steel washers ASTM F844.

High-Strength Bolts and Nuts: ASTM A193, Grade B5 or B7, ASTM A325, or ASTM A490, Type 1, heavy hex steel structural bolts, heavy hex carbon-steel nuts, ASTM A563 and hardened carbon-steel washers ASTM F436.

Galvanizing: Hot-dip process according to ASTM A123 for metal fabrications; ASTM A153, or ASTM F2329 as applicable for metal hardware.

Galvanizing Repair Paint: ASTM A780 zinc rich paint. Zinc paint with dry film containing not less than 94 percent zinc dust by weight. Comply with manufacturer's requirements for surface preparation.

Welding Electrodes: Comply with AWS standards for steel type and/or alloy being welded.

2.1.6 Grout Materials

2.1.6.1 Repair of Surface Defects

Sand-Cement Grout

Portland cement, ASTM C 150, Type I, and clean, natural sand.

Mix at ratio of 1 part cement to 2 ½ to 3 parts sand, by volume, with minimum water required for placement and hydration.

Blend normal portland cement and white cement proportioned so that the final color when cured will be the same as adjacent concrete.

2.1.6.2 Repair of minor spalling (when approved by ENGINEER)

Polymer modified cementitious repair mortar

Premixed, prepackaged, high early strength, troweled mortar.

Compressive Strength: 4000 psi at 24 hours.

Dayton Superior HD-25 or approved equal.

Install per manufacturer's recommendations.

Installation of precast connections

Non-shrink High Early Strength Grout

Premixed, prepackaged non-ferrous complying with ASTM C 1107, Grade A for drypack and Grades B and C for flowable grout.

Compressive Strength: 5,000 psi after one day, 10,000 psi after 28 days.

Dayton Superior Sure Grip High Performance Grout, or equal.

Install per manufacturer's recommendations.

Quick Setting High Strength Grout

Premixed, prepackaged non-ferrous grout with 35 minute final set time.

Compressive strength : 6,500 psi at 28 days.

Dayton Superior Re-Crete 20 Minute Set or approved equal.

Install per manufacturer's recommendations.

2.1.7 Sealant Materials

Silicone Sealant DOW Corning 888 (or approved equal).

2.1.8 Misc. Materials

Asphalt Felt: Conform to ASTM D226 Type 2, 30 lb. Weight.

2.2 CONCRETE MIXTURES

Prepare design mixtures for each type of precast concrete required. Limit use of fly ash to 25 percent replacement of portland cement by weight. Design mixtures may be prepared by a qualified independent testing agency or by qualified precast plant personnel at structural precast concrete fabricator's option. Limit water-soluble chloride ions to maximum percentage by weight of cement permitted by ACI 318 or PCI MNL 116 when tested in accordance with ASTM C 1218. Proportion mixtures by either laboratory trial batch or field test data methods according to ACI 211.1, with materials to be used on Project, to provide normalweight concrete with the following properties:

Compressive Strength: 5000 psi at 28 Days minimum.

Maximum Water-Cementitious Materials Ratio: 0.45.

When included in design mixtures, add other admixtures to concrete mixtures according to manufacturer's written instructions. Concrete Mixture Adjustments: Concrete mixture design adjustments may be proposed if characteristics of materials, Project conditions, weather, test results, or other circumstances warrant.

2.3 FORM FABRICATION

Accurately construct forms, mortar tight, of sufficient strength to withstand pressures due to concrete placement and vibration operations and temperature changes. Brace forms to prevent deformation. Maintain forms to provide completed structural precast concrete members of shapes, lines, and dimensions indicated in Contract Documents, within fabrication tolerances specified. Edge and Corner Treatment: Uniformly chamfered or radiused or as built-in on standard forms. Coat contact surfaces of forms with release agent before reinforcement is placed. Avoid contamination of reinforcement by release agent.

2.4 PRODUCTION QUALITY CONTROL PROCEDURES

Conform to PCI MNL-116 unless specified otherwise.

2.5 FABRICATION

2.5.1 Cast-in Anchors, Inserts, Plates, Angles, and Other Anchorage Hardware

Fabricate with sufficient anchorage and embedment to comply with design requirements. Accurately position for attachment of loose hardware and secure in place during precasting operations. Locate anchorage hardware where it does not affect position of main reinforcement or concrete placement. Cast-in devices, slots, and other accessories in structural precast concrete members as indicated on Contract Drawings.

Furnish loose hardware items including steel plates, clip angles, seat angles, anchors, dowels, hangers, and other hardware shapes for securing precast concrete members to supporting and adjacent construction. Cast-in all openings. Do not drill, core, or cut openings or rebar without ENGINEER's approval.

2.5.2 Reinforcement

Comply with recommendations in PCI MNL 116 for fabricating, placing, and supporting reinforcement. Clean reinforcement of loose rust and mill scale, earth, and other materials that reduce or destroy the bond with concrete. Accurately position, support, and secure reinforcement against displacement during concrete-placement and consolidation operations. Locate and support reinforcement by plastic tipped or corrosion resistant metal or plastic chairs, runners, bolsters, spacers, hangers, and other devices for spacing, supporting, and fastening reinforcing bars and welded wire reinforcement in place according to PCI MNL 116. Place reinforcing steel to maintain minimum concrete cover requirements shown on the Shop Drawings. Arrange, space, and securely tie bars and bar supports to hold reinforcement in position while placing concrete. Direct wire tie ends away from finished, exposed concrete surfaces. Reinforce structural precast concrete members to resist handling, transportation, and erection stresses, and specified in-place loads, whichever governs.

2.5.3 Concrete Placement

Concrete Mixing: Conform to ASTM C 94. Mixing operations shall produce batch-to-batch uniformity of strength, consistency, and appearance. Comply with requirements in PCI MNL 116 and in this Section for measuring, mixing, transporting, and placing concrete. Do not exceed water/cement ratio in submitted mix design unless approved by ENGINEER. Place concrete in a continuous operation to prevent cold joints or planes of weakness from forming in precast concrete members. Thoroughly consolidate placed concrete by vibration without dislocating or damaging reinforcement and built-in items, and minimize pour lines, honeycombing or entrapped air voids on surfaces. Use equipment and procedures complying with PCI MNL 116. Comply with PCI MNL 116 procedures for hot and cold-weather concrete placement. Identify pickup points of precast concrete members and orientation in structure with permanent markings, complying with markings indicated on Shop Drawings. Imprint or permanently mark casting date on each precast concrete member on a surface that will not show in finished structure.

2.5.4 Surface Finishes

2.5.4.1 Slab Surfaces

2.5.4.1.1 Surfaces subject to Pedestrian Traffic

Broomed Finish created by parallel strokes of a heavy broom in a direction transverse to traffic producing a non-slip texture.

2.5.4.1.2 Surfaces to receive Cast-In-Place Topping

Roughen Surface finish in accordance with ACI 318 which will produce a surface roughened to 1/8" amplitude.

2.5.4.2 Formed Surfaces:

2.5.4.2.1 PCI Standard Grade unless otherwise specified

Normal plant-run finish produced in forms that impart a smooth finish to concrete. Surface holes smaller than 1/2 inch caused by air bubbles, normal color variations, form joint marks, and minor chips and spalls are acceptable. Fill air holes greater than 1/4 inch in width that occur in high concentration (more than one per 2 in.²). Major or unsightly imperfections, honeycombs, or structural defects are not permitted. Allowable joint offset limited to 1/8 inch.

2.5.5 Concrete Curing

Cure concrete, according to requirements in PCI MNL 116, by moisture retention without heat. Cure members until compressive strength is high enough to ensure that stripping does not have an effect on the performance or appearance of final product. Commence curing immediately following the initial set and completion of surface finishing. Keep the temperature of the concrete between 50 and 190 degrees F.

2.5.6 Acceptance/Correction/Rejection of Defects

2.5.6.1 Minor Defects

Consists of honeycombed areas, chipped corners, air pockets over 1/4 inch in diameter, and other minor defects that involve less than 36 square inches of concrete and fins over 1/8 inch height. Remove fins by grinding smooth. Remove

unsound concrete from defective areas prior to repairing. Repair by rubbing in sand-cement grout.

2.5.6.2 Major Defects

Consists of areas greater than 36 square inches of honeycombing, air pockets greater than 1/4 inch, large spalls, broken corners, exposed reinforcing steel or cracks of a width of more than 0.01 inch. Shall be cause for rejection of the member.

2.6 TESTS, INSPECTIONS, AND VERIFICATIONS

2.6.1 Factory Inspection

At the option of ENGINEER, precast units may be inspected prior to being transported to the job site. The CONTRACTOR shall give notice 14 days prior to the time the units will be available for plant inspection. Neither the exercise nor waiver of inspection at the plant will affect the ENGINEER's right to enforce contractual provisions after units are transported or erected.

PART 3 EXECUTION

3.1 PREPARATION

Verify that all loose connection hardware and anchorage devices for precast concrete members are on site and that all shop and erection drawings pertaining to proper installation of each anchorage device are available and understood before starting that Work. Insure that erection methods do not overload completed sections of the Work.

3.2 EXAMINATION

Examine precast components for cracks, damages or other defects. Examine before unloading from delivery truck. Examine before removing from storage yard and before erection.

Examine supporting piles or other foundation for compliance with requirements for installation tolerances, bearing surface tolerances, and other conditions affecting precast concrete performance.

Proceed with precast concrete installation only after unsatisfactory conditions have been corrected.

3.3 ERECTION

Install loose clips, hangers, bearing pads, and other accessories required for connecting structural precast concrete members to supporting members and backup materials. Erect structural precast concrete level, plumb and square within the specified allowable erection tolerances. Provide temporary structural framing, shoring and bracing as required to maintain position, stability, and alignment of members until permanent connections are completed. Utilize proper handling procedures to prevent damage during shipping, storage, and erection. Units which are damaged to the extent that their structural strength is impaired will be rejected. Install in accordance with fabricator's recommendations.

Bearing Surfaces

Precast bearing surfaces

Insure surfaces are clean, flat, level, free of irregularities, and have proper clearances. Correct bearing surface irregularities by grinding.

Cast-In-Place bearing surfaces

Cast bearing surface minimum of 1/2" lower than finish bearing surface. Install slab sections on shims to proper grade. Install flowable grout bearing surface.

Clean all slab joints and remove any loose material and foreign objects before placement of units. Immediately upon placement, draw each match cast slab unit tightly against the preceding slab unit. Use mechanical assist tools as necessary to insure a tight fitting joint to the specified tolerance. Do not use pry bars or similar devices that may spall concrete edges, or create hazardous conditions. Tighten the tie rods to prescribed torque only after all slabs in a span have been placed in their final position and before any grouting.

Match-Cast Slab Grouting

Insure that proper alignment of all units within a span has been achieved before grouting. Mix and apply grout in complete accordance with manufacturer's recommendations. Neatly grout all dowel holes and blend surface to match slab finish. Leave the span undisturbed after grouting for at least 16 hours or when grout has achieved at least 3,500 psi.

Clean the structure thoroughly, inspect all joints for proper size and shape before sealing. Apply sealant in accordance with manufacturer's recommendations. Repair all damaged galvanized area with approved galvanizing repair compound. Apply in complete accordance with manufacturer's recommendations. Apply special surface treatments where required by the Contract Drawings.

Welded Connections

Comply with applicable AWS D1.1, AWS D1.4 and AWS D1.6 requirements for welding, welding electrodes, appearance of welds, quality of welds, and methods used in correcting welding work. Clean weld affected metal surfaces with chipping hammer followed by brushing or power tool cleaning, and apply a minimum 4 mil thick coat of galvanized repair paint to galvanized surfaces in conformance with ASTM A 780.

Bolted Connections

Tighten as required by Shop Drawings. Use upset threads, thread locking compound or other approved means to prevent loosening of nuts after final adjustment. Where slotted connections are used, verify bolt position and tightness at installation. For sliding connections, properly secure bolt but allow bolt to move within connection slot.

Grouting or Dry-Packing Connections

Grout indicated areas with high strength non-shrink grout. Indicate any critical grouting sequences on Shop Drawings. Provide reinforcing steel where indicated.

Retain flowable grout in place with quick setting grout dam until it

gains sufficient strength to support itself. Fill joints completely without seepage to other surfaces. Provide air vents as required to prevent air pockets.

Place grout and finish smooth, level, and plumb with adjacent concrete surfaces. Promptly remove grout material from exposed surfaces before it affects finishes or hardens. Neatly blend grouted surfaces to match adjacent finish. Keep grouted joints damp for at least 24 hours after initial set or use approved curing compound.

Field cutting of precast, prestressed concrete members is not permitted without approval of the ENGINEER. Do not use drilled or power-actuated fasteners for attaching accessory items to precast concrete members unless approved by Precast Engineer and Engineer of Record.

3.4 ERECTION TOLERANCES

Erect structural precast concrete members level, plumb, square, and in alignment without exceeding the noncumulative erection tolerances of PCI 135 unless otherwise noted.

3.4.1 Specific Tolerances

3.4.1.1 Platform Panels

3.4.1.1.1 Horizontal Location

+/- 1/8"

3.4.1.1.2 Elevation

+/- 1/8" from grade shown on Plans.

3.4.1.1.3 Level Perpendicular to Cap

+/- 1/16" across width of cap

3.4.1.1.4 Level Parallel to Cap

+/- 1/8" in 24 ft.

3.5 JOINT SEALING

3.5.1 Slab Joints Longitudinal

1/2" diameter backer rod with specified sealant.

3.5.2 Slab Joints Transverse

1/2" premolded expansion material with specified sealant.

3.5.3 Install per plan details and manufacturers recommendations.

3.6 REPAIRS

Repairs will be permitted provided structural adequacy, serviceability and durability of members and appearance are not impaired. Prepare and repair damaged galvanized coatings with galvanizing repair paint according to ASTM A 780. Remove

and replace damaged structural precast concrete members when repairs do not comply with specified requirements.

3.7 CLEANING

Clean mortar, plaster, fireproofing, weld slag, and any other deleterious material from concrete surfaces and adjacent materials immediately. Clean exposed surfaces of precast concrete members after erection and completion of joint treatment to remove weld marks, other markings, dirt, and stains.

-- End of Section --

DIVISION 05
METALS

SECTION 05 12 00
STRUCTURAL STEEL

INDEX
SECTION 05 12 00 - STRUCTURAL STEEL

PART 1	GENERAL.....	3
1.1	SCOPE	3
1.2	REFERENCES	3
1.3	MEASUREMENT AND PAYMENT	5
1.4	SUBMITTALS	5
1.5	SYSTEM DESCRIPTION	7
1.6	MODIFICATIONS TO REFERENCES	7
1.7	AISC QUALITY CERTIFICATION	7
1.8	QUALITY ASSURANCE	7
1.8.1	Drawing Requirements	7
1.8.2	Certifications	8
1.8.2.1	Erection Plan	8
1.8.2.2	Welding Procedures and Qualifications	8
PART 2	PRODUCTS.....	8
2.1	STEEL	8
2.1.1	Steel Pipe - No spiral welds allowed.	8
2.1.2	High-Strength Structural Steel	8
2.1.2.1	Low-Alloy Steel	8
2.1.3	Structural Shapes for Use in Building Framing	8
2.1.4	Channels, Angles and Plates	8
2.1.5	Steel Pipe	8
2.1.6	Wire	9
2.1.7	Plate	9
2.2	BOLTS, NUTS, AND WASHERS	9
2.2.1	Bolts	9
2.2.1.1	Nuts	9
2.2.1.2	Washers	9
2.2.2	Foundation Anchorage	9
2.2.2.1	Anchor Bolts	9
2.2.2.2	Anchor Nuts	9
2.2.2.3	Anchor Washers	9
2.3	STRUCTURAL STEEL ACCESSORIES	9
2.3.1	Welding Equipment and Materials	9
2.3.2	Non-Shrink Grout	9
2.3.3	Welded Shear Stud Connectors	10
2.3.4	Pins and Rollers	10
2.4	STAIRS	10
2.5	STAIR FRAMING	10
2.6	FLOOR GRATING TREADS AND PLATFORM	10
2.6.1	Design	10
2.7	STEEL HANDRAILS AND RAILINGS	11
2.8	DRAINAGE HOLES	11
PART 3	EXECUTION.....	11
3.1	FABRICATION	11
3.1.1	Galvanizing	11
3.2	ERECTION	11
3.2.1	Storage	11
3.3	CONNECTIONS	11
3.3.1	Common Grade Bolts	12
3.4	WELDING	12
3.4.1	Removal of Temporary Welds, Run-Off Plates, and Backing Strips ..	12
3.5	GENERAL INSTALLATION REQUIREMENTS	12
3.6	WORKMANSHIP	12
3.7	QUALITY CONTROL	13

Franklin Canal Pump Station

3.7.1	Welds	13
3.7.1.1	Visual Inspection	13
3.7.1.2	Nondestructive Testing	13
3.7.1.3	Corrections and Repairs	13
3.7.2	High-Strength Bolts	14
3.7.2.1	Testing Bolt, Nut, and Washer Assemblies	14
3.7.2.2	Inspection	14
3.7.2.3	Testing	14

SECTION 05 12 00

STRUCTURAL STEEL

PART 1 GENERAL

1.1 SCOPE

This section includes performance criteria, materials, design, production, and erection of structural steel. The work performed under this section includes all labor, material, equipment, related services, and supervision required for the manufacture and erection of the structural steel work shown on the Contract Drawings.

1.2 REFERENCES

The publications listed below form a part of this specification to the extent referenced. The publications are referred to within the text by the basic designation only.

AMERICAN ASSOCIATION OF STATE HIGHWAY AND TRANSPORTATION OFFICIALS
(AASHTO)

AASHTO HB-17 (2002; Errata 2003; Errata 2005) Standard Specifications for Highway Bridges

AMERICAN INSTITUTE OF STEEL CONSTRUCTION (AISC)

AISC 303 (2005) Code of Standard Practice for Steel Buildings and Bridges

AISC 317 (1992; Reprint 1999) ASD Manual of Steel Construction, Vol II: Connections

AISC 325 (2006) Manual of Steel Construction

AISC 326 (2009) Detailing for Steel Construction

AISC 348 (2004) Structural Joints Using ASTM A325 or A490 Bolts

AISC 350 (2005) Load and Resistance Factor Design (LRFD) Specification for Structural Steel Buildings

AISC 360 (2005) Specification for Structural Steel Buildings, with Commentary

AMERICAN PETROLEUM INSTITUTE (API)

API RP 2A-WSD (2000; Errata 2007) Recommended Practice for Planning, Designing and Constructing Fixed Offshore Platforms - Working Stress Design

API Spec 2B (2001) Specification for the Fabrication of Structural Steel Pipe

Franklin Canal Pump Station

AMERICAN WELDING SOCIETY (AWS)

AWS A2.4	(2007) Standard Symbols for Welding, Brazing and Nondestructive Examination
AWS D1.1/D1.1M	(2008; Errata 2009) Structural Welding Code - Steel
AWS D1.3/D1.3M	(2008; Errata 2008) Structural Welding Code - Sheet Steel

ASTM INTERNATIONAL (ASTM)

ASTM A 108	(2007) Standard Specification for Steel Bar, Carbon and Alloy, Cold-Finished
ASTM A 123/A 123M	(2008) Standard Specification for Zinc (Hot-Dip Galvanized) Coatings on Iron and Steel Products
ASTM A 153/A 153M	(2009) Standard Specification for Zinc Coating (Hot-Dip) on Iron and Steel Hardware
ASTM A 252	(1998; R 2007) Standard Specification for Welded and Seamless Steel Pipe Piles
ASTM A 29/A 29M	(2005) Standard Specification for Steel Bars, Carbon and Alloy, Hot-Wrought General Requirements for
ASTM A 307	(2007b) Standard Specification for Carbon Steel Bolts and Studs, 60 000 PSI Tensile Strength
ASTM A 325/A 325M	(2009) Standard Specification for Structural Bolts, Steel, Heat Treated, 120/105 ksi Minimum Tensile Strength
ASTM A 36/A 36M	(2008) Standard Specification for Carbon Structural Steel
ASTM A 490	(2008b) Standard Specification for Structural Bolts, Alloy Steel, Heat Treated, 150 ksi Minimum Tensile Strength
ASTM A 514/A 514M	(2005; R 2009) Standard Specification for High-Yield-Strength, Quenched and Tempered Alloy Steel Plate, Suitable for Welding
ASTM A 53/A 53M	(2007) Standard Specification for Pipe, Steel, Black and Hot-Dipped, Zinc-Coated, Welded and Seamless
ASTM A 563/A 563M	(2007a) Standard Specification for Carbon and Alloy Steel Nuts

Franklin Canal Pump Station

ASTM A 572/A 572M	(2007) Standard Specification for High-Strength Low-Alloy Columbium-Vanadium Structural Steel
ASTM A 6/A 6M	(2009) Standard Specification for General Requirements for Rolled Structural Steel Bars, Plates, Shapes, and Sheet Piling
ASTM A 668/A 668M	(2004; R 2009) Standard Specification for Steel Forgings, Carbon and Alloy, for General Industrial Use
ASTM A 852/A 852M	(20083; R 2007) Standard Specification for Quenched and Tempered Low-Alloy Structural Steel Plate with 70 ksi (485 MPa) Minimum Yield Strength to 4 in. (100 mm) Thick
ASTM A 992/A 992M	(2006a) Standard Specification for Structural Steel Shapes
ASTM C 827	(2010) Change in Height at Early Ages of Cylindrical Specimens from Cementitious Mixtures
ASTM C 1107/C 1107M	(2008) Standard Specification for Packaged Dry, Hydraulic-Cement Grout (Nonshrink)
ASTM F 436/F 436M	(2010) Hardened Steel Washers
ASTM F 844	(2007a) Washers, Steel, Plain (Flat), Unhardened for General Use

NATIONAL ASSOCIATION OF ARCHITECTURAL METAL MANUFACTURERS (NAAMM)

NAAMM AMP 521	(2001) Pipe Railing Manual
---------------	----------------------------

1.3 MEASUREMENT AND PAYMENT

No separate measurement or payment will be made for the material and work covered under this section. All costs in connection with this material and work shall be included in the contract unit price for the bid items to which the work pertains.

1.4 SUBMITTALS

ENGINEER approval is required for submittals with an "E" designation. Submittals with no designation are considered for information only. Submit the following:

SD-02 Shop Drawings

Erection Plan, including description of temporary supports; E

Fabrication drawings including description of connections; E

Franklin Canal Pump Station

Fabrication and installation drawings for miscellaneous weldments; E

Fabrication and installation drawings for grating; E

Fabrication and installation drawings of steel walkways, handrails and railings; E

Fabrication and installation drawings of trash screens; E

Fabrication and installation drawings of deck cover plates; E

SD-03 Product Data

Welding electrodes and rods; E

Non-Shrink Grout; E

Floor grating for platforms including clips and anchorage devices; E

Stairs; E

Welding Procedure Qualifications

Welder, welder operator and tacker qualifications

Inspector qualification

Pre-qualified procedures

Copies of the welding procedure specifications; the procedure qualification test records; and the welder, welding operator, or tacker qualification test records.

SD-06 Test Reports

Bolts, nuts, and washers; E

Supply the certified manufacturer's mill reports which clearly show the applicable ASTM mechanical and chemical requirements together with the actual test results for the supplied fasteners.

Quality Control

Nondestructive Examination

A quality assurance plan and records of tests and inspections. Submit all records of nondestructive examination in accordance with paragraph "Acceptance Requirements".

SD-07 Certificates

Steel

Bolts, nuts, and washers

Franklin Canal Pump Station

Pins and rollers

Welding procedures and qualifications; E

Certified welding procedure specifications (WPS); E

Certified brazing procedure specifications (BPS)

Certified procedure qualification records (PQR)

Certified welder performance qualifications (WPQ)

Certified brazer performance qualifications (BPQ)

1.5 SYSTEM DESCRIPTION

Provide the structural carbon system, including shop primer, complete and ready for use. Structural carbon systems including design, materials, installation, workmanship, fabrication, assembly, erection, inspection, quality control, and testing shall be provided in accordance with AISC 325 and AISC 317 except as modified in this contract. Refer to the 09 97 02 PAINTING: HYDRAULIC STRUCTURES specification for system painting requirements.

Conform the design of welded connections to AISC 360, unless otherwise indicated or specified. Material with welds shall not be accepted unless the welding is specified or indicated on the drawings or otherwise approved. Perform welding as specified in this section, except where additional requirements are shown on the drawings or are specified in other sections. Do not commence welding until welding procedures, inspectors, nondestructive testing personnel, welders, welding operators, and tackers have been qualified and the submittals approved by ENGINEER. Perform all testing at or near the work site. Records of all welding test results obtained in welding procedure, welder, welding operator and tacker performance qualifications shall be maintained by the CONTRACTOR.

1.6 MODIFICATIONS TO REFERENCES

Conform to AISC 325, AISC 317, AISC 360, AISC 303, AISC 348, and AISC 326, except as modified in this section.

1.7 AISC QUALITY CERTIFICATION

Not Required.

1.8 QUALITY ASSURANCE

1.8.1 Drawing Requirements

Submit fabrication drawings for approval prior to fabrication. Prepare in accordance with AISC 326, AISC 325 and AISC 317. Fabrication drawings shall not be reproductions of contract drawings. Include complete information for the fabrication and erection of the structure's components, including the location, type, and size of bolts, welds, member sizes and lengths, connection details, blocks, copes, and cuts. Use AWS A2.4 standard welding

Franklin Canal Pump Station

symbols. Member substitutions of details shown on the contract drawings shall be clearly highlighted on the fabrication drawings. Explain the reasons for any deviations from the contract drawings.

1.8.2 Certifications

1.8.2.1 Erection Plan

Submit for record purposes. Indicate the sequence of erection, and a detailed sequence of welding, including each welding procedure required.

1.8.2.2 Welding Procedures and Qualifications

Prior to welding, submit certification for each welder stating the type of welding and positions qualified for, the code and procedure qualified under, date qualified, and the firm and individual certifying the qualification tests. If the qualification date of the welding operator is more than one-year old, the welding operator's qualification certificate shall be accompanied by a current certificate by the welder attesting to the fact that he has been engaged in welding since the date of certification, with no break in welding service greater than 6 months.

Conform to all requirements specified in AWS D1.1/D1.1M.

PART 2 PRODUCTS

2.1 STEEL

ASTM A 36/A 36M.

2.1.1 Steel Pipe - No spiral welds allowed.

API 5L PSL1 Grade X42 Fy=42 ksi
ASTM A 500 Grade B Fy=42 ksi

2.1.2 High-Strength Structural Steel

2.1.2.1 Low-Alloy Steel

ASTM A 572/A 572M; ASTM A 992/A 992M.

2.1.3 Structural Shapes for Use in Building Framing

Wide flange shapes, ASTM A 992/A 992M, Fy = 50 ksi.

2.1.4 Channels, Angles and Plates

ASTM A 36/A 36M, Fy = 36 ksi

2.1.5 Steel Pipe

Except as otherwise noted in this specification, seamless and welded steel pipe shall comply with one of the specifications listed in API RP 2A-WSD Table 8.2.1. Welded pipe shall be with longitudinal welds and circumferential butt welds. Pipe shall be prime quality. Fabricated structural steel pipe shall be fabricated from ASTM A572 Grade 42, API 2H Grade 42, or ASTM 633 Grade A, all with Fy=42 ksi, steel. Fabricated

Franklin Canal Pump Station

structural pipe shall be fabricated in accordance with API Spec 2B or ASTM A 671 except that hydrostatic testing may be omitted. Pipe 12" diameter or smaller shall be ASTM A 53/A 53M Grade B, Fy equal to 35 ksi. Welding shall be longitudinal welds and circumferential butt welds.

2.1.6 Wire

Wire Galvanized improved plow steel 1WR @ RR-W-410D

2.1.7 Plate

ASTM A 36/A 36M, Fy = 36 ksi

2.2 BOLTS, NUTS, AND WASHERS

2.2.1 Bolts

ASTM A 325/A 325M, Type 1 ASTM A 490, Type 1 or 2.

2.2.1.1 Nuts

ASTM A 563/A 563M, Grade and Style as specified in the applicable ASTM bolt standard.

2.2.1.2 Washers

ASTM F 436/F 436M, plain carbon steel.

2.2.2 Foundation Anchorage

2.2.2.1 Anchor Bolts

ASTM A 307

2.2.2.2 Anchor Nuts

ASTM A 563/A 563M, Grade A, hex style.

2.2.2.3 Anchor Washers

ASTM F 844.

2.3 STRUCTURAL STEEL ACCESSORIES

2.3.1 Welding Equipment and Materials

Provide all welding equipment and materials, welding electrodes and rods, welding wire, and fluxes capable of producing satisfactory welds when used by a qualified welder or welding operator performing qualified welding procedures. All welding equipment and materials shall comply with the requirements of AWS D1.1/D1.1M as appropriate. All underwater welding equipment and materials shall comply with the requirements of AWS D3.6/D3.6M.

2.3.2 Non-Shrink Grout

Franklin Canal Pump Station

ASTM C 1107/C 1107M, with no ASTM C 827 shrinkage. Grout shall be nonmetallic for structure applications and metallic for machine foundations.

2.3.3 Welded Shear Stud Connectors

AWS D1.1/D1.1M.

2.3.4 Pins and Rollers

ASTM A 668/A 668M, Class C, D, F, or G; ASTM A 108, Grades 1016 to 1030. Provide as specified in AASHTO HB-17, Division II, Sections 10.26 and 10.27, except provide pins in lengths to extend a minimum of 0.25 inch beyond the outside faces of the connected parts.

2.4 STAIRS

Provide stairs as detailed, complete with stringers, landings, columns, handrails and necessary bolts and other fasteners.

Design steel stairs by a qualified professional ENGINEER in the State of Louisiana, using the criteria of OSHA 29 CFR 1910.24.

Pre-assemble items in the shop to the greatest extent possible. Disassemble units only to the extent necessary for shipping and handling. Clearly mark units for reassembly and coordinated installation.

For the fabrication of work exposed to view, use only materials that are smooth and free of surface blemishes, including pitting, seam marks, roller marks, rolled trade names, and roughness. Remove blemishes by grinding, or by welding and grinding, prior to cleaning, treating, and application of surface finishes, including zinc coating.

2.5 STAIR FRAMING

Fabricate stringers as detailed of structural steel channels, or plates, or a combination thereof as indicated. Provide closures for exposed ends of stringers.

Construct platforms of structural steel channel headers and miscellaneous framing members as indicated. Bolt headers to stringers and newels and framing members to stringers and headers.

2.6 FLOOR GRATING TREADS AND PLATFORM

Refer to Section 06 73 01 FIBERGLASS REINFORCED PLASTIC (FRP) GRATING. Provide pattern, spacing and bar sizes as indicated.

2.6.1 Design

Platform panel shall be 1 1/2 inches minimum deep and sustain a deflection of no more than 0.25 inches under uniform distributed live load of 100 psf for walkway connecting floodwall to pump station.

Stair treads shall be capable of withstanding a uniform load of 100 psf or a concentrated load of 300 lbs in the center of the tread, whichever produces greater stress.

2.7 STEEL HANDRAILS AND RAILINGS

Provide handrails and posts as detailed. Material shall be ASTM A 53/A 53M. Provide the same size rail and post in accordance with NAAMM AMP 521.

For the fabrication of work exposed to view, use only materials that are smooth and free of surface blemishes, including pitting, seam marks, roller marks, rolled trade names, and roughness. Remove blemishes by grinding, prior to cleaning, treating, and application of surface finishes, including zinc coatings.

2.8 DRAINAGE HOLES

Adequate drainage holes shall be drilled to eliminate water traps. Hole diameter shall be 1/2 inch and location shall be indicated on the detail drawings. Hole size and location shall not affect structural integrity.

PART 3 EXECUTION

3.1 FABRICATION

Fabrication shall be in accordance with the applicable provisions of AISC 325. Fabrication and assembly shall be done in the shop to the greatest extent possible.

Splices not indicated require the approval of the ENGINEER.

3.1.1 Galvanizing

Hot-dip galvanized items specified to be zinc-coated, after fabrication where practicable. Galvanizing: ASTM A 123/A 123M, ASTM A 153/A 153M.

3.2 ERECTION

Erection of structural steel shall be in accordance with the applicable provisions of AISC 325.

Provide for drainage in structural steel. After final positioning of steel members on concrete, provide full bearing under base plates and bearing plates using nonshrink grout. Place nonshrink grout in accordance with the manufacturer's instructions.

3.2.1 Storage

Material shall be stored out of contact with the ground in such manner and location as will minimize deterioration.

3.3 CONNECTIONS

Except as modified in this section, connections not detailed shall be designed in accordance with AISC 360 and AISC 350. Build connections into existing work. Punch, subpunch and ream, or drill bolt and pin holes perpendicular to the surface of the member. Holes shall not be cut or enlarged by burning. Bolts, nuts, and washers shall be clean of dirt and rust, and lubricated immediately prior to installation.

Franklin Canal Pump Station

3.3.1 Common Grade Bolts

ASTM A 307 bolts shall be tightened to a "snug tight" fit. "Snug tight" is the tightness that exists when plies in a joint are in firm contact. If firm contact of joint plies cannot be obtained with a few impacts of an impact wrench, or the full effort of a man using a spud wrench, contact the ENGINEER for further instructions.

3.3.2 High-Strength Bolts

ASTM A 325/A 325M and ASTM A 490 bolts shall be fully tensioned to 70 percent of their minimum tensile strength. Bolts shall be installed in connection holes and initially brought to a snug tight fit. After the initial tightening procedure, bolts shall then be fully tensioned, progressing from the most rigid part of a connection to the free edges.

3.4 WELDING

AWS D1.1/D1.1M, except use only shielded metal arc welding and low hydrogen electrodes for ASTM A 514/A 514M steel. Do not stress relieve ASTM A 514/A 514M steel by heat treatment. Provide AWS D1.1/D1.1M or AWS D1.6/D1.6M qualified welders, welding operators, and tackers.

The CONTRACTOR shall develop and submit the Certified Welding Procedure Specifications (WPS) for all welding, including welding done using prequalified procedures. Prequalified procedures may be submitted for information only; however, procedures that are not prequalified shall be submitted for approval.

3.4.1 Removal of Temporary Welds, Run-Off Plates, and Backing Strips

Removal is not required. Remove only from finished areas.

3.5 GENERAL INSTALLATION REQUIREMENTS

Install items at locations indicated, according to manufacturer's instructions. The CONTRACTOR shall verify all measurements and shall take all field measurements necessary before fabrication. Exposed fastenings shall be compatible materials, shall generally match in color and finish, and shall harmonize with the material to which fastenings are applied. Materials and parts necessary to complete each item, even though such work is not definitely shown or specified, shall be included. Poor matching of holes for fasteners shall be cause for rejection. Fastenings shall be concealed where practicable. Thickness of metal and details of assembly and supports shall provide strength and stiffness. Joints exposed to the weather shall be formed to exclude water. Items listed below require additional procedures.

3.6 WORKMANSHIP

Miscellaneous metal work must be well formed to shape and size with sharp lines and angles and true curves. Drilling and punching shall produce clean true lines and surfaces. Welding shall be continuous along the entire area of contact except where tack welding is permitted. Exposed connections of work in place shall not be tack welded. Exposed welds shall be ground smooth. Exposed surfaces of work in place shall have a smooth finish, and unless otherwise approved, exposed riveting shall be flush. Where tight

fits are required, joints shall be milled. Corner joints shall be coped or mitered, well formed, and in true alignment. Work shall be accurately set to established lines and elevations and securely fastened in place. Installation shall be in accordance with manufacturer's installation instructions and approved drawings, cuts and details.

Perform welding, welding inspection, and corrective welding, in accordance with AWS D1.1/D1.1M or AWS D1.3/D1.3M, as applicable. Perform underwater welding, welding inspection, and correcting welding in accordance with AWS D3.6/D3.6M, as applicable. Use continuous welds on all exposed connections. Grind visible welds smooth in the finished installation.

3.7 QUALITY CONTROL

Perform tests, and provide labor, equipment, and incidentals for testing. CONTRACTOR shall notify ENGINEER within 7 working days of beginning of welding, fabrication, or erection operations. ENGINEER shall be notified in writing of defective welds, bolts, nuts, and washers within 7 working days of the date of inspection.

3.7.1 Welds

3.7.1.1 Visual Inspection

AWS D1.1/D1.1M. Furnish the services of AWS certified welding inspectors for fabrication and erection inspection and testing and verification inspections. Welding inspectors shall visually inspect and mark welds, including fillet weld end returns. The minimum extent of visual inspection must be 100 percent of welds or joints.

3.7.1.2 Nondestructive Testing

CONTRACTOR may perform nondestructive testing the welds or joints, as indicated on the drawings. Nondestructive testing by radiographic, ultrasonic, magnetic particle, or dye penetrant methods may be performed. The type of testing to be performed is at the discretion of the ENGINEER.

For tubular joints, CONTRACTOR shall provide 100 percent UT or RT testing of all splices and joints performed in the shop and all joints welded in the field.

3.7.1.3 Corrections and Repairs

If inspection or testing indicates defects in the weld joints, repair defective welds using a qualified welder or welding operator as applicable. Conduct corrections in accordance with the requirements of AWS D1.1/D1.1M and the specifications. Repair all defects in accordance with the approved procedures. Repair defects discovered between passes before additional weld material is deposited. Wherever a defect is removed and repair by welding is not required, blend the affected area into the surrounding surface to eliminate sharp notches, crevices, or corners. After a defect is thought to have been removed, and before re-welding, examine the area by suitable methods to ensure that the defect has been eliminated. Repaired welds shall meet the inspection requirement for the original welds. Any indication of a defect is regarded as a defect, unless re-evaluation by nondestructive methods or by surface conditioning shows that no unacceptable defect is present.

3.7.2 High-Strength Bolts

3.7.2.1 Testing Bolt, Nut, and Washer Assemblies

Test bolt, nut, and washer assemblies in a tension measuring device prior to the beginning of bolting start-up. Demonstrate that the bolts and nuts, when used together, can develop tension not less than the provisions specified in AISC 348, Table 4, depending on bolt size and grade. The bolt tension shall be developed by tightening the nut.

3.7.2.2 Inspection

Inspection procedures for bolted joints shall be in accordance with AISC 348, Section 9. Confirm and report to the ENGINEER that the materials meet the project specification and that they are properly stored. Confirm that the faying surfaces have been properly prepared before the connections are assembled. Confirm that the procedure to be used provides the required tension. Monitor the work to ensure the testing procedures are routinely followed on joints that are specified to be fully tensioned.

Inspection by the ENGINEER will include proper preparation, size, gauging location, and acceptability of bolts and welds; identification marking; operation and current characteristics of welding sets in use; and calibration of torque wrenches for high-strength bolts.

The CONTRACTOR shall visually inspect proper preparation, size, gauging location, and acceptability of welds; identification marking; operation and current characteristics of welding sets in use; and calibration of torque wrenches for high-strength bolts.

The CONTRACTOR shall inspect high-strength bolted connections in accordance with AISC 317.

3.7.2.3 Testing

The ENGINEER has the option to perform nondestructive tests on 5 percent of the installed bolts to verify compliance with pre-load bolt tension requirements. The nondestructive testing will be done in-place using an ultrasonic measuring device or any other device capable of determining in-place pre-load bolt tension. The test locations shall be selected by ENGINEER. If more than 10 percent of the bolts tested contain defects identified by testing, then all bolts used from the batch from which the tested bolts were taken, shall be tested. Retest new bolts after installation.

-- End of Section --

DIVISION 06
WOOD, PLASTICS, AND COMPOSITES

SECTION 06 13 33
TIMBERWORK

INDEX
SECTION 06 13 33 TIMBERWORK

PART 1 GENERAL 2

 1.1 SCOPE 2

 1.2 REFERENCES 2

 1.3 MEASUREMENT AND PAYMENT 2

 1.4 SUBMITTALS 3

 1.5 DELIVERY AND STORAGE 3

 1.6 QUALITY ASSURANCE 3

 1.6.1 MSDS and CIS 3

 1.6.2 Timber Preservative Inspection 3

 1.6.3 Delivery Inspection List 3

PART 2 PRODUCTS 4

 2.1 MATERIALS 4

 2.1.1 Lumber and Timbers 4

 2.1.1.1 Solid Sawn..... 4

 2.1.1.2 Preservative Treatment..... 4

 2.1.2 Hardware 4

 2.1.2.1 Wire Rope and Fittings..... 4

 2.1.2.2 Zinc-Coating..... 4

PART 3 EXECUTION 4

 3.1 CONSTRUCTION 4

 3.1.1 Framing 5

 3.1.2 Framed Bents 5

 3.1.2.1 Posts and Timbers..... 5

 3.1.3 Caps 5

 3.1.4 Fastening 5

 3.2 FIELD TREATMENT 5

 3.2.1 Timberwork 5

 3.2.2 Piling and Post Protection 6

 3.2.3 Galvanized Surfaces 6

SECTION 06 13 33

TIMBERWORK

PART 1 GENERAL

1.1 SCOPE

This work consists of furnishing all labor, equipment and materials necessary to manufacture and install all timberwork in accordance with these specifications and as shown on the plans.

1.2 REFERENCES

The publications listed below form a part of this specification to the extent referenced. The publications are referred to within the text by the basic designation only.

AMERICAN WOOD PROTECTION ASSOCIATION (AWPA)

AWPA C2	(2003) Lumber, Timber, Bridge Ties and Mine Ties - Preservative Treatment by Pressure Processes
AWPA M4	(2002) Standard for the Care of Preservative-Treated Wood Products
AWPA M6	(2007) Brands Used on Forest Products
AWPA P5	(2009) Standard for Waterborne Preservatives

ASTM INTERNATIONAL (ASTM)

ASTM A 123/A 123M	(2009) Standard Specification for Zinc (Hot-Dip Galvanized) Coatings on Iron and Steel Products
ASTM A 153/A 153M	(2009) Standard Specification for Zinc Coating (Hot-Dip) on Iron and Steel Hardware
ASTM A 307	(2007b) Standard Specification for Carbon Steel Bolts and Studs, 60 000 PSI Tensile Strength

U.S. DEPARTMENT OF DEFENSE (DOD)

MIL-P-21035	(Rev B; Notice 2) Paint, High Zinc Dust Content, Galvanizing Repair (Metric)
-------------	--

U.S. GENERAL SERVICES ADMINISTRATION (GSA)

FS RR-W-410	(Rev E) Wire Rope and Strand
-------------	------------------------------

1.3 MEASUREMENT AND PAYMENT

No separate measurement or payment will be made for the material and work covered under this section, and all costs in connection therewith shall be

Franklin Canal Pump Station

included in the applicable contract price for the items to which the work pertains. Work shall include the cost of furnishing all plant, labor, and materials including timber, screws, nails, adhesives, hangers, connector plates, straps, angles, hold downs and other items incidental to the timberwork.

1.4 SUBMITTALS

ENGINEER approval is required for submittals with an "E" designation; submittals not having an "E" designation are for information only. The following shall be submitted:

SD-02 Shop Drawings

Discharge Pipe Supports - timber, E.

Submit drawings of treated timber showing dimensions of cut, framed, or bored timbers and framing details, E.

SD-06 Test Reports

Timber preservative inspection, E.

Delivery inspection list

SD-07 Certificates

MSDS and CIS

1.5 DELIVERY AND STORAGE

Open-stack untreated timber and lumber material on skids at least 12 inches aboveground, in a manner that will prevent warping and allow shedding of water. Close-stack treated timber and lumber material in a manner that will prevent long timbers or preframed material from sagging or becoming crooked. Keep ground under and within 5 feet of such piles free of weeds, rubbish, and combustible materials. Protect materials from weather. Handle treated timber with ropes or chain slings without dropping, breaking outer fibers, bruising, or penetrating surface with tools. Do not use cant dogs, peaveys, hooks, or pike poles. Protect timber and hardware from damage.

1.6 QUALITY ASSURANCE

1.6.1 MSDS and CIS

Provide Material Safety Data Sheets (MSDS) and Consumer Information Sheets (CIS) associated with timber pile preservative treatment. CONTRACTOR shall comply with all safety precautions indicated on MSDS and CIS.

1.6.2 Timber Preservative Inspection

Submit the inspection report of an independent inspection agency, for approval by the ENGINEER, that offered products complying with applicable AWWA Standards. Identify treatment on each piece by the quality mark of an agency accredited by the Board of Review of the American Lumber Standard Committee.

1.6.3 Delivery Inspection List

Franklin Canal Pump Station

Field inspect and submit a verification list of each treated timber member and each strapped bundle of treated lumber indicating the wording and lettering of the quality control markings, the species and the condition of the wood. Do not incorporate materials damaged in transport from plant to site. Inspect all preservative-treated wood visually to ensure there are no excessive residual materials or preservative deposits. Material shall be clean and dry or it will be rejected due to environmental concerns.

PART 2 PRODUCTS

2.1 MATERIALS

2.1.1 Lumber and Timbers

2.1.1.1 Solid Sawn

Provide solid sawn lumber and timbers of stress-rated Southern Pine or Douglas Fir-Larch, with a stress rating as indicated, and identified by the grade mark of a recognized association or independent inspection agency using the specific grading requirements of an association recognized as covering the species used. The association or independent inspection agency shall be certified by the Board of Review, American Lumber Standards Committee, to grade the species used.

2.1.1.2 Preservative Treatment

Fabricate lumber and timbers before preservative treatment. Each piece of treated lumber or timber shall be branded, by the producer, in accordance with AWPA M6. Dual treat wood to be used in contact with salt water or salt water splash in accordance with AWPA C2 (Material Subject to Marine Borer Exposure) with creosote and water-borne preservative. For wood not in contact with salt water or salt water splash, treatment shall be in accordance with AWPA C2 (For Above Ground, Soil Contact or Fresh Water Use) with water-borne preservative (AWPA P5). The CONTRACTOR shall be responsible for the quality of treated wood products.

2.1.2 Hardware

Bolts with necessary nuts and washers, timber connectors, drift pins, dowels, nails, screws, spikes, and other fastenings shall conform to ASTM A 307. Provide cast-iron ogee, malleable iron washers, or plate or cut washers where indicated. Provide bolts with washers under nut and head. Provide timber connectors and other metal fastenings of type and size shown. Hot-dip galvanize hardware.

2.1.2.1 Wire Rope and Fittings

FS RR-W-410, Type I, Class 2. Provide staples of 0.375 inch diameter zinc-coated steel at least 5 inches long. Provide clips or clamps of zinc-coated steel.

2.1.2.2 Zinc-Coating

Galvanize steel specified or indicated by the hot-dip process in accordance with ASTM A 123/A 123M or ASTM A 153/A 153M, as applicable.

PART 3 EXECUTION

3.1 CONSTRUCTION

Franklin Canal Pump Station

Cut, bevel, and face timbers prior to plant preservative treatment. In addition to the contract clause entitled "Accident Prevention" provide protective equipment for personnel fabricating, field treating, or handling materials treated with creosote or water-borne salts. Refer to paragraph entitled "MSDS and CIS."

3.1.1 Framing

Cut and frame lumber and timber so that joints will fit over contact surface. Secure timbers and piles in alignment. Open joints are unacceptable. Shimming is not allowed. Bore holes for drift pins and dowels with a bit 1/16 inch less in diameter than the pin or dowel. Bore holes for truss rods or bolts with a bit 1/16 inch larger in diameter than rod or bolt. Bore holes for lag screws in two parts. Make lead hole for shank the same diameter as shank. Make lead hole for the threaded portion approximately two-thirds of the shank diameter. Bore holes in small timbers for boat or wire spikes with a bit of the same diameter or smallest dimension of the spike to prevent splitting. Counter bore for countersinking wherever smooth faces are indicated or specified.

3.1.2 Framed Bents

3.1.2.1 Posts and Timbers

Provide even bearing for sills on piles. Drift bolt sills to piles with bolts of at least 3/4 inch or the indicated diameter that extend into piles at least 6 inches. When indicated, remove earth from contact with sills to provide for free air circulation. Saw posts for framed bents to proper length (vertical or batter) and provide even bearing on pedestals. Fasten posts to sills with dowels of at least 3/4 inch or the indicated diameter extending at least 6 inches into posts.

3.1.3 Caps

Prior to placing caps, prepare tops of posts or piles according to paragraphs entitled, "Field Treatment." Place timber caps to secure bearing over tops of supporting posts or piles and to secure even alignment of their ends. Secure caps by drift bolts of at least 3/4 inch or the indicated diameter extending at least 9 inches into posts or piles. Place drift bolts in the center of pile or post.

3.1.4 Fastening

Vertical bolts shall have nuts on the lower end. Where bolts are used to fasten timber to timber, timber to concrete, or timber to steel, bolt members together when they are installed and retighten immediately prior to final acceptance of contract. Provide bolts having sufficient additional threading to provide at least 3/8 inch per foot thickness of timber for future retightening. Provide timber connectors of types indicated. Install split-ring and shear-plate connectors in pre-cut grooves of the dimensions shown or as recommended by the manufacturer. Force toothed-ring and spike-grid connectors and clamping plates into the contact surfaces of timbers joined by means of proper pressure tools; at joints, embed connectors of these types simultaneously and uniformly.

3.2 FIELD TREATMENT

3.2.1 Timberwork

Field treat cuts, bevels, notches, refacing and abrasions made in the field

Franklin Canal Pump Station

in treated piles or timbers in accordance with AWPA M4, MSDS and CIS. Wood preservatives are restricted use pesticides and shall be applied according to applicable standards. Trim cuts and abrasions before field treatment. Paint depressions or openings around bolt holes, joints, or gaps including recesses formed by counterboring, with preservative treatment used for piles or timber; and after bolt or screw is in place, fill with hot pitch or a bitumastic compound.

3.2.2 Piling and Post Protection

In accordance with AWPA M4, immediately after pile or post tops are cut off and prior to placement of pile cap, protect pile or post top with several heavy applications of the same preservative used to treat the pile or post, or else copper naphthenate solutions containing a minimum of 2 percent copper metal may be used with treated products. Seal ends with a heavy application of coal-tar pitch or other appropriate sealer.

3.2.3 Galvanized Surfaces

Repair and recoat zinc coating which has been field or shop cut, burned by welding, abraded, or otherwise damaged to such an extent as to expose the base metal. Thoroughly clean the damaged area by wire brushing and remove traces of welding flux and loose or cracked zinc coating prior to painting. Paint cleaned area with two coats of zinc oxide-zinc dust paint conforming to MIL-P-21035. Compound paint with a suitable vehicle in a ratio of one part zinc oxide to four parts zinc dust by weight.

-- End of Section --

SECTION 06 73 01
FIBERGLASS REINFORCED PLASTIC (FRP) GRATING

INDEX

SECTION 06 73 01 - FIBERGLASS REINFORCED PLASTIC (FRP) GRATING

PART 1	GENERAL.....	2
1.1	SCOPE	2
1.2	REFERENCES	2
1.3	MEASUREMENT AND PAYMENT	3
1.4	SUBMITTALS	3
1.5	PERFORMANCE REQUIREMENTS	4
1.5.1	Structural Performance of Gratings	4
1.6	WARRANTY AND QUALITY ASSURANCE	4
1.7	PRODUCT DELIVERY AND STORAGE	5
PART 2	PRODUCTS.....	5
2.1	PRODUCT REQUIREMENTS	5
2.1.1	Molded FRP Grating	6
2.1.2	Fasteners	6
2.2	GRATING FABRICATION	7
PART 3	EXECUTION.....	7
3.1	GENERAL INSTALLATION REQUIREMENTS	7
3.2	ANCHORAGE, FASTENINGS, AND CONNECTIONS	7
3.3	MANUFACTURER'S WARRANTY	7

SECTION 06 73 01

FIBERGLASS REINFORCED PLASTIC (FRP) GRATING

PART 1 GENERAL

1.1 SCOPE

This Section includes, but is not limited to, new fiberglass reinforced plastic (FRP) or molded grating and treads for walkways and stairs as shown on the drawings. Furnish all labor, materials, equipment and incidentals necessary to install all FRP products as specified herein.

1.2 REFERENCES

The publications listed below form a part of this specification to the extent referenced. The publications are referred to within the text by the basic designation only.

AMERICAN SOCIETY OF CIVIL ENGINEERS (ASCE)

ASCE 7-05 (2006; Errata 2007) Minimum Design Loads for Buildings and Other Structures

ASTM INTERNATIONAL (ASTM)

ASTM D 2344/D 2344M (2000; R 2006) Standard Test Method for Short-Beam Strength of Polymer Matrix Composite Materials and Their Laminates

ASTM D 2863 (2009) Measuring the Minimum Oxygen Concentration to Support Candle-Like Combustion of Plastics (Oxygen Index)

ASTM D 635 (2006) Standard Test Method for Rate of Burning and/or Extent and Time of Burning of Self-Supporting Plastics in a Horizontal Position

ASTM D 638 (2008) Standard Test Method for Tensile Properties of Plastics

ASTM D 696 (2008) Standard Test Method for Coefficient of Linear Thermal Expansion of Plastics Between -30 degrees C and 30 degrees C With a Vitreous Silica Dilatometer

ASTM D 790 (2007e1) Flexural Properties of Unreinforced and Reinforced Plastics and Electrical Insulating Materials

ASTM D 953 (2009) Standard Test Method for Bearing Strength of Plastics

Franklin Canal Pump Station

ASTM E 662	(2009) Standard Test Method for Specific Optical Density of Smoke Generated by Solid Materials
ASTM E 84	(2009c) Standard Test Method for Surface Burning Characteristics of Building Materials
ASTM G 155	(2005a) Operating Xenon Arc Light Apparatus for Exposure of Non-Metallic Materials
ASTM G 53	(1996) Operating Light- and Water-Exposure Apparatus (Fluorescent UV-Condensation Type) for Exposure of Nonmetallic Materials

INTERNATIONAL CODE COUNCIL (ICC)

ICC IBC	(2009) International Building Code
---------	------------------------------------

U.S. DEPARTMENT OF DEFENSE (DOD)

MIL-HDBK-17-3	(Rev F) Composite Materials Handbook, Vol. 3, Polymer Matrix Composites Material Usage, Design, and Analysis
---------------	--

UNDERWRITERS LABORATORIES (UL)

UL 94	(1996; Rev thru Jun 2009) Tests for Flammability of Plastic Materials for Parts in Devices and Appliances
-------	---

1.3 MEASUREMENT AND PAYMENT

No separate measurement or payment will be made for the material and work covered under this section. All costs in connection with supply and installation of fiberglass reinforced plastic grating and accessories shall be included in the contract price for Bid Items: "Walkway Extension," "East Side Walkway," and "Deduct East Side Walkway" where fiberglass reinforced plastic grating is used.

1.4 SUBMITTALS

ENGINEER approval is required for submittals with a "E" designation; submittals not having a "E" designation are for information only. Submit the following:

SD-02 Shop Drawings

Installation Drawings, Templates, and Directions; E

SD-03 Product Data

FRP Grating; E

Clips and Anchorage; E

SD-06 Test Reports

Franklin Canal Pump Station

Bearing Strength Testing; E

Flexural Properties; E

Ultraviolet Testing; E

Shear Strength; E

Tensile Properties; E

Toxicity Testing; E

Coefficient of Lineal Thermal Expansion; E

Flame Spread Testing; E

SD-07 Certificates

Manufacturer's Sample Warranty; E

Manufacturer's Certification of State Product Approval; E

Certification of Anchorage System compliance with ASCE 7-05; E

SD-08 Manufacturer's Instructions

Shipping, Handling, Erection Procedures; E

Care and Maintenance Instructions; E

SD-11 Closeout Submittals

Manufacturer's Warranty; E

1.5 PERFORMANCE REQUIREMENTS

1.5.1 Structural Performance of Gratings

Provide gratings capable of withstanding the effects of gravity loads in accordance with ASCE 7-05, ICC IBC, and the following loads and stresses within limits and under conditions indicated:

Walkways and Elevated Platforms Used as Exits: Uniform load of 100 lb/sq.ft. for walkway. Deflection shall be limited to 1/4" for 100 lb/sq.ft.

1.6 WARRANTY AND QUALITY ASSURANCE

Provide three year manufacturer's limited warranty on all FRP products against defects in materials and workmanship. Submit Manufacturer's Sample Warranty prior to commencement of the work.

Provide items by manufacturers having a minimum of five years experience in the design and manufacture of similar products and systems. Additionally, if requested, provide a record of at least three previous, separate, similar successful installations in the last five years. Submit Manufacturer's catalog data to include two copies of manufacturer's

Franklin Canal Pump Station

specifications, load tables, dimension diagrams, and anchor details for the following items:

FRP Grating

Clips and Anchorage

Submit installation drawings, templates, and directions for installing anchorages, including sleeves, concrete inserts, anchor bolts, and items with integral anchors that are to be embedded in concrete or masonry. Submit Certification of Anchorage System compliance with ASCE 7-05. Deliver such items to the ENGINEER and the Project site prior to commencement of installation.

1.7 PRODUCT DELIVERY AND STORAGE

Submit Manufacturer's recommendations for shipping, handling, erection procedures, and care and maintenance instructions upon completion of installation. Deliver manufactured materials in original, unbroken pallets, packages, containers, or bundles bearing the label of the manufacturer. Ensure all adhesives, resins and their catalysts and hardeners are crated or boxed separately, and noted as such to facilitate their movement to a dry indoor storage facility.

Carefully handle all materials to prevent them from abrasion, cracking, chipping, twisting, other deformations, and other types of damage. Adhesives, resins and their catalysts are to be stored in dry indoor storage facilities between 70 and 85 degrees Fahrenheit until they are required.

PART 2 PRODUCTS

2.1 PRODUCT REQUIREMENTS

Provide gratings composed of continuous roving fiberglass reinforcement and resin in qualities, quantities, properties, arrangements and dimensions as necessary to meet the design requirements and dimensions as specified.

Provide resin of isophthalic polyester with chemical formulations as necessary to provide the corrosion resistance, strength and other physical properties conforming to the specified requirements.

Submit documentation for the following product tests prior to commencement of work:

Bearing Strength Testing conforming to ASTM D 953 and "Structural Performance Requirements" specified above.

Flexural Properties conforming to ASTM D 790

Minimum Flexural Strength - 30,000 psi

Minimum Flexural Modulus - 1.8×10^6 psi

Ultraviolet Testing conforming to ASTM G 155, and ASTM G 53

Franklin Canal Pump Station

Shear Strength conforming to ASTM D 2344/D 2344M

Minimum Shear Strength - 4,500 psi

Tensile Properties conforming to ASTM D 638

Minimum Tensile Strength - 30,000 psi

Toxicity Testing conforming to MIL-HDBK-17-3

Coefficient of Lineal Thermal Expansion conforming to ASTM D 696

Required Value - 8.0×10^{-6} in/in/degree F

Flame Spread Testing conforming to ASTM D 2863, ASTM E 662, and UL 94

Ensure all surfaces of FRP items and fabrications are non-slip grit, resin-rich, free of voids and without dry spots, cracks, and un-reinforced areas. Completely cover all glass fibers with resin to protect against their exposure due to ultraviolet, wear, or weathering.

Provide grating products with a flame spread rating of 25 or less per ASTM E 84 Tunnel Test. Test gratings for burn time of less than 30 seconds and an extent of burn rate of less than or equal to 10 millimeters per ASTM D 635.

2.1.1 Molded FRP Grating

Provide grating made as one piece molded construction with tops and bottoms of bearing bars and cross bars in the same plane with a rectangular mesh pattern providing unidirectional strength and reinforced with continuous roving of equal number of layers in each direction, with the top layer of reinforcement no more than 1/8 inch below the top surface of the grating to provide maximum stiffness and prevent resin chipping of unreinforced surfaces having percentage of glass (by weight) not exceed 35 percent, so as to achieve maximum corrosion resistance, and as required to maintain the structural requirements.

After molding, ensure no dry glass fibers are visible on any surface of bearing bars or cross bars, and that all bars are smooth and uniform with no evidence of fiber orientation irregularities, inter-laminar voids, porosity, resin rich or resin starved areas.

Non-slip surfacing to be manufactured with a concave, meniscus profile on the top of each bar providing maximum slip resistance.

Grating bar intersections are to be filleted to a minimum radius of 1/16 inch to eliminate local stress concentrations and the possibility of resin cracking at these locations.

Grating to be fire retardant with a tested flame spread rating of 25 or less when tested in accordance with ASTM E 84.

2.1.2 Fasteners

General: Unless otherwise indicated, provide Type 316 stainless-steel fasteners, clips and anchorage for exterior use. Select fasteners for type, grade, and class required.

2.2 GRATING FABRICATION

Verify measurements in field for work fabricated to fit field conditions as required by grating manufacturer to complete the work.

Ensure all field and shop fabricated grating cuts are coated with vinyl ester resin to provide maximum corrosion resistance in accordance with the manufacturer's instructions.

PART 3 EXECUTION

3.1 GENERAL INSTALLATION REQUIREMENTS

Install items at locations indicated, according to manufacturer's instructions. Verify all measurements and take all field measurements necessary before fabrication. Materials and parts necessary to complete each item, even though such work is not definitely shown or specified, to be included. Perform cutting, drilling, and fitting required for installing gratings. Set units accurately in location, alignment, and elevation; measured from established lines and levels and free of rack. Comply with recommendations of referenced bar grating standards, including installation clearances and standard anchoring details.

Attach removable units to supporting members with type and size of clips and fasteners indicated or, if not indicated, as recommended by grating manufacturer for type of installation conditions shown.

Attach non-removable units to supporting members by welding where both materials are same; otherwise, fasten by bolting as indicated above.

3.2 ANCHORAGE, FASTENINGS, AND CONNECTIONS

Provide anchorage where necessary for fastening miscellaneous FRP items securely in place. Include for anchorage not otherwise specified or indicated.

3.3 MANUFACTURER'S WARRANTY

Submit original and two copies of manufacturer's signed Warranty.

-- End of Section --

DIVISION 08
OPENINGS

SECTION 08 34 19.10 20
ROLLING SERVICE DOORS

INDEX

SECTION 08 34 19.10 20 - ROLLING SERVICE DOORS

PART 1 GENERAL 2

1.1 SCOPE 2

1.2 REFERENCES 2

1.3 MEASUREMENT AND PAYMENT 3

1.4 SUBMITTALS 3

1.5 DELIVERY AND STORAGE 3

PART 2 PRODUCTS 3

2.1 ROLLING SERVICE DOORS 4

2.1.1 Operational Cycle Life 4

2.2 FABRICATION 4

2.2.1 Curtains 4

2.2.2 Endlocks and Windlocks 4

2.2.3 Bottom Bar 4

2.2.4 Guides 4

2.2.5 Barrel 5

2.2.6 Brackets 5

2.2.7 Hoods 5

2.2.8 Locking Device 5

2.3 MANUAL OPERATION 5

2.3.1 Manual Hand-Chain Operation 5

2.4 FINISHES 5

2.4.1 Primed Finish 5

2.4.2 Galvanized and Shop-Primed Finish 6

PART 3 EXECUTION 6

3.1 INSTALLATION 6

3.2 FINAL ADJUSTMENT 6

SECTION 08 34 19.10 20

ROLLING SERVICE DOORS

PART 1 GENERAL

1.1 SCOPE

The work specified in this section consists of the furnishing all equipment, materials and labor for providing and installing rolling service doors as indicated on the project plans.

1.2 REFERENCES

The publications listed below form a part of this specification to the extent referenced. The publications are referred to within the text by the basic designation only.

ASTM INTERNATIONAL (ASTM)

- ASTM A123/A123M (2012) Standard Specification for Zinc (Hot-Dip Galvanized) Coatings on Iron and Steel Products
- ASTM A653/A653M (2011) Standard Specification for Steel Sheet, Zinc-Coated (Galvanized) or Zinc-Iron Alloy-Coated (Galvannealed) by the Hot-Dip Process
- ASTM A780/A780M (2009) Standard Practice for Repair of Damaged and Uncoated Areas of Hot-Dip Galvanized Coatings
- ASTM E84 (2012b) Standard Test Method for Surface Burning Characteristics of Building Materials

DOOR AND ACCESS SYSTEM MANUFACTURERS ASSOCIATION (DASMA)

- ANSI/DASMA 108 (2005) Standard Method for Testing Sectional Garage Doors and Rolling Doors: Determination of Structural Performance Under Uniform Static Air Pressure Difference

NATIONAL ELECTRICAL MANUFACTURERS ASSOCIATION (NEMA)

- NEMA ICS 1 (2000; R 2008; E 2010) Standard for Industrial Control and Systems: General Requirements
- NEMA ICS 2 (2000; R 2005; Errata 2008) Standard for Controllers, Contactors, and Overload Relays Rated 600 V
- NEMA ICS 6 (1993; R 2011) Enclosures

NEMA MG 1 (2011) Motors and Generators

NATIONAL FIRE PROTECTION ASSOCIATION (NFPA)

NFPA 70 (2011; Errata 2 2012) National Electrical Code

NFPA 80 (2013) Standard for Fire Doors and Other Opening Protectives

1.3 MEASUREMENT AND PAYMENT

No separate measurement will be made for the material and work covered under this section. Payment will be included in the contract unit price for Bid Items "Pre-engineered Metal Building 18'x25'," "Pre-engineered Metal Building 18'x50'," and "Deduct Pre-engineered Metal Building 18'x25'."

1.4 SUBMITTALS

ENGINEER approval is required for submittals with a "E" designation; submittals not having a "E" designation are for information only.

SD-02 Shop Drawings

Rolling service doors; E

Submit drawings for doors showing types, sizes, locations, metal gages, hardware provisions, installation details, and other details of construction.

SD-03 Product Data

Rolling service doors; E

SD-08 Manufacturer's Instructions

Rolling service doors

Submit manufacturer's currently recommended installation procedures for doors with the shop drawings.

SD-10 Operation and Maintenance Data

Rolling service doors, Data Package 2.

1.5 DELIVERY AND STORAGE

Protect doors and accessories from damage during delivery, storage, and handling. Clearly mark manufacturer's brand name. Store doors in dry locations with adequate ventilation, free from dust and water, and in such a manner as to permit access for inspection and handling. Handle doors carefully to prevent damage. Remove damaged items that cannot be restored to like-new condition and provide new items.

PART 2 PRODUCTS

2.1 ROLLING SERVICE DOORS

Shall be spring counterbalanced, rolling type, and shall be designed for use on exterior openings, as indicated. Doors shall be operated by hand chain with gear or sprocket reduction. Doors shall be complete with guides, hardware, fastenings, operating mechanisms, and accessories. Doors shall be surface-mounted type with guides at jambs set back a sufficient distance to provide a clear opening when door is in open position. Doors, hardware, and anchors shall be designed to withstand a wind speed of 140 mph. Sound engineering principles may be used to interpolate or extrapolate test results to door sizes not specifically tested.

2.1.1 Operational Cycle Life

All portions of the door, hardware and operating mechanism that is subject to movement, wear or stress fatigue must be designed to operate through a minimum number of 10 cycles per day.

2.2 FABRICATION

2.2.1 Curtains

Shall be formed of interlocking galvanized steel slats of shapes standard with the manufacturer, except that slats for exterior doors shall be flat type. Curtain shall roll up on a barrel supported at head of opening on brackets and be balanced by a torsion spring system in the barrel. Slats shall be of the gage required for the width indicated and the wind pressure specified above. Slats for exterior doors shall be insulated with not less than 11/16 inch thick polyurethane or polyisocyanurate foam insulation. Insulation shall have a maximum flame-spread and smoke-development indexes of 75 and 450, respectively, according to ASTM E84. Interior side of insulation shall be covered with interlocking galvanized steel slats not lighter than the standard thickness with the manufacturer.

2.2.2 Endlocks and Windlocks

The ends of each slat or each alternate slat shall have malleable iron or galvanized steel endlocks of manufacturer's stock design. In addition to endlocks, exterior doors which are more than (4877 mm) 16 feet wide or which have a design wind load of more than (0.96 kilopascals) 20 pounds per square foot, shall have windlocks of manufacturer's standard design. Windlocks shall prevent curtain from leaving guide because of deflection from wind pressure or other forces.

2.2.3 Bottom Bar

The curtain shall have a steel bottom bar consisting of two angles of equal weight, one on each side, or an approved equal extruded aluminum section, fastened to bottom of curtain. Do not use aluminum on doors more than (1877 mm) 16 feet wide. In addition, exterior doors shall have a compressible and replaceable rubber, neoprene, or vinyl weather seal attached to bottom bar.

2.2.4 Guides

Steel structural shapes or formed steel shapes fastened to wall with steel shapes not less than 3/16 inch thick. Guides shall be of sufficient depth or shall incorporate a steel locking bar to retain the curtain in place under the wind pressure specified. Provide continuous vinyl or neoprene

weather seals on guides at exterior doors. Securely attach guides to adjoining construction with not less than 3/8 inch diameter bolts, spaced near each end and not over 30 inches apart.

2.2.5 Barrel

Steel pipe or commercial welded steel tubing of proper diameter and thickness for the size of curtain. Deflection shall not exceed 0.03 inch per foot of span. Close ends of barrel with cast-iron plugs, machined to fit the pipe and either pinned or attached with screws or welded in the spring barrel, except that drive end plug may be steel welded in place. Install within the barrel an oil-tempered, stress relieved, helical, counterbalancing steel spring, capable of producing sufficient torque to assure easy operation of the door curtain from any position. At least 80 percent of the door weight shall be counterbalanced at any position. Spring-tension shall be adjustable without removing the hood.

2.2.6 Brackets

Fabricate of steel plate to support the barrel, curtain, and operator and to form a supporting ring and end closure for the hood. Provide prelubricated, self-aligning ball bearings, shielded or sealed.

2.2.7 Hoods

Steel, not lighter than 0.0209 inch thick 24 gage formed to fit contour of end brackets and reinforced with rolled beads at top and bottom edges. Provide a weather baffle at the lintel or inside the hood of each exterior door.

2.2.8 Locking Device

For each manually operated exterior rolling door provide manufacturer's external cylinder lock. The doors must open from the outside. Lock to be keyed as directed by ENGINEER.

2.3 MANUAL OPERATION

2.3.1 Manual Hand-Chain Operation

Provide galvanized, endless chain operating over a sprocket and extending to within 3 feet of floor. Obtain reduction by use of roller chain and sprocket drive or suitable gearing. Gears shall be high-grade gray iron, cast from machine-cut patterns. The pull required to operate the door shall not exceed 35 pounds.

2.4 FINISHES

Slats and hoods shall be hot-dip galvanized and shop primed. Prime finish other parts of coiling doors, except faying surfaces.

2.4.1 Primed Finish

Clean surfaces thoroughly, treat to assure maximum paint adherence, and provide a factory dip or spray coat of rust-inhibitive metallic oxide or synthetic resin primer on exposed surfaces.

2.4.2 Galvanized and Shop-Primed Finish

Surfaces specified shall have a zinc coating, a phosphate treatment, and a shop prime coat of rust-inhibitive paint. The galvanized coating shall conform to ASTM A653/A653M, coating designation (Z275) G90, for steel sheets. The weight of coatings for products shall be as designated in Table I of ASTM A123/A123M for the thickness of base metal to be coated. The prime coat shall be a type especially developed for materials treated by phosphates and adapted to application by dipping or spraying. Repair damaged zinc-coated surfaces by the materials and methods conforming to ASTM A780/A780M and spot prime. At the option of the CONTRACTOR, a two-part system including bonderizing, baked-on epoxy primer, and baked-on enamel top coat may be applied to slats and hoods before forming, in lieu of prime coat specified.

PART 3 EXECUTION

3.1 INSTALLATION

Install doors in accordance with approved detail drawings and manufacturer's directions. Locate anchors and inserts for guides, brackets, hardware, and other accessories accurately. Upon completion, doors shall be weathertight and shall be free from warp, twist, or distortion.

3.2 FINAL ADJUSTMENT

Doors shall be lubricated and properly adjusted to operate freely.

-- End of Section --

SECTION 08 91 00
METAL WALL LOUVERS

INDEX
SECTION 08 91 00 - METAL WALL LOUVERS

PART 1	GENERAL	2
1.1	SCOPE	2
1.2	REFERENCES	2
1.3	MEASUREMENT AND PAYMENT	3
1.4	SUBMITTALS	3
1.5	DELIVERY, STORAGE, AND PROTECTION	4
1.6	DETAIL DRAWINGS	4
1.7	COLOR SAMPLES	4
PART 2	PRODUCTS	4
2.1	MATERIALS	4
2.2	METAL WALL LOUVERS	4
2.2.1	Frame	4
2.2.2	Blades	4
2.2.3	Construction	4
2.2.4	Birdscreen	4
2.2.5	Sill Pan	4
2.2.6	Finish	5
2.2.7	Angles	5
2.2.8	Section Size	5
2.2.9	Shape	5
2.2.10	Mullions and Mullion Covers	5
2.3	FASTENERS AND ACCESSORIES	5
2.4	FINISHES	5
PART 3	EXECUTION	5
3.1	INSTALLATION	5
3.1.1	Wall Louvers	5
3.1.2	Screens and Frames	5
3.2	PROTECTION FROM CONTACT OF DISSIMILAR MATERIALS	5
3.2.2	Aluminum	6
3.2.3	Metal	6

SECTION 08 91 00

METAL WALL LOUVERS

PART 1 GENERAL

1.1 SCOPE

The work specified in this section consists of the furnishing all equipment, materials and labor for providing and installing metal wall louvers as indicated on the project plans.

1.2 REFERENCES

The publications listed below form a part of this specification to the extent referenced. The publications are referred to within the text by the basic designation only.

AIR MOVEMENT AND CONTROL ASSOCIATION INTERNATIONAL (AMCA)

- AMCA 500-L (2012) Air Performance, Water Penetration and Wind Driven Rain.
- AMCA 511 (2010) Certified Ratings Program for Air Control Devices
- AMCA 540 (2010) Test Method for Louvers Impacted by Wind Borne Debris (Basic Protection, Missile Level D and Enhanced Protection, Missile Level E).

ALUMINUM ASSOCIATION (AA)

- AA DAF45 (2003; Reaffirmed 2009) Designation System for Aluminum Finishes

AMERICAN ARCHITECTURAL MANUFACTURERS ASSOCIATION (AAMA)

- AAMA 2603 (2002) Voluntary Specification, Performance Requirements and Test Procedures for Pigmented Organic Coatings on Aluminum Extrusions and Panels
- AAMA 2604 (2005) Voluntary Specification, Performance Requirements and Test Procedures for High Performance Organic Coatings on Aluminum Extrusions and Panels
- AAMA 2605 (2005) Voluntary Specification, Performance Requirements and Test Procedures for Superior Performing Organic Coatings on Aluminum Extrusions and Panels
- AAMA 611 (1998; R 2004) Voluntary Specification for Anodized Architectural Aluminum

ASTM INTERNATIONAL (ASTM)

ASTM A1008/A1008M	(2012) Standard Specification for Steel, Sheet, Cold-Rolled, Carbon, Structural, High-Strength Low-Alloy and High-Strength Low-Alloy with Improved Formability, Solution Hardened, and Bake Hardened
ASTM A167	(1999; R 2009) Standard Specification for Stainless and Heat-Resisting Chromium-Nickel Steel Plate, Sheet, and Strip
ASTM A653/A653M	(2011) Standard Specification for Steel Sheet, Zinc-Coated (Galvanized) or Zinc-Iron Alloy-Coated (Galvannealed) by the Hot-Dip Process
ASTM B209	(2010) Standard Specification for Aluminum and Aluminum-Alloy Sheet and Plate
ASTM B209M	(2010) Standard Specification for Aluminum and Aluminum-Alloy Sheet and Plate (Metric)
ASTM B221	(2012) Standard Specification for Aluminum and Aluminum-Alloy Extruded Bars, Rods, Wire, Profiles, and Tubes
ASTM B221M	(2012) Standard Specification for Aluminum and Aluminum-Alloy Extruded Bars, Rods, Wire, Profiles, and Tubes (Metric)

1.3 MEASUREMENT AND PAYMENT

No separate measurement will be made for the material and work covered under this section. Payment will be included in the contract unit price for Bid Items "Pre-engineered Metal Building 19'x25'," "Pre-engineered Metal Building 18'x50'," and "Deduct Pre-engineered Metal Building 18'x25'."

1.4 SUBMITTALS

ENGINEER approval is required for submittals with an "E" designation; submittals not having an "E" designation are for information only. The following shall be submitted:

SD-02 Shop Drawings

Wall louvers, E.

SD-03 Product Data

Metal Wall Louvers, E.

1.5 DELIVERY, STORAGE, AND PROTECTION

Deliver materials to the site in an undamaged condition. Carefully store materials off the ground to provide proper ventilation, drainage, and protection against dampness. Louvers shall be free from nicks, scratches, and blemishes. Replace defective or damaged materials with new.

1.6 DETAIL DRAWINGS

Show all information necessary for fabrication and installation of [wall louvers](#). Indicate materials, sizes, thicknesses, fastenings, and profiles.

1.7 COLOR SAMPLES

Colors of finishes for [wall louvers](#) shall closely approximate colors indicated. Where color is not indicated, submit the manufacturer's standard colors to the ENGINEER for selection.

PART 2 PRODUCTS

2.1 MATERIALS

2.2 METAL WALL LOUVERS

Stationary horizontal blade wind-driven rain extruded aluminum type, with bird screens and made to withstand a wind load of not less than [200 pounds per square foot](#). Wall louvers shall bear the AMCA certified ratings program seal for air performance, water penetration, and wind and impact resistance in accordance with [AMCA 500-L](#), [AMCA 511](#), and [AMCA 540](#). The rating shall show a water penetration of [0.20 or less ounce per square foot](#) of free area at a free velocity of [800 feet per minute](#).

Greenheck EHH-501X model louvers with core area greater than or equal to 49 square feet per power unit or approved equal. Louvers must be able to accommodate a minimum of 20,000 cfs air flow per power unit or air flow of power units.

2.2.1 Frame

Heavy gauge extruded 6063-T5 aluminum alloy, 5 in. x 0.081 in nominal wall thickness.

2.2.2 Blades

Horizontal rain resistant style, heavy gauge extruded 6063-T5 aluminum alloy, [0.081 inch](#) nominal wall thickness, 2 in. spacing.

2.2.3 Construction

Mechanically Fastened.

2.2.4 Birdscreen

0.75 inch x 0.051 inch flattened expanded aluminum in removable frame, inside mount (rear).

2.2.5 Sill Pan

Franklin Canal Pump Station

Formed Aluminum

2.2.6 Finish

Mill

2.2.7 Angles

Continuous, ship loose (mill finish)

2.2.8 Section Size

Louver sections shall be no smaller than 12 inches width x 7 inches height, and no larger than 84 inches width x 144 inches height or 120 inches width x 84 inches height.

Louver size to be coordinated with building manufacturer.

2.2.9 Shape

Louver sections shall only be of rectangular shape.

2.2.10 Mullions and Mullion Covers

Same material and finish as louvers. Provide mullions for all louvers exceeding the maximum width as specified in Section 2.2.8. Provide mullions covers on both faces of joints between louvers.

2.3 FASTENERS AND ACCESSORIES

Provide stainless steel screws and fasteners. Provide other accessories as required for complete and proper installation.

2.4 FINISHES

Exposed surfaces shall be factory finished with a 2-coat 70% KYNAR 500/HYLAR 5000 AAMA 2605 - dry film thickness 1.2 mil. (AKA: Duranar, Fluoropon, Trinar, Fluoropolymer, Polyvinylidene Fluoride, PVDF2). Color shall be standard color - smoke (GF104). Louvers shall have the same finish.

PART 3 EXECUTION

3.1 INSTALLATION

3.1.1 Wall Louvers

Install using stops or moldings, flanges, strap anchors, or jamb fasteners as appropriate for the wall construction and in accordance with manufacturer's recommendations.

3.1.2 Screens and Frames

Attach frames to louvers with screws or bolts.

3.2 PROTECTION FROM CONTACT OF DISSIMILAR MATERIALS

3.2.2 Aluminum

Where aluminum contacts metal other than zinc, paint the dissimilar metal with a primer and two coats of aluminum paint.

3.2.3 Metal

Paint metal in contact with mortar, concrete, or other masonry materials with alkali-resistant coatings such as heavy-bodied bituminous paint.

-- End of Section --

DIVISION 09
FINISHES

SECTION 09 97 02
PAINING, HYDRAULIC STRUCTURES

INDEX
SECTION 09 97 02 - PAINTING: HYDRAULIC STRUCTURES

PART 1 GENERAL 2

 1.1 SCOPE 2

 1.2 REFERENCES 2

 1.3 MEASUREMENT AND PAYMENT 2

 1.4 SUBMITTALS 2

 1.5 SYSTEM DESCRIPTION 3

 1.6 SAFETY AND HEALTH PROVISIONS 3

PART 2 PRODUCTS 3

 2.1 PAINT MATERIALS 3

PART 3 EXECUTION 4

 3.1 DELIVERY, STORAGE, AND HANDLING 4

 3.2 PAINT SCHEDULE 4

 3.3 SURFACE PREPARATION 5

 3.3.1 Ferrous Metal Surfaces 5

 3.3.1.1 Surface Preparation for Ferrous Metals 5

 3.3.1.2 Field Touch Up 5

 3.3.2 Nonferrous Metal Surfaces 6

 3.3.3 Touch Up 6

 3.4 SHOP PAINTING 6

 3.5 APPLICATION OF PAINT 6

 3.5.1 General 6

 3.5.2 Mixing and Thinning 7

 3.6 PROTECTION OF OTHER FACILITIES 8

 3.6.1 Fabricated and Assembled Items 8

 3.7 INSPECTION 8

 3.8 WORK IN CONFINED SPACES 9

 3.9 PRODUCT SCHEDULES 9

 3.9.1 Pump Station 9

 3.9.1.1 Below Elevation +4.0 NAVD88 9

 3.9.1.2 Above Elevation +4.0 NAVD88 9

 3.9.1.3 Not Used 9

 3.9.1.4 Handrails 9

 3.9.2 Piling 10

 3.9.2.1 Piling 10

SECTION 09 97 02

PAINTING: HYDRAULIC STRUCTURES

PART 1 GENERAL

1.1 SCOPE

The work specified in this section consists of the furnishing all equipment, materials and labor for painting all hydraulic structures.

1.2 REFERENCES

NOT USED

1.3 MEASUREMENT AND PAYMENT

No separate measurement or payment will be made for the material and work covered under this section, and all costs in connection therewith shall be included in the applicable contract price for the items to which the work pertains.

1.4 SUBMITTALS

ENGINEER approval is required for submittals with an "E" designation. Submittals with no designation are considered for information only. Submit the following:

SD-03 Product Data

Product Data Sheets; E

Material Safety Data Sheets; E

System Description; E

Complete Schedule of Surface Preparations and Paint Systems as described in the Paint Schedule Section.

Safety and Health Plan; E

Manufacturer's Standard Color Card

Paint Formulas; E

Paint Formulations; E

For products that are specified to be applied in accordance with the manufacturer's recommendations also submit the paint producer's product data sheet or other written instructions for those products.

SD-06 Test Reports

Inspections; E

Records of inspections and operations performed. Submittals shall be made on a daily basis.

Franklin Canal Pump Station

SD-07 Certificates

Coating Thickness Gage Qualification; E

Documentation of manufacturer's certification shall be submitted for all coating thickness gages.

1.5 SYSTEM DESCRIPTION

The CONTRACTOR shall furnish all painting materials and equipment and shall perform all labor necessary to provide a finished and completely acceptable painting job for the entire project. Painting work shall be done only at such times and under such conditions to assure a durable, dust-free, and workmanlike job. All painting work shall be done in strict accordance with the paint manufacturer's published instructions in concert with this section of the specifications. Where manufacturer's recommended materials, surface preparation, number of coats or mil thicknesses exceed those shown in the specifications, the recommendations of the manufacturer shall govern.

All new and existing structures and appurtenances included in this Project which are customarily painted shall be painted with not less than one shop coat and two field coats, or one prime coat and two finish coats of the appropriate paint unless otherwise specified.

Baked on enamel finishes and items with standard shop finishes, graphic panels, electrical equipment, instrumentation, etc., shall not be repainted unless otherwise specified. Aluminum, stainless steel, copper, bronze and plastic shall not be painted unless otherwise noted.

The CONTRACTOR shall purchase paint from an approved manufacturer.

1.6 SAFETY AND HEALTH PROVISIONS

A safety and health plan must be developed by a Qualified Professional with a minimum of 3 years of demonstrated experience in similar related work.

PART 2 PRODUCTS

2.1 PAINT MATERIALS

Paint Formulas:

Paints shall have the composition as indicated in the formulas listed herein. Submit manufacturer's product data sheets, material safety data sheets and standard color cards for each type of paint used.

The term paint shall mean both paints and coatings whether used as prime, intermediate, or finish coats.

The CONTRACTOR shall coordinate the paint products to be used such that shop and field coats are compatible. The CONTRACTOR shall coordinate the use of coatings such that shop coatings and field coatings are supplied by the same manufacturer, and that shop and field coats are compatible.

PART 3 EXECUTION

3.1 DELIVERY, STORAGE, AND HANDLING

All materials shall be brought to the job site in the original sealed and labeled containers of the paint manufacturer and shall be subject to inspection by the ENGINEER. Where thinning is necessary, only the product of the manufacturer furnishing the paint shall be used. All such thinning shall be done strictly in accordance with the manufacturer's instructions.

Process and package paints to ensure that within a period of one year from date of manufacture, they will not gel or thicken deleteriously, or form gas in the closed container. Paints, unless otherwise specified or permitted, shall be packaged in standard containers not larger than 5 gallons, with removable friction or lug-type covers. Each container of paint or separately packaged component thereof shall be labeled to indicate the purchaser's order number, date of manufacture, manufacturer's batch number, quantity, color, component identification and designated name, and formula or specification number of the paint together with special labeling instructions. Paints that can be harmed by exposure to cold weather shall be stored in ventilated, heated shelters. All paints shall be stored under cover from the elements and in locations free from sparks and flames.

3.2 PAINT SCHEDULE

The CONTRACTOR shall prepare a complete schedule of surface preparations and paint systems he proposes to use in the work. This schedule shall list all interior and exterior surfaces, and all major equipment to be painted. The schedule shall be in conformance with the Contract Documents. The schedule shall reflect the paint manufacturer's recommendations for the coating systems. The schedule shall itemize each painted item or surface and shall contain the following information in neat tabular form:

1. Type of surface preparation (note whether shop or field preparation)
2. Paint system (generic name)
3. Prime coat (product, number of coats, dry mil thickness per coat, square feet coverage per gallon)
4. Intermediate coat, if required (product, number of coats, dry mil thickness per coat, square feet coverage per gallon)
5. Finish coat (product, number of coats, color, dry mil thickness per coat, square feet coverage per gallon)
6. Painting status at time of installation
7. Remarks (any special treatment or application requirements, etc.)

The schedule shall contain the name and address of the paint manufacturer. The schedule shall be in conformance with the criteria of Paragraph 3.9 - Product Schedules. Manufacturer's recommended dry mil thickness shall be incorporated into the schedule. The schedule shall be submitted to the ENGINEER as soon as possible following the award of contract.

3.3 SURFACE PREPARATION

All surfaces to be painted shall be prepared in a workmanlike manner with the objective of obtaining a clean and dry surface free from dust, rust, scale and all foreign matter. No painting shall be done before the surfaces meet the requirements of the paint manufacturer.

Hardware accessories, machined surfaces, plates, lighting fixtures and similar items in place prior to cleaning and painting, and not intended to be painted, shall be protected or removed during painting operations and repositioned upon completion of painting operations. Machinery shall be protected against entry of blast abrasive and dust into working parts. Surfaces to be painted that will be inaccessible after construction, erection, or installation operations are completed shall be painted before they become inaccessible.

All surface preparations shall be in strict accordance with the recommendations of the paint manufacturer.

3.3.1 Ferrous Metal Surfaces

All ferrous surfaces shall be abrasive blasted in accordance with SSPC SP 10 Near White Metal Blast Cleaning. Cleaning and priming shall be done in the shop unless otherwise directed or permitted.

All surfaces shall be primed as soon as practicable after cleaning but prior to contamination or deterioration of the prepared surfaces. To the greatest degree possible, steel surfaces shall be cleaned (and primed) prior to lengthy outdoor storage.

3.3.1.1 Surface Preparation for Ferrous Metals

Surface preparation criteria for ferrous metals, as defined by the Steel Structures Painting Council, are as follows:

SSPC-SP 1 - Solvent cleaning - Removal of oil, grease, dirt, soil, salts, and contaminants by cleaning with solvent, vapor, alkali, emulsion, or steam.

SSPC-SP 6 - Commercial Blast Cleaning - Removal of at least two-thirds of all visible rust, mill scale, paint and other foreign matter from each square inch of surface by compressed air nozzle blasting, centrifugal wheels or other specified method.

SSPC-SP 7 - Brush-Off Blast Cleaning - Removal of loose rust, mill scale, paint and foreign matter from the surface by compressed air nozzle blasting, centrifugal wheels or other specified methods.

SSPC-SP 10 - Near-White Blast Cleaning - Blast cleaning nearly to white metal cleanliness, until at least 95 percent of each element of surface area is free of all visible residues.

3.3.1.2 Field Touch Up

All welds and damaged areas shall be spot blasted in accordance with SSPC SP 10 Near-White Metal Blast Cleaning; edges shall be feathered to create a smooth transition. When typing into existing coatings and the recoat window of existing coatings has expired, brush-off blast in accordance with SSPC SP 7 Brush-Off Blast

Franklin Canal Pump Station

Cleaning. Prime with the specified primer.

3.3.2 Nonferrous Metal Surfaces

All nonferrous metals, whether to be shop or field primed, shall be solvent cleaned (SSPC-SP 1) prior to the application of the pretreatment and/or primer. One coat of an appropriate passivator or conditioner shall be applied to all nonferrous metals before applying the prime coat. The passivator or conditioner shall be compatible with the complete paint system.

3.3.3 Touch Up

Any abraded areas of shop or field applied coatings shall be touched up with the same type of shop or field applied coating, even to the extent of applying an entire coating, if necessary. Touchup coatings and surface preparations shall be in addition to and not considered as the first field coat.

3.4 SHOP PAINTING

All fabricated steel work and equipment shall receive at the factory at least one (1) shop coat of prime paint compatible with the paint system required by these specifications. Surface preparation prior to shop painting shall be as specified in Paragraph 3.3 - Surface Preparation. All shop painted items shall be properly packaged and stored until they are incorporated in the work. Any painted surfaces that are damaged during handling, transportation, storage or installation shall be cleaned, scraped, and patched before field painting begins so that the work shall be equal to the original painting received at the shop. Equipment or steel work that is to be assembled on the site shall likewise receive a minimum of one shop coat of paint at the factory. The paints and surface preparation used for shop coating shall be identified on shop drawings submitted to the ENGINEER. Where the exact identity of shop primer cannot be determined, or where primer differs from that specified, CONTRACTOR shall perform a near-white abrasive blast cleaning (SSPC-SP 10) followed by specified paint system.

In lieu of the above, the CONTRACTOR has the option of shipping bare metal to the job site and applying a near-white abrasive blast cleaning (SSPC-SP 10), followed by a field prime coat immediately thereafter.

3.5 APPLICATION OF PAINT

3.5.1 General

CONTRACTOR shall apply all coatings prior to moving the gate to the site. The only coating application to be done at the site on the barge gate shall be touch up. Touch up shall utilize material and methods as per manufacturer's recommendations. The finished coating shall be free from holidays, pinholes, bubbles, runs, drops, ridges, waves, laps, excessive or unsightly brush marks, and variations in color, texture, and gloss. Application of initial or subsequent coatings shall not commence until ENGINEER has verified that atmospheric conditions and the surfaces to be coated are satisfactory. The CONTRACTOR shall follow a system of tinting successive paint coats so that no two coats for a given surface are exactly the same color. Each paint coat shall be applied in a manner that will produce an even, continuous film of uniform thickness. Edges, corners, crevices, seams, joints, welds, rivets, corrosion pits, and other surface irregularities shall receive a stripe coat to ensure that they receive an adequate thickness of paint. All materials shall be applied in accordance with the manufacturer's instructions.

Franklin Canal Pump Station

Paint shall be applied at the rate specified by the manufacturer to achieve the minimum dry mil thickness required. Additional coats of paint shall be applied, if necessary, to obtain thickness specified.

Application shall be by spraying where recommended by the manufacturer. If the material has thickened or must be diluted for application by spray gun, each coat shall be built up to the same film thickness achieved with undiluted brushed-on material. Where thinning is necessary and approved, only the products of the particular manufacturer furnishing the paint shall be used, and all such thinning shall be done in strict accordance with the manufacturer's instructions.

Paint shall be applied only to surfaces that are above the dew point temperature and that are completely free of moisture as determined by sight and touch. Paint shall not be applied to surfaces upon which there is detectable frost or ice. Except as otherwise specified, the temperature of the surfaces to be painted and of air in contact therewith shall be not less than 45 degrees F during paint application nor shall paint be applied if the surfaces can be expected to drop to 32 degrees F or lower before the film has dried to a reasonably firm condition. During periods of inclement weather, painting may be continued by enclosing the surfaces and applying artificial heat, provided the minimum temperatures and surface dryness requirements prescribed previously are maintained. Paint shall not be applied to surfaces heated by direct sunlight or other sources to temperatures that will cause detrimental blistering, pinholing, or porosity of the film.

A minimum of 24 hours drying time shall elapse between applications of any two coats of paint on a particular surface, unless otherwise recommended by the coating manufacturer. Longer drying times may be required for abnormal conditions in concert with the manufacturer's recommendations. Sufficient time shall elapse between successive coats to permit them to dry properly for recoating, and this period shall be modified as necessary to suit adverse weather conditions. Paint shall be considered dry for recoating when it feels firm, does not deform or feel sticky under moderate pressure of the finger, and the application of another coat of paint does not cause film irregularities such as lifting or loss of adhesion of the undercoat. All coats of all painted surfaces shall be unscarred and completely integral at the time of application of succeeding coats. At the time of application of each successive coat, undercoats shall be cleaned of dust, grease, overspray, or foreign matter by means of airblast, solvent cleaning, or other suitable means.

Minimum drying periods after final coat prior to immersion shall be: epoxy systems at least 5 days, vinyl-type paint systems at least 3 days, and cold-applied coal tar epoxy systems at least 7 days. Minimum drying periods shall be increased if the drying temperature is below 75 degrees F and/or if the immersion exposure involves considerable abrasion.

3.5.2 Mixing and Thinning

Paints shall be thoroughly mixed and thinned in accordance with manufacturer's instructions. Where necessary to suit conditions of the surface temperature, weather, and method of application, the paint may be thinned immediately prior to use. Paint that has been stored at low temperature, shall be brought up to at least 70 degrees F before being mixed and thinned, and its temperature in the spray tank or other working container shall not fall below 60 degrees F during the application. Paint that has deteriorated in any manner to a degree that it cannot be restored to essentially its original condition by customary field-mixing methods shall not be used and shall be removed from the project site.

3.6 PROTECTION OF OTHER FACILITIES

The CONTRACTOR shall be responsible for the cleanliness of all painting operations and shall use covers and masking tape to protect the work wherever such covering is necessary. The CONTRACTOR shall protect not only the CONTRACTOR's own work, but also protect all adjacent work and materials by adequate covering with drop cloths.

Any unwanted paint shall be carefully removed without damage to any finished paint or surface. If damage does occur, the entire surface adjacent to and including the damaged area shall be repainted without visible lap marks.

The CONTRACTOR shall not use any plumbing fixture or waste piping for mixing of paint or disposal of any refuse material. All waste shall be disposed of properly into a suitable receptacle located outside of the building.

3.6.1 Fabricated and Assembled Items

Items that have been fabricated and/or assembled into essentially their final form and that are customarily cleaned and painted in accordance with the manufacturer's standard practice will be exempted from equivalent surface preparation and painting requirements described herein, provided that:

- a. Surfaces primed (only) in accordance with such standard practices are compatible with specified field-applied finish coats.
- b. Surfaces that have been primed and finish painted in accordance with the manufacturer's standard practice are of acceptable color and are capable of being satisfactorily touched up in the field.
- c. Items expressly designated herein to be cleaned and painted in a specified manner are not coated in accordance with the manufacturer's standard practice if different from that specified herein.

3.7 INSPECTION

Inspect, document, and report all work phases and operations on a daily basis. As a minimum the daily report shall contain the following:

- a. Inspections performed, including the area of the structure involved and the results of the inspection.
- b. Surface preparation operations performed, including the area of the structure involved, the mode of preparation, the kinds of solvent, abrasive, or power tools employed, and whether contract requirements were met.
- c. Thinning operations performed, including thinners used, batch numbers, and thinner/paint volume ratios.
- d. Application operations performed, including the area of the structure involved, mode of application employed, ambient temperature, substrate temperature, dew point, relative humidity, type of paint with batch numbers, elapsed time between surface preparation and application, elapsed time for recoat, condition of underlying coat, number of coats applied, and if specified, measured dry film thickness or spreading rate of each new coating.

Franklin Canal Pump Station

3.8 WORK IN CONFINED SPACES

The CONTRACTOR shall provide and maintain safe working conditions for all employees. CONTRACTOR shall comply fully with the provisions or latest revisions or issue of OSHA, NIOSH, NYCOSH.

3.9 PRODUCT SCHEDULES

Unless noted otherwise, the paint system shall be a high-build, two-component, polyamide cured, modified epoxy product, forming a tough, hard wearing coating with good resistance to water and petroleum products.

Any ferrous items not specifically called to be painted shall be hot dipped galvanized. No ferrous components shall remain uncoated or not galvanized.

3.9.1 Pump Station

3.9.1.1 Below Elevation +4.0 NAVD88

1st Coat - Apply Hempel's 45880-50630 Red Epoxy 7 Mils wet to achieve 5 Mils dry or apply Carboline's Carboguard 890 Red Epoxy 8 mils wet to achieve 5 mils dry (or EQUAL).

2nd Coat - Apply Hempel's 45880-01410 Buff Epoxy 7 Mils wet to achieve 5 Mils dry or apply Carboline's Cargoguard 890 Buff Epoxy 8 Mils wet to achieve 5 Mils dry (or EQUAL). (See below for anti-foulant requirement.)

Top Coat - Apply Hempel's Antifoulant Olympic 76600-51110 6 Mils wet to achieve 4 Mils dry or apply Carboline's Antifoulant C-Flex 1-2-3 AF 7 Mils wet to achieve 4 Mils dry (or EQUAL).

Marine Antifoulant - Hempel's 76600 (or EQUAL) should be on 2nd Coat of Epoxy (45880 or EQUAL) within 4-5 hours at 78°F, or tacky; Carboline's C-Flex 1-2-3 AF (or EQUAL) should be applied over 2nd coat of Carboguard 890 (or EQUAL) while it is still tacky. Submit antifoulant product data for approval by ENGINEER.

3.9.1.2 Above Elevation +4.0 NAVD88 (Does not include metal building)

1st Coat - Apply Hempel's 45880-50630 Red Epoxy 7 Mils wet to achieve 5 Mils dry or apply Carboline's Carboguard 890 Red Epoxy 8 Mils wet to achieve 5 Mils dry (or EQUAL).

2nd Coat - Apply Hempel's 45880-01410 Buff Epoxy 7 Mils wet to achieve 5 Mils dry or apply Carboline's Carboguard Buff Epoxy 8 Mils wet to achieve 5 Mils dry (or EQUAL).

Top Coat - Apply Hempel's Hemptthane Topcoat 55210-11480 Gray 4 Mils wet to achieve 2 Mils dry or apply Carboline's Carbothane 134 HG Gray 4 Mils wet to achieve 2 mils dry (or EQUAL).

3.9.1.3 Not Used

3.9.1.4 Handrails

Franklin Canal Pump Station

The handrails paint system shall be as follows unless otherwise specified:

1st Coat - Apply zinc rich primer to achieve 3 mils dry. Hempel's 17360-19830 or Carboline's Carbozinc 808 (or EQUAL).

2nd Coat - Apply epoxy coating to achieve 5 mils dry. Hempel's 45889-01410 or Carboline's Carboguard 890 (or EQUAL).

Top Coat - Apply polyurethane coating topcoat to achieve 2 mils dry. Hempel's 58210-20300 Safety Yellow or Carboline's Carbothane 134 HG Safety Yellow (or EQUAL).

Miscellaneous hardware as noted shall be hot-dipped galvanized.

3.9.2 Piling

3.9.2.1 Piling

To be used for:

Top 15 feet of discharge pipe support piles.

1st Coat - Apply Hempel's 45880-50630 Red Epoxy 7 Mils wet to achieve 5 Mils dry or apply Carboline's Carboguard 890 Red Epoxy 8 Mils wet to achieve 5 Mils dry (or EQUAL).

2nd Coat - Apply Hempel's 45880-01410 Buff Epoxy 7 Mils wet to achieve 5 Mils dry or apply Carboline's Carboguard Buff Epoxy 8 Mils wet to achieve 5 Mils dry (or EQUAL).

Top Coat - Apply Hempel's Hemptthane Topcoat 55210-11480 Gray 4 Mils wet to achieve 2 Mils dry or apply Carboline's Carbothane 134 HG Gray 4 Mils wet to achieve 2 mils dry (or EQUAL).

3.9.3 Vertical Axial Flow Pump and Associated Piping

1st Coat - Apply Hempel's 45880-50630 Red Epoxy 7 Mils wet to achieve 5 Mils dry or apply Carboline's Carboguard 890 Red Epoxy 8 Mils wet to achieve 5 Mils dry (or EQUAL).

2nd Coat - Apply Hempel's 45880-01410 Buff Epoxy 7 Mils wet to achieve 5 Mils dry or apply Carboline's Carboguard Buff Epoxy 8 Mils wet to achieve 5 Mils dry (or EQUAL).

Top Coat - Apply Hempel's Hemptthane Topcoat 55210-11480 Gray 4 Mils wet to achieve 2 Mils dry or apply Carboline's Carbothane 134 HG Gray 4 Mils wet to achieve 2 mils dry (or EQUAL).

-- End of Section --

DIVISION 10
SPECIALTIES

SECTION 10 14 01
EXTERIOR SIGNAGE

INDEX
SECTION 10 14 01 - Exterior Signage

PART 1	GENERAL.....	2
1.1	REFERENCES	2
1.2	GENERAL REQUIREMENTS	3
1.2.1	Wind Load Requirements	3
1.2.2	Character Proportions and Heights	3
1.3	SUBMITTALS	4
1.4	MEASUREMENT AND PAYMENT	4
1.5	QUALIFICATIONS	4
1.6	DELIVERY AND STORAGE	4
1.7	WARRANTY	4
PART 2	PRODUCTS.....	5
2.1	MODULAR EXTERIOR SIGNAGE SYSTEM	5
2.1.1	Panel Type Sign	5
2.2	GRAPHICS FOR EXTERIOR SIGNAGE SYSTEMS	5
2.2.1	Graphics	5
2.2.2	Messages	5
2.3	ALUMINUM ALLOY PRODUCTS	6
2.4	ORGANIC COATING	6
2.5	ANCHORS AND FASTENERS	6
2.6	SHOP FABRICATION AND MANUFACTURE	6
2.6.1	Factory Workmanship	6
2.6.2	Dissimilar Materials	6
2.7	COLOR, FINISH, AND CONTRAST	6
PART 3	EXECUTION.....	6
3.1	INSTALLATION	6
3.1.1	Anchorage	7
3.1.2	Protection and Cleaning	7

Franklin Canal Pump Station

PART 1 GENERAL

1.1 REFERENCES

The publications listed below form a part of this specification to the extent referenced. The publications are referred to within the text by the basic designation only.

ALUMINUM ASSOCIATION (AA)

AA DAF45 (2003; Reaffirmed 2009) Designation System for Aluminum Finishes

AMERICAN NATIONAL STANDARDS INSTITUTE (ANSI)

ANSI Z97.1 (2009; Errata 2010) Safety Glazing Materials Used in Buildings - Safety Performance Specifications and Methods of Test

AMERICAN WELDING SOCIETY (AWS)

AWS C1.1M/C1.1 (2012) Recommended Practices for Resistance Welding

AWS D1.1/D1.1M (2010; Errata 2011) Structural Welding Code - Steel

AWS D1.2/D1.2M (2008) Structural Welding Code - Aluminum

ASTM INTERNATIONAL (ASTM)

ASTM A1011/A1011M (2013) Standard Specification for Steel, Sheet, and Strip, Hot-Rolled, Carbon, Structural, High-Strength Low-Alloy and High-Strength Low-Alloy with Improved Formability and Ultra-High Strength

ASTM A123/A123M (2013) Standard Specification for Zinc (Hot-Dip Galvanized) Coatings on Iron and Steel Products

ASTM A36/A36M (2012) Standard Specification for Carbon Structural Steel

ASTM A653/A653M (2011) Standard Specification for Steel Sheet, Zinc-Coated (Galvanized) or Zinc-Iron Alloy-Coated (Galvannealed) by the Hot-Dip Process

ASTM A924/A924M (2013) Standard Specification for General Requirements for Steel Sheet, Metallic-Coated by the Hot-Dip Process

ASTM B108/B108M (2012; E 2012) Standard Specification for Aluminum-Alloy Permanent Mold Castings

ASTM B209	(2010) Standard Specification for Aluminum and Aluminum-Alloy Sheet and Plate
ASTM B209M	(2010) Standard Specification for Aluminum and Aluminum-Alloy Sheet and Plate (Metric)
ASTM B221	(2013) Standard Specification for Aluminum and Aluminum-Alloy Extruded Bars, Rods, Wire, Profiles, and Tubes
ASTM B221M	(2013) Standard Specification for Aluminum and Aluminum-Alloy Extruded Bars, Rods, Wire, Profiles, and Tubes (Metric)
ASTM B26/B26M	(2012) Standard Specification for Aluminum-Alloy Sand Castings
ASTM B62	(2009) Standard Specification for Composition Bronze or Ounce Metal Castings
ASTM C1036	(2010; E 2012) Standard Specification for Flat Glass
ASTM D3841	(1997; E 2008; R 2008) Standard Specification for Glass Fiber-Reinforced Polyester Plastic Panels
ASTM E84	(2013a) Standard Test Method for Surface Burning Characteristics of Building Materials
NATIONAL ASSOCIATION OF ARCHITECTURAL METAL MANUFACTURERS (NAAMM)	
NAAMM AMP 500	(2006) Metal Finishes Manual

1.2 GENERAL REQUIREMENTS

All exterior signage shall be provided by a single manufacturer. Exterior signage shall be of the design, detail, sizes, types, and message content described herein, shall conform to the requirements specified, and shall be provided at the locations indicated. Signs shall be complete with lettering as detailed and related components for a complete installation. Each sample shall consist of a complete sign panel with letters and symbols. Samples may be installed in the work, provided each sample is identified and location recorded. Submit three color samples for each material requiring color and 12 inch square sample of sign face color sample.

1.2.1 Wind Load Requirements

Exterior signage shall be designed to withstand 140 mph wind load. Submit design analysis and supporting calculations performed in support of specified signage.

1.2.2 Character Proportions and Heights

Franklin Canal Pump Station

Characters and numbers on indicated signs shall be sized according to the viewing distance from which they are to be read. The minimum height and width shall be 8 inches and 5 inches respectively, measured using an upper case letter "X". Lower case characters are permitted.

1.3 SUBMITTALS

Engineer approval is required for submittals with a "E" designation; submittals not having a "E" designation are for information only. Submit the following;

SD-02 Shop Drawings

Approved Detail Drawings; E

SD-03 Product Data

Modular Exterior Signage System
Installation
Exterior Signage; E
Wind Load Requirements

SD-04 Samples

Exterior Signage; E

SD-10 Operation and Maintenance Data

Protection and Cleaning

SD-11 Closeout Submittals

1.4 MEASUREMENT AND PAYMENT

Exterior signage will be measured per each sign installed, to include all labor, materials, and machinery required to furnish and install project identification signage complete with lettering, fasteners and logo.

Project identification signage will be paid for at the contract unit price for Bid Item; "Exterior Signage."

1.5 QUALIFICATIONS

Signs, logos, and dimensional letters shall be the standard product of a manufacturer regularly engaged in the manufacture of the products. Items of equipment shall essentially duplicate equipment that has been in satisfactory use at least 2 years prior to bid opening.

1.6 DELIVERY AND STORAGE

Materials shall be wrapped for shipment and storage, delivered to the jobsite in manufacturer's original packaging, and stored in a clean, dry area in accordance with manufacturer's instructions.

1.7 WARRANTY

Manufacturer's standard performance guarantees or warranties that extend beyond a one year period shall be provided.

PART 2 PRODUCTS

2.1 MODULAR EXTERIOR SIGNAGE SYSTEM

Exterior signage shall consist of identification type signs located on the pump station exterior walls. Dimensions, details, materials, message content, and design of signage shall be as specified herein. Submit manufacturer's descriptive data and catalog cuts.

2.1.1 Panel Type Sign

2.1.1.1 Panels

Modular message panels shall be 40" tall x 104" wide, and shall display message and logo illustrated in Figure 1. Panels shall be fabricated a minimum of 0.1875 inch aluminum.

2.1.1.2 Finishes

Metal panel system finish shall be baked enamel or two-component acrylic polyurethane.

2.1.1.3 Mounting

Signage shall be mounted directly to prefabricated metal building, and coordinated with metal building manufacturer.

2.2 GRAPHICS FOR EXTERIOR SIGNAGE SYSTEMS

2.2.1 Graphics

Pressure sensitive precision cut vinyl letters and logo with reflecting surface shall be provided.

2.2.2 Messages

See Figure 1 for message content. Typeface: Helvetica medium.



Figure 1: Typical Pump Station Identification Signage

Franklin Canal Pump Station

2.3 ALUMINUM ALLOY PRODUCTS

Aluminum alloy products shall conform to [ASTM B209M \(ASTM B209\)](#) for sheet or plate.

2.4 ORGANIC COATING

Clean, prime and give surfaces a semi-gloss baked enamel or two-component acrylic polyurethane finish in accordance with [NAAMM AMP 500](#), AMP 505, with total dry film thickness not less than 1.2 mils.

2.5 ANCHORS AND FASTENERS

Exposed anchor and fastener materials shall be compatible with metal to which applied and shall match in color and finish and shall be non-rusting, non-corroding, and non-staining. Exposed fasteners shall be tamper-proof. Anchors and fasteners shall be sufficient to withstand 140 mph wind load.

2.6 SHOP FABRICATION AND MANUFACTURE

2.6.1 Factory Workmanship

Work shall be assembled in the shop, as far as practical, ready for installation at the site. Work that cannot be shop assembled shall be given a trial fit in the shop to ensure proper field assembly. Holes for bolts and screws shall be drilled or punched. Drilling and punching shall produce clean, true lines and surfaces. Welding to or on structural steel shall be in accordance with [AWS D1.1/D1.1M](#). Welding shall be continuous along the entire area of contact. Exposed welds shall be ground smooth. Exposed surfaces of work shall have a smooth finish and exposed riveting shall be flush. Fastenings shall be concealed where practical. Other metallic coatings of steel sheet shall be in accordance with [ASTM A924/A924M](#).

2.6.2 Dissimilar Materials

Where dissimilar metals are in contact, or where aluminum is in contact with concrete, or wet or pressure-treated wood, the surfaces shall be protected with a coat of asphalt varnish or a coat of zinc-molybdate primer to prevent galvanic or corrosive action.

2.7 COLOR, FINISH, AND CONTRAST

Color shall be selected from manufacturers standard colors. Color listed is not intended to limit the selection of equal colors from other manufacturers. Characters and symbols shall contrast with their background - either light characters on a dark background or dark characters on a light background. Logo colors shall be as illustrated in Figure 1.

PART 3 EXECUTION

3.1 [INSTALLATION](#)

Signs shall be installed in accordance with approved manufacturer's instructions centered on the land side (north side) and water side (south side) of the pre-fabricated metal building; submit drawings showing elevations of each type of sign; dimensions, details, and methods of mounting or anchoring; shape and thickness of materials; and details of

construction. Signs shall be installed plumb and true at mounting heights directed by the Engineer, and by method shown or specified. Signs mounted on other surfaces shall not be installed until finishes on such surfaces have been completed. Submit manufacturer's installation instructions and cleaning instructions.

3.1.1 Anchorage

Anchorage and fastener materials shall be in accordance with approved manufacturer's instructions for the indicated substrate. Anchorage not otherwise specified or indicated shall include slotted inserts, expansion shields, and machine carriage bolts for steel.

3.1.2 Protection and Cleaning

The work shall be protected against damage during construction. Hardware and electrical equipment shall be adjusted for proper operation. After signs are completed and inspected, cover all project identification which may mislead the public. Covering shall be maintained until instructed to be removed by the Owner or until the facility is to be opened for business. Submit six copies of maintenance instructions listing routine maintenance procedures, possible breakdowns and repairs, and troubleshooting guides. The instructions shall include simplified diagrams for the equipment as installed. Signs shall be cleaned, as required, at time of cover removal.

-- End of Section --

DIVISION 13
SPECIAL CONSTRUCTION

SECTION 13 34 19
METAL BUILDING SYSTEMS

INDEX
SECTION 13 34 19 - METAL BUILDING SYSTEMS

PART 1	GENERAL	2
1.1	SCOPE	2
1.2	REFERENCES	2
1.3	MEASUREMENT AND PAYMENT.....	6
1.4	SUBMITTALS.....	7
1.5	RELATED DOCUMENTS.....	8
1.6	DESCRIPTION.....	8
1.7	DESIGN RESPONSIBILITY.....	8
1.7.1	Deflection Limits	9
1.8	QUALITY ASSURANCE.....	9
1.9	PRODUCT DELIVERY.....	10
1.10	WARRANTY.....	10
1.11	DEFINITIONS.....	10
PART 2	PRODUCTS	11
2.1	GENERAL.....	11
2.2	MANUFACTURERS.....	12
2.3	STRUCTURAL FRAMING AND ROOF AND SIDING PANELS.....	12
2.4	ANCHORAGE.....	12
PART 3	EXECUTION	13
3.1	EXAMINATION.....	13
3.2	PREPARATION.....	13
3.3	INSTALLATION.....	13

SECTION 13 34 19

METAL BUILDING SYSTEMS

PART 1 GENERAL

1.1 SCOPE

The work specified in this section consists of the furnishing all equipment, materials and labor for providing and installing a pre-engineered metal building as indicated on the project plans.

1.2 REFERENCES

The publications listed below form a part of this specification to the extent referenced. The publications are referred to within the text by the basic designation only.

AMERICAN ARCHITECTURAL MANUFACTURERS ASSOCIATION (AAMA) [AAMA/WDMA/CSA](#)

[101/I.S.2/A440](#) (2011) Standard/Specification for Windows, Doors, and Skylights

AMERICAN INSTITUTE OF STEEL CONSTRUCTION (AISC)

[AISC 325](#) (2011) Steel Construction Manual

[AISC 360](#) (2010) Specification for Structural Steel Buildings

AMERICAN IRON AND STEEL INSTITUTE (AISI)

[AISC/AISI 121](#) (2004) Standard Definitions for Use in the Design of Steel Structures

[AISI SG03-3](#) (2002; Suppl 2001-2004; R 2008) Cold-Formed Steel Design Manual Set

AMERICAN SOCIETY OF CIVIL ENGINEERS (ASCE)

[ASCE 7](#) (2010; Change 2010; Change 2011; Errata 2011; Change 2011) Minimum Design Loads for Buildings and Other Structures

AMERICAN WELDING SOCIETY (AWS)

[AWS A5.1/A5.1M](#) (2012) Specification for Carbon Steel Electrodes for Shielded Metal Arc Welding

[AWS D1.1/D1.1M](#) (2012; Errata 2011) Structural Welding Code - Steel

[AWS D1.3/D1.3M](#) (2008; Errata 2008) Structural Welding Code - Sheet Steel

ASTM INTERNATIONAL (ASTM)

ASTM A1008/A1008M	(2012) Standard Specification for Steel, Sheet, Cold-Rolled, Carbon, Structural, High-Strength Low-Alloy and High-Strength Low-Alloy with Improved Formability, Solution Hardened, and Bake Hardened
ASTM A1011/A1011M	(2012) Standard Specification for Steel, Sheet, and Strip, Hot-Rolled, Carbon, Structural, High-Strength Low-Alloy and High-Strength Low-Alloy with Improved Formability and Ultra-High Strength
ASTM A123/A123M	(2012) Standard Specification for Zinc (Hot-Dip Galvanized) Coatings on Iron and Steel Products
ASTM A153/A153M	(2009) Standard Specification for Zinc Coating (Hot-Dip) on Iron and Steel Hardware
ASTM A193/A193M	(2012a) Standard Specification for Alloy-Steel and Stainless Steel Bolting Materials for High-Temperature Service and Other Special Purpose Applications
ASTM A307	(2010) Standard Specification for Carbon Steel Bolts and Studs, 60 000 PSI Tensile Strength
ASTM A325	(2010) Standard Specification for Structural Bolts, Steel, Heat Treated, 120/105 ksi Minimum Tensile Strength
ASTM A325M	(2009) Standard Specification for Structural Bolts, Steel, Heat Treated, 830 MPa Minimum Tensile Strength (Metric)
ASTM A36/A36M	(2008) Standard Specification for Carbon Structural Steel
ASTM A463/A463M	(2010) Standard Specification for Steel Sheet, Aluminum-Coated, by the Hot-Dip Process
ASTM A475	(2003a; E 2009; R 2009) Standard Specification for Zinc-Coated Steel Wire Strand
ASTM A500/A500M	(2010a) Standard Specification for Cold-Formed Welded and Seamless Carbon Steel Structural Tubing in Rounds and Shapes
ASTM A501	(2007) Standard Specification for Hot-Formed Welded and Seamless Carbon Steel Structural Tubing
ASTM A529/A529M	(2005; R 2009) Standard Specification for High-

	Strength Carbon-Manganese Steel of Structural Quality
ASTM A53/A53M	(2012) Standard Specification for Pipe, Steel, Black and Hot-Dipped, Zinc-Coated, Welded and Seamless
ASTM A563/A563M	(2007a) Standard Specification for Carbon and Alloy Steel Nuts
ASTM A572/A572M	(2012) Standard Specification for High-Strength Low-Alloy Columbium-Vanadium Structural Steel
ASTM A653/A653M	(2011) Standard Specification for Steel Sheet, Zinc-Coated (Galvanized) or Zinc-Iron Alloy-Coated (Galvannealed) by the Hot-Dip Process
ASTM A755/A755M	(2011) Standard Specification for Steel Sheet, Metallic Coated by the Hot-Dip Process and Prepainted by the Coil-Coating Process for Exterior Exposed Building Products
ASTM A780/A780M	(2009) Standard Practice for Repair of Damaged and Uncoated Areas of Hot-Dip Galvanized Coatings
ASTM A792/A792M	(2010) Standard Specification for Steel Sheet, 55% Aluminum-Zinc Alloy-Coated by the Hot-Dip Process
ASTM A992/A992M	(2011) Standard Specification for Structural Steel Shapes
ASTM B117	(2011) Standard Practice for Operating Salt Spray (Fog) Apparatus
ASTM B209	(2010) Standard Specification for Aluminum and Aluminum-Alloy Sheet and Plate
ASTM B209M	(2010) Standard Specification for Aluminum and Aluminum-Alloy Sheet and Plate (Metric)
ASTM B221	(2012) Standard Specification for Aluminum and Aluminum-Alloy Extruded Bars, Rods, Wire, Profiles, and Tubes
ASTM B221M	(2012) Standard Specification for Aluminum and Aluminum-Alloy Extruded Bars, Rods, Wire, Profiles, and Tubes (Metric)
ASTM B695	(2004; R 2009) Standard Specification for Coatings of Zinc Mechanically Deposited on Iron and Steel
ASTM C1363	(2011) Standard Test Method for Thermal

	Performance of Building Materials and Envelope Assemblies by Means of a Hot Box Apparatus
ASTM C518	(2010) Steady-State Thermal Transmission Properties by Means of the Heat Flow Meter Apparatus
ASTM C920	(2011) Standard Specification for Elastomeric Joint Sealants
ASTM D1056	(2007) Standard Specification for Flexible Cellular Materials - Sponge or Expanded Rubber
ASTM D2247	(2011) Testing Water Resistance of Coatings in 100% Relative Humidity
ASTM D523	(2008) Standard Test Method for Specular Gloss
ASTM D6226	(2010) Standard Test Method for Open Cell Content of Rigid Cellular Plastics
ASTM DEFONLINE	(2008) ASTM Online Dictionary of Engineering Science and Technology
ASTM E119	(2012a) Standard Test Methods for Fire Tests of Building Construction and Materials
ASTM E136	(2012) Behavior of Materials in a Vertical Tube Furnace at 750 Degrees C
ASTM E1592	(2005; R 2012) Structural Performance of Sheet Metal Roof and Siding Systems by Uniform Static Air Pressure Difference
ASTM E1646	(1995; R 2011) Standard Test Method for Water Penetration of Exterior Metal Roof Panel Systems by Uniform Air Pressure Difference
ASTM E331	(2000; R 2009) Water Penetration of Exterior Windows, Skylights, Doors, and Curtain Walls by Uniform Static Air Pressure Difference
ASTM E84	(2012b) Standard Test Method for Surface Burning Characteristics of Building Materials
ASTM E96/E96M	(2010) Standard Test Methods for Water Vapor Transmission of Materials
ASTM F1554	(2007a; E 2011) Standard Specification for Anchor Bolts, Steel, 36, 55, and 105-ksi Yield Strength
ASTM F1852	(2011) Standard Specification for "Twist Off" Type Tension Control Structural Bolt/Nut/Washer Assemblies, Steel, Heat Treated, 120/105 ksi Minimum Tensile Strength

- ASTM F436 (2011) Hardened Steel Washers
- ASTM F436M (2011) Hardened Steel Washers (Metric) ASTM
- F844 (2007a) Washers, Steel, Plain (Flat), Unhardened for General Use
- ASTM G152 (2006) Operating Open Flame Carbon Arc Light Apparatus for Exposure of Nonmetallic Materials
- ASTM G153 (2004; R 2010) Operating Enclosed Carbon Arc Light Apparatus for Exposure of Nonmetallic Materials
- INTERNATIONAL CODE COUNCIL (ICC)
- IBC (2009) International Building Code
- METAL BUILDING MANUFACTURERS ASSOCIATION (MBMA)
- MBMA MBSM (2002) Metal Building Systems Manual
- NATIONAL ASSOCIATION OF ARCHITECTURAL METAL MANUFACTURERS (NAAMM) NAAMM
- AMP 500 (2006) Metal Finishes Manual
- NATIONAL FIRE PROTECTION ASSOCIATION (NFPA)
- NFPA 252 (2012) Standard Methods of Fire Tests of Door Assemblies
- NFPA 80 (2013) Standard for Fire Doors and Other Opening Protectives
- NATIONAL ROOFING CONTRACTORS ASSOCIATION (NRCA)
- NRCA RoofMan (2012) The NRCA Roofing Manual

1.3 MEASUREMENT AND PAYMENT

Measurement of the pre-engineered metal building shall be on a lump sum basis.

Price and payment for pre-engineered metal building shall be full compensation for all labor, materials, tools and equipment and all appurtenances for the complete construction of the pre-fabricated metal building. This item includes but is not limited to required submittals, engineering submittals including drawings and specifications, and all incidentals necessary to make the pre-fabricated building complete. This item includes purchase and installation of metal building and framing, doors, ridge vents, louvers, and fire extinguishers. Payment will be made under Bid Item "Pre-engineered Metal Building 18'x25'" for the Base Bid. For Bid Alternate 1, the payment of Bid Item "Pre-engineered Metal Building 18'x25'" is deducted and payment of Bid Item "Pre-engineered Metal Building 18'x50'" is added.

1.4 SUBMITTALS

SD-02 Design Data

Provide detailed design criteria and calculations prepared by a licensed structural ENGINEER.

Professional ENGINEER's certificate prepared and signed by a Professional ENGINEER, legally authorized to practice in the State of Louisiana and the specific jurisdiction where Project is located, verifying that the structural framing and covering panels meet indicated loading requirements and codes of authorities having jurisdiction.

SD-03 Certification

Manufacturer certification that the building conforms to the contract documents and manufacturer's standard design procedures.

SD-05 Product Data

Should consist of metal building system manufacturer's product information for building components and accessories.

For building accessory components, provide details of metal building accessory components to clearly indicate methods of installation.

SD-06 Shop Drawings

For metal building structural framing system, roofing, ridge vents, siding, linear and soffit panels, and other metal building system components and accessories that are not fully detailed or dimensioned in manufacturer's product data.

As required, show additional framing, components, or adaptations associated with providing the natural gas and electrical systems in and to the building. Include details associated with installation of louvers, rollup doors, and swing doors.

For structural framing, furnish complete erection drawings prepared by or under the supervision of a professional ENGINEER legally authorized to practice in the jurisdiction where the Project is located. Include details showing fabrication and assembly of the metal building system. Show embedded base plate/column connection and sidewall, endwall, and roof framing. Include transverse cross-sections.

For roofing, siding, and soffit panels provide layouts of panels on walls, roofs, and ceilings, details of edge connections, joints, corners, custom profiles, supports, anchorages, trim, flashings, closures, and special details. Include transverse cross-sections.

SD-07 Materials

Samples for initial selection purposes in form of manufacturer's color charts or chips showing full range of colors, textures, and patterns available for

metal roofing, siding, liner and soffit panels with factory-applied finishes.

Samples for verification purposes of roofing, siding, liner and soffit panels. When directed by ENGINEER provide sample panels 12-inch long by actual panel width, in the profile, style, color, and texture indicated. Include clips, battens, fasteners, closures, and other panel accessories.

1.5 RELATED DOCUMENTS

Drawings and general provisions of the Contract, including General Conditions, Special Conditions and Division 1 Specifications Sections, apply to this Section. This information is intended to supplement applicable DOTD Standard Specification Sections which are incorporated by reference.

1.6 DESCRIPTION

CONTRACTOR shall furnish all labor, materials and equipment, and perform all operations necessary to fabricate, erect and construct a prefabricated steel building including: all primary and secondary structural framing members, connection bolts, roof, louvers, ridge vents, cut-outs for wall penetrations, roll-up and swinging doors, flashing, fasteners, closures, sealer, foundation and other miscellaneous items as required for the complete construction of a prefabricated steel building and as indicated in the contract plans and this specification. CONTRACTOR shall also prepare and acquire all required permits for the construction of the pre-fabricated metal building.

A single-story, single-span, rigid-clear-span type pre-engineered metal building without interior columns, of the nominal length, width, eave height, and roof pitch indicated.

Dimension Requirements:

Width (ft)	18.0
Length (ft)	50.0
Eave Height (ft)	16.0
Roof Slope (rise/12)	1.0
Bay Spacing (ft)	As shown in drawings

Exterior walls are covered with un-insulated, prefinished, metal building wall panels attached to substrate members using exposed fasteners. Roof system consists of the manufacturer's standard roof panels attached to framing using exposed fasteners.

The metal building and foundation system is designed as a complete system. All components of the system shall be provided or specified by in the submittal.

1.7 DESIGN RESPONSIBILITY

Apply all loading in accordance with the International Building Code, 2009 edition

and ASCE 7-10.

ENGINEER, design, fabricate and erect the pre-engineered metal building system to withstand loads from winds, gravity, structural movement including movement thermally induced, and to resist in-service use conditions that the building will experience, including exposure to the weather, without failure.

Temperature Change (Range); 120 F, ambient; 180 F, material surfaces.

Design each member to withstand stresses resulting from combinations of loads that produce the maximum allowable stresses in that member as prescribed in MBMA's "Design Practices Manual." The design wind speed is 140 miles per hour. Design connection to connect columns to plates embedded in slab.

1.7.1 Deflection Limits

ENGINEER assemblies to withstand design loads with deflections no greater than the following:

Purlins and Rafters

Vertical deflection of 1/150 of the span.

Girts

Horizontal deflection of 1/90 of the span.

Metal Roof Panels

Vertical deflection of 1/60 of the span.

Metal Wall Panels

Horizontal deflection of 1/60 of the span.

Design secondary framing system to accommodate deflection of primary building structure and construction tolerances, and to maintain clearances at openings. Provide metal panel assemblies capable of withstanding the effects of loads and stresses indicated, based on testing according to [ASTM E1592](#).

1.8 QUALITY ASSURANCE

Engage an experienced Installer to erect the pre-engineered metal building who has specialized in the erection and installation of types of metal buildings systems similar to that required for this project and who is acceptable to the metal building system manufacturer as qualified for erection of the manufacturer's products. Installer shall have minimum 20 years of experience.

The drawings indicate sizes, profiles, and dimensional requirements of the pre-engineered metal building system. Metal building systems having equal performance characteristics with deviations from indicated dimensions and profiles may be considered, provided deviations do not change the design concept or intended performance. The burden of proof for equality is on the proposer.

1.9 PRODUCT DELIVERY

CONTRACTOR shall arrange and be responsible for delivery and storage of material, and for its safekeeping.

Each package shall be clearly marked on the outside to show the contents and specific location in the work.

1.10 WARRANTY

The CONTRACTOR shall guarantee all materials, equipment and workmanship for a period of one year from the date of final acceptance of the project. This guarantee shall include all labor and material necessary to make any repairs, adjustments or replacement of any component necessary to restore project to first class condition.

Special warranties specified in this Article shall not deprive the OWNER of other rights the OWNER may have under other provisions of the Contract Documents and shall be in addition to, and run concurrent with, other warranties made by the CONTRACTOR under requirements of the Contract Documents.

Submit a written warranty, signed by manufacturer, covering failure of the factory-applied exterior finish on metal roof and soffit panels and associated trim within the specified warranty period and agreeing to repair finish or replace roof and soffit panels that show evidence of finish deterioration. Deterioration of finish includes, but is not limited to, color fade, chalking, cracking, peeling, and loss of film integrity.

Warranty is concluded 20 years from date of Acceptance.

Submit a written warranty executed by CONTRACTOR and Installer agreeing to repair or replace metal roof panel assembly that fails to remain weathertight within the specified warranty period. CONTRACTOR's weathertight warranty period expires 2 years after the Date of Acceptance.

1.11 DEFINITIONS

Bay: Dimension between main frames measured normal to frame (at centerline of frame) for interior bays, and dimension from centerline of first interior main frame measured normal to end wall (outside face of end-wall girt) for end bays.

Building Length: Dimension of the building measured perpendicular to main framing from end wall to end wall (outside face of girt to outside face of girt).

Building Width: Dimension of the building measured parallel to main framing from sidewall to sidewall (outside face of girt to outside face of girt).

Clear Span: Distance between supports of beams, girders, or trusses (measured from lowest level of connecting area of a column and a rafter frame or knee).

Eave Height: Vertical dimension from finished floor to eave (the line along the sidewall formed by intersection of the planes of the roof and wall).

Clear Height under Structure: Vertical dimension from finished floor to lowest

point of any part of primary or secondary structure, not including crane supports, located within clear span.

Terminology Standard: Refer to MBMA "Metal Building Systems Manual" for definitions of terms for metal building system construction not otherwise defined in this Section or in referenced standards.

PART 2 PRODUCTS

2.1 GENERAL

All components of the system, including foundation, shall be provided or specified by the manufacturer.

Materials shall comply with the following:

Hot-rolled structural steel shapes should comply with ASTM A 36, A 529, or A 992.

Steel tubing or pipe should comply with ASTM A 500, Grade B, ASTM A 501, or ASTM A 53.

Steel members fabricated from plate or bar stock should provide 42,000 psi minimum yield strength with ASTM A 529, ASTM A 570, or ASTM A 572.

Steel members fabricated by cold forming should comply with ASTM A 607, Grade 50.

Cold-rolled carbon steel sheet should comply with requirements of ASTM A 366 or ASTM A 568.

Hot-rolled carbon steel sheet should comply with requirements of ASTM A 568 or ASTM A 569.

Structural quality zinc-coated (galvanized) steel sheet should comply with ASTM A 446 with G90 coating complying with ASTM A 525. Grade to suit manufacturer's standards. Galvanized bolts for structural framing should comply with ASTM A 307 or ASTM A 325 as necessary for design loads and connection details.

Structural steel should comply with the American Institute of Steel Construction's (AISC) "Specifications for the Design, Fabrication and Erection of Structural Steel for Buildings" for design requirements and allowable stresses.

Light gage steel should comply with the American Iron and Steel Institute's (AISI) "Specification for the Design of Cold Formed Steel Structural Members" and "Design of Light Gage Steel Diaphragms" for design requirements and allowable stresses.

Welded Connections should comply with the American Welding Society's (AWS) "Standard Code for Arc and Gas Welding in Building Construction" for welding procedures.

Paint and Coating Materials as recommended by the manufacturer.

Louvers

Refer to Section 08 91 00 - Metal Wall Louvers

Roll-up Doors

Refer to Section 08 34 19.10 20 - Rolling Service Doors

Swinging Doors

Doors to include a keyed lock. Lock to be keyed as directed by ENGINEER.

Minimum thicknesses

Roof Panels - 24 Gage

Wall Panels - 26 Gage

2.2 MANUFACTURERS

Ludwig Buildings Enterprises, LLC or an approved equal. Manufacturer shall have minimum 20 years of experience.

2.3 STRUCTURAL FRAMING AND ROOF AND SIDING PANELS

Design primary and secondary structural members and exterior covering materials for applicable loads and combinations of loads in accordance with the Metal Building Manufacturers Association's (MBMA) "Design Practices Manual."

Fabricate rigid frames from hot-rolled structural steel shapes. Furnish galvanized members. Provide factory-welded, hot-dipped galvanized, built-up "I-beam"-shape or open-web-type frames consisting of tapered or parallel flange beams and parallel flange columns. Furnish frames with attachment plates, bearing plates, and splice members. Factory drill for field-bolted assembly.

Provide hot-dipped galvanized finish on all rigid, primary, and secondary framing members.

Provide hot-dipped galvanized bolts except when structural framing components are in direct contact with roofing and siding panels. Provide zinc-plated or cadmium-plated bolts when structural framing components are in direct contact with roofing and siding panels. (Provide zinc plated bolts for structural framing components including washers and nuts where connecting items called to be galvanized; primary and secondary framing members.)

2.4 ANCHORAGE

Welded connection should be designed to resist the column reaction. The building manufacturer shall furnish welding details for connection of columns to the embedded anchor plate and provisions for leveling shall be included.

PART 3 EXECUTION

3.1 EXAMINATION

It shall be the responsibility of the CONTRACTOR that all fabricated materials meet the requirements of the accepted shop drawings and that they are true and straight. All materials shall be adequately protected from damage during delivery, storage, and installation.

Verification of Conditions: Examine areas and conditions under which work is to be performed and identify conditions detrimental to proper and or timely completion. Do not proceed until unsatisfactory conditions have been corrected.

3.2 PREPARATION

Each unit of hardware shall be individually packaged, complete with proper fastenings and all appurtenances and, as soon as feasible, submitted to the ENGINEER for approval.

3.3 INSTALLATION

Wall penetrations shall be identified prior to fabrication and made in shop. The CONTRACTOR shall install all material in strict accordance with the manufacturer's instructions. Care shall be used in assembling to avoid bumping, twisting, dropping, or otherwise damaging the materials. Doors, louvers, and all moving parts shall operate freely without binding or stopping and all edges shall fit closely.

The CONTRACTOR, where required by the contract documents or by the manufacturer, shall provide the services of an authorized representative of the manufacturer to perform the subject work, and all such work shall be in accordance with the manufacturer's printed recommendations and approved shop drawings. Service requests shall be answered and acted upon promptly.

-- End of Section --

DIVISION 23
HVAC

SECTION 23 31 13.00 40
DUCTWORK

INDEX

SECTION 23 31 13.00 40 - DUCTWORK

PART 1	GENERAL.....	2
1.1	SCOPE	2
1.2	REFERENCES	2
1.3	MEASUREMENT AND PAYMENT	3
1.4	SUBMITTALS	3
PART 2	PRODUCTS.....	4
2.1	SYSTEM DESCRIPTION	4
2.2	MATERIALS	4
2.2.1	Galvanized Steel Ductwork Materials.....	4
2.3	FABRICATION	4
2.4	FLEXIBLE CONNECTORS	4
2.5	EXHAUST LOUVERS	5
2.6	INSULATION	5
PART 3	EXECUTION.....	5
3.1	GENERAL INSTALLATION REQUIREMENTS	5
3.2	MANUFACTURER'S WARRANTY	5
3.3	DUCTWORK CLEANING PROVISIONS	5

SECTION 23 31 13.00 40

DUCTWORK

PART 1 GENERAL

1.1 SCOPE

This section covers the work necessary to design, furnish, and install metal and nonmetal ductwork to transport air from the radiator fan to the exhaust louvers mounted in the pump station walls.

1.2 REFERENCES

The publications listed below form a part of this specification to the extent referenced. The publications are referred to within the text by the basic designation only.

AMERICAN INSTITUTE OF STEEL CONSTRUCTION (AISC)

AISC 325 (2011) Steel Construction Manual

AISC 360 (2010) Specification for Structural Steel Buildings

AMERICAN SOCIETY OF HEATING, REFRIGERATING AND AIR-CONDITIONING ENGINEERS (ASHRAE)

ASHRAE EQUIP IP HDBK (2012) Handbook, HVAC Systems and Equipment (IP Edition)

ASHRAE FUN IP (2009; Errata 2010) Fundamentals Handbook, I-P Edition

AMERICAN WELDING SOCIETY (AWS)

AWS A5.8/A5.8M (2011) Specification for Filler Metals for Brazing and Braze Welding

ASTM INTERNATIONAL (ASTM)

ASTM A123/A123M (2012) Standard Specification for Zinc (Hot-Dip Galvanized) Coatings on Iron and Steel Products

ASTM A36/A36M (2008) Standard Specification for Carbon Structural Steel

ASTM A653/A653M (2011) Standard Specification for Steel Sheet, Zinc-Coated (Galvanized) or Zinc-Iron Alloy-Coated (Galvannealed) by the Hot-Dip Process

ASTM A924/A924M (2010a) Standard Specification for General Requirements for Steel Sheet, Metallic-Coated by the Hot-Dip Process

Franklin Canal Pump Station

ASTM D 3982 (2008) Standard Specification for Contact Molded "Fiberglass" (Glass Fiber Reinforced Thermosetting Resin) Ducts

National Fire Protection Association (NFPA)

NFPA 90A (2009) Standard for the Installation of Air-Conditioning and Ventilating Systems

SHEET METAL AND AIR CONDITIONING CONTRACTORS' NATIONAL ASSOCIATION (SMACNA)

SMACNA 1966 (2005) HVAC Duct Construction Standards Metal and Flexible, 3rd Edition

SMACNA 1987 (2006) HVAC Duct Systems Inspection Guide, 3rd Edition

SMACNA (1997) Thermoset FRP Duct Construction Manual; Sheet Metal and Air Conditioning CONTRACTORS' National Association

1.3 MEASUREMENT AND PAYMENT

No separate measurement or payment will be made for the material and work covered under this section. To be paid for within Bid Items: "Pump System."

1.4 SUBMITTALS

ENGINEER approval is required for submittals with a "E" designation; submittals not having a "E" designation are for information only. Submit the following:

SD-02 Shop Drawings

Connection Diagrams, E

SD-03 Product Data

Galvanized Steel Ductwork Materials; E

Flexible Connectors; E

Insulation; E

SD-05 Design Data

Design Analysis and Calculations; E

SD-06 Test Reports

Operational Tests; E

SD-07 Certificates

Listing of Product Installations; E

Franklin Canal Pump Station

Galvanized Steel Ductwork Materials; E

Flexible Connectors; E

PART 2 PRODUCTS

2.1 SYSTEM DESCRIPTION

Provide low-pressure systems ductwork with maximum air velocity and static pressure not to exceed that specified by radiator supplier.

Submit [connection diagrams](#) for low pressure ductwork systems indicating the relation and connection of devices and apparatus by showing the general physical layout of all controls, the interconnection of one system (or portion of system) with another, and internal tubing, wiring, and other devices.

Submit [design analysis and calculations](#) for low pressure ductwork systems indicating the manufacturer's recommended air velocities, maximum static pressures, temperature calculations and acoustic levels.

2.2 MATERIALS

2.2.1 Galvanized Steel Ductwork Materials

Provide hot-dip galvanized carbon steel ductwork sheet metal of lock-forming quality, with regular spangle-type zinc coating, conforming to [ASTM A924/A924M](#) and [ASTM A653/A653M](#), Designation G90. Treat duct surfaces to be painted by apostatizing.

Conform to [ASHRAE EQUIP IP HDBK](#), Chapter 16, [ASHRAE FUN IP](#), Chapter 32 and [SMACNA 1966](#) for sheet metal [thickness gages](#) and reinforcement thickness.

Low pressure ductwork minimum standards are:

MINIMUM SHEET METAL GAGE

<u>DUCT WIDTH</u> <u>INCHES</u>	<u>GAGE</u>
0 - 12	26
13 - 30	24
31 - 60	22

2.3 FABRICATION

Fabricate and support in accordance with applicable SMACNA duct standard. Provide duct material, gages, reinforcing, and sealing for operating pressures indicated. Change duct sizes gradually, not exceeding 15 degrees divergence wherever possible; maximum 30 degrees convergence. Fabricate duct fittings in accordance with applicable SMACNA duct standard.

2.4 FLEXIBLE CONNECTORS

Furnish flexible connectors at each radiator connection to accommodate movement. Material for the connection shall be wire-reinforced fiberglass.

Franklin Canal Pump Station

The connection shall be airtight.

2.5 EXHAUST LOUVERS

Size to be coordinated with pump manufacturer.

Louvers shall be 6 inch deep, 0.11" minimum thickness galvanized steel blades on 37° to 45° slope, 0.125" thick galvanized steel frame material, 1/2 inch opening expanded aluminum screen on interior.

2.6 INSULATION

Exhaust system shall be wrapped with fully faced and fitted insulation.

PART 3 EXECUTION

3.1 GENERAL INSTALLATION REQUIREMENTS

Install, support, and seal ducts in accordance with applicable SMACNA duct construction standard. Install in accordance with manufacturer's instructions. CONTRACTOR shall fabricate duct to smoothly match equipment connections and existing duct sizes. Locate ducts with sufficient space around equipment to allow normal operating and maintenance activities.

Fabricate airtight and include reinforcements, bracing, supports, framing, gasketing, sealing, and fastening to provide rigid construction and freedom from vibration, airflow-induced motion and noise, and excessive deflection at specified maximum system air pressure and velocity.

Sheet metal minimum thickness, joints, and reinforcement between joints shall be in accordance with [ASHRAE EQUIP IP HDBK](#), Chapter 16, [ASHRAE FUN IP](#), Chapter 32 and [SMACNA 1966](#).

Where the shape of a duct changes, ensure the angle of the side of the transition piece does not exceed 15 degrees from the straight run of duct connected thereto.

3.2 MANUFACTURER'S WARRANTY

Submit original and two copies of manufacturer's signed Warranty.

3.3 DUCTWORK CLEANING PROVISIONS

Protect open ducting from construction dust and debris in a manner approved by the ENGINEER. Clean dirty assembled ducting by subjecting all main and branch interior surfaces to airstreams moving at velocities two times specified working velocities, at static pressures within maximum ratings. This may be accomplished by: filter-equipped portable blowers which remain the CONTRACTOR's property; wheel-mounted, compressed-air operated perimeter lances which direct the compressed air and which are pulled in the direction of normal airflow; or other means approved by the ENGINEER. Use water- and oil- free compressed air for cleaning ducting. After construction is complete, and prior to acceptance of the work, remove construction dust and debris from exterior surfaces.

-- End of Section --

DIVISION 26
ELECTRICAL

SECTION 26 00 00.00 20
ELECTRICAL GENERAL

INDEX

SECTION 26 00 00.00 20 - ELECTRICAL GENERAL

PART 1	GENERAL	2
PART 2	PRODUCTS	5
PART 3	EXECUTION	7



08/05/13
REV. 0

SECTION 26 00 00.00 20
ELECTRICAL GENERAL

PART 1 GENERAL

1.1 SCOPE

The work covered by this section consists of providing all labor, equipment, and materials and performing all operations necessary for the installation of the electrical work as herein called for and shown on the Contract Drawings. The work shall include, but shall not be limited to, the following:

- A. Provide all electrical equipment, devices and labor required to make a complete electrical distribution system as called for on the contract drawings and specifications.
- B. Provide all grounding and bonding as indicated on the drawings and as required by NEC.
- C. The above list is a general description and should not be considered inclusive of all efforts required by the electrical contractor. Unless specifically stated, the contractor is responsible for all material and labor required to make a complete and properly functioning system.

1.1.1 Related Documents:

- A. Drawings and general provisions of the Contract, including General and Supplementary Conditions, apply to work of this Section.
- B. Provisions of this Section apply to work of all Electrical Sections.
- C. Review all project drawings to be aware of conditions affecting work herein.

1.2 REFERENCES

- A. All work under Section 26 shall be constructed in accordance with the latest editions of all relevant codes and standards listed herein. The design has been based on the requirements of these codes and standards. While it is not the responsibility of the Contractor to verify that all work called for complies with these codes and standards, he shall be responsible for calling to the Engineer's attention any details on the Drawings and/or Specifications that are not in conformance with these or other codes and standards. Current issue of code applies unless specifically noted otherwise.
- B. Comply with regulations and codes of suppliers of utilities.
- C. Where no specific method or form of construction is called for in the Contract Documents, the Contractor shall comply with code requirements when carrying out such work.
- D. Where code conflict exists, generally the most stringent requirement applies.
- E. Codes or standards applying to a specific part of the work may be included in that section.

Franklin Canal Pump Station

- F. Codes:
- 1) Standard Building Code
 - 2) National Electrical Code (NEC)
 - 3) National Electrical Safety Code (NESC)
 - 4) Life Safety Code (NFPA 101)
- G. Standards: All electrical materials, installation, and systems shall meet the requirements of the following standards, including the latest addenda and amendments:
- 1) American National Standard Institutes (ANSI)
 - 2) Institute of Electrical and Electronics Engineers (IEEE).
 - 3) National Electrical Manufacturer's Associations (NEMA).
 - 4) National Fire Protection Association (NFPA).
 - 5) Occupational Safety and Health Act (OSHA).
 - 6) Underwriter's Laboratories, Inc. (UL).

1.3 MEASUREMENT AND PAYMENT

1.3.1 Measurement

Measurement shall be on a lump sum basis.

1.3.2 Payment

Payment for providing and installing the entire electrical system per the drawings and specifications will be made under Bid Item "Electrical Service and Amenities".

1.4 SUBMITTALS

- A. Before ordering any materials or equipment, and within 30 days after the award of Contract, the Contractor shall submit to the Engineer one complete schedule showing the make, type, manufacturer's name, and trade designation of all equipment.
- 1) This schedule shall be accompanied by six (6) copies of the manufacturer's printed specifications and shop drawings for each piece of equipment or specialty and shall give dimensions, diagrams, descriptive literature, capacity or rating, kind of material, finish, guarantee, etc., and such other detailed information as the Engineer may require.
 - 2) When approved, such schedule shall be an addition to these Specifications, and shall be of equal force in that no deviation will be permitted except with the approval of the Engineer.
- B. If shop drawings show variation from the requirements of the Contract Documents, the Contractor shall make specific mention of such variation in his letter of transmittal. If acceptable, Contractor will not be relieved of the responsibility for executing the work in accordance with the Contract.
- C. Review of shop drawings, descriptive literature, catalog data, or schedules by the Engineer shall not relieve the Contractor from responsibility for deviations from Contract Drawings or Specifications, unless he has in writing called to the attention of the Engineer such deviation at the time of submission, nor shall it relieve him from responsibility for errors of any sort in shop drawings, descriptive literature, catalog data, or schedules.
- D. Submit shop drawings and any other drawings specifically called for in other sections. Shop drawings shall consist of plans, sections, elevations, and details to scale (not smaller than ¼"

Franklin Canal Pump Station

per foot), with dimensions clearly showing the installation. Direct copies of small scale project drawings issued to the Contractor are not acceptable. Drawings shall take into account equipment furnished under other Sections and shall show space allotted for it. Include construction details and materials.

- E. Submit product data after award of the Contract and before any equipment or materials are purchased. Product data is defined as manufacturer's printed literature specifically marked to indicate size and model and accompanied by rating sheets listing values showing that equipment meets scheduled or specified values. Properly coded stamp from the Engineer on returned submittal is required before ordering equipment.

1.5 DEFINITIONS

- A. Provide: Furnish, install, and test, complete and ready for intended use.
- B. Furnish: Supply and deliver to project site, ready for subsequent requirements.
- C. Install: Operations at project site, including unloading, unpacking, assembly, erection, placing, anchoring, applying, working to dimension, finishing, curing, protecting, cleaning, and similar requirements.

- 1.6 Permits and Fees: Contractor shall obtain all necessary permits, meters, and inspections required for his work and pay all fees and charges incidental thereto.

- 1.7 Verification of Owner's Survey Data: Prior to commencing any excavation or grading, the Contractor shall satisfy himself as to the accuracy of all survey data indicated on the Drawings and/or provided by the Owner. Should the Contractor discover any inaccuracies, errors, or omissions in the survey data, he shall immediately notify the Engineer. Commencement by the Contractor of any excavation or upgrading shall be held as an acceptance of the survey data by him after which time the Contractor has no claim against the Owner resulting from alleged errors, omissions, or inaccuracies of the said survey data.

- 1.8 Delivery and Storage of Materials: Materials delivered to site shall be inspected for damage, unloaded, and stored with a minimum of handling. All material shall be stored to provide protection from the weather and accidental damage. Any damage to material shall be the responsibility of the contractor to coordinate with the supplier for replacement and/or repair.

- 1.9 Extent of work is indicated in the Drawings, Schedules, and Specification. Singular references shall not be construed as requiring only one device if multiple devices are shown on the Drawings or are required for proper system operation.

1.10 Field Measurements and Coordination:

- A. The intent of the Drawings and Specifications is to obtain a complete and satisfactory installation. Separate divisional Drawings and Specifications shall not relieve the Contractor or Subcontractors from full compliance of work of his trade indicated on any of the Drawings or in any Section of the Specifications. Report conflicts prior to start of work.

Franklin Canal Pump Station

- B. Verify all field dimensions and locations of equipment to insure close, neat fit with other trades' work. Make use of all Contract Documents and approved shop drawings to verify exact dimension and locations. Do not scale electrical drawings; rely on dimensions shown on architectural or structural drawings.
- C. Coordinate work in this Division with all other trades in proper sequence to insure that the total work is completed within Contract time schedule and with minimum cutting and patching.
- D. Locate all equipment, materials, and apparatus symmetrical with architectural elements. Install to exact height and locations when shown on architectural drawings. When locations are shown only on mechanical drawings, be guided by structural details and conditions existing at job and correlate this work with that of others.
- E. Install work as required to fit structure, avoid obstructions, and retain clearance, headroom, openings, and passageways. Cut no structural members without written approval from Engineer.
- F. Carefully examine any existing conditions, piping, and premises. Compare Drawings with existing conditions. Report any observed discrepancies. Written instructions will be issued by the Engineer to resolve discrepancies.
- G. Because of the small scale of the Drawings, it is not possible to indicate all offsets and fittings or to locate every accessory. Drawings are essentially diagrammatic. Study carefully the sizes and locations of structural members, wall and partition locations, trusses, and room dimensions and take actual measurements on the job. Locate material, equipment, and accessories with sufficient space for installing and servicing. Contractor is responsible for accuracy of his measurements and shall not order materials or perform work without verification. No extra compensation will be allowed because field measurements vary from the dimensions on the Drawings. If field measurements show that equipment or material cannot be fitted, the Engineer shall be consulted. Remove and relocate, without additional compensation, any item that is installed and is later found to encroach on space assigned to another use.

1.11 Guarantee and Service:

- A. The Contractor shall guarantee labor, materials, and equipment for a period of one (1) year from Substantial Completion, or from Owner's occupancy, whichever is earlier (this is a minimum unless stated otherwise). Contractor shall make good any defects and shall include all necessary adjustments to and replacement of defective items without expense to the Owner.
- B. In addition to the manufacturer's guarantee of each item, Contractor shall provide his standard guarantee after final acceptance and make good any defects of materials or workmanship occurring during this period without expense to the Owner.
- C. Owner reserves the right to make emergency repairs as required to keep equipment in operation without voiding Contractor's Guarantee Bond nor relieving Contractor of his responsibilities during guarantee period.

PART 2 PRODUCTS

Franklin Canal Pump Station

2.1 All materials shall be new and unused, Owner-supplied, or reused as shown on the Drawings, the best of their respective kinds, suitable for the conditions and duties imposed on them. The description, characteristics, and requirements of materials to be used shall be in accordance with qualifying conditions established in the following Sections.

2.2 Equipment and Materials:

- A. Equipment and materials furnished under this Section shall be the product of a manufacturer regularly engaged in the manufacture of such items for a period of three years. Where practical, all of the components shall be products of a single manufacturer in order to provide proper coordination and responsibility. Where required, Contractor shall furnish proof of installation of similar equipment or materials.
- B. Each item of equipment shall bear a nameplate showing the manufacturer's name, trade name, model number, serial number, ratings and other information necessary to fully identify it. This plate shall be permanently mounted in a prominent location and shall not be concealed, insulated, or painted.
- C. The label of the approving agency, such as UL or NEMA, by which a standard has been established for the particular item, shall be in full view. Materials shall be UL-listed for the application specified or indicated on the Drawings or Specifications.
- D. All electrical equipment, such as switchboards, panelboards, industrial control panels, meter socket enclosures, motor control centers, or other similar devices or equipment shall be field marked per NEC 2011, Article 110.16 to warn qualified personnel of potential electrical arc flash hazards. Labels shall be Brady Cat # 94913 or equal.
- E. Materials and equipment are specified herein by a single or by multiple manufacturers to indicate quality, material, and type of construction desired. Manufacturer's products shown on the Drawings have been used as basis for design; it shall be the Contractor's responsibility to ascertain that alternate manufacturer's products meet detailed specifications and that size and arrangement of equipment are suitable for installation.

2.3 Requests for Substitution:

- A. Where a particular system, product or material is specified by name, consider it as standard basis for bidding, and base proposal on the particular system, product, or material specified. Other systems, products, equipment or materials may be accepted only if, in the opinion of the Engineer, they are equivalent in quality and workmanship and will perform satisfactorily its intended purpose. All such substitutions in materials or equipment shall be approved in writing by the Engineer.
- B. In making requests for substitutions, the Contractor shall list the particular system, product, equipment, or material he wishes to substitute and at bid time the Contractor shall state the amount he will add or deduct from his base bid if the substitution is approved by the Engineer. If no deduction or addition to the base bid is allowed by the Contractor for such substitution, it shall be so stated on the request.
- C. Requests by Contractor for substitution will be considered only

Franklin Canal Pump Station

when reasonable, timely, fully documented, and qualifying under one or more of the following circumstances.

- 1) Required product cannot be supplied in time for compliance with Contract time requirements.
- 2) Required product is not acceptable to governing authority, or determined to be non-compatible, or cannot be properly coordinated, warranted or insured, or has other recognized disability as certified by Contractor.
- 3) Substantial cost advantage is offered Owner after deducting off-setting disadvantages including delays, additional compensation for redesign, investigation, evaluation, and other necessary services and similar considerations.

D. All requests for substitution shall contain a "Comparison Schedule" and clearly and specifically indicate any and all differences or omissions between the product specified as the basis of design and the product proposed for substitution. Differences shall include, but shall not be limited to, data as follows for both the specified and substituted products:

- 1) Principle of operation.
- 2) Materials of construction or finishes.
- 3) Thickness of materials.
- 4) Weight of item.
- 5) Deleted features or items.
- 6) Added features or items.
- 7) Changes in other work caused by the substitution.
- 8) Performance and rating data.
- 9) If the approved substitution contains differences or omissions not specifically called to the attention of the Engineer, the Owner reserves the right to require equal or similar features to be added to the substituted products at the Contractor's expense.

2.4 Prior Approval: Where the term "or approved equal" is used in the Drawings or the Specifications, submit all requests and clearly indicate all differences between the specified and proposed product following the guidelines for substitution herein. The Engineer may, at his discretion, approve items not pre-approved if he feels that it is in the best interest of the Owner and the item meets the quality and project requirements.

PART 3 EXECUTION

3.1 Workmanship: All materials, fixtures, and equipment shall be installed and completed in a first-class workmanlike manner and in accordance with the best modern methods and practice. Any materials installed which do not present an orderly and reasonably neat and/or workmanlike appearance, or do not allow adequate space for maintenance, shall be removed and replaced when so directed by the Engineer.

3.2 Coordination:

- A. The Contractor shall be responsible for full coordination of the electrical systems with shop drawings of the building/installation construction so the proper openings and sleeves or supports etc., are provided for conduit, devices, or other equipment passing through slabs or walls.
- B. Any additional steel supports required for the installation of

Franklin Canal Pump Station

- any electrical equipment, etc., shall be provided by the Contractor.
- C. It shall be the Contractor's responsibility to see that all equipment that may require maintenance and operation are made easily accessible, regardless of the diagrammatic location shown on the Drawings.
 - D. All connections to fixtures and equipment shown on the Drawings shall be considered diagrammatic unless otherwise indicated by a specific detail on the Drawings. The actual connections shall be made to fully suit the requirements of each case and adequately provide for servicing.
 - E. The Contractor shall protect equipment and fixtures at all times during storage and construction. He shall replace all equipment and fixtures which are damaged as a result of inadequate protection.
 - F. Prior to starting and during progress of work, examine work and materials installed by others as they apply to work in this Section. Report conditions which will prevent satisfactory installation.
 - G. Start of work will be construed as acceptance of suitability of work of others.
- 3.3 Utilities Coordination: When required, the Contractor shall meet with respective personnel of the telephone and electric utilities and review all details of the service and distribution. All details shown on contract documents shall be verified for adequacy and accuracy. The Contractor shall incorporate any required revisions without additional cost to the Owner.
- 3.4 Construction Electrical Utilities: Provide all temporary wiring for power and light required for construction purposes and remove such temporary wiring when use is no longer required.
- 3.5 Interruption of Service: Before any equipment is shut down for disconnecting or tie-ins, arrangements shall be made with the Engineer and this work shall be done at the time best suited to the Owner. Outages must be scheduled through the Engineer. Extent, length, and timing of outages shall be reviewed by the Engineer. Outages shall be minimized as much as possible to allow normal site operation as much as possible. Provide temporary power or other services as required during outages.
- 3.6 Cutting and Patching: Contractor shall be responsible for cutting and patching of all holes, chases, sleeves, and other openings required for installation of equipment furnished and installed under these Specifications. Obtain permission from Engineer before cutting any structural items.
- 3.7 Equipment Setting: Bolt equipment directly to concrete pads or foundations, using hot-dipped galvanized anchor bolts, nuts, and washers. Contractor is responsible for leveling installed equipment.
- 3.8 Painting: Touch-up factory finishes on equipment located inside and outside shall be done in accordance with these specifications. The contractor shall obtain matched color coatings from the manufacturer and apply as directed by manufacturer. If corrosion is found during inspection on the surface of any equipment, clean, prime, and paint as required.
- 3.9 Clean-up: Thoroughly clean all exposed parts of apparatus and

Franklin Canal Pump Station

equipment of cement, plaster, and other materials and remove all oil and grease spots. Repaint or touch up as required to look like new.

During progress of work, Contractor is to carefully clean and leave premises free from debris and in a safe condition.

3.10 Start-up and Operational Test: Start each item of equipment in strict accordance with the manufacturer's instructions; or where noted under equipment specification, start-up shall be done by a qualified representative of the manufacturer at the expense of the Contractor. Alignment, lubrication, safety, and operating control shall be included in start-up check.

3.11 Record Drawings:

- A. During the progress of the work the Contractor shall record on their field set of Drawings the corrections, variations, and deviations for systems which are not installed exactly as shown on the Contract Drawings.
- B. Upon completion of the work, record drawings shall be prepared as described in these Electrical Specifications, the General Conditions, and any Supplementary Conditions.

3.12 Acceptance:

- A. Request inspections as required under the Supplementary or General Conditions. Conceal no work until inspected. It is the Contractors responsibility to document that all inspections are conducted in accordance with these specifications.
- B. Punch List: Submit written confirmation that all punch lists have been checked and the required work completed.
- C. For existing electrical systems, the contractor shall verify electrical phase rotation prior to disconnecting equipment to ensure that new system will have same phase rotation. Test together and separately to determine that:
 - 1) System is free from short circuits and other faults.
 - 2) Motor starter overload devices are sized correctly.
 - 3) Motors rotate correctly.
 - 4) All equipment operates correctly and as specified.
 - 5) All relaying set and tested.
- D. Instructions: At completion of the work, provide a competent and experienced person who is thoroughly familiar with the project, for a period deemed necessary by the Owner to instruct permanent operating personnel in the operation of equipment and control systems.
- E. Operation and Maintenance Manuals: Furnish four complete manuals for all new equipment bound in ring binders and organized by system or section. Manuals shall contain:
 - 1) Detailed operating instructions and instructions for making minor adjustments.
 - 2) Complete wiring and control diagrams.
 - 3) Routine maintenance operations.
 - 4) Manufacturer's catalog data, service instructions, and parts list for each piece of operating equipment.
- F. Warranties: Submit copies of all manufacturers' warranties.
- G. Record Drawings: Submit "Record Drawings".
- H. Install engraved metal or plastic nameplates or tags on controls, panels, switches, starters, timers, and similar operable equipment, keyed by number to operating instructions. Dymo type labels are not acceptable.
- I. Acceptance will be on the basis of tests and inspections of the

Franklin Canal Pump Station

work. A representative of the firm which performed the testing shall be in attendance to assist during inspection. Contractor shall furnish necessary electricians to operate system, make any necessary adjustments and assist with final inspection.

SECTION 26 05 53.00 40
CONDUCTORS AND CABLE IDENTIFICATION

INDEX

SECTION 26 05 53.00 40 - CONDUCTOR AND CABLE IDENTIFICATION

PART 1	GENERAL	2
PART 2	PRODUCTS	2
PART 3	EXECUTION	2

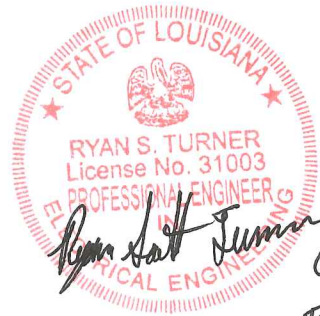

08/05/13
REV. 0

Franklin Canal Pump Station

SECTION 26 05 53.00 40
CONDUCTOR AND CABLE IDENTIFICATION

PART 1 GENERAL

1.1 SCOPE

This Section provides the requirements for identification of grounded conductors (neutral), grounding conductors, ungrounded conductors, and terminals.

1.2 REFERENCES

Not used.

1.3 MEASUREMENT AND PAYMENT

No separate measurement or payment will be made for the material and work covered under this section.

1.4 SUBMITTALS

Not used.

1.5 RELATED DOCUMENTS

Drawings and general provisions of Contract, including General and Supplementary Conditions, apply to the work of this Section.

PART 2 PRODUCTS

2.1 Comply with the Section 26 00 00.00 20, "Electrical General".

PART 3 EXECUTION

3.1 Identification of conductors shall follow the colors set forth herein for the electrical characteristics as indicated:

A. 120/240 Volt, Single Phase, 3 Wire

- 1) Neutral: White or Gray
- 2) Line 1: Black
- 3) Line 2: Red
- 4) Grounding Conductor: Green

B. 120/208 Volt, Three Phase, 4 Wire WYE

- 1) Neutral: White or Gray
- 2) Phase A: Black
- 3) Phase B: Red
- 4) Phase C: Blue
- 5) Grounding Conductor: Green

Franklin Canal Pump Station

C. 277/480 Volt, Three Phase, 4 Wire WYE

- 1) Neutral: White or Gray with Stripe (tracer)
 - 2) Phase A: Brown
 - 3) Phase B: Orange
 - 4) Phase C: Yellow
 - 5) Grounding Conductor: Green with Stripe (tracer)
- 3.2 Communication, temperature control, and fire alarm conductors shall be color coded or permanently tagged for identification. The colors shall not include white, gray, or green base colors or stripes (tracers) unless these colors are used as grounded conductors or grounding conductors.
- 3.3 Colors shall comply with the Insulated Cable Engineers Association (ICEA) Method K-2 chart.
- 3.4 For direct current (DC) systems, black shall be negative and red shall be positive.
- 3.5 A single color conductor other than white, gray, or green may be used when the conductors are identified with number tags or numbered wire.
- 3.6 Identification shall be provided at terminations of the conductors and at junction boxes, terminals, or cabinets when multi-conductors are installed at these locations.
- 3.7 Grounded Conductor (neutral): Size No. 6 AWG or smaller, shall be identified by a continuous white or natural gray outer finish along its entire length. Sizes larger than No. 6 AWG shall be identified either by a continuous white or natural gray outer finish along its entire length or at the time of installation by a distinctive white or gray marking at its terminations.
- 3.8 A continuous white or natural gray covering on a conductor or a termination marking of white or natural gray color shall be used only for the grounded conductor (neutral).
- 3.9 Terminals to which a grounded conductor is to be connected shall be substantially white in color or identified by white markings. Other terminals shall be a different, readily distinguishable color, or by markings in different, readily distinguishable colors.
- 3.10 Grounding Conductor: Size No. 6 AWG or smaller shall be identified by a continuous green outer finish along its entire length. Sizes larger than No. 6 AWG shall be identified either by a continuous green outer finish along its entire length or at the time of installation by a distinctive green marking at its termination.
- 3.11 Terminals to which grounding conductors are connected shall be green in color.
- 3.12 A continuous green covering on a conductor or a termination marking of green shall be used only for the grounding conductor.

SECTION 26 24 16.00 40
PANELBOARDS

INDEX

SECTION 26 24 16.00 40 - PANELBOARDS

PART 1	GENERAL	2
PART 2	PRODUCTS	3
PART 3	EXECUTION	4



Ryan S. Turner
08/05/13
REV. 0

SECTION 26 24 16.00 40
PANELBOARDS

PART 1 GENERAL

1.1 SCOPE

The Contractor shall furnish and install a panelboard as specified and as shown on the contract drawings.

1.2 REFERENCES

The panelboards and all components shall be designed, manufactured and tested in accordance with the latest applicable standards of NEMA and UL as follows:

- A. UL 67 - Panelboards
- B. UL 50 - Cabinets and boxes
- C. NEMA PB1
- D. Fed. Spec. W-P-115C
- E. Circuit breaker - Type I class I
- F. Fusible switch - Type II class I

1.3 MEASUREMENT AND PAYMENT

No separate measurement or payment will be made for the material and work covered under this section.

1.4 SUBMITTALS

The following information shall be submitted to the Engineer:

- A. Conduit entry/exit locations
- B. Assembly ratings including:
 - Short-circuit rating
 - Voltage
 - Continuous current
 - Cable terminal sizes
 - Product data sheets

1.5 QUALIFICATIONS

- A. The manufacturer of the assembly shall be the manufacturer of the major components within the assembly.
- B. For the equipment specified herein, the manufacturer shall be ISO 9001 or 9002 certified.
- C. The manufacturer of this equipment shall have produced similar electrical equipment for a minimum period of five (5) years. When requested by the Engineer, an acceptable list of installations with similar equipment shall be provided demonstrating compliance with this requirement.
- D. Regulatory Requirements: The panelboards shall be UL labeled.

Franklin Canal Pump Station

1.6 DELIVERY, STORAGE, AND HANDLING

Equipment shall be handled and stored in accordance with manufacturer's instructions. One (1) copy of these instructions shall be included with the equipment at time of shipment.

1.7 OPERATION AND MAINTENANCE MANUALS

Equipment operation and maintenance manuals shall be provided with each assembly shipped and shall include instruction leaflets, instruction bulletins and renewal parts lists where applicable, for the complete assembly and each major component.

PART 2 PRODUCTS

2.1 MANUFACTURERS

- A. Eaton / Cutler-Hammer products
- B. General Electric
- C. Square-D
- D. Siemens
- E. Crouse-Hinds
- F. The listing of specific manufacturers above does not imply acceptance of their products that do not meet the specified ratings, features and functions. Manufacturers listed above are not relieved from meeting these specifications in their entirety.

2.2 RATING

- A. Panelboards rated 240 Vac or less shall have short-circuit ratings as shown on the drawings or as herein scheduled, but not less than 10,000 amperes RMS symmetrical.
- B. Panelboards shall be labeled with a UL short-circuit rating. When series ratings are applied with integral or remote upstream devices, a label or manual shall be provided. It shall state the conditions of the UL series ratings including:
 - 1) Size and type of upstream device
 - 2) Branch devices that can be used
 - 3) UL series short-circuit rating

2.3 CONSTRUCTION

- A. Interiors shall be completely factory assembled. They shall be designed such that switching and protective devices can be replaced without disturbing adjacent units and without removing the main bus connectors.
- B. Distribution panelboard trims shall cover all live parts. Switching device handles shall be accessible.
- C. A directory card with a clear plastic cover shall be supplied and mounted on the inside of each door.
- D. All locks shall be keyed alike.

2.4 BUS

- A. Main bus bars shall be copper, sized in accordance with UL

Franklin Canal Pump Station

standards to limit temperature rise on any current carrying part to a maximum of 65 degrees C above an ambient of 40 degrees C maximum.

- B. A system ground bus shall be included in all panels.
- C. Full-size (100%-rated) insulated neutral bars shall be included for panelboards shown with neutral. Bus bar taps for panels with single-pole branches shall be arranged for sequence phasing of the branch circuit devices. Neutral busing shall have a suitable lug for each outgoing feeder requiring a neutral connection. 200%-rated neutrals shall be supplied for panels designated on drawings with oversized neutral conductors.

2.5 NAMEPLATES

Provide an engraved laminated phenolic nameplate 1" high by 3" wide with minimum 1/4" letters indicating the panelboard identification. The panelboard shall also have a nameplate affixed to the panelboard with the following information stamped therein:

- A. Manufacturer,
- B. Voltage,
- C. Ampacity,
- D. Type of Panelboard,
- E. Manufacturer's Order No. and Date,
- F. Interrupting Rating - RMS Sym.

2.6 FINISH

Surfaces of the trim assembly shall be properly cleaned, primed, and a finish coat of gray ANSI 61 paint applied.

PART 3 EXECUTION

- 3.1 Factory Testing: Standard factory tests shall be performed on the equipment provided under this section. All tests shall be in accordance with the latest version of NEMA and UL standards.
- 3.2 Installation: The Contractors shall install all equipment per the manufacturer's recommendations and the contract drawings.
- 3.3 Provide circuit breakers with I.C. ratings, amperes and number of poles as specified in the schedules on the Drawings.
- 3.4 Provide a typewritten circuit directory with a protective covering in a frame inside the door. The directory shall indicate load served by each circuit. Directories shall also indicate source of service to panelboards. Example: "Panel PA served from Panel MDP."

**DIVISION 31
EARTHWORK**

SECTION 31 05 19.02 12
GEOTEXTILE SEPARATOR

INDEX

SECTION 31 05 19.02 12 - GEOTEXTILE SEPARATOR

PART 1 GENERAL..... 2
1.1 SCOPE2
1.2 REFERENCES2
1.3 MEASUREMENT AND PAYMENT2
1.4 SUBMITTALS2
1.5 SHIPMENT AND STORAGE3
PART 2 PRODUCTS..... 3
2.1 GEOTEXTILE REQUIREMENTS3
2.2 THREAD4
PART 3 EXECUTION..... 4
3.1 GEOTEXTILE INSTALLATION4
3.2 ROLL WIDTHS5
3.3 SEAMS AND OVERLAPS5

SECTION 31 05 19.02 12

GEOTEXTILE SEPARATOR UNDER WATER

PART 1 GENERAL

1.1 SCOPE

The work provided for herein consists of furnishing all plant, labor, material, equipment and performing all operations required for furnishing, hauling, and placing geotextile used as a permeable separator to prevent mixing of dissimilar materials between the limestone surface course and the existing soil, complete, as specified herein and on the contract drawings, and maintaining the geotextile until placement of the stone cover is completed and accepted.

1.2 REFERENCES

The publications listed below form a part of this specification to the extent referenced. The publications are referred to within the text by the basic designation only.

ASTM INTERNATIONAL (ASTM)

ASTM D 883	(2000) Terminology Relating to Plastics
ASTM D 4491	(1999; R 2004e1) Water Permeability of Geotextiles by Permittivity
ASTM D 4632	(1991; R 2003) Standard Test Method for Grab Breaking Load and Elongation of Geotextiles
ASTM D 4751	(2004) Determining Apparent Opening Size of a Geotextile
ASTM D 4884	(1996; R 2003) Strength of Sewn or Thermally Bonded Seams of Geotextiles

1.3 MEASUREMENT AND PAYMENT

Geotextile will be measured in place to the nearest square yard of protected area as delineated in the drawings for Base Bid and Alternate 1. Payment will be made at the contract unit price for Bid Items: "Geotextile Separator." Price and payment shall constitute full compensation for providing all plant, labor, material, and equipment and performing all operations necessary for the complete and satisfactory installation of the geotextile. No payment shall be made for geotextile that is rejected or damaged due to CONTRACTOR fault or negligence.

1.4 SUBMITTALS

ENGINEER approval is required for submittals with an "E" designation; submittals not having an "E" designation are for information only.

SD-04 Samples

Geotextile

At least 30 days prior to installation, the CONTRACTOR shall furnish a 5-foot by 5-foot sample of each geotextile that the CONTRACTOR plans to use shall accompany the certificate. If seams are used, then an additional 5-foot by 5-foot sample containing a sample seam in the center of the geotextile sample shall be submitted with the certificate.

SD-07 Certificates

Geotextile

Geotextile and seams used in construction will be accepted on the following basis. At least 30 days prior to installation, the CONTRACTOR shall furnish to the ENGINEER, in duplicate, a mill certificate or affidavit signed by a legally authorized official from the company manufacturing the geotextile. The certificate shall contain the signer's title, the name and address of the CONTRACTOR, the contract number, and the project name and location. The mill certificate or affidavit shall attest that the geotextile meets the chemical, physical, and manufacturing requirements stated in this specification and that the seams used meet the seam requirements.

1.5 SHIPMENT AND STORAGE

The geotextile shall be shipped and maintained in a heavy-duty protective cover until it is placed. During all periods of shipment and storage, the geotextile shall be protected from direct sunlight, ultra violet rays, temperatures greater than 140 degrees Fahrenheit, mud, dirt, and other contaminants.

PART 2 PRODUCTS

2.1 GEOTEXTILE REQUIREMENTS

The geotextile shall be a woven pervious sheet made with plastic yarn as defined by ASTM D 883. The geotextile shall meet the physical requirements listed in Table No. 1. The geotextile fiber shall consist of a long-chain synthetic polymer composed of at least 85 percent by weight of propylene, ethylene, ester, amide, or vinylidene chloride, and shall contain stabilizers and/or inhibitors added to the base plastic, if necessary, to make the filaments resistant to deterioration due to ultraviolet exposure. The edges of the geotextile shall be selvaged.

TABLE 1
PHYSICAL REQUIREMENTS FOR GEOTEXTILE SEPARATOR

Property	Units	Value	Test Method
Grab Tensile Strength	lbs.	150	ASTM D-4632
Grab Elongation	%	50	ASTM D-4632
Puncture Strength	lbs.	85	ASTM D-4833
Mullen Burst	psi	280	ASTM D-3786
Trapezoidal Tear	lbs.	60	ASTM D-4533
Apparent Opening Size	US standard sieve	80	ASTM D-4751
Permittivity	sec ⁻¹	1.4	ASTM D-4491
Water Flow Rate	gpm/ft ²	110	ASTM D-4491
UV Resistance (% retained after 500 hours)	%	70	ASTM D-4355

2.2 THREAD

Sewn seams shall be constructed with high-strength polyester, nylon, or other approved thread type. Thread shall have ultraviolet light stability equivalent to the geotextile and the color shall contrast with the geotextile.

PART 3 EXECUTION

3.1 GEOTEXTILE INSTALLATION

The geotextile shall be placed as shown on the drawings. Geotextile shall be placed on a smooth soil foundation free from ruts, holes, or sharp objects that may puncture, sever or damage the geotextile. Any shell, crushed stone or other road base material shall be removed until a firm soil base is established to place the geotextile on. All wrinkles and sags shall be stretched out immediately before the surfacing material is placed on the geotextile. At the time of installation, the geotextile shall be rejected if it has defects, rips, holes, flaws, deterioration or damage that was incurred during manufacture, transportation or storage. The geotextile shall be protected at all times during construction to insure that the geotextile's original chemical and physical properties are not changed. Geotextile pieces shall be joined using any approved method from paragraphs 3.3 and 3.4. The required overlap shall be maintained at all alignment offset changes and survey PI's. Except for rubber tire vehicles, mechanical equipment will not be permitted to operate directly on the geotextile surface, but may operate on the layer of material above the geotextile, as long as the thickness of this layer is greater than or equal to the specified thickness. Any ruts that develop after placement of the geotextile and surface material shall not be graded out, but shall be filled in with additional surface material. The geotextile shall be secured with adequate anchoring at the end of any work period. The CONTRACTOR shall take

appropriate action to ensure that the geotextile is not exposed to field conditions for more than a total of 2 calendar weeks. Failure to comply shall require replacement of the exposed geotextile with geotextile that has not been exposed to ultraviolet radiation.

3.2 ROLL WIDTHS

Whenever commercially available from any vendor, geotextile rolls shall be wide enough to cover the width of the road including any overhang without seams or laps. If the width of the road is greater than the width of the widest geotextile roll that is commercially available, then the CONTRACTOR shall sew or lap geotextile panels to form the desired width.

3.3 SEAMS AND OVERLAPS

If seams are used, all seams shall be sewn using thread meeting the requirements for plastic yarn specified in paragraph 2.1. The sheets of geotextile shall be sewn at the factory or other approved location. A minimum of 2 feet overlap in the direction perpendicular to the centerline of the road shall be used to join adjacent geotextile panels together. If laps are used in the direction parallel with the centerline of the road, then the overlap distance shall be 4 feet.

-- End of Section --

SECTION 31 37 16.13
RIPRAP

INDEX
SECTION 31 37 16.13 - RIPRAP

PART 1	GENERAL.....	2
1.1	SCOPE	2
1.2	REFERENCES	2
1.3	MEASUREMENT AND PAYMENT	2
1.4	SUBMITTALS	2
PART 2	PRODUCTS.....	2
PART 3	EXECUTION.....	2
3.1	CONSTRUCTION REQUIREMENTS	2
3.1.1	Depth and Distribution	2
3.1.2	Riprap Placement	2

SECTION 31 37 16.13

RIPRAP

PART 1 GENERAL

1.1 SCOPE

This work consists of replacing the existing graded stone riprap in accordance with these specifications and in conformity to lines, grades and thickness shown on the plans or as directed by the ENGINEER and any associated labor. The existing onsite riprap should be recycled for this work, which does not consist of furnishing graded stone riprap.

1.2 REFERENCES

Louisiana Department of Transportation and Development (LDOTD)

LDOTD 2006 (2006) Standard Specifications for Roads and Bridges Manual

1.3 MEASUREMENT AND PAYMENT

Measurement will be on a lump sum basis. All costs in connection therewith shall be included in the contract price for Bid Item: "Placement of Onsite Riprap." Price and payment shall include all costs of handling and placing to the lines and grades as shown on the plans.

1.4 SUBMITTALS

NOT USED

PART 2 PRODUCTS

NOT USED

PART 3 EXECUTION

3.1 CONSTRUCTION REQUIREMENTS

3.1.1 Depth and Distribution

Areas on which heavy deposited riprap is to be placed shall be graded to require sections. Heavy deposited riprap shall be placed and uniformly distributed over the areas. If placement in water currents is required, the CONTRACTOR shall make drift checks and place riprap in such a manner as to compensate for drift. The CONTRACTOR shall furnish necessary facilities and personnel for checking riprap depth and distribution.

A tolerance of +/- 6 inches from the finished grades shown on the plans will be allowed in the finished surface of the riprap.

3.1.2 Riprap Placement

Riprap shall be placed to its full course thickness in one operation and in such a manner as to avoid displacing the bedding material. Placing riprap in

Franklin Canal Pump Station

layers will not be permitted. Placing riprap by dumping it at the top of the slope and pulling it down the embankment slope will not be permitted.

When placing riprap adjacent to structures, care shall be exercised to avoid damage to the structure. The ENGINEER will inspect the placement of the riprap to insure that the finished sections are in conformance with the plans or as directed.

-- End of Section --

SECTION 31 62 13.20
PRECAST/PRESTRESSED CONCRETE PILES

INDEX

SECTION 31 62 13.20 - PRECAST/PRESTRESSED CONCRETE PILES

PART 1	GENERAL.....	3
1.1	SCOPE	3
1.2	REFERENCES	3
1.3	MEASUREMENT AND PAYMENT	5
1.3.1	Furnishing, Delivering and Driving Prestressed Concrete Piles ...	5
1.4	SUBMITTALS	6
1.5	PILE REQUIREMENTS	7
1.6	QUALITY ASSURANCE	7
1.6.1	Piles	7
1.6.2	Quality Control Procedures	7
1.6.3	Installation Procedures	7
1.6.4	Geotechnical Consultant Documentation If required	8
1.6.5	Concrete Mix Design	8
1.6.6	Silica Fume Manufacturer's Representative	8
1.7	DELIVERY, STORAGE, AND HANDLING	8
1.7.1	Damaged Piles	8
1.7.1.1	Repairable Cracks	8
1.7.1.2	Non-Repairable Cracks	9
1.7.1.3	Surface Defects and Fissures	9
1.7.2	Pile Sweep	9
1.8	ACCEPTANCE CRITERIA	9
PART 2	PRODUCTS.....	9
2.1	MATERIALS	9
2.1.1	Cementitious Materials	9
2.1.1.1	Cement	10
2.1.1.2	Fly Ash and Pozzolan	10
2.1.1.3	Ground Iron Blast-Furnace Slag	10
2.1.1.4	Silica-Fume	10
2.1.1.5	Supplemental Cementitious Materials (SCM) Content	10
2.1.2	Water	11
2.1.3	Aggregates	11
2.1.3.1	Alkali-Silica Reactivity (ASR)	11
2.1.4	Admixtures	12
2.1.5	Prestressing Steel	12
2.1.6	Reinforcing Steel	12
2.1.7	Ties and Spirals	12
2.1.8	Anchorage and End Fittings	12
2.1.9	Grout	12
2.1.10	Pile Driving Points	12
2.1.11	Pile Identification and Marking	12
2.2	CONCRETE MIX DESIGN	12
2.3	FABRICATION	13
2.3.1	Formwork	13
2.3.2	Pretensioning	13
2.3.3	Casting	13
2.3.3.1	Conveying	13
2.3.3.2	Placing and Casting	13
2.3.4	Curing of Piles	13
2.3.4.1	Moist Curing	13
2.3.4.2	Accelerated Curing	14
2.3.5	Detensioning	14
2.3.6	Pretensioning	14
2.4	PRODUCT QUALITY CONTROL	14
2.4.1	Aggregate Tests	14

Franklin Canal Pump Station

2.4.2	Slump and Strength Tests	15
2.4.3	Changes in Proportions	15
2.4.4	Compressive Strength Test Results	15
2.4.5	Chloride Ion Concentration	15
2.4.6	Chloride Ion Penetration	15
2.4.7	Certificates of Compliance	15
2.5	DYNAMIC TESTING	16
PART 3	EXECUTION.....	16
3.1	PILE DRIVING EQUIPMENT	16
3.1.1	Pile Hammers	16
3.1.1.1	Air/Steam	16
3.1.1.2	Hydraulic	16
3.1.1.3	Diesel	17
3.1.2	Driving Helmets and Pile Cushions	17
3.1.3	Cap Blocks	17
3.1.4	Pile Driving Leads	18
3.2	PRELIMINARY WORK	18
3.2.1	Wave Equation Analysis of Pile Drivability	18
3.2.2	Pile Length Markings	19
3.3	PILE DRIVING	19
3.3.1	Driving Piles	19
3.3.2	Protection of Piles	19
3.3.3	Tolerances in Driving	19
3.3.4	Rejected Piles	20
3.3.5	Heaved Piles	20
3.3.6	Pulled Piles	20
3.3.7	Jetting of Piles	20
3.3.8	Predrilling of Piles	20
3.3.9	Void Backfill	20
3.3.10	Splices	20
3.3.11	Build-Ups	20
3.3.12	Pile Cut-Off	21
3.4	TEMPLATES	21
3.5	DYNAMIC PILE TESTING	22
3.5.1	Access for Dynamic Testing	22
3.5.2	Driving System and Procedure	23
3.5.3	Dynamic Monitoring	23
3.5.4	Unexpected Driving Conditions	23

SECTION 31 62 13.20

PRECAST/PRESTRESSED CONCRETE PILES

PART 1 GENERAL

1.1 SCOPE

The work specified in this section consists of the furnishing all equipment, materials and labor for providing and installing precast/prestressed concrete piles for support of the pump station as indicated on the project plans.

1.2 REFERENCES

The publications listed below form a part of this specification to the extent referenced. The publications are referred to within the text by the basic designation only.

ACI INTERNATIONAL (ACI)

- | | |
|-----------|--|
| ACI 211.1 | (1991; R 2009) Standard Practice for Selecting Proportions for Normal, Heavyweight, and Mass Concrete |
| ACI 214R | (2002; Errata 2005) Evaluation of Strength Test Results of Concrete |
| ACI 318 | (2008; Errata 2008; Errata 2009; Errata 2009; Errata 2009; Errata 2009; Errata 2009) Building Code Requirements for Structural Concrete and Commentary |
| ACI SP-66 | (2004) ACI Detailing Manual |

AMERICAN WELDING SOCIETY (AWS)

- | | |
|----------------|---|
| AWS D1.4/D1.4M | (2005; Errata 2005) Structural Welding Code - Reinforcing Steel |
|----------------|---|

ASTM INTERNATIONAL (ASTM)

- | | |
|-------------------|--|
| ASTM A 27/A 27M | (2008) Standard Specification for Steel Castings, Carbon, for General Application |
| ASTM A 36/A 36M | (2008) Standard Specification for Carbon Structural Steel |
| ASTM A 416/A 416M | (2006) Standard Specification for Steel Strand, Uncoated Seven-Wire for Prestressed Concrete |
| ASTM A 496/A 496M | (2007) Standard Specification for Steel Wire, Deformed, for Concrete Reinforcement |

Franklin Canal Pump Station

ASTM A 572/A 572M	(2007) Standard Specification for High-Strength Low-Alloy Columbium-Vanadium Structural Steel
ASTM A 615/A 615M	(2009b) Standard Specification for Deformed and Plain Carbon-Steel Bars for Concrete Reinforcement
ASTM A 706/A 706M	(2009b) Standard Specification for Low-Alloy Steel Deformed and Plain Bars for Concrete Reinforcement
ASTM A 82/A 82M	(2007) Standard Specification for Steel Wire, Plain, for Concrete Reinforcement
ASTM A 996/A 996M	(2009b) Standard Specification for Rail-Steel and Axle-Steel Deformed Bars for Concrete Reinforcement
ASTM C 1202	(2009) Standard Test Method for Electrical Indication of Concrete's Ability to Resist Chloride Ion Penetration
ASTM C 1218/C 1218M	(1999; R 2008) Standard Specification for Water-Soluble Chloride in Mortar and Concrete
ASTM C 1240	(2005) Standard Specification for Silica Fume Used in Cementitious Mixtures
ASTM C 1260	(2007) Standard Test Method for Potential Alkali Reactivity of Aggregates (Mortar-Bar Method)
ASTM C 136	(2006) Standard Test Method for Sieve Analysis of Fine and Coarse Aggregates
ASTM C 143/C 143M	(2009) Standard Test Method for Slump of Hydraulic-Cement Concrete
ASTM C 150/C 150M	(2009) Standard Specification for Portland Cement
ASTM C 1567	(2008) Standard Test Method for Potential Alkali-Silica Reactivity of Combinations of Cementitious Materials and Aggregate (Accelerated Mortar-Bar Method)
ASTM C 172	(2008) Standard Practice for Sampling Freshly Mixed Concrete
ASTM C 260	(2006) Standard Specification for Air-Entraining Admixtures for Concrete
ASTM C 31/C 31M	(2009) Standard Practice for Making and Curing Concrete Test Specimens in the Field

Franklin Canal Pump Station

ASTM C 33/C 33M	(2008) Standard Specification for Concrete Aggregates
ASTM C 39/C 39M	(2009) Standard Test Method for Compressive Strength of Cylindrical Concrete Specimens
ASTM C 494/C 494M	(2008a) Standard Specification for Chemical Admixtures for Concrete
ASTM C 595/C 595M	(2009) Standard Specification for Blended Hydraulic Cements
ASTM C 618	(2008a) Standard Specification for Coal Fly Ash and Raw or Calcined Natural Pozzolan for Use in Concrete
ASTM C 666/C 666M	(2003; R 2008) Resistance of Concrete to Rapid Freezing and Thawing
ASTM C 989	(2009a) Standard Specification for Ground Granulated Blast-Furnace Slag for Use in Concrete and Mortars
ASTM D 1143/D 1143M	(2007e1) Piles Under Static Axial Compressive Load
ASTM D 3689	(1990, R 1995) Individual Piles Under Static Axial Tensile Load
ASTM D 3966	(1990; R 1995) Piles Under Lateral Loads
ASTM D 4945	(2012) High-Strain Dynamic Testing of Piles

PRECAST/PRESTRESSED CONCRETE INSTITUTE (PCI)

PCI JR-382	(1993) Recommended Practice for Design, Manufacture and Installation of Prestressed Concrete Piling
PCI MNL-116	(1999) Manual for Quality Control for Plants and Production of Structural Precast Concrete Products, 4th Edition
PCI STD-112	(1984) Standard Prestressed Concrete Piles Square, Octagonal and Cylinder

1.3 MEASUREMENT AND PAYMENT

1.3.1 Furnishing, Delivering and Driving Prestressed Concrete Piles

Furnishing, delivering and driving permanent prestressed concrete piles will be measured for payment by the linear foot of piles installed for Base Bid and Alternate 1.

Payment will be made for costs associated with furnishing, delivering and driving the required lengths of permanent prestressed concrete piles (including embedments) as indicated in the plans. No payment will be made

Franklin Canal Pump Station

for the driving head or lengths of piles exceeding required lengths. No payment will be made for piles damaged during delivery, storage, or handling to the extent that they are rendered unsuitable for the work, in the opinion of the ENGINEER. Payment will be made at the contract unit price for Bid Items: "18" Square Precast Prestressed Concrete (PPC) Piles."

1.4 SUBMITTALS

ENGINEER approval is required for submittals with an "E" designation; submittals not having an "E" designation are for information only.

SD-01 Preconstruction Submittals

Installation Procedures; E

Pile Driving Template Design; E

Wave Equation Analysis; E

Precasting manufacturer's quality control procedures; E

Repair Procedures and Products for Cracks, Surface Defects and Voids Left by Lifting Devices; E

SD-02 Shop Drawings

Piles; E

Include placements of prestressing strands, spiral wire ties, reinforcing bars, all embedments permanent and temporary.

SD-03 Product Data

Pile Driving Equipment; E

Submit descriptions of pile driving equipment, including hammers, power packs, driving helmets, cap blocks, pile cushions, leads, extractors, and preboring equipment at least 30 days prior to commencement of work.

SD-05 Design Data

Concrete mix design; E

Submit a concrete mix design before concrete is placed, for each type of concrete used for the piles.

SD-06 Test Reports

Aggregates; E

Silica Fume; E

Concrete Compressive Strength; E

Pile Driving Analysis; E.

Franklin Canal Pump Station

SD-07 Certificates

Aggregates; E

Admixtures; E

Silica fume manufacturer's representative; E

Prestressing steel; E

Reinforcing Steel; E

Cement; E

Fly ash and pozzolan; E

Ground Slag; E

1.5 PILE REQUIREMENTS

Provide precast prestressed concrete piles, PCI JR-382. Production of piles shall be in accordance with PCI MNL-116.

1.6 QUALITY ASSURANCE

1.6.1 Piles

Prepare in accordance with ACI SP-66. Indicate placement of reinforcement including tendons. Indicate location of special embedded or attached lifting devices, employment of pick-up points, support points other than pick-up points, and any other methods of pick-up. Provide certification of a Professional ENGINEER registered in the state of Louisiana, that layout and details of reinforcement and tendons conform with that shown on the structural design drawings.

1.6.2 Quality Control Procedures

Submit the precasting manufacturer's quality control procedures and inspection records established in accordance with PCI MNL-116.

1.6.3 Installation Procedures

Submit information on the type of equipment proposed to be used, proposed methods of operation, pile driving plan including proposed sequence of driving, and details of all pile driving equipment and accessories, and pressure measuring devices. Provide working drawings for templates (if used).

Provide details of pile driving equipment and a Wave Equation Analysis of pile drivability for selection of the hammer along with a statement of driving procedures. The Wave Equation Analysis is to be completed by the CONTRACTOR's Geotechnical Consultant for each pile location where different subsurface conditions exist and is to include the following information pertaining to the proposed pile driving equipment:

Complete Pile and Driving Equipment Data Form for each proposed pile hammer and pile type combination.

Franklin Canal Pump Station

Copies of computer input and output sheets and graphs showing soil resistance versus blow count as well as maximum tension and compression stresses versus blow count. Analysis shall be run at the estimated tip elevation as well as other required elevations to define maximum stress levels in the pile during driving.

1.6.4 Geotechnical Consultant Documentation If required

Not Required.

1.6.5 Concrete Mix Design

Certify, using a ENGINEER-approved independent commercial testing laboratory, that proportioning of mix is in accordance with ACI 211.1 or ACI 318 for specified strength and is based on aggregate data which has been determined by laboratory tests during last twelve months. Submit a complete list of materials including type; brand; source and amount of cement, fly ash, pozzolan, ground slag, and admixtures; and applicable reference specifications. Submit additional data regarding concrete aggregates if the source of aggregate changes. Submittal shall clearly indicate where each mix design will be used when more than one mix design is submitted.

1.6.6 Silica Fume Manufacturer's Representative

Provide statement that the manufacturer's representative will be present at plant to ensure proper mix, including high range water reducer (HRWR), and batching methods.

1.7 DELIVERY, STORAGE, AND HANDLING

Piles shall be stored, handled, and transported in accordance with PCI MNL-116 except as follows. Methods used for handling and storage of piles shall be such that the piles are not subjected to excessive bending stress, cracking, spalling, or other damage.

1.7.1 Damaged Piles

The CONTRACTOR shall inspect each pile for sweep and structural damage such as cracking and spalling before transporting them to the project site and immediately prior to placement in the driving leads. Any unusual cracks (cracks other than crazing, surface drying, shrinkage cracks and end cracks) shall be brought to the attention of the ENGINEER. Piles which are damaged during delivery, storage, or handling to the extent they are rendered unsuitable for the work, in the opinion of the ENGINEER, shall be rejected and removed from the project site, or may be repaired, if approved, at no cost to the OWNER.

1.7.1.1 Repairable Cracks

Piles with cracks equal to or greater than 0.006 inches but less than 0.06 inches shall be rejected or repaired. As an alternate to pile rejection, the CONTRACTOR may submit a proposal to repair deficient piles, which shall be restored prior to driving to provide its required design capacity, perform its intended function in the structure, and take into consideration long term durability in corrosive environment.

Franklin Canal Pump Station

1.7.1.2 Non-Repairable Cracks

Piles with cracks equal to or greater than 0.06 inches shall be rejected.

1.7.1.3 Surface Defects and Fissures

No rock packets or honeycombing will be allowed. Repair of such defects will not be permitted. Such defects will be cause to reject the pile.

Individual small surface defects such as air bubbles, voids, and fissures will be accepted without repair, if the voids or air bubbles are less than 1/2 inch in diameter and 3/8 inch in depth and if fissures do not penetrate more than 3/8 inch in depth.

1.7.2 Pile Sweep

Sweep shall be limited to 1/8 inch per 10 feet over the length of the pile. Piles having excessive sweep shall be rejected.

1.8 ACCEPTANCE CRITERIA

Safe Design Capacity for piles is 155 tons compression, 100 tons tension. Piles shall be driven to a minimum depth of -60.0 feet. The Safe Design Capacity is the Ultimate Capacity. A Safety Factor of 3, for piles installed without a test pile program, was applied to the working load to determine the required Safe Design Capacity.

The following formulas are presented only as a guide to aid in establishing the controlling penetration per blow, which, together with the minimum depth of penetration will serve to determine the required minimum depth of penetration of each individual pile:

$$R = \frac{2E}{S \text{ plus } 0.1} \quad \text{For double acting hammers}$$

$$R = \frac{2WH}{S \text{ plus } 0.1} \quad \text{For single acting hammers}$$

Where R is the approximate allowable pile load in kips; E equals the energy in foot-kips per blow based on an acceptable certified statement from the manufacturer of the hammer; W equals the weight of the hammer or ram in kips; H equals the height of fall of the hammer or ram in feet; and S equals the average inches of penetration per blow for the last three blows. An allowance shall be made for reduced penetration caused by shock absorption of the cushion or cap blocks.

PART 2 PRODUCTS

2.1 MATERIALS

2.1.1 Cementitious Materials

Cementitious materials shall be portland cement, blended cement or portland cement in combination with natural pozzolan or fly ash or ground granulated blast furnace slag and conforms to appropriate specifications listed below.

Franklin Canal Pump Station

2.1.1.1 Cement

ASTM C 150/C 150M, III with a maximum alkali content of 0.40 percent or ASTM C 595/C 595M, Type IP(MS) or IS(MS) blended cement except as modified herein. The blended cement shall consist of a mixture of ASTM C 150/C 150M cement with alkali content not exceeding 0.40 percent and one of the following materials: ASTM C 618 pozzolan or fly ash, or ASTM C 989 ground iron blast-furnace slag, or ASTM C 1240 silica fume. If no satisfactory test results are available made within the past six months to prove that the cement alkali content is less than 0.40 percent, then cement with a maximum of 0.60 percent alkali shall be used. Cement certificates shall include test results in accordance with ASTM C 150/C 150M, including equivalent alkalies indicated in the optional chemical requirements. Type III cement shall not be used in conjunction with silica fume.

2.1.1.2 Fly Ash and Pozzolan

ASTM C 618, Class N, or F except that the maximum total alkalies shall be 3.0 percent and the maximum allowable loss on ignition shall be 3 percent. If the aggregates are reactive, the maximum calcium oxide content shall be 13.0 percent. Class C shall not be used.

2.1.1.3 Ground Iron Blast-Furnace Slag

ASTM C 989, Grade 120.

2.1.1.4 Silica-Fume

ASTM C 1240, provide silica fume that is a by-product of silicon or ferrosilicon production. Provide percent by weight of the total cementitious materials as indicated in the table below.

2.1.1.5 Supplemental Cementitious Materials (SCM) Content

The concrete mix shall contain one of the SCMs listed below, or a linear combination thereof.

SUPPLEMENTARY CEMENTITIOUS MATERIALS CONTENT

SCM	Minimum Content	Maximum Content
Class N Pozzolan or Class F Fly Ash with SiO ₂ plus Al ₂ O ₃ plus Fe ₂ O ₃ greater than 70 percent	25 percent	35 percent
Class N Pozzolan or Class F Fly Ash with with SiO ₂ plus Al ₂ O ₃ plus Fe ₂ O ₃ greater than 80 percent	20 percent	35 percent
Class N Pozzolan or Class F Fly Ash with with SiO ₂ plus Al ₂ O ₃ plus Fe ₂ O ₃ greater than 90 percent	15 percent	35 percent

Franklin Canal Pump Station

GGBF Slag	30 percent	50 percent
Silica Fume	5 percent	10 percent

2.1.2 Water

Water shall be fresh, clean, and potable; free from injurious amounts of oils, acids, alkalis, salts, organic materials, or other substances deleterious to concrete or steel.

2.1.3 Aggregates

ASTM C 33/C 33M, except as modified herein. Provide aggregate free from any substance which may be deleteriously reactive with alkalis in cement in an amount sufficient to cause excessive expansion of concrete. Do not mix, store in same stockpile, or use fine aggregates from different sources of supply in same concrete mix or same structure without approval. The fineness modulus of fine aggregate shall be not less than 2.40 or greater than 3.0. For piles that will be exposed to freezing and thawing, fine and coarse aggregate subjected to five cycles of the sodium sulfate soundness test shall show a loss not greater than 10 percent. If the selected aggregates fail the soundness test, the CONTRACTOR may use the aggregate source, provided concrete specimens made with the aggregates to be used for the piles shall have a durability factor of not less than 80 based on 300 cycles of freezing and thawing when tested in accordance with ASTM C 666/C 666M. Prior to pile fabrication, submit certified test reports for the following tests specified in ASTM C 33/C 33M.

Grading

Amount of material finer than No. 200 sieve

Organic impurities

Soundness

Clay lumps and friable particles

Coal and lignite

Weight of slag

Abrasion of coarse aggregate

Fineness modulus

Reactive aggregates

Freezing and thawing

2.1.3.1 Alkali-Silica Reactivity (ASR)

Fine and coarse aggregates to be used in all concrete shall be evaluated and tested by the CONTRACTOR for alkali-aggregate activity.

The fine and coarse aggregates shall be evaluated separately, using ASTM C 1260. Test results of the individual aggregates shall have a measured expansion equal to or less than 0.08 percent at 16 days after casting. Should the test data indicate an expansion of greater than 0.08 percent, the aggregate(s) shall be rejected or additional testing, using ASTM C 1567, shall be performed as follows: utilize the CONTRACTOR's proposed low alkali Portland cement and SCM in combination with the proposed aggregate for the test portioning. The SCM quantity shall be determined that will meet all the requirements of these specifications and that will lower the ASTM C 1567 expansion to equal or less than 0.08 percent at 16 days after casting.

Franklin Canal Pump Station

If the above option does not lower the expansion to less than 0.08 percent at 16 days after casting, reject the aggregate(s) and submit new aggregate sources for retesting. Submit the results of testing to the ENGINEER for evaluation and acceptance.

2.1.4 Admixtures

Chemical admixtures shall conform to ASTM C 494/C 494M. Air-entraining admixture shall conform to ASTM C 260. Do not use admixtures containing chlorides.

2.1.5 Prestressing Steel

Use seven-wire stress-relieved or low-relaxation strand conforming to ASTM A 416/A 416M, Grade 270. Use prestressing steel free of grease, oil, wax, paint, soil, dirt, and loose rust. Do not use prestressing strands or wire having kinks, bends, or other defects.

2.1.6 Reinforcing Steel

ASTM A 615/A 615M, Grade 60; Weld reinforcing steel in accordance with AWS D1.4/D1.4M.

2.1.7 Ties and Spirals

Steel, ASTM A 82/A 82M for spirals and ASTM A 615/A 615M for ties.

2.1.8 Anchorages and End Fittings

ACI 318.

2.1.9 Grout

Provide cement grout for prestressed piles using materials conforming to requirements stipulated herein for concrete mixes. Use admixtures, if required, known to have no injurious effects on steel or concrete. Do not use calcium chloride.

2.1.10 Pile Driving Points

Pile driving points shall be of steel conforming to the requirements of ASTM A 27/A 27M or ASTM A 36/A 36.

2.1.11 Pile Identification and Marking

Each pile shall be clearly and indelibly marked at the top of pile with a unique identity number, length, and the date cast.

2.2 CONCRETE MIX DESIGN

ACI 211.1 or ACI 318, Chapter 4. Concrete shall have a minimum compressive strength of 6000 psi at 28 days and a maximum size aggregate of $\frac{3}{4}$ inches. Concrete shall be air entrained with a minimum of 4.5 percent and a maximum of 7.5 percent. Mix shall contain fly ash, ground iron blast furnace slag or silica fume to meet the requirements specified herein to mitigate Alkali-Silica Reactivity (ASR). For marine exposure, ensure a dense concrete free

Franklin Canal Pump Station

of shrinkage cracks, with a minimum degree of permeability. The maximum water cement ratio shall be 0.40.

2.3 FABRICATION

2.3.1 Formwork

Formwork and dimensional tolerances shall be in accordance with PCI MNL-116, and as specified herein. Provide forms of metal, braced and stiffened against deformation, accurately constructed, watertight, and supported on unyielding casting beds. Forms shall permit movement of pile without damage during release of prestressing force. Form precast dowel holes with galvanized flexible metal conduit. Inside forms or void tubes not to be grouted may be treated cardboard, plywood, or other material.

2.3.2 Pretensioning

Pretensioning shall be performed in accordance with PCI MNL-116, and as specified herein. Use gage calibrated within last 6 months by a laboratory approved by ENGINEER. Provide means for measuring elongation of steel to nearest 1/8 inch. Give tensioning steel a uniform prestress prior to being brought to design prestress. Induce same initial prestress in each unit when several units of prestressing steel in a pile are stretched simultaneously.

2.3.3 Casting

2.3.3.1 Conveying

Convey concrete to formwork in accordance with PCI MNL-116, and as specified herein. Clean conveying equipment thoroughly before each run. During placing, make any free vertical drop of the concrete less than 3 feet. Remove concrete which has segregated in conveying or placing.

2.3.3.2 Placing and Casting

Perform concrete casting within 3 days after pretensioning steel; however, do not deposit concrete in forms until placement of reinforcement and anchorages has been inspected and approved by pile manufacturer's quality control representative. Produce each pile of dense concrete straight with smooth surfaces with reinforcement retained in its proper position during fabrication. Use vibrator with heads smaller than the minimum distance between steel for pretensioning. Make surface of pile ends perpendicular to axis of pile. Chamfer, a minimum of 3/4 inch, ends of piles and corners of square piles.

2.3.4 Curing of Piles

Cure piles using moist or accelerated curing. Curing of piles shall be in accordance with the PCI MNL-116 except as follows. The maximum rate of heat gain shall not exceed 40 degrees Fahrenheit per hour and the maximum concrete temperature shall not exceed 165 degrees Fahrenheit during the curing cycle. Curing shall be continued until the concrete has attained a compressive strength of at least 3500 psi as determined by the concrete test cylinders.

2.3.4.1 Moist Curing

Franklin Canal Pump Station

Moist cure using moist burlap coverings, plastic sheeting, or membrane curing compound until minimum strength to detension is achieved.

2.3.4.2 Accelerated Curing

After placement of concrete, moist cure for a period of 4 hours. Follow by accelerated curing until concrete has reached specified release strength. Enclose casting bed for accelerated curing with a suitable enclosure. During application of steam or heat, increase the air temperature at a rate not to exceed 40 degrees F per hour. Cure at a maximum temperature of 150 degrees F until concrete has reached specified release strength. Reduce temperature at a rate not to exceed 20 degrees F per hour until a temperature of 20 degrees F above ambient air temperature is reached. After accelerated curing, moist cure using either water or membrane curing until a total accelerated and moist curing time of 72 hours is achieved.

2.3.5 Detensioning

Detensioning shall be performed in accordance with PCI MNL-116, and as specified herein. Gradually release tension in strands from anchorage. Detension after approval by pile manufacturer's quality control representative. Perform transfer of prestressing force when concrete has reached a minimum compressive strength of 3,500 psi.

2.3.6 Pretensioning

Anchorage for tensioning the prestressing steel shall be an approved type. The tension to which the steel is to be pretensioned shall be measured by the elongation of the steel and also by the jack pressure reading on a gauge or by the use of an accurately calibrated dynamometer. The gauge or dynamometer shall have been calibrated by a calibration laboratory approved by the ENGINEER within 12 months of commencing work and every 6 months thereafter during the term of the contract. Means shall be provided for measuring the elongation of the steel to the nearest 1/4 inch. The applied load determined from elongation measurements shall be computed using load-elongation curves for the steel used. When the difference between the results of measurement and gauge reading is more than 5 percent, the cause of the discrepancy shall be corrected. The tensioning steel shall be given a uniform prestress prior to being brought to design prestress. The same initial prestress shall be induced in each unit when several units of prestressing steel in a pile are stretched simultaneously.

2.4 PRODUCT QUALITY CONTROL

Where piling is manufactured in a plant with an established quality control program as attested to by a current certification in the PCI "Certification Program for Quality Control" perform product quality control in accordance with PCI MNL-116. Where piling is manufactured by specialists or in plants not currently enrolled in the PCI "Certification Program for Quality Control," set-up a product quality control system in accordance with PCI MNL-116 and perform concrete and aggregate quality control testing using an independent commercial testing laboratory approved by the ENGINEER in accordance with the following.

2.4.1 Aggregate Tests

Franklin Canal Pump Station

Take samples of fine and coarse aggregate at concrete batch plant and test. Perform mechanical analysis (one test for each aggregate size) in accordance with ASTM C 136. Tabulate results of tests in accordance with ASTM C 33/C 33M.

2.4.2 Slump and Strength Tests

Sample concrete in accordance with ASTM C 172 at time concrete is deposited for each production line. Perform slump tests in accordance with ASTM C 143/C 143M. Mold cylinders in accordance with ASTM C 31/C 31M. Mold at least six cylinders per day or one for every 20 cubic yards of concrete placed, whichever is greater. Cure cylinders in same manner as piles and for accelerated curing, place at coolest point in casting bed. Perform strength tests in accordance with ASTM C 39/C 39M. Test two cylinders of each set at 7 days or 14 days, or at a time for establishing transfer of prestressing force (release strength) and removal of pile from forms. Test remaining cylinders of each set 28 days after molding.

2.4.3 Changes in Proportions

If, after evaluation of strength test results, compressive strength is less than specified compressive strength, make adjustments in proportions and water content and changes in temperature, moisture, and curing procedures as necessary to secure specified strength. Submit changes in mix design to ENGINEER in writing.

2.4.4 Compressive Strength Test Results

Evaluate compressive strength test results at 28 days in accordance with ACI 214R using a coefficient of variation of 10 percent. Evaluate strength of concrete by averaging test results of each set of standard cylinders tested at 28 days. Not more than 10 percent of individual cylinders tested shall have a compressive strength less than specified design strength.

2.4.5 Chloride Ion Concentration

Sampling and determination of water soluble chloride ion content in accordance with ASTM C 1218/C 1218M. Maximum water soluble chloride ion concentrations in hardened concrete at ages from 28 to 42 days contributed from the ingredients including water, aggregates, cementitious materials, and admixtures shall not exceed 0.15 percent by weight of cement.

2.4.6 Chloride Ion Penetration

To ensure the durability of concrete in marine environment, concrete shall be proportioned to have the chloride ion penetration test in accordance with ASTM C 1202, and be below 3000 coulombs for concrete specimens tested at 56 days.

2.4.7 Certificates of Compliance

The CONTRACTOR shall certify that admixtures, aggregates, cement, and pozzolan used conform with the requirements of the specifications. Manufacturer's literature indicating conformance may be submitted for admixtures.

2.5 DYNAMIC TESTING

On 1/3 of piles inclusive of first pile driven, dynamic monitoring shall be performed using a Pile Driving Analyzer. All equipment necessary for the dynamic monitoring such as sensors, cables, etc., will be furnished by the Dynamic Testing Consultant provided by the CONTRACTOR. The equipment shall conform to the requirements of ASTM D 4945. An ENGINEER with a minimum of five (5) years of experience shall operate the Pile Driving Analyzer in the field.

PART 3 EXECUTION

3.1 PILE DRIVING EQUIPMENT

3.1.1 Pile Hammers

All equipment is subject to satisfactory field performance. Use variable energy hammer to drive concrete piles. Hammers will be rated based on the theoretical energy of the ram at impact. Equipment approval will be based on the wave equation analysis performed by the CONTRACTOR's geotechnical consultant and the ENGINEER's review of that submittal. Stresses predicted by wave equation analysis shall not exceed 0.85 times the concrete compressive strength minus the effective prestress in compression and the effective prestress in tension. Refer to Section 3.2.1 for additional discussion regarding wave equation analysis. Additional equipment approval requirements are needed if diesel hammers are used as stated in Section 3.5.

3.1.1.1 Air/Steam

Variable energy air/steam hammers shall be capable of providing at least two ram stroke lengths. The short ram stroke length shall be approximately half of the full stroke for hammers with strokes up to 4 feet and no more than 2 feet for hammers with maximum stroke lengths over 4 feet. Operate and maintain air/steam hammers within the manufacturer's specified ranges. Use a plant and equipment for steam and air hammers with sufficient capacity to maintain, under working conditions, the hammer, volume and pressure specified by the manufacturer. Equip the plant and equipment with accurate pressure gauges which are easily accessible to ENGINEER. ENGINEER will not accept final bearing on piles the CONTRACTOR drives with air/steam hammers unless the CONTRACTOR operates the hammers within 10% of the manufacturer's rated speed in blows per minute, unless otherwise authorized by ENGINEER.

3.1.1.2 Hydraulic

Variable energy hydraulic hammers shall have at least three hydraulic control settings that provide for predictable stroke control. The shortest stroke shall be a maximum of 2 feet for the driving of concrete piles. The remaining strokes shall be full stroke and approximately halfway between minimum and maximum stroke. The hammer energy shall be determined according to the manufacturer's recommendations. When pressure measuring equipment is required to determine hammer energy, the pressure gauges shall be calibrated before use. Most hydraulic hammers have a means of recording stroke and/or applied energy to the pile. The CONTRACTOR shall utilize the equipment and provide results to ENGINEER on a daily basis. Project QA/QC shall have the ability to obtain such documentation at any time.

3.1.1.3 Diesel

If a diesel hammer is planned, then dynamic pile testing is required. Refer to Section 3.5. Variable energy diesel hammers shall have at least three fuel settings that will produce reduced strokes. Operate and maintain diesel hammers within the manufacturer's specified ranges. Determine the rated energy of diesel hammers using measured ram stroke length multiplied by the weight of the ram for open end hammers and by methods recommended by the manufacturer for closed end hammers. Determine the actual hammer energy in the field so that it is consistent with hammer energy used for each bearing capacity determination. Equip open-end (single acting) diesel hammers with a scale (jump stick) extending above the ram cylinder to permit ENGINEER to visually determine the hammer stroke at all times during pile driving operations. Provide ENGINEER with a chart from the hammer manufacturer equating stroke and blows per minute for the open-end diesel hammer to be used. Also provide and maintain in working order for ENGINEER's use an approved device to automatically determine and display ram stroke for open-end diesel hammers. Equip closed-end (double acting) diesel hammers with a bounce chamber pressure gauge, in good working order, mounted near ground level so ENGINEER can easily read. Also, provide ENGINEER with a chart, calibrated to actual hammer performance, within 30 days prior to initial use, equating bounce chamber pressure to either equivalent energy or stroke for the closed-end diesel hammer to be used.

3.1.2 Driving Helmets and Pile Cushions

Use a steel driving helmet or cap including a pile cushion between top of pile and driving helmet or cap to prevent impact damage to pile. Use a driving helmet or cap and pile cushion combination capable of protecting pile head, minimizing energy absorption and dissipation, and transmitting hammer energy uniformly over top of pile. Provide driving helmet or cap that fits sufficiently loose around top of pile so that pile may be free to rotate without binding within driving helmet. Use pile cushion of solid wood or of laminated construction using plywood, softwood or hardwood boards with grain parallel to end of pile. Provide pile cushion with thickness of 3 inches minimum and the thickness shall be increased so as to be suitable for the size and length of pile, character of the sub-surface material to be encountered, hammer characteristics, and the required driving resistance. Use pile cushion sized so that it will fully fill the lateral dimensions of the pile helmet. Replace pile cushion at the start of driving of each pile and when it becomes highly compressed, charred or burned, or has become spongy or deteriorated in any manner. Show details of driving helmets, capblocks, and pile cushion.

3.1.3 Cap Blocks

The cap block (hammer cushion) used between the driving cap and the hammer ram may be of solid hardwood block with grain parallel to the pile axis and enclosed in a close-fitting steel housing or may consist of aluminum and approved industrial type plastic laminate disks stacked alternately in a steel housing. Steel plates shall be used at the top and the bottom of the cap block. The cap block shall be replaced if it has been damaged, highly compressed, charred, or burned or has become spongy or deteriorated in any manner. If a wood cap block is used, it shall not be replaced during the final driving of any pile. Under no circumstances will the use of small wood

blocks, wood chips, rope, or other material permitting excessive loss of hammer energy be permitted.

3.1.4 Pile Driving Leads

Leads shall align the pile and hammer concentrically, and maintain the pile in proper position and alignment throughout driving. Hammers shall be supported and guided with fixed extended leads or fixed underhung leads. The leads shall be of sufficient length to fully accommodate the combined length of the pile and hammer. Two intermediate pile supports shall be provided in the leads to reduce the unbraced length of the pile during driving and pulling.

3.2 PRELIMINARY WORK

3.2.1 Wave Equation Analysis of Pile Drivability

Prior to driving any pile, the CONTRACTOR shall submit a pile Wave Equation Analysis, performed by his Geotechnical Consultant, for each size pile and distinct subsurface profile condition. These analyses shall take into account the proposed hammer assembly, pile cap block and cushion characteristics, the pile properties and estimated lengths and the soil properties anticipated to be encountered throughout the installed pile length based on static capacity analysis with consideration of driving gain/loss factors. Only one specific model of pile hammer may be used for each pile type and capacity.

The Wave Equation Analysis shall demonstrate that the piles will not be damaged during driving, shall indicate that the driving stresses will be maintained within the limits below and indicate the blow count necessary to achieve the required ultimate static pile capacities.

Allowable Driving Stresses

Steel Piles

Compression - $0.9 f_y$

Tension - $0.9 f_y$

Where f_y is yield strength of steel

Concrete

Compression - $0.85f'_c$ minus UPL

Tension - (3 times (the square root of f'_c)) plus UPL

f'_c is compressive strength of concrete

UPL = Unit Prestress after Losses

(Obtain values from pile manufacturer)

All pile driving equipment furnished by the CONTRACTOR shall be subject to the approval of the ENGINEER. Complete the attached pile and driving equipment data form, including hammer information, in full as part of the submittal of the results of the Wave Equation Analyses.

Franklin Canal Pump Station

The cost of performing the Wave Equation Analyses shall be paid for by the CONTRACTOR and included in the base bid.

3.2.2 Pile Length Markings

The CONTRACTOR shall mark each pile prior to driving with horizontal lines at one foot intervals, and the number of feet from pile tip at 5 foot intervals.

3.3 PILE DRIVING

3.3.1 Driving Piles

Notify ENGINEER 10 days prior to driving of piles. Foundation excavation shall be stopped at 1 foot above foundation grade before piles are driven. When pile driving is completed, excavation shall be completed to lines and grade shown. Piles may be driven when the specified 28-day concrete strength has been achieved but not less than 7 days after casting. Drive piles to indicate tip elevation. During initial driving and until pile tip has penetrated beyond layers of very soft soil, use a reduced driving energy of the hammer as required to prevent pile damage. Refusal criteria shall be established by the ENGINEER. If a pile fails to reach indicated tip elevation, or if a pile reaches tip elevation without reaching required driving resistance, notify ENGINEER and perform corrective measures as directed. Provide hearing protection when noise levels exceed 140 dB. Piles or pile sections shall not be handled or moved in any manner that would result in cracking or permanent damage to the concrete or to the grout surrounding the prestressing cables. Piles may be driven without pile guides or leads providing a hammer guide frame is used to keep the pile and hammer in alignment.

3.3.2 Protection of Piles

Take care to avoid damage to piles during handling, placing pile in leads, and during pile driving operations. Support piles laterally during driving, but allow rotation in leads. Where pile or projecting reinforcement orientation is essential, take precautionary measures to maintain the orientation during driving. Take special care in supporting battered piles to prevent excessive bending stresses in pile. Square top of pile to longitudinal axis of pile. Maintain axial alignment of pile hammer with that of the pile. If the CONTRACTOR elects to use a pile head with projecting strands or mild steel reinforcement, prevent direct impact forces from being transmitted through the reinforcement, by using a special driving head.

3.3.3 Tolerances in Driving

Drive piles with a variation of not more than +0", -1" from vertical for plumb piles. A final lateral deviation from the correct location at the pile head elevation of not more than 1/2 inches shall be permitted. Maintain and check axial alignment of pile and leads at all times. If subsurface conditions cause pile drifting beyond allowable axial alignment tolerance, notify ENGINEER and perform corrective measures as directed. Place butts within 1/2 inches of location indicated and within tolerance of +0", -1" vertically from required elevation. Manipulation of piles within specified tolerances will not be permitted. If clear distance cannot be maintained,

Franklin Canal Pump Station

then notify ENGINEER. Check each pile for heave. Redrive heaved piles to required point elevation.

3.3.4 Rejected Piles

Piles damaged or impaired for use during handling or driving, mislocated, or driven out of alignment beyond the maximum tolerance shall be withdrawn and replaced by new piles or shall be cut-off and abandoned and new piles driven as directed. Excess cut-off from piles and unacceptable piles shall be removed from the work site. All work in connection with withdrawing and removing rejected piles from the site shall be done at no additional cost to the OWNER.

3.3.5 Heaved Piles

When driving piles in clusters or under conditions of relatively close spacing, observations shall be made to detect heave of adjacent piles. Heaved piles shall be restruck sufficiently to relieve soil setup and driven to the original penetration criteria.

3.3.6 Pulled Piles

Piles damaged or impaired for use during driving shall be pulled and replaced with new piles, or shall be cut off and abandoned and new piles driven as directed. The ENGINEER may require that any pile be pulled for inspection. Piles pulled at the direction of the ENGINEER and found to be in suitable condition shall be redriven at a directed location.

3.3.7 Jetting of Piles

Water jets will not be permitted.

3.3.8 Predrilling of Piles

Predrilling to remove soil or other material representing the bulk of the volume of the pile to be driven will not be permitted.

3.3.9 Void Backfill

Voids occurring around piles as a result of pile driving or due to any other cause and abandoned holes for piles that have been pulled shall be filled to within 3 feet of the adjacent ground surface with a tremie-placed slurry (from bottom to top of hole). The slurry shall consist of one part portland cement, two parts bentonite, and six parts sand mixed with enough water to produce a slurry viscous enough to thoroughly fill the voids. The upper 3 feet of the hole shall be filled with earth and compacted to the same density as the surrounding soil.

3.3.10 Splices

Splicing of piles is not permitted.

3.3.11 Build-Ups

Where required, pile section may be extended to cut-off elevation by means of a cast-in-place reinforced concrete build-up. Make build-up in accordance

with PCI STD-112. Construct build-ups made after completion of driving in accordance with detail, "Build-Up Without Driving." Make build-ups to be driven in accordance with detail "Build-Up With Driving." Have details of means for protecting joints by a suitable mortar or epoxy approved by ENGINEER. Where build-ups are exposed to water, protect cast-in-place section from water during curing period. Concrete in build-up shall have a minimum compressive strength of 5000 psi. Build-ups will not be permitted without approval of the ENGINEER. Payment for such withdrawal and replacement will be made as an adjustment to the contract price.

3.3.12 Pile Cut-Off

Cut-off piles with a smooth level cut using pneumatic tools, sawing, or other suitable methods approved by ENGINEER. Use of explosives for cutting is not permitted. Cut-off sections of piles shall be removed from the site upon completion of the work.

3.4 TEMPLATES

Provide a fixed template, adequate to maintain the pile in proper position and alignment during driving with swinging leads or with semi-fixed leads. For piles on land, locate the template with 5 feet of cutoff or within 5 feet of ground line, whichever is less. For piles in water, locate the template within 5 feet of cutoff or within 5 feet of the waterline, whichever is less. Do not use floating templates (attached to a barge.) Template anchor piles shall not reduce the soil support capacity if the permanent production pipe piles on sheet piles as determined by the ENGINEER.

Where practical, place the template so that the pile can be driven to cut-off elevation before removing the template. When proposing to use a free hammer, provide a rigid double template that will independently support the pile. Provide free hammers with approved guide extensions that hold the hammer in alignment with the pile to ensure that the hammer blow is applied axially to the pile at all times.

When driving piles with a follower using floating equipment, provide a double template or other approved equipment to maintain alignment of the hammer, follower, and pile. Use a double template consisting of a pile template within 5 feet of cut-off elevation and a second upper support above the water surface for the leads. Where practical, place the template so that the pile can be driven to cut-off elevation before removing the template. Ensure that the individual pile positions of the second upper template are adjustable in size to serve as a guide for both the pile and follower. Ensure that templates do not restrict the vertical movement of the pile.

CONTRACTOR shall submit working drawings for the piling templates, supplemented by calculations as necessary that shall contain at a minimum, the following items:

Details and calculations demonstrating how to provide and maintain the specified axial alignment of the pile to within 1/8 inch per foot of pile length.

Details and calculations demonstrating adequate support and stability for the pile and template with full operating weight and dynamic loading of the proposed hammer at the top of the pile.

Provisions to provide stability and maintain alignment during placement of piles in wind, wave and current conditions.

Provisions to adequately accommodate the forces associated with or prevent the pile from running under its own weight and the weight of the hammer.

Template support piles shall be located a minimum of 5 pile diameters (larger of template pile and permanent pile diameter) net clearance from permanent pile if template pile will be pulled for removal. For template piles placed closer than clearance above template pile shall be cut-off 2' below mud line of otherwise it shall be augered clear and pulled in conjunction with grouting of underground void from pile tip to mud line. Grout shall be concrete (La. DOTD Class R), cement (max. 5 gallons of water per 94 pound sack of cement), bentonite cement (less than or equal to 8% bentonite by dry weight of cement and a maximum of 10 gallons of water per 94 pound sack of cement), or bentonite pellets.

3.5 DYNAMIC PILE TESTING

Dynamic testing involves attaching at least two strain transducers and two accelerometers to the pile near the pile head during initial driving or at a convenient location during restrike testing. A cable connects the gauges near the pile head with the Pile Driving Analyzer (PDA) located a safe distance from the pile but not more than 330 feet from the pile.

The CONTRACTOR shall secure the services of a Dynamic Testing Consultant. Dynamic testing (PDA) shall be performed on piles throughout production driving. At a minimum, the first production pile installed will be subjected to PDA to verify pile integrity is adequate during installation.

3.5.1 Access for Dynamic Testing

Prior to lifting the pile to be dynamically tested, the CONTRACTOR shall provide a minimum of three feet of clear access to 180 degree opposite faces of the pile for pile preparation. The Dynamic Testing Consultant shall identify the appropriate level on the pile to attach the PDA gauges. The Dynamic Testing Consultant personnel shall then drill and prepare holes in the pile for attachment of sensors. The Dynamic Testing Consultant personnel shall attach the gauges to the pile before the pile is driven. The CONTRACTOR shall provide a qualified member of the driving crew to assist the Dynamic Testing Consultant with gauge attachment, as directed. Driving shall then continue using routine pile installation procedures. The Dynamic Testing Consultant shall perform the internal calibration check and take the dynamic measurements for the impacts together with routine observation of penetration resistance. The force and velocity signals from the pile driving analyzer shall be calibrated before the dynamic testing begins. Driving of the pile shall then continue using the installation procedures outlined in these specifications.

When the level of the sensors is within one (1) foot from any obstruction endangering the survival of the sensors or cables, if the obstruction cannot be removed, driving shall be halted to remove the sensors from the pile. If the pile is equipped with PDA gauges not intended for underwater use, driving should be halted when the level of the gauge approaches one (1) foot from the water surface.

3.5.2 Driving System and Procedure

During dynamic testing, the pile driving shall be performed in accordance with the project specifications and the driving criteria established for the particular pile being tested. The same driving system used during production pile driving shall be used during the dynamic monitoring. Similarly, any procedures or methods used by the CONTRACTOR during production pile installation shall be performed during the dynamic monitoring.

The ENGINEER may request additional production piles to be dynamically tested if the hammer and/or driving system is replaced or modified, the pile type or installation procedures are modified, unusual blow counts or penetration criteria are observed or the Dynamic Testing Consultant or the ENGINEER determines that the driving behavior differs from normal installation.

3.5.3 Dynamic Monitoring

Dynamic monitoring shall be performed in accordance with ASTM D 4945 and as directed by the Dynamic Testing Consultant or the ENGINEER. Dynamic testing data shall be recorded on every blow throughout the monitored length for all piles monitored.

Installation is typical of normal pile installation except the Dynamic Testing Consultant or the ENGINEER may stop driving to request changes in hammer fuel setting, or to check the PDA gauges and equipment. If requested, the CONTRACTOR shall provide Dynamic Testing Consultant access to the head of the pile to check the gauge and cable attachments, change gauges, or perform similar work. The CONTRACTOR shall provide a qualified member of the pile driving crew to assist Dynamic Testing Consultant with such work, as directed.

Should the PDA monitoring show unacceptable stresses during driving, combinations of hammer cushions and thicknesses and hammer fuel/stroke settings may be investigated during the monitoring. The CONTRACTOR shall change cushions or change hammer fuel/stroke settings when requested by the Dynamic Testing Consultant or the ENGINEER.

3.5.4 Unexpected Driving Conditions

In cases of unexpected or questionable driving conditions during non-monitored production pile driving, the ENGINEER may request dynamic pile monitoring to evaluate pile integrity and/or pile capacity. Questionable driving conditions or circumstances where non-planned PDA monitoring may be performed shall be based on but not limited to the following:

- a. A sudden change in blow count. This includes changes in blow count increasing or decreasing.
- b. Pile refusal prior to achieving the anticipated pile tip elevation.
- c. A shift or angle change in the pile during driving.
- d. A sudden change in the performance of the pile driving hammer. This includes, but is not limited to, the pile driving hammer stroke, blow rate and energy.
- e. A circumstance where any portion of the driving criteria is violated.
- f. A question regarding pile integrity. This includes integrity concerns arising from driving, handling and storage of the pile prior to, during and after pile installation.

- g. Circumstances where adjacent construction activities may influence the long term performance of the pile.

The Dynamic Testing Consultant must be prepared to monitor the pile and the PDA monitored driving should be commenced within three (3) hours from the initial installation to avoid excessive delays in construction. The Dynamic Testing Consultant shall provide preliminary recommendations while the pile is being monitored. Final recommendations, which shall include justification for monitoring the pile, should be submitted within 24 hours after the completion of the monitoring.

-- End of Section --

SECTION 31 62 14
STEEL PIPE PILES

INDEX
SECTION 31 62 14 - STEEL PIPE PILES

PART 1	GENERAL.....	2
1.1	SCOPE	2
1.2	REFERENCES	2
1.3	MEASUREMENT AND PAYMENT	2
1.4	SUBMITTALS	3
1.5	HANDLING	4
1.5.1	Delivery and Storage	4
1.5.2	Handling Plan	5
1.6	PILE SURVEY PLAN	5
PART 2	PRODUCTS.....	5
2.1	MATERIALS	5
2.1.1	Pipe Piles	5
2.1.2	Pile Identification and Marking	6
2.2	FABRICATION	6
2.2.1	Tolerances	6
2.2.2	Welded Splices	6
2.2.3	Painting.....	7
PART 3	EXECUTION.....	7
3.1	DRIVING HAMMER	7
3.1.1	Air Hammers	8
3.1.2	Hydraulic Hammers	8
3.2	DRIVING HELMET	9
3.3	HAMMER CUSHION	9
3.4	TEMPLATES	9
3.5	PILE INSTALLATION/DRIVING PLAN	10
3.5.1	Pile Placement and Tolerances	10
3.5.2	Pile Installation Plan	11
3.5.3	Driving Schedule	11
3.5.4	Pile Survey Plan	11
3.5.5	Pile Repair Plan	11
3.5.6	Driving Records	11
3.5.7	Penetration Criteria	12
3.6	JETTING	12
3.7	HEAVED PILES	12
3.8	PLAN FOR FIELD SPLICES	12
3.9	WAVE EQUATION ANALYSIS	13
3.10	TOUCH-UP PAINTING	14

SECTION 31 62 14

STEEL PIPE PILES

PART 1 GENERAL

1.1 SCOPE

This work consists of providing and installing steel pipe piles. This work shall include providing all labor, materials, appliances, tools, equipment, services, supervision, and incidentals to install steel piles as required by the specifications and as shown on the plans.

1.2 REFERENCES

ASTM INTERNATIONAL (ASTM)

ASTM A 36/A 36M	(2008) Standard Specification for Carbon Structural Steel
ASTM A 500/A 500M	(2009) Standard Specification for Cold-Formed Welded and Seamless Carbon Steel Structural Tubing in Rounds and Shapes
ASTM A 572/A 572M	(2007) Standard Specification for High-Strength Low-Alloy Columbium-Vanadium Structural Steel
ASTM A 6/A 6M	(2008) Standard Specification for General Requirements for Rolled Structural Steel Bars, Plates, Shapes, and Sheet Piling
ASTM A 633/A 633M	(2001; R 2006) Standard Specification for Normalized High-Strength Low-Alloy Structural Steel Plates

AMERICAN PETROLEUM INSTITUTE (API)

API Spec 2H	(2006) Specification for Carbon Manganese Steel Plate for Offshore Structures - Ninth Edition
API Spec 5L	(2007; Errata 2009) Specification for Line Pipe

AMERICAN WELDING SOCIETY (AWS)

AWS D1.1/D1.1M	(2006; Errata 2006) Structural Welding Code - Steel
----------------	---

1.3 MEASUREMENT AND PAYMENT

Piling will be measured by the linear foot of pile below pile cut-off elevation for Base Bid and Alternate 1. For batter piles, cut-off elevation shall be the highest point on the pile.

Franklin Canal Pump Station

Splices required to obtain order lengths will not be measured for payment.

Pilot holes and jetting will not be measured for payment.

Payment for piling will be made at the contract unit price per linear foot under Bid Items: "12" Diameter Steel Pipe Piles."

1.4 SUBMITTALS

ENGINEER approval is required for submittals with an "E" designation. Submittals with no designation are considered for information only. Submit the following:

SD-01 Preconstruction Submittals

Steel Certification

Handling Plan; E

Submit handling plans for piles and calculation of pile stresses resulting from handling operations at least 30 days prior to delivery of piles to the job site.

Pile Installation Plan; E

Driving Schedule; E

Pile Survey Plan

Pile Repair Plan; E

Submit a plan to repair the piles should they be damaged during installation.

Welders Certifications

Procedure Qualification Records (PQR)

Welding Procedures (Certified welding procedure specifications [WPS])

Welding Inspector Certifications

Welder Performance Qualifications Certification (WPQ)

SD-02 Shop Drawings

Shop Drawings, including pile fabrication drawings with cut off allowances noted, piece identification marks and corresponding erection plan locations; E

Plan for Field Splices; E

SD-03 Product Data

Pile Hammer; E

Franklin Canal Pump Station

SD-05 Design Data

Wave Equation Analysis; E

The CONTRACTOR shall submit wave equation analysis to size the pile hammer system in accordance with paragraph WAVE EQUATION ANALYSIS.

Pile Installation/Driving Plan; E

Working drawings for piling templates and handling shall be supplemented by calculations, as necessary, and shall contain at a minimum, the following items:

Details and calculations demonstrating how to provide and maintain the specified axial alignment of the pile to within 1/8 inch per foot of pile length.

Details and calculations demonstrating adequate support and stability for the pile and template with the full operating weight and dynamic loading of the proposed hammer at the top of the pile.

Provisions to provide stability and maintain alignment during placement of the piles in wind, wave and current conditions.

Provisions to adequately accommodate the forces associated with or prevent the pile from running under its own weight and the weight of the hammer.

Provisions for providing adequate work space for pile welding, cutting and inspection.

Provisions for providing alignment and support to prevent movement during field welding and to ensure that welding tolerances are met.

Details and equipment used for handling of pile including the use of temporary supporting brackets.

Calculation of pile stresses resulting from handling operations.

SD-06 Test Reports

Weld Inspection Reports

1.5 HANDLING

1.5.1 Delivery and Storage

Piles shall be stacked during storage and delivery so that each pile is maintained in a straight position and is supported every 10 feet or less along its length (ends inclusive) to prevent exceeding the maximum camber or sweep. Piles shall not be stacked more than 15 feet high. All piles, pile splices and cutoffs, pile connectors and pulled piles that remain at the completion of the project shall become the property of the CONTRACTOR and shall be removed from the site.

1.5.2 Handling Plan

Piles shall be lifted using a cradle or multiple-point pick-up to ensure that the maximum allowable stress is not exceeded due to insufficient support. One-point pick-up will not be allowed for lifting piles for safety issues. Point pick-up devices shall be of the type that clamp to the pile at each pick-up point. Piles shall not be dragged across the ground. The CONTRACTOR shall inspect piles for excessive camber and for damages before transporting them from the storage area to the driving area and immediately prior to placement in the driving leads. Camber, curvature in the pile in the direction along the pile, shall be measured with the pile laying on a flat surface and shall be the distance between the bottom of the pile at mid-length and the flat surface. Camber shall be measured in two external directions. The maximum permissible camber shall be 0.2 percent of the length of the pile. Piles having excessive camber will be rejected.

If the piles are damaged due to improper storage or handling by the CONTRACTOR, they shall be rejected and replaced by the CONTRACTOR at no expense to the Contract.

1.6 PILE SURVEY PLAN

The CONTRACTOR shall submit the proposed pile survey equipment and procedures, including the pile numbering scheme. The survey submittal shall include, at a minimum, methods and equipment to be used to measure alignment for all piling and survey methods for locating each pile head, tip, and mudline elevations for verification of location, penetration depths, and corresponding penetration resistance profiles and installation sequence methods. A complete schedule providing the theoretical location of every pile head shall be part of this plan.

PART 2 PRODUCTS

2.1 MATERIALS

2.1.1 Pipe Piles

Pipe piles shall be longitudinally welded pipe with beveled ends.

Fabricated pipe piles shall be made from bent, welded plates with staggered splices. Pipe piles shall not be spirally welded. Pile weld inspection reports shall be submitted to the ENGINEER. Acceptance and repair criteria shall conform to AWS D1.1/D1.1M.

Round structural tubes and steel piles shall be structural pipe or fabricated from structural plate. Seamless or welded pipe, with longitudinal welds and circumferential butt welds, shall conform to one of the following:

API Spec 5L PSL1 (Mill Test Reports traceable to each length of pipe) Grade X42, no spiral welds, $F_y = 42$ ksi

ASTM A 500/A 500M Grade B (Round), $F_y = 42$ ksi

Fabricated pipe shall be fabricated from one of the following plates:

ASTM A 572/A 572M Grade 42 (to 2 inch thick), $F_y = 42$ ksi

API Spec 2H Grade 42, Fy = 42 ksi

ASTM A 633/A 633M Grade A, Fy = 42 ksi

Structural pipe shall be fabricated in accordance with API Spec 2B.

2.1.2 Pile Identification and Marking

Each pile shall be clearly and indelibly marked at the top of pile with a unique identity number and length. Each pile shall be uniformly marked in one foot increments for pile driving data. These markings shall be clearly distinguishable from a safe point of observation for the pile driving inspector. A survey point of reference located immediately adjacent to the pile markings shall be provided continuously during driving operations and CONTRACTOR will confirm accuracy of survey reference point on a daily basis. The water surface shall be considered a satisfactory reference datum for the Project pile driving inspector to use as a reference datum if the CONTRACTOR obtains a survey elevation on the water surface immediately prior to driving each pile, including restrikes. The water surface elevation shall be conveyed to the Project's pile driving inspector. If water conditions are not suitable for use as the reference point during pile driving, due to wave action for instance, another means of providing a suitable means of reference must be used, as approved by ENGINEER, and noted on the pile log. The water surface shall not be used as a means of determining the final pile head elevation for compliance with driving tolerances.

2.2 FABRICATION

Steel piles shall be longitudinally welded pipe with beveled ends. Submit shop drawings of each typical pile half showing the assembled sections, welds, field splice locations, and end details to ENGINEER.

Each pile shall be clearly and indelibly marked at the top of pile with a unique identity number, length, and the date fabricated.

2.2.1 Tolerances

Steel pipe to be used for pipe piling shall conform to the following tolerances:

Thickness: In accordance with ASTM A 6/A 6M.

Diameter: The outside diameter of the steel pipe shall not vary by more than 1 percent or more than 3/8 inch from that corresponding to the diameter shown on the Plans.

Out of Round: The pipe shall not be out of round by more than 1 percent of the diameter nor more than 1/2 inch.

Straightness: Straightness of the sections of pipe shall be in accordance with AWS D1.1/D1.1M, Section 3.5.

2.2.2 Welded Splices

All welding required for the steel pipe piles shall be full penetration welds conforming to AWS D1.1/D1.1M and shall be capable of developing the

Franklin Canal Pump Station

pile in tension or bending. Welding plans and procedures shall be submitted to ENGINEER 30 days prior to the start of fabrication. Spiral welded pipe shall not be permitted.

Circumferential welds shall not project more than 1/16th of an inch. Welds exceeding this tolerance, totaling less than 5 percent of the circumference will be allowed to project up to 1/8th of an inch. Weld projections exceeding these tolerances shall be ground smooth. Visual inspections of welds shall incorporate these criteria.

All field welds shall be ground flush.

Welders and welding operators shall be approved based upon Qualification testing in conformance with AWS D1.1/D1.1M and possess necessary welder certificates. All welds shall receive 100 percent visual inspection. All automatic welds shall then receive 20 percent Radiographic Inspection (RT) or Ultrasonic Inspection (UT). All other welds shall receive either 35 percent RT or UT in conformance with AWS D1.1/D1.1M. In addition, 20 percent of all weld intersections shall be inspected as described above for a minimum of 6 inches in each direction. All inspections must be spread out evenly over the project to provide an accurate representation of all project welds.

If unacceptable discontinuities are found during these nondestructive tests, an additional 12 inches of weld on each end beyond the discontinuity shall be tested.

Automatic welding is any welding with equipment that performs the welding operation without manual manipulation of the welding arc by a welding operator. The equipment may or may not load and unload the work pieces.

A Certified Welding Inspector (CWI) shall perform all visual inspections. Technicians shall be certified to ASNT RP SNT-TC-1A, Level II, in accordance with the requirements of American Society Nondestructive Testing (ASNT), and the inspector's certificate approved by ENGINEER.

All unacceptable discontinuities shall be repaired in accordance with AWS D1.1/D1.1M. After repairs of defects have been made, the repair area plus 2 inches shall be re-inspected (UT or RT) for full compliance with the above inspection procedures.

2.2.3 Painting

Steel pipe pile shall be shop painted.

PART 3 EXECUTION

3.1 DRIVING HAMMER

Steel pipe piles shall be driven with an approved hammer. The pile hammer shall have at least the minimum rated hammer energy required to drive the steel pipe piles to the specified tip elevation shown and be capable of sustaining a driving resistance of 120 blows per foot for two consecutive feet. The pile hammers shall be sized to ensure that stresses associated with hammer impact do not exceed the allowable driving stresses specified herein:

Franklin Canal Pump Station

Compression: 0.9*F_y
Tension: 0.9*F_y

The hammer shall be maintained in proper adjustment consistent with manufacturer's recommendations and shall be operated at the manufacturer's rated number of blows per minute and at the rated pressure. The compressor shall be equipped with an accurate pressure gage. The hammer-powerpack system shall be equipped with an energy measurement system that provides an automatic printout of pile penetration, blows per foot, total blows, energy per blow and blows per minute. Pile installation shall not begin until such an energy measurement system is installed and operational.

The hammer and hammer cushion used to drive the piles shall be the same type and size as those used in the Wave Equation Analysis. The Wave Equation Analysis is to be performed by the CONTRACTOR as described herein. No modifications or substitutions will be permitted without the acceptance of ENGINEER.

Acceptance of the pile hammer relative to driving stress damage shall not relieve the CONTRACTOR of responsibility for piles damaged because of misalignment of the leads, failure of the hammer cushion, failure of splices, malfunctioning of the pile hammer, or other improper construction methods. Piles damaged for such reasons shall be rejected if the ENGINEER determines that the damage impairs the strength of the pile, and shall be replaced by the CONTRACTOR at no additional cost.

It should be noted that the minimum hammer energy requirements may not be sufficient for driving all piles at all locations to the specified tip elevation and it remains the CONTRACTOR's responsibility to attain the specified tip elevation.

The use of vibratory hammers is not allowed.

3.1.1 Air Hammers

Variable energy air/steam hammers shall be capable of providing at least two ram stroke lengths. The short ram stroke length shall be approximately half of the full stroke length for hammers with strokes up to four feet and no more than two feet for hammers with stroke lengths over four feet. Operate and maintain air/steam hammers within the manufacturer's specified ranges of pressure and speed in blows per minute. Use source(s) of air/steam to produce sufficient capacity and pressure to maintain under working conditions the volume and pressure specified by the manufacturer. Equip the plant with accurate pressure gauges which are easily accessible to ENGINEER.

3.1.2 Hydraulic Hammers

Variable energy hydraulic hammers shall have as a minimum at least three hydraulic control settings that provide for predictable stroke control. The lowest setting shall provide for a stroke of two feet or less. The remaining settings will be the highest setting and the third to be approximately halfway between the lowest and highest. The power pack system shall be equipped with an energy measurement system that provides, at a minimum, an automatic printout of; pile penetration, blows per foot, total blows, energy per blow, and blows per minute. Pile driving shall not begin until such energy measurement system is installed and operational.

3.2 DRIVING HELMET

A driving helmet shall be used between the top of the pile and the ram to prevent impact damage to the piles. The driving helmet shall be capable of transferring hammer energy uniformly over the top of the pile. Use a driving helmet deep enough to adequately contain the required thickness of hammer cushion and to assist in maintaining pile-hammer alignment. The driving helmet shall fit loosely around the top of the pile so that the pile is not restrained by the driving helmet if the pile tends to rotate during driving.

3.3 HAMMER CUSHION

Impact pile driving equipment designed to be used with a hammer cushion shall be equipped with a suitable thickness of hammer cushion material to prevent damage to the hammer and to insure uniform driving behavior. Hammer cushions shall be made of durable manufactured materials, provided in accordance with the hammer manufacturer's guidelines. Wood, wire rope, asbestos and other materials which permit excess loss of hammer energy are specifically disallowed and shall not be used as hammer cushions. A striker plate as recommended by the hammer manufacturer shall be placed on the hammer cushion to insure uniform compression of the cushion material. The hammer cushion shall be removed from the helmet and inspected in the presence of ENGINEER when beginning pile driving at each pile location or after each 100 hours of pile driving, whichever is less. Any reduction of hammer cushion thickness exceeding 50 percent of the original thickness shall be replaced by the CONTRACTOR before driving is permitted to continue. Obtain ENGINEER's approval for all proposed hammer cushion materials and proposed thickness for use.

3.4 TEMPLATES

Provide a fixed template, adequate to maintain the pile in proper position and alignment during driving with swinging leads or with semi-fixed leads. For piles on land, locate the template with 5 feet of cutoff or within 5 feet of ground line, whichever is less. For piles in water, locate the template within 5 feet of cutoff or within 5 feet of the waterline, whichever is less. Do not use floating templates (attached to a barge.) Template anchor piles shall not reduce the soil support capacity if the permanent production pipe piles on sheet piles as determined by the ENGINEER.

Where practical, place the template so that the pile can be driven to cut-off elevation before removing the template. When proposing to use a free hammer, provide a rigid double template that will independently support the pile. Provide free hammers with approved guide extensions that hold the hammer in alignment with the pile to ensure that the hammer blow is applied axially to the pile at all times.

When driving piles with a follower using floating equipment, provide a double template or other approved equipment to maintain alignment of the hammer, follower, and pile. Use a double template consisting of a pile template within 5 feet of cut-off elevation and a second upper support above the water surface for the leads. Where practical, place the template so that the pile can be driven to cut-off elevation before removing the template. Ensure that the individual pile positions of the second upper template are adjustable in size to serve as a guide for both the pile and follower. Ensure that templates do not restrict the vertical movement of the pile.

CONTRACTOR shall submit working drawings for the piling templates, supplemented by calculations as necessary that shall contain at a minimum, the following items:

Details and calculations demonstrating how to provide and maintain the specified axial alignment of the pile to within 1/8 inch per foot of pile length.

Details and calculations demonstrating adequate support and stability for the pile and template with full operating weight and dynamic loading of the proposed hammer at the top of the pile.

Provisions to provide stability and maintain alignment during placement of piles in wind, wave and current conditions.

Provisions to adequately accommodate the forces associated with or prevent the pile from running under its own weight and the weight of the hammer.

Template support piles shall be located a minimum of 8 pile diameters (larger of template pile and permanent pile diameter) net clearance from permanent pile if template pile will be pulled for removal. For template piles placed closer than clearance above template pile shall be cut-off 2' below mud line.

3.5 PILE INSTALLATION/DRIVING PLAN

Piles shall be driven to the specified tip elevations noted on the plans. Pre-augering will not be permitted. Any pile with unrepairable damage resulting from improper driving, or driven out of its proper location or alignment shall be removed. All costs associated with the removal and replacement of rejected piles shall be at the expense of the CONTRACTOR. Damaged piles that are deemed repairable by ENGINEER shall be repaired according to the CONTRACTOR's Pile Repair Plan.

The CONTRACTOR shall maintain records of pile lengths, hammer speeds, blows per foot, tip elevations and other relevant data pertinent to all piles driven. The CONTRACTOR shall provide assistance for an independent inspection of the piles, including all required equipment such as lifts, lights, work platform, measuring devices, etc., all in conformance with applicable safety regulations.

All piles shall be driven at locations shown on the Plans or as directed by ENGINEER. They shall be driven within an allowed variation of 1/8" per foot of pile length along the axial alignment as shown on the Plans. The piles shall be driven with a variation of not more than 2 inches in any direction at the cutoff elevation from the positions indicated on the Plans. Any pile driven out of position shall be corrected to the satisfaction of ENGINEER or else withdrawn and replaced. The tops of all piles shall be cut off to a true plane at the elevation shown on the Plans, or as directed by ENGINEER. Horizontal splices in pipe piles are allowable to facilitate driving and shall be in accordance with other requirements of this specification.

3.5.1 Pile Placement and Tolerances

A pile placement plan shall be developed to show the installation sequence and the methods proposed for controlling the location and alignment of piles

which shall be submitted for approval. Piles shall be placed accurately in the correct location and alignments as specified in paragraph 3.5, both laterally and longitudinally, and to the vertical lines indicated. The CONTRACTOR shall establish a permanent baseline during pile driving operations to provide for inspection of pile placement by ENGINEER. The baseline shall be established prior to driving permanent piles and shall be maintained during the installation of the permanent piles. Prior to driving, and with the pile head seated in the hammer, the CONTRACTOR shall check each pile for correct alignment. A final lateral deviation from the correct location at the cutoff elevation of not more than 2 inches will be permitted. A final vertical variation from correct top of pile elevation of not more than 1/2 inches shall be permitted. A final variation in slope of not more than 1/8 inch per foot of longitudinal axis will be permitted. The correct relative position of all piles shall be maintained by approved means. Piles not located properly or exceeding the maximum limits for lateral or vertical deviation, and/or variation in alignment shall, at the direction of the ENGINEER, be abandoned or pulled and redriven at a location specified by ENGINEER. Costs associated with abandonment, pulling and re-driving of mis-aligned piles shall be the CONTRACTOR's expense. All efforts shall be made by the CONTRACTOR to maintain driving tolerances from the start of pile installation to completion.

3.5.2 Pile Installation Plan

Submit handling, driving equipment (including followers) and wave equation analysis 60 days prior to starting work. Submit equipment for potential pre-drilling 60 days prior to starting work.

3.5.3 Driving Schedule

Submit driving schedule, including rate of driving, sequence of driving, contingency plan, and coordination with associated work.

3.5.4 Pile Survey Plan

The CONTRACTOR shall submit the proposed pile survey equipment and procedures. The survey submittal shall include, at a minimum, methods and equipment to be used to measure alignment and survey methods for locating the pile head and tip, and mudline elevations for verification of penetration depths and corresponding penetration resistance profiles and installation sequence methods. Survey information shall be used to verify penetration depths, pile locations and alignment deviations, and adequacy of installation methods.

3.5.5 Pile Repair Plan

Submit a plan to repair piles should they be damaged during transport or installation.

3.5.6 Driving Records

Pile driving records will be completed by CONTRACTOR. Pile driving records shall include pile dimensions and location, pile identification number, date driven, original pile length, cutoff and tip elevations, description of hammer used, rated hammer energy, observed stroke and rate of hammer operation (blows per minute), air pressure at the hammer or bounce chamber pressure, length of pressure hose, penetration under the combined weight of

Franklin Canal Pump Station

the pile and hammer, number of blows required for each foot of penetration throughout the entire length of each pile and for each inch of penetration in the last foot of penetration, time for start and finish of driving, total driving time in minutes and seconds for each pile, cushion information including changes during driving, and any other information such as unusual driving conditions, interruptions or delays during driving, observed pile damage, heave detected in adjacent piles, records of restriking, depth and description of voids formed adjacent to the pile, and any other pertinent information.

3.5.7 Penetration Criteria

Piles shall be driven to the required depth of penetration as shown on the drawings. The maximum permissible blow count shall be limited to 10 blows per inch, for the last 12 inches of penetration under the approved maximum hammer stroke. Based on the results of the Wave Equation Analysis, maximum permissible blow count analysis, maximum permissible blow count may be revised.

3.6 JETTING

Jetting of piles will not be permitted.

3.7 HEAVED PILES

When driving piles in clusters or under conditions of relatively close spacing, observations shall be made to detect heave of adjacent piles. Heaved piles shall be backdriven to original depth of penetration.

3.8 PLAN FOR FIELD SPLICES

The CONTRACTOR shall prepare, and submit to ENGINEER for acceptance, a plan for field splices. All welding required for the steel pipe piles shall be full penetration welds conforming to AWS D1.1/D1.1M and shall be capable of developing the pile cross section in tension and bending. The plan for field splices shall contain all field welding procedures, and shall be submitted to ENGINEER 15 days prior to the start of pile driving. It shall also contain:

Provisions for providing adequate work space, for pile welding, cutting and inspection. Facilities shall be provided for ENGINEER's inspection of the work.

Provisions shall be made for adequate alignment and support to prevent movement during field welding, and to ensure that welding tolerances are met.

Details and equipment used for handling of pile including the use of temporary supporting brackets.

Holes for lifting pipe piles are allowed only in pile cut-off allowance sections. Welding to fill holes cut in permanent pipe piles is not allowed.

Welders and welding operators performing field splices shall be approved based on Qualification Testing in conformance with AWS D1.1/D1.1M. Submit

Franklin Canal Pump Station

welder's certifications to ENGINEER. All welds shall receive 100 percent visual inspection. 50 percent of all welds splices shall then receive Radiographic Inspection (RT) or Ultrasonic Inspection (UT). All other welds shall receive either 35 percent RT or UT in conformance with AWS D1.1/D1.1M. Submit all Weld Inspection Reports results to ENGINEER. Circumferential welds shall not project more than 1/16 of an inch. Welds exceeding this tolerance, totaling less than 5 percent of the circumference will be allowed to project up to 1/8 of an inch. Weld projections exceeding these tolerances shall be ground smooth. Visual inspections of welds shall incorporate these criteria. The ENGINEER shall determine which 50 percent of weld splices are not UT or RT inspected. CONTRACTOR shall coordinate scheduling of all UT and RT with the ENGINEER.

Automatic welding is any welding with equipment that performs the welding operation without adjustment of the controls by a welding operator. The equipment may or may not load and unload the work pieces.

A Certified Welding Inspector (CWI) shall perform all visual inspections. Technicians shall be certified to ASNT RP SNT-TC-1A Level II and approved by ENGINEER. Submit the Welding Inspector Certifications to ENGINEER.

All unacceptable discontinuities shall be repaired in accordance with AWS D1.1/D1.1M. After repairs of defects have been made, the repair area plus 2 inches shall be re-inspected for full 100 percent in accordance with the above inspection procedures.

Ends of steel pipe piling to be spliced that have been damaged during driving shall be removed to a sound and uniform section conforming to the tolerances for diameter, edge alignment and roundness required to meet the steel pile splice welding requirements and the tolerances listed above. Pipe ends shall be field cut using automated guided cutting equipment. Manual flame cutting shall not be used.

3.9 WAVE EQUATION ANALYSIS

The CONTRACTOR shall submit Wave Equation Analyses, including a complete list of Pile and Driving Equipment Data to ENGINEER. The appropriate Pile Driving Equipment data form is included with this specification. Wave equation analyses shall be performed using the computer program GRLWEAP (most recent version) to size the complete pile-cushion-hammer system. The pile driving system shall be sized such that the hammer is capable of driving the pile to the specified tip elevation shown on the Plans without exceeding the allowable driving stresses for the material from which the pile is manufactured. The driving system shall provide substantial reserve capacity to the pile such that the predicted driving resistance at the specified tip elevation is on the rising portion of the plot of blow count versus ultimate capacity. Should the wave equation analyses indicate the possibility of excessive stresses, the CONTRACTOR shall submit to ENGINEER proposed corrective measures for acceptance.

This submittal shall include as a minimum, copies of computer input and output sheets and graphs showing ultimate resistance versus blow count as well as maximum tension and compression stresses versus blow count for the various subsurface conditions to be encountered on the project. Notification of acceptance or rejection of the hammer shall be made to the CONTRACTOR by ENGINEER within 14 days of the receipt of the data, the wave equation analyses and the summary report of results as specified. After receipt of

Franklin Canal Pump Station

ENGINEER's response, the CONTRACTOR will submit any and all necessary changes for acceptance. If the CONTRACTOR changes hammers, additional wave equation analyses shall be submitted before pile driving begins even if the energy ratings of the hammers are identical. However, if the substitute hammer is the same make, model, and energy as the original hammer, it may be used without performing additional wave equation analyses provided that driving performance of the first pile driven is acceptable. Additional wave equation analyses required to show that a substitute hammer is acceptable shall be done at the CONTRACTOR's expense.

3.10 TOUCH-UP PAINTING

Shop painted steel piles shall be touched-up whenever it becomes necessary to maintain the integrity of the paint film. Pile coating shall be touched up in accordance with Section 09 97 02 "PAINTING, HYDRAULIC STRUCTURES."

-- End of Section --

DIVISION 32
EXTERIOR IMPROVEMENTS

SECTION 32 11 23
GRADED – CRUSHED AGGREGATE BASE COURSE

INDEX

SECTION 32 11 23 - GRADED-CRUSHED AGGREGATE BASE COURSE

PART 1	GENERAL	2
1.1	SCOPE	2
1.2	REFERENCES.....	2
1.3	MEASUREMENT AND PAYMENT	3
1.4	SUBMITTALS.....	3
1.5	DELIVERY AND STORAGE.....	4
1.6	WEATHER LIMITATIONS.....	4
1.7	CONSTRUCTION EQUIPMENT.....	4
PART 2	PRODUCTS	4
2.1	MATERIALS.....	4
PART 3	EXECUTION	4
3.1	SURFACE COURSE	4
3.2	PLACING	5
3.3	COMPACTING AND FINISHING	5
3.4	FINISHING AT EDGES OF SURFACE COURSE	5
3.5	MAINTENANCE	6

Franklin Canal Pump Station

PART 1 GENERAL

1.1 SCOPE

The work covered by this section consists of the CONTRACTOR furnishing all labor, equipment, and materials, and performing all operations necessary for a graded crushed aggregate surface course including grading compacting and related items necessary for roadways. All as indicated in the drawings and as specified herein.

1.2 REFERENCES

The publications listed below form a part of this specification to the extent referenced. The publications are referred to within the text by the basic designation only.

AMERICAN ASSOCIATION OF STATE HIGHWAY AND TRANSPORTATION
OFFICIALS (AASHTO)

AASHTO T 180 (2010) Standard Method of Test for
Moisture-Density Relations of Soils
Using a 4.54-kg (10-lb) Rammer and a
457-mm (18-in.) Drop

AASHTO T 224 (2010) Standard Method of Test for
Correction for Coarse Particles in the
Soil Compaction Test

ASTM INTERNATIONAL (ASTM)

ASTM C117 (2004) Standard Test Method for
Materials Finer than 75-um (No. 200)
Sieve in Mineral Aggregates by Washing

ASTM C127 (2012) Standard Test Method for
Density, Relative Density (Specific
Gravity), and Absorption of Coarse
Aggregate

ASTM C128 (2012) Standard Test Method for
Density, Relative Density (Specific
Gravity), and Absorption of Fine
Aggregate

ASTM C131 (2006) Standard Test Method for
Resistance to Degradation of Small-Size
Coarse Aggregate by Abrasion and Impact
in the
Los Angeles Machine

ASTM C136 (2006) Standard Test Method for Sieve
Analysis of Fine and Coarse Aggregates

ASTM C29/C29M (2009) Standard Test Method for
Bulk Density ("Unit Weight") and
Voids in Aggregate

Franklin Canal Pump Station

ASTM C88	(2005) Standard Test Method for Soundness of Aggregates by Use of Sodium Sulfate or Magnesium Sulfate
ASTM D1556	(2007) Density and Unit Weight of Soil in Place by the Sand-Cone Method
ASTM D1557	(2012) Standard Test Methods for Laboratory Compaction Characteristics of Soil Using Modified Effort (56,000 ft-lbf/ft ³) (2700 kN-m/m ³)
ASTM D2167	(2008) Density and Unit Weight of Soil in Place by the Rubber Balloon Method
ASTM D2487	(2011) Soils for Engineering Purposes (Unified Soil Classification System)
ASTM D422	(1963; R 2007) Particle-Size Analysis of Soils
ASTM D4318	(2010) Liquid Limit, Plastic Limit, and Plasticity Index of Soils
ASTM D5821	(2001; R 2006) Standard Test Method for Determining the Percentage of Fractured Particles in Coarse Aggregate
ASTM D6938	(2010) Standard Test Method for In-Place Density and Water Content of Soil and Soil-Aggregate by Nuclear Methods (Shallow Depth)
ASTM D75/D75M	(2009) Standard Practice for Sampling Aggregates
ASTM E11	(2009; E 2010) Wire Cloth and Sieves for Testing Purposes

1.3 MEASUREMENT AND PAYMENT

Measure the quantity of graded-crushed aggregate completed and accepted, as determined by the ENGINEER, in cubic yards. The volume of material in-place and accepted will be determined by the load/haul ticket as provided by supplier.

Quantities of graded-crushed aggregate, determined as specified above, will be paid for at the contract unit price for Bid Item: "Limestone Surface Course," which shall constitute full compensation for the construction and completion of the graded-crushed aggregate.

1.4 SUBMITTALS

Aggregate gradation reports shall be submitted and approved prior to hauling any material onto the project site.

Franklin Canal Pump Station

1.5 DELIVERY AND STORAGE

Inspect materials delivered to site and store as to prevent segregation and contamination.

1.6 WEATHER LIMITATIONS

Do not construct surface course when rainfall or other weather conditions detrimentally affect the quality of the finished course.

1.7 CONSTRUCTION EQUIPMENT

Equipment shall be dependable and adequate for the purpose intended. Maintain equipment in satisfactory and safe operating condition. Subject to approval, special equipment dictated by local conditions may be used.

PART 2 PRODUCTS

2.1 MATERIALS

Aggregates shall consist of durable and sound crushed stone, free of lumps or balls of clay or other objectionable matter and shall meet the requirements of the Louisiana Department of Transportation and Development (LaDOTD) *Louisiana Standard Specifications for Roads and Bridges* Item No. 1003.04 (a). Crushed stone shall be free from flat, elongated, soft, or disintegrated pieces. Determine grain size in accordance with ASTM C 136 and amount of material finer than 200 mesh sieve in accordance with ASTM C 117. Soil binder material, that portion of material passing the No. 40 sieve, shall be of such composition that the composite material conforms to the requirements specified herein. The surface course shall be of such nature that it can be compacted readily with watering and rolling to a firm, stable base and shall conform to the following sizes:

Percentage by Weight Passing
Square Mesh Laboratory Sieves

<u>U. S. Sieve</u>	<u>Percent Passing</u>
1 ½ inch	100
¾ inch	50 - 100
No. 4	35 - 65
No. 40	10 - 32
No. 200	3 - 15

That fraction of stone passing the No. 40 sieve shall have a liquid limit of not more than 25 and a plasticity index of not more than 4 as determined by ASTM D 4318.

PART 3 EXECUTION

3.1 SURFACE COURSE

Franklin Canal Pump Station

Construct the graded aggregate surface course on a previously constructed subbase, as indicated. Provide line and grade stakes for control. Place grade stakes in lanes parallel to the centerline of areas to be paved and space for string lining or other control methods. The surface course shall consist of aggregate processed, deposited, spread, and compacted on a prepared surface. The CONTRACTOR shall be responsible for protection of completed areas against detrimental effects. Recondition, reshape, and recompact areas damaged by rainfall or other weather conditions.

3.2 PLACING

Do not dump mixed materials in piles, but place on prepared subgrade or subbase in layers of uniform thickness with a spreader or approved spreading equipment. When a compacted course 6 inches in thickness is required, place material in a single layer. When a compacted course in excess of 6 inches is required, place material in layers of equal thickness. Do not exceed 6 inches or have less than 3 inches in thickness for any compacted layer. Place layers so that when compacted, they will be true to grades or levels required with the least possible surface disturbance. Where the surface course is constructed in more than one layer, clean previously constructed layers of loose and foreign matter. Maintain material water content during the placing period to obtain the compaction specified. Make adjustments in placing procedures or equipment to obtain true grades, to minimize segregation and degradation, to reduce or increase water content, and to insure a satisfactory surface course.

3.3 COMPACTING AND FINISHING

Immediately following the placing, spread the finished mixture uniformly in a layer and bring to optimum moisture content. The loose thickness and the surface of the layer shall be such that the specified density and the required thickness shall be obtained after compaction. Compact the layer with steel-faced, vibrating or pneumatic-tired rollers, or other suitable compacting equipment or combinations thereof. Surface course shall be shaped to the section as shown on the Plans and compacted to 75% relative density as per ASTM D-4253 and ASTM D-4252. In areas not accessible to rollers or compactors, compact the mixture with mechanical hand tampers. If the mixture is excessively moistened by rain, aerate by blade graders, or other suitable equipment. Aerate until the moisture content of the material is that needed to obtain the required density. Finish the surface of the layer by a combination of rolling and blading. Final surface shall be smooth and free from waves, irregularities, and ruts or soft yielding spots.

3.4 FINISHING AT EDGES OF SURFACE COURSE

Place earth or other approved materials along the edges of the surface course in such quantity that it will compact to the thickness of the course being constructed. When the course is being constructed in two or more layers, place material to the thickness of each layer. In each operation, allow at least a one foot width of the shoulder to be rolled and compacted simultaneously with the rolling and compacting of each layer.

3.5 MAINTENANCE

After construction is completed, maintain the surface course throughout, except where portion of the succeeding course is under construction thereon. Maintenance includes drainage, rolling, shaping, and watering, as necessary, to maintain the course in proper condition. Correct deficiencies in thickness, composition, construction, smoothness, and density, which develop during the maintenance, to conform to the requirements specified herein. Maintain sufficient moisture by light sprinkling with water at the surface to prevent a dusty condition.

-- End of Section --

SECTION 32 92 19.00 12
FERTILIZING AND SEEDING

INDEX

SECTION 32 92 19.00 12 - FERTILIZING AND SEEDING

PART 1 GENERAL..... 2

1.1 SCOPE2

1.2 REFERENCES2

1.3 MEASUREMENT AND PAYMENT2

1.4 SUBMITTALS2

1.5 QUALITY CONTROL3

1.5.1 General3

1.5.2 Reporting3

1.6 AREAS TO BE TREATED3

1.7 COMMENCEMENT, PROSECUTION, AND COMPLETION4

1.7.1 General4

1.7.2 Sequence of Work4

PART 2 PRODUCTS..... 4

2.1 MATERIALS4

2.1.1 Fertilizer4

2.1.2 Soil for Repairs4

2.1.3 Seed4

2.1.4 Water5

PART 3 EXECUTION..... 5

3.1 PREPARATION OF GROUND SURFACE5

3.1.1 General5

3.1.2 Clearing5

3.1.3 Grading5

3.1.4 Tillage5

3.2 APPLICATION OF FERTILIZER6

3.3 SEEDING6

3.3.1 General6

3.3.2 Broadcast Seeding6

3.3.3 Hydraulic Seeding6

3.3.4 Damage to Seeding6

3.4 MOWING6

3.5 WATERING7

SECTION 32 92 19.00 12

FERTILIZING AND SEEDING

PART 1 GENERAL

1.1 SCOPE

The work provided for herein consists of furnishing all plant, labor, equipment and materials, and performing all operations necessary for finished dressing, fertilizing and seeding areas as specified herein and as indicated on the drawings. Fertilizing and seeding of the new embankment shall be performed upon completion of embankment construction in minimum lengths of 300-feet. The period of the year in which fertilizing and seeding operations are performed in a particular area will determine the seeding specification in Table I which shall be followed for that area. Only one of the seeding specifications listed in Table I will be required for each particular area.

1.2 REFERENCES

NOT USED

1.3 MEASUREMENT AND PAYMENT

Measurement for fertilizing and seeding satisfactorily performed will be made by the acre. Acreage will be determined from surface areas computed from the theoretical gross cross section of embankment fertilized and seeded. Measurement will be to the nearest foot and units computed to the nearest one-hundredth of an acre. No measurement will be made for placement of material required for any necessary repairs as described in paragraph 3.1.3 "Grading."

Payment for fertilizing and seeding measured as described in paragraph 1.3 "MEASUREMENT" and other incidental work, except disposal of debris, will be made at the contract price per acre for Bid Item: "Seeding and Fertilizing." Prices and payments shall constitute full compensation for furnishing all plant, labor, materials and equipment and performing the work, including any necessary repairs, in accordance with these specifications.

1.4 SUBMITTALS

SD-03 Product Data

Fertilizer

Duplicate signed copies of invoices from suppliers shall be furnished. Invoices shall show quantities and percentage of nitrogen, phosphorus, and potash. Upon completion of the project, a final check of the total quantity of fertilizer used will be made against total area treated, and if minimum rates of application have not been met, an additional quantity of material sufficient to make up the minimum application rate shall be distributed as directed.

SD-07 Certificates

Franklin Canal Pump Station

Seed

The ENGINEER shall be furnished duplicate signed copies of statements certifying that each container of seed delivered is labeled in accordance with the Federal Seed Act and is at least equal to the requirements specified in paragraph 2.1.3 "Seed." This certification shall be obtained from the supplier and shall be furnished on or with all copies of seed invoices.

1.5 QUALITY CONTROL

1.5.1 General

The CONTRACTOR shall establish and maintain quality control for finished dressing, fertilizing, and seeding operations and shall maintain records of his quality control for all construction operations including, but not limited to, the following:

Preparation of Ground Surface

Location and quality of finished dressing, including necessary clearing, filling, or dressing out of washes, smoothness and uniformity of surfaces, and time of year.

Fertilizing

Quality of materials. Areas fertilized quantity applied, and method of application.

Seeding

Quality and type of seed, area covered, rate of application, quantity of seed used, and method of distribution.

Maintenance and Repair

Location and type of maintenance problems and remedial treatment performed.

Watering

Quality of water, area watered, quantity applied, and method of application.

1.5.2 Reporting

The original and two copies of these records of inspections and tests, as well as the records of corrective action taken, shall be furnished by the CONTRACTOR daily. Format of the report shall be as prescribed in General Conditions.

1.6 AREAS TO BE TREATED

Fertilizing and seeding shall be performed on all disturbed areas within the construction limits and on all newly constructed embankments as indicated on the drawings.

Franklin Canal Pump Station

1.7 COMMENCEMENT, PROSECUTION, AND COMPLETION

1.7.1 General

Preparation of the ground surface, fertilizing, and seeding operations shall be accomplished during the applicable growing season as specified in Table I.

1.7.2 Sequence of Work

The sequence of operations for work prescribed in this section, except mowing, shall be as follows:

Preparation of Ground Surface.

Fertilizing.

Seeding.

Watering.

Fertilizing and seeding operations shall commence upon completion of embankment construction, a length of 1,000 feet of embankment. At no time shall such fertilizing and seeding operations be more than 1,000 feet behind completed portions of embankment unless approved by the ENGINEER.

PART 2 PRODUCTS

2.1 MATERIALS

2.1.1 Fertilizer

Fertilizer shall be uniform in composition and free flowing. The fertilizer shall meet the requirements for commercial fertilizer and shall contain, per acre, 60 pounds of available nitrogen, 60 pounds of available phosphorous, and 60 pounds of available potash. The fertilizer shall be delivered to the site in bags or other convenient containers or delivered in bulk. If delivered in bags or containers, the fertilizer shall be fully labeled in accordance with the applicable state fertilizer laws and shall bear the name, trade name or trademark, and warranty of the producer. Should the commercial fertilizer be furnished in bulk, the CONTRACTOR shall furnish certified weight tickets and a certified quantitative analysis report, in triplicate, from a recognized testing laboratory certifying the nutrient ratio of the materials.

2.1.2 Soil for Repairs

For fill of areas to be repaired, soil shall be of a quality at least equal to that which exists in areas adjacent to the area to be repaired. Soil used shall be relatively free from roots, stones, and other materials that hinder grading, planting, and maintenance operations and shall be free from objectionable weed seeds and toxic substances.

2.1.3 Seed

Seed labeled in accordance with U.S. Department of Agriculture Rules and Regulations under the Federal Seed Act shall be furnished by the CONTRACTOR.

Franklin Canal Pump Station

Seed shall be furnished in sealed, standard containers unless written exception is granted. Seed that is wet or moldy or that has been otherwise damaged in transit or storage will not be acceptable. The specifications for seeds shall conform to, and be seeded in accordance with the following table:

Table I

<u>Seeding Period and Grasses to be Used</u>	<u>Minimum Purity %</u>	<u>Minimum Germination %</u>	<u>Minimum Rate Lbs/Acre</u>
2 March - 14 September Hulled Common Bermuda grass	95	87	50
15 September - 1 March Unhulled Common Bermuda grass	95	87	50
Ryegrass	97	82	35

2.1.4 Water

Water shall be free from oil, acid, alkali, salt, and other substances harmful to growth of grass.

PART 3 EXECUTION

3.1 PREPARATION OF GROUND SURFACE

3.1.1 General

Equipment, in good condition, shall be provided for the proper preparation of the ground and for handling and placing all materials. Equipment shall be approved by the ENGINEER before work is started.

3.1.2 Clearing

Prior to grading and tilling, vegetation and debris that may interfere with fertilizing and seeding operations shall be mowed, grubbed, and raked; and shall be disposed of satisfactorily, as specified in Section 31 11 00.00 12 CLEARING AND GRUBBING.

3.1.3 Grading

Previously established grades and slopes shall be maintained in a true and even condition on the areas to be fertilized and seeded. Necessary repairs to previously graded areas shall be repaired with material as described in paragraph 2.1.2 "Soil for Repairs." Where grades have not been established, the areas shall be graded as shown, or as directed by the ENGINEER, and all surfaces shall be left in a true and even condition.

3.1.4 Tillage

After the areas required to be fertilized and seeded have been brought to the specified grades, the soil shall be tilled to a depth of at least 2-inches by plowing, disking, harrowing, or other approved method until the condition of the soil is acceptable. The work shall be performed only during periods when, in the opinion of the ENGINEER, beneficial results are likely

Franklin Canal Pump Station

to be obtained. When drought, excessive moisture, or other unsatisfactory conditions prevail, the work shall be stopped when directed. Undulations or irregularities in the surface to be fertilized and seeded shall be dressed before the next specified operation.

3.2 APPLICATION OF FERTILIZER

Fertilizer, as specified in paragraph 2.1.1 "Fertilizer," shall be distributed uniformly over areas to be seeded and shall be incorporated into the soil to a depth of at least 2-inches by disking, harrowing, or other acceptable methods. Incorporation of fertilizer may be part of the operation specified in paragraph 3.1.4 "Tillage."

3.3 SEEDING

3.3.1 General

The applicable seed shall be sown at the rate and time as indicated in Table I, unless otherwise directed in writing. A satisfactory method of sowing shall be employed; using approved mechanical power-drawn seeders, mechanical hand- seeders, broadcast-seeders, or other approved methods. When delays in operations extend the work beyond the most favorable planting season for the species designated, or when conditions are such by reason of drought, high winds, excessive moisture, or other factors that satisfactory results are not likely to be obtained, work shall be halted as directed by the ENGINEER and resumed only when conditions are favorable or when approved alternative or corrective measures and procedures have been effected. If inspection during or after seeding operations indicates that areas have been left unplanted or other areas have been skipped, additional seed shall be applied at no additional cost to the OWNER.

3.3.2 Broadcast Seeding

If the broadcast method of seeding is used, seed shall be broadcast with approved sowing equipment and distributed uniformly over designated areas. Seed shall be covered to an average depth of 2-inch. Seed shall not be broadcast during windy weather.

3.3.3 Hydraulic Seeding

If the hydraulic method of seeding is used, seeds shall be combined with fertilizer and mulch and applied uniformly with equipment meeting the requirements of Part 2.1.

3.3.4 Damage to Seeding

The CONTRACTOR shall be fully responsible for any damage to the seeded areas caused by his operations. Areas that become damaged as a result of poor workmanship or failure to meet the requirements of the specifications may be ordered repaired and reseeded to specification requirements, without additional cost to the OWNER.

3.4 MOWING

The seeded areas shall be mowed with approved mowing equipment to a height of 3 to 4-inches whenever the height of vegetation becomes 6 to 8-inches.

Franklin Canal Pump Station

When the amount of cut grass is heavy, it shall be removed to prevent destruction of the underlying turf. The CONTRACTOR shall perform periodic and final grass mowing within the limits of work for the duration of this contract.

3.5 WATERING

The fertilizer and seeded areas shall be watered with potable water weekly until the final acceptance of the Contract.

-- End of Section --

DIVISION 33
UTILITIES

SECTION 33 11 23
GASLINE

INDEX
SECTION 33 11 23 GASLINE

PART 1	GENERAL.....	2
1.1	SCOPE	2
1.2	REFERENCES	2
1.3	MEASUREMENT AND PAYMENT.....	4
1.4	SUBMITTALS	4
1.5	QUALITY ASSURANCE	5
1.5.1	Welder's Qualifications.....	5
1.5.2	PE Welder's Qualifications.....	5
1.5.3	Safety Standards.....	5
1.6	DELIVERY, STORAGE, AND HANDLING	5
PART 2	PRODUCTS.....	5
2.1	MATERIALS AND EQUIPMENT	5
2.2	PIPE AND FITTINGS	6
2.2.1	Aboveground and Within Buildings and Vaults.....	6
2.2.2	Underground Polyethylene (PE).....	6
2.2.3	Risers.....	6
2.2.4	Transition Fittings.....	6
2.3	VALVES, ABOVEGROUND	6
2.3.1	Shutoff Valves, Sizes Larger Than 2 Inches.....	7
2.3.2	Shutoff Valves, Sizes 2 Inches and Smaller.....	7
2.3.3	Pressure Regulator.....	7
2.4	GAS METER	7
2.5	GAS EQUIPMENT CONNECTORS	7
2.6	CASING	7
2.7	BURIED UTILITY WARNING AND IDENTIFICATION TAPE	7
2.8	HANGERS AND SUPPORTS	7
2.9	WELDING FILLER METAL	8
2.10	PIPE-THREAD TAPE.....	8
2.11	BOLTING (BOLTS AND NUTS).....	8
2.12	GASKETS.....	8
2.13	IDENTIFICATION FOR ABOVEGROUND PIPING.....	8
PART 3	EXECUTION.....	8
3.1	INSTALLATION	8
3.1.1	Excavating and Backfilling.....	8
3.1.2	Piping.....	9
3.1.2.1	Cleanliness	9
3.1.2.2	Aboveground Steel Piping	9
3.1.2.3	Buried Plastic Lines	10
3.1.2.4	Connections to Existing Pipeline	10
3.1.2.5	Wrapping	10
3.1.3	Valves.....	10
3.1.3.1	Pressure Regulator	10
3.1.3.2	Stop Valve and Shutoff Valve	10
3.1.4	Pipe Sleeves.....	11
3.1.5	Piping Hangers and Supports.....	11
3.1.6	Final Connections.....	11
3.1.6.1	Domestic Water Heaters	11
3.2	FIELD QUALITY CONTROL	11
3.2.1	Metal Welding Inspection.....	11
3.2.2	PE Fusion Welding Inspection.....	11
3.2.3	Pressure Tests.....	11
3.2.4	System Purging.....	12

PART 1 GENERAL

1.1 SCOPE

The work covered by this section consists of the CONTRACTOR furnishing all labor, equipment, and materials, and performing all operations necessary for installing the gaslines including meters, valves, and other accessories as indicated in the drawings and as specified herein.

1.2 REFERENCES

The publications listed below form a part of this specification to the extent referenced. The publications are referred to within the text by the basic designation only.

AMERICAN GAS ASSOCIATION (AGA)

AGA ANSI B109.1 (2000) Diaphragm-Type Gas Displacement Meters (Under 500 cubic ft./hour Capacity)

AGA ANSI B109.2 (2000) Diaphragm-Type Gas Displacement Meters (500 cubic ft./hour Capacity and Over)

AGA ANSI B109.3 (2000) Rotary-Type Gas Displacement Meters

AMERICAN NATIONAL STANDARDS INSTITUTE (ANSI)

ANSI Z21.41/CSA 6.9 (2011) Quick-Disconnect Devices for Use with Gas Fuel Appliances

ANSI Z21.45 (1995) Flexible Connectors of Other Than All-Metal Construction for Gas Appliances

ANSI Z21.69/CSA 6.16 (2009; Addenda A 2012) Connectors for Movable Gas Appliances

AMERICAN SOCIETY OF CIVIL ENGINEERS (ASCE)

ASCE 25-06 (2008) Earthquake-Activated Automatic Gas Shutoff Devices

ASME INTERNATIONAL (ASME)

ASME B1.1 (2003; R 2008) Unified Inch Screw Threads (UN and UNR Thread Form)

ASME B1.20.1 (1983; R 2006) Pipe Threads, General Purpose (Inch)

ASME B16.11 (2011) Forged Fittings, Socket-Welding and Threaded

ASME B16.3 (2011) Malleable Iron Threaded Fittings, Classes 150 and 300

ASME B16.33 (2012) Manually Operated Metallic Gas Valves for Use in Gas Piping Systems Up to

125 psi, Sizes NPS 1/2 - NPS 2

- ASME B16.38 (2012) Large Metallic Valves for Gas Distribution (Manually Operated, NPS 2 1/2 to 12, 125 psig Maximum)
- ASME B16.39 (2009) Standard for Malleable Iron Threaded Pipe Unions; Classes 150, 250, and 300
- ASME B16.40 (2008) Manually Operated Thermoplastic Gas Shutoffs and Valves in Gas Distribution Systems
- ASME B16.5 (2009) Pipe Flanges and Flanged Fittings: NPS 1/2 Through NPS 24 Metric/Inch Standard
- ASME B16.9 (2012) Standard for Factory-Made Wrought Steel Buttwelding Fittings
- ASME B18.2.1 (2010) Square and Hex Bolts and Screws (Inch Series)
- ASME B18.2.2 (2010) Standard for Square and Hex Nuts
- ASME B31.8 (2013) Gas Transmission and Distribution Piping Systems
- ASME BPVC SEC VIII D1 (2010) BPVC Section VIII-Rules for Construction of Pressure Vessels Division 1

ASTM INTERNATIONAL (ASTM)

- ASTM A193/A193M (2012a) Standard Specification for Alloy-Steel and Stainless Steel Bolting Materials for High-Temperature Service and Other Special Purpose Applications
- ASTM A194/A194M (2012a) Standard Specification for Carbon and Alloy Steel Nuts for Bolts for High-Pressure or High-Temperature Service, or Both
- ASTM A53/A53M (2012) Standard Specification for Pipe, Steel, Black and Hot-Dipped, Zinc-Coated, Welded and Seamless
- ASTM D2513 (2012a; E 2012) Thermoplastic Gas Pressure Pipe, Tubing, and Fittings
- ASTM D2683 (2010) Standard Specification for Socket-Type Polyethylene Fittings for Outside Diameter-Controlled Polyethylene Pipe and Tubing

MANUFACTURERS STANDARDIZATION SOCIETY OF THE VALVE AND FITTINGS INDUSTRY (MSS)

- MSS SP-58 (2009) Pipe Hangers and Supports -

Materials, Design and Manufacture,
Selection, Application, and Installation

MSS SP-69 (2003; Notice 2012) Pipe Hangers and
Supports - Selection and Application (ANSI
Approved American National Standard)

NATIONAL FIRE PROTECTION ASSOCIATION (NFPA)

NFPA 54 (2012) National Fuel Gas Code

NFPA 58 (2011; TIA 10-1; Errata 10-1; TIA 11-2;
TIA 11-3; Errata 11-2; Errata 12-3)
Liquefied Petroleum Gas Code

SHEET METAL AND AIR CONDITIONING CONTRACTORS' NATIONAL ASSOCIATION
(SMACNA)

SMACNA 1981 (2008) Seismic Restraint Manual Guidelines
for Mechanical Systems, 3rd Edition

U.S. DEPARTMENT OF DEFENSE (DOD)

MIL-STD-101 (1970; Rev B) Color Code for Pipelines &
for Compressed Gas Cylinders

U.S. NATIONAL ARCHIVES AND RECORDS ADMINISTRATION (NARA)

49 CFR 192 Transportation of Natural and Other Gas by
Pipeline: Minimum Federal Safety Standards

1.3 MEASUREMENT AND PAYMENT

No separate measurement will be made for the material and work covered under
this section. Payment will be included in the contract lump sum for Bid Item:
"Natural Gas Supply."

1.4 SUBMITTALS

ENGINEER approval is required for submittals with an "E" designation;
submittals not having designation are for information only. The following
shall be submitted;

SD-03 Product Data

Valve box

Pressure regulator

Gas equipment connectors

Valves

Warning and identification tape

Risers

Transition fittings

Gas meter

LPG containers and accessories

SD-07 Certificates

Welder's qualifications

PE welder's qualifications

Welder's identification symbols

SD-08 Manufacturer's Instructions

PE pipe and fittings, E

Submit manufacturer's installation instructions and manufacturer's visual joint appearance chart.

1.5 QUALITY ASSURANCE

1.5.1 Welder's Qualifications

Comply with ASME B31.8. The steel welder shall have a copy of a certified ASME B31.8 qualification test report. The PE welder shall have a certificate from a PE pipe manufacturer's sponsored training course. CONTRACTOR shall also conduct a qualification test. Submit each welder's identification symbols, assigned number, or letter, used to identify work of the welder. Affix symbols immediately upon completion of welds. Welders making defective welds after passing a qualification test shall be given a requalification test and, upon failing to pass this test, shall not be permitted to work this contract.

1.5.2 PE Welder's Qualifications

Prior to installation, CONTRACTOR shall have supervising and installing personnel trained by a PE pipe manufacturer's sponsored course of not less than one week duration, or present proof satisfactory to the ENGINEER that personnel are currently working in the installation of PE gas distribution lines.

1.5.3 Safety Standards

49 CFR 192.

1.6 DELIVERY, STORAGE, AND HANDLING

Handle, transport, and store plastic pipe and fittings carefully. Plug or cap pipe ends during transportation or storage to minimize dirt and moisture entry. Do not subject to abrasion or concentrated external loads. Discard PE pipe sections and fittings that have been damaged.

PART 2 PRODUCTS

2.1 MATERIALS AND EQUIPMENT

Conform to NFPA 54 and with requirements specified herein. Supply piping to appliances or equipment shall be at least as large as the inlets thereof.

2.2 PIPE AND FITTINGS

2.2.1 Aboveground and Within Buildings and Vaults

- a. Pipe: Black steel in accordance with **ASTM A53/A53M**, Schedule 40 threaded ends for sizes **2 inches** and smaller; otherwise, plain end beveled for butt welding.
- b. Threaded Fittings: **ASME B16.3**, black malleable iron.
- c. Socket-Welding Fittings: **ASME B16.11**, forged steel.
- d. Butt-Welding Fittings: **ASME B16.9**, with backing rings of compatible material.
- e. Unions: **ASME B16.39**, black malleable iron.
- f. Flanges and Flanged Fittings: **ASME B16.5** steel flanges or convoluted steel flanges conforming to **ASME BPVC SEC VIII D1**. Flange faces shall have integral grooves of rectangular cross sections which afford containment for self-energizing gasket material.

2.2.2 Underground Polyethylene (PE)

PE pipe and fittings are as follows:

- a. Pipe: **ASTM D2513**, **100 psig** working pressure, Standard Dimension Ratio (SDR), the ratio of pipe diameter to wall thickness, **11.5** maximum.
- b. Socket Fittings: **ASTM D2683**.
- c. Butt-Fusion Fittings: **ASTM D2513**, molded.

2.2.3 Risers

Manufacturer's standard riser, transition from plastic to steel pipe with **7 to 12 mil** thick epoxy coating. Use swaged gas-tight construction with O-ring seals, metal insert, and protective sleeve. Provide remote bolt-on or bracket riser supports as indicated.

2.2.4 Transition Fittings

- a. Steel to Plastic (PE): As specified for "riser" except designed for steel-to-plastic with tapping tee or sleeve. Coat or wrap exposed steel pipe with heavy plastic coating.
- b. Plastic to Plastic: Manufacturer's standard bolt-on (PVC to PE) plastic tapping saddle tee, UL listed for gas service, rated for **100 psig**, and O-ring seals. Manufacturer's standard slip-on PE mechanical coupling, molded, with stainless-steel ring support, O-ring seals, and rated for **150 psig** gas service. Manufacturer's standard fused tapping (PE-to-PE) tee assembly with shut-off feature.

2.3 VALVES, ABOVEGROUND

Provide lockable valves at meter.

Franklin Canal Pump Station

2.3.1 Shutoff Valves, Sizes Larger Than 2 Inches

Steel body ball valve with flanged ends in accordance with [ASME B16.38](#).
Provide PTFE seats.

2.3.2 Shutoff Valves, Sizes 2 Inches and Smaller

Steel body ball valve in accordance with [ASME B16.33](#), full port pattern, reinforced PTFE seals, threaded ends, and PTFE seat.

Steel body plug valve in accordance with [ASME B16.33](#), straightway, taper plug, regular pattern with a port opening at least equal to the internal pipe area or round port full bore pattern, non-lubricated, PTFE packing, flat or square head stem with lever operator, [125 psig](#) rating, threaded ends.

2.3.3 Pressure Regulator

Self-contained with spring-loaded diaphragm pressure regulator, [psig](#) to [inches](#) water reduction, pressure operating range as required for the pressure reduction indicated, volume capacity not less than indicated, and threaded ends for sizes [2 inches](#) and smaller, otherwise flanged.

2.4 GAS METER

Gas meter shall be supplied by the utility company.

2.5 GAS EQUIPMENT CONNECTORS

- a. Flexible Connectors: [ANSI Z21.45](#).
- b. Quick Disconnect Couplings: [ANSI Z21.41/CSA 6.9](#).
- c. Semi-Rigid Tubing and Fittings: [ANSI Z21.69/CSA 6.16](#).

2.6 CASING

Where indicated at railroad or other crossing, provide [ASTM A53/A53M](#), galvanized pipe, Schedule 40, with extruded polyethylene coating.

2.7 BURIED UTILITY WARNING AND IDENTIFICATION TAPE

Provide detectable aluminum-foil plastic-backed tape or detectable magnetic plastic tape manufactured specifically for warning and identification of buried piping. Tape shall be detectable by an electronic detection instrument. Provide tape in rolls, [3 inch](#) minimum width, color-coded yellow for natural gas, with warning and identification imprinted in bold black letters continuously and repeatedly over entire tape length. Warning and identification shall be "CAUTION BURIED GAS PIPING BELOW" or similar wording. Use permanent code and letter coloring unaffected by moisture and other substances contained in trench backfill material.

2.8 HANGERS AND SUPPORTS

[MSS SP-58](#), as required by [MSS SP-69](#). Hangers and supports to allow for 4 inches of floodwall and walkway lateral movement relative to pipe. Hangers and supports to be coordinated with Electrical Conduit as specified in 20 00 00.00 20 ELECTRICAL GENERAL.

2.9 WELDING FILLER METAL

ASME B31.8.

2.10 PIPE-THREAD TAPE

Antiseize and sealant tape of polytetrafluoroethylene (PTFE).

2.11 BOLTING (BOLTS AND NUTS)

Stainless steel bolting; ASTM A193/A193M, Grade B8M or B8MA, Type 316, for bolts; and ASTM A194/A194M, Grade 8M, Type 316, for nuts. Dimensions of bolts, studs, and nuts shall conform with ASME B18.2.1 and ASME B18.2.2 with coarse threads conforming to ASME B1.1, with Class 2A fit for bolts and studs and Class 2B fit for nuts. Bolts or bolt-studs shall extend through the nuts and may have reduced shanks of a diameter not less than the diameter at root of threads. Bolts shall have American Standard regular square or heavy hexagon heads; nuts shall be American Standard heavy semifinished hexagonal.

2.12 GASKETS

Fluorinated elastomer, compatible with flange faces.

2.13 IDENTIFICATION FOR ABOVEGROUND PIPING

MIL-STD-101 for legends and type and size of characters. For pipes $\frac{3}{4}$ inch od and larger, provide printed legends to identify contents of pipes and arrows to show direction of flow. Color code label backgrounds to signify levels of hazard. Make labels of plastic sheet with pressure-sensitive adhesive suitable for the intended application. For pipes smaller than $\frac{3}{4}$ inch od, provide brass identification tags 1 1/2 inches in diameter with legends in depressed black-filled characters.

PART 3 EXECUTION

3.1 INSTALLATION

Install gas piping, appliances, and equipment in accordance with NFPA 54. Install and store liquefied petroleum gas piping, appliances, and equipment in accordance with NFPA 58.

3.1.1 Excavating and Backfilling

Place backfill on sub-grades free of mud, frost, snow, or ice. Place and compact bedding course on trench bottoms and where indicated. Shape bedding course to provide continuous support for bells, joints, and barrels of pipes and for joints, fittings, and bodies of conduits. Backfill trenches excavated under footings and within 18 inches of bottom of footings with satisfactory soil; fill with concrete to elevation of bottom of footings. Provide 4-inch thick, concrete-base slab support for piping or conduit less than 30 inches below surface of roadways. After installing and testing, completely encase piping or conduit in a minimum of four (4) inches of concrete before backfilling or placing roadway sub-base. Place and compact initial backfill with satisfactory soil, free of particles larger than one (1) inch in any dimension, to a height of 12 inches over the utility pipe or conduit. Carefully compact initial backfill under pipe haunches and compact evenly up on both sides and along the full length of utility piping or conduit to avoid

damage or displacement of piping or conduit. Coordinate backfilling with utilities testing. Place and compact final backfill of satisfactory soil to final sub-grade elevation. Install warning tape directly above utilities, 12 inches below finished grade, except six (6) inches below sub-grade under pavements and slabs.

3.1.2 Piping

Cut pipe to actual dimensions and assemble to prevent residual stress. Provide supply connections entering the buildings as indicated. Within buildings, run piping parallel to structure lines and conceal in finished spaces. Terminate each vertical supply pipe to burner or appliance with tee, nipple and cap to form a sediment trap. To supply multiple items of gas-burning equipment, provide manifold with inlet connections at both ends.

3.1.2.1 Cleanliness

Clean inside of pipe and fittings before installation. Blow lines clear using 80 to 100 psig clean dry compressed air. Rap steel lines sharply along entire pipe length before blowing clear. Cap or plug pipe ends to maintain cleanliness throughout installation.

3.1.2.2 Aboveground Steel Piping

Determine and establish measurements for piping at the job site and accurately cut pipe lengths accordingly. For 50 mm 2 inch diameter and smaller, use threaded or socket-welded joints. For 65 mm 2 1/2 inch diameter and larger, use flanged or butt-welded joints.

- a. Threaded Joints: Where possible use pipe with factory-cut threads, otherwise cut pipe ends square, remove fins and burrs, and cut taper pipe threads in accordance with ASME B1.20.1. Provide threads smooth, clean, and full-cut. Apply anti-seize paste or tape to male threads portion. Work piping into place without springing or forcing. Backing off to permit alignment of threaded joints will not be permitted. Engage threads so that not more than three threads remain exposed. Use unions for connections to valves and meters for which a means of disconnection is not otherwise provided.
- b. Welded Joints: Weld by the shielded metal-arc process, using covered electrodes and in accordance with procedures established and qualified in accordance with ASME B31.8.
- c. Flanged Joints: Use flanged joints for connecting welded joint pipe and fittings to valves to provide for disconnection. Install joints so that flange faces bear uniformly on gaskets. Engage bolts so that there is complete threading through the nuts and tighten so that bolts are uniformly stressed and equally torqued.
- d. Pipe Size Changes: Use reducing fittings for changes in pipe size. Size changes made with bushings will not be accepted.
- e. Painting: Paint new ferrous metal piping, including supports, in accordance with Section 09 97 02 PAINTING, HYDRAULIC STRUCTURES. Do not apply paint until piping tests have been completed.
- f. Identification of Piping: Identify piping aboveground in accordance with MIL-STD-101, using adhesive-backed or snap-on plastic labels and

arrows. In lieu of labels, identification tags may be used. Apply labels or tags to finished paint at intervals of not more than 50 feet. Provide two copies of the piping identification code framed under glass and install where directed.

3.1.2.3 Buried Plastic Lines

Provide totally PE piping. Prior to installation, obtain printed instructions and technical assistance in proper installation techniques from pipe manufacturer. When joining new PE pipe to existing pipe line, ascertain what procedural changes in the fusion process is necessary to attain optimum bonding.

- a. PE Piping: Prior to installation, CONTRACTOR shall have supervising and installing personnel, certified in accordance with paragraph entitled "Welder's Qualifications." Provide fusion-welded joints except where transitions have been specified. Use electrically heated tools, thermostatically controlled and equipped with temperature indication. Where connection must be made to existing plastic pipe, CONTRACTOR shall be responsible for determination of compatibility of materials and procedural changes in fusion process necessary to attain maximum integrity of bond.
- b. Laying PE Pipe: Bury pipe 24 inches below finish grade or deeper when indicated. Lay in accordance with manufacturer's printed instructions.

3.1.2.4 Connections to Existing Pipeline

When making connections to live gas mains, use pressure tight installation equipment operated by workmen trained and experienced in making hot taps. For connections to existing underground pipeline or service branch, use transition fittings for dissimilar materials.

3.1.2.5 Wrapping

Where connection to existing steel line is made underground, tape wrap new steel transition fittings and exposed existing pipe having damaged coating. Clean pipe to bare metal. Initially stretch first layer of tape to conform to the surface while spirally half-lapping. Apply a second layer, half-lapped and spiraled as the first layer, but with spirals perpendicular to first wrapping. Use 0.025 mm 10 mil minimum thick polyethylene tape. In lieu of tape wrap, heat shrinkable 0.025 mm 10 mil minimum thick polyethylene sleeve may be used.

3.1.3 Valves

Install valves approximately at locations indicated. Orient stems vertically, with operators on top, or horizontally.

3.1.3.1 Pressure Regulator

Provide ball valve ahead of regulator. Install gas meter in conjunction with pressure regulator. On outlet side of regulator, provide a union and a 3/8 inch gage tap with plug.

3.1.3.2 Stop Valve and Shutoff Valve

Provide stop valve on service branch at connection to main and shut-off

valve on riser outside of building.

3.1.4 Pipe Sleeves

Where piping penetrates concrete or masonry wall, floor or firewall, provide pipe sleeve poured or grouted in place. Make sleeve of steel or cast-iron pipe of such size to provide 1/4 inch or more annular clearance around pipe. Extend sleeve through wall or slab and terminate flush with both surfaces. Pack annular space with oakum, and caulk at ends with silicone construction sealant.

3.1.5 Piping Hangers and Supports

Selection, fabrication, and installation of piping hangers and supports shall conform with MSS SP-69 and MSS SP-58, unless otherwise indicated.

3.1.6 Final Connections

Make final connections to equipment and appliances using rigid pipe and fittings, except for the following:

3.1.6.1 Domestic Water Heaters

Connect with AGA-Approved semi-rigid tubing and fittings.

3.2 FIELD QUALITY CONTROL

3.2.1 Metal Welding Inspection

Inspect for compliance with NFPA 54. Replace, repair, and then re-inspect defective welds.

3.2.2 PE Fusion Welding Inspection

Visually inspect butt joints by comparing with manufacturer's visual joint appearance chart. Inspect fusion joints for proper fused connection. Replace defective joints by cutting out defective joints or replacing fittings. Inspect 100 percent of all joints and reinspect all corrections. Arrange with the pipe manufacturer's representative in the presence of the ENGINEER to make first time inspection.

3.2.3 Pressure Tests

Use test pressure of 1 1/2 times maximum working pressure, but in no case less than 50 psig. Do not test until every joint has set and cooled at least 8 hours at temperatures above 50 degrees F. Conduct testing before backfilling; however, place sufficient backfill material between fittings to hold pipe in place during tests. Test system gas tight in accordance with NFPA 54. Use clean dry air or inert gas, such as nitrogen or carbon dioxide, for testing. Systems which may be contaminated by gas shall first be purged as specified. Make tests on entire system or on sections that can be isolated by valves. After pressurization, isolate entire piping system from sources of air during test period. Maintain test pressure for at least 8 hours between times of first and last reading of pressure and temperature. Take first reading at least one hour after test pressure has been applied. Do not take test readings during rapid weather changes. Provide temperature same as actual trench conditions. There shall be no reduction in the applied test pressure other than that due to a change in ambient temperature. Allow for ambient temperature change in accordance with the

relationship $PF + 14.7 = (P1 + 14.7) (T2 + 460) / T1 + 460$, in which "T" and "PF" represent Fahrenheit temperature and gage pressure, respectively, subscripts "1" and "2" denote initial and final readings, and "PF" is the calculated final pressure. If "PF" exceeds the measured final pressure (final gage reading) by 1/2 psi or more, isolate sections of the piping system, retest each section individually, and apply a solution of warm soapy water to joints of each section for which a reduction in pressure occurs after allowing for ambient temperature change. Repair leaking joints and repeat test until no reduction in pressure occurs. In performing tests, use a test gage calibrated in one psi increments and readable to 1/2 psi.

3.2.4 System Purging

After completing pressure tests, and before testing a gas contaminated line, purge line with nitrogen at junction with main line to remove all air and gas. Clear completed line by attaching a test pilot fixture at capped stub-in line at building location and let gas flow until test pilot ignites. Procedures shall conform to NFPA 54.

<p>-CAUTION-</p> <p>Failure to purge may result in explosion within line when air-to-gas is at correct mixture.</p>

-- End of Section --

DIVISION 35
WATERWAY AND MARINE CONSTRUCTION

SECTION 35 31 19.20
ARTICULATED CONCRETE BLOCK REVETMENT

INDEX

SECTION 35 31 19.20 ARTICULATED CONCRETE BLOCK REVETMENT

PART 1 GENERAL 2

1.1 SCOPE OF WORK 2

1.2 REFERENCES 2

1.3 MEASUREMENT AND PAYMENT 2

1.4 SUBMITTALS 2

1.5 DEFINITIONS 3

1.5.1 Articulated Concrete Block (ACB) Revetment System 3

1.5.2 Blocks 3

1.6 DELIVERY, STORAGE, AND HANDLING 3

1.6.1 Blocks 3

PART 2 PRODUCTS 3

2.1 ARTICULATED CONCRETE BLOCK 3

2.1.1 Matrix Assembly - Three Strand Fiber Rope Systems 4

2.1.2 Structural requirements 4

2.2 MAT TO MAT CONNECTIONS 5

2.3 GEOTEXTILE FABRIC 5

PART 3 EXECUTION 5

3.1 ARTICULATED MAT PLACEMENT 5

3.2 BLOCK INSTALLATION 5

3.2.1 Placement of Pre-Assembled Mattresses 5

3.3 INSTALLATION MONITORING 5

SECTION 35 31 19.20

ARTICULATED CONCRETE BLOCK REVETMENT

PART 1 GENERAL

1.1 SCOPE OF WORK

This work consists of furnishing all labor, equipment and materials necessary to manufacture and place Articulated Concrete Block (ACB) revetment system in accordance with these specifications and as shown on the plans. The terms removable revetment mat and revetment mat for scour protection shall all refer to the same item articulated concrete block (ACB) revetment system. The concrete mattress shall be placed as scour protection as shown on the plans. The concrete mattress shall not be anchored to the bottom but shall be connected together.

1.2 REFERENCES

The publications listed below form a part of this specification to the extent referenced. The publications are referred within the text by the basic designation only.

ASTM INTERNATIONAL (ASTM)

ASTM C 140 (2007a) Standard Test Methods for Sampling and Testing Concrete Masonry Units and Related Units

ASTM C 42/C 42M (2004) Standard Test Method for Obtaining and Testing Drilled Cores and Sawed Beams of Concrete

U.S. FEDERAL HIGHWAY ADMINISTRATION (FHWA)

FHWA RD-89-199 (1989) Hydraulic Stability of Articulated Concrete Block Revetment Systems During Overtopping Flow

1.3 MEASUREMENT AND PAYMENT

All costs associated with articulated concrete block revetment, and as may be denoted in the contract documents shall be included in the contract price for Bid Items "Articulated Concrete Block Revetment." ACB will be measured in place to the nearest square foot of protected area as delineated in the drawings for Base Bid and Alternate 1. Price and payment shall constitute full compensation for providing all labor, material, and equipment and performing all operations necessary for the complete and satisfactory installation of the ACB. No payment shall be made for ACB that is rejected or damaged due to CONTRACTOR fault or negligence.

1.4 SUBMITTALS

ENGINEER approval is required for submittals with an "E" designation. Submittals with no designation are considered for information only. The following shall be submitted:

SD-02 Shop Drawings

Block Installation; E

Franklin Canal Pump Station

Drawings showing details of the ACB Installation, including the block layout patterns in relation to the feature alignment, mattress junction details, and proposed installation methods.

SD-03 Product Data

Articulated Concrete Block; E

Descriptive technical data on the blocks, ropes and mat to mat connections. Include all material properties specified under paragraph PRODUCTS. Catalog cuts, technical data sheets, or test data shall be submitted showing that the products meet the specifications. The submittal shall also include a copy of any standard manufacturer's warranties for the products.

SD-04 Samples

Articulated Concrete Block; E

Two samples of the proposed block at the same time as the ACB Data submittal. The samples shall be typical of the size, texture, color, and finish.

1.5 DEFINITIONS

1.5.1 Articulated Concrete Block (ACB) Revetment System

A matrix of interconnected cast-on-rope closed cell concrete block units for scour protection. Units are connected by three strand fiber rope and typically include a geotextile underlayment for subsoil retention. The geotextile can be connected or be independent of the blocks.

1.5.2 Blocks

Articulated concrete block revetment units will be referred to as blocks.

1.6 DELIVERY, STORAGE, AND HANDLING

Check products upon delivery to assure that the proper material has been received and is undamaged.

1.6.1 Blocks

Provide closed cell blocks which are sound and free of defects that would interfere with proper placement or that would impair the strength or longevity of the installation. Discard blocks with the following defects:

- a. Broken appendages.
- b. Chips larger than 2 inches in any dimension.
- c. Cracks wider than 0.02 inches and longer than 33% of the nominal height.

Minor cracks, incidental to the usual method of manufacture, or chipping that results from customary methods of handling in shipping, delivery and placement will not be deemed grounds for rejection. Store blocks in a suitable location away from mud, paint, wet cement, and other contamination or disturbance.

PART 2 PRODUCTS

2.1 ARTICULATED CONCRETE BLOCK

Franklin Canal Pump Station

The CONTRACTOR shall provide product data for the articulated concrete block.

The ACB shall meet the following criteria:

TABLE 1. ACB Requirements

<u>Criteria</u>	<u>Required Value</u>	<u>Test Method</u>
Matrix Assembly: Interlocking Blocks / Rope System		
Thickness, minimum	9 inches	N/A
Net Weight/Area, minimum	65 psf	Note a.
Critical Shear Stress, minimum	3.5 psf	FHWA RD-89-199
Critical Velocity, minimum	15 ft/sec	FHWA RD-89-199
Curvature Radius, maximum	3 feet	Note b.
Surface Void Area Ratio	< 10%	Note c.
Block/Geotextile Interface		
Friction Angle	35 degrees	Note d.

a. Determine the weight of the mattress per unit area with the nominal joint spacing, in a non-submerged condition.

b. The curvature radius shall be indicative of the ability of the assembled mattress to conform to one dimensional subgrade curves without binding, such as for anchor trenches and swales. The curvature radius shall be demonstrated, if requested by the ENGINEER.

c. The surface void area ratio shall be determined at the visible surface of the closed cell blocks, with the joints spaced in a neutral position (50%), and shall be expressed as a percentage of the gross mat area.

d. The concrete surface shall be sufficiently rough to prevent sliding of the blocks on the geotextile. The interface friction must be matched with the selected block, and shall be included with the ACB Data submittal. The block/geotextile interface friction angle shall be demonstrated, if requested by ENGINEER. The CONTRACTOR shall supply two samples of the proposed block. The samples shall be typical of the size, texture, color and finish.

2.1.1 Matrix Assembly - Three Strand Fiber Rope Systems

The fiber rope shall connect each element to all adjacent elements. The rope on the mat perimeter elements shall form lifting loops on all four sides of the mat. The rope shall be an ultra-violet stabilized copolymer extruded three-strand fiber rope. Minimum tensile strength shall be 9,500 pounds. The rope shall have a good to excellent resistance to concentrated acids, alkalis and solvents. The rope shall be impervious to rot, mildew and degradation due to marine organisms. The rope material shall not be affected by continuous immersion in salt water. Articulated concrete block, ropes, and fittings shall be fabricated into mattresses at the manufacturer's plant. The nominal mattress dimension shall be eight (8) feet by twenty (20) feet.

2.1.2 Structural requirements

Articulated concrete block shall be wet cast using concrete as specified herein, or dry-cast by a vibratory block forming machine. The blocks shall be manufactured to the following requirements:

Franklin Canal Pump Station

- a. The minimum compressive strength shall be 4,000 psi. Compressive strength shall be determined by ASTM C 42/C 42M for wet cast blocks, or by ASTM C 140 for dry cast blocks.
- b. The maximum water absorption for dry cast units shall be 9 pcf for an average of 3 units, and 12 pcf for an individual unit. Water absorption shall be determined by ASTM C 140.

2.2 MAT TO MAT CONNECTIONS

Connections between adjacent mats shall be made of A316-grade stainless steel banding. A minimum of eight (8) connectors per set of mats shall be required and installed as shown on the Plans unless approved by the ENGINEER. Connectors shall be provided by the mat manufacturer.

2.3 GEOTEXTILE FABRIC

The closed cell concrete mats shall be placed on a geotextile fabric as shown on the plans and in accordance with 31 05 19.02 12 GEOTEXTILE SEPARATOR specification, unless otherwise directed by the ENGINEER.

PART 3 EXECUTION

3.1 ARTICULATED MAT PLACEMENT

Place articulated mats in locations depicted on the Contract Drawings. Extend

3.2 BLOCK INSTALLATION

All placement of blocks shall be in accordance with the manufacturer's recommendations and the CONTRACTOR's approved shop drawings.

3.2.1 Placement of Pre-Assembled Mattresses

The mattresses shall be placed directly into position, with a maximum space or gap between mattresses of 3 inches in excess of the nominal joint spacing of blocks within the mattress. Mattresses out of alignment shall be lifted and reset. Mattresses shall not be pushed or pulled laterally after they are in contact with the soil or geotextile. No overlapping of mats will be accepted and no blocks shall project vertically more than 1 inch beyond the adjacent blocks. The bottom surface shall be free from obstructions and shall be dressed to a smooth surface. Special attention is to be paid that mats are not overlapping at trash screen locations.

The concrete mattress shall not be anchored to the canal bottom. The concrete mattress shall be connected together every other rope loop with a u-type having equal or greater strength than the rope. The voids of the concrete mattress shall not be filled but shall be allowed to naturally silt in.

3.3 INSTALLATION MONITORING

CONTRACTOR shall monitor mattress installations for breakage, slippage and gaps, and shall reset mattresses as necessary to maintain complete coverage. Any loss of fill material due to movement or misplacement of ACB mattresses shall be replaced by CONTRACTOR at no direct pay.

-- End of Section --

DIVISION 40
PROCESS INTEGRATION

SECTION 40 05 13
DISCHARGE PIPING SYSTEM

INDEX

SECTION 40 05 13 - DISCHARGE PIPING SYSTEM

PART 1 GENERAL..... 2

1.1 SCOPE2

1.2 REFERENCES2

1.3 MEASUREMENT AND PAYMENT4

1.4 SUBMITTALS4

1.5 SYSTEM DESCRIPTION5

1.5.1 Performance Requirements5

1.6 QUALIFICATIONS5

1.6.1 CONTRACTOR5

1.6.2 Welders5

1.7 DELIVERY, STORAGE, AND HANDLING5

PART 2 PRODUCTS..... 6

2.1 MATERIALS AND EQUIPMENT6

2.1.1 Identification and Tagging6

2.1.2 Accessories.....6

2.1.2.1 Modular Seal and Sleeve6

2.2 CARBON STEEL PIPING SYSTEM6

2.2.1 Carbon Steel Pipe6

2.2.1.1 General Service6

2.2.2 Carbon Steel Joints6

2.2.3 Carbon Steel Fittings6

2.2.3.2 Welding Fittings7

2.2.3.3 Flanged Fittings7

2.2.4 Carbon Steel Coatings7

PART 3 EXECUTION..... 7

3.1 EXAMINATION7

3.2 PREPARATION7

3.2.1 Protection7

3.2.2 System Preparation7

3.2.2.1 Pipe and Fittings7

3.2.2.2 Field Fabrication7

3.3 PIPING INSTALLATION8

3.3.1 Couplings, Adapters and Service Saddles8

3.3.3 Pipe Flanges8

3.4 PAINTING8

3.5 FIELD QUALITY CONTROL8

3.5.1 Hydrostatic Testing8

3.5.1.1 Time for Making Test9

3.5.2 Pipe Leakage Tests9

3.6 FINAL CLEANING9

3.6.1 Interim Cleaning9

SECTION 40 05 13

DISCHARGE PIPING SYSTEM

PART 1 GENERAL

1.1 SCOPE

This section includes performance criteria, materials, design, production, and erection of discharge piping and all applicable connections to pile supports and floodwall, including saddles and link-seals, as shown on the Contract Drawings. The work performed under this Section includes all labor, material, equipment, related services, and supervision required for the manufacture and erection of the discharge piping work shown on the Contract Drawings.

1.2 REFERENCES

The publications listed below form a part of this specification to the extent referenced. The publications are referred to within the text by the basic designation only.

AMERICAN WATER WORKS ASSOCIATION (AWWA)

AWWA C500 (2002; R 2003) Metal-Seated Gate Valves for Water Supply Service

AWWA C504 (2006) Standard for Rubber-Seated Butterfly Valves

AMERICAN WELDING SOCIETY (AWS)

AWS D1.1/D1.1M (2008; Errata 2009) Structural Welding Code - Steel

ASME INTERNATIONAL (ASME)

ASME B1.20.1 (1983; R 2006) Pipe Threads, General Purpose (Inch)

ASME B16.1 (2005) Standard for Gray Iron Threaded Fittings; Classes 125 and 250

ASME B16.11 (2005) Forged Fittings, Socket-Welding and Threaded

ASME B16.21 (2005) Nonmetallic Flat Gaskets for Pipe Flanges

ASME B16.34 (2004) Valves - Flanged, Threaded and Welding End

ASME B16.9 (2007) Standard for Factory-Made Wrought Steel Buttwelding Fittings

ASME B31.1 (2007; Addenda 2008) Power Piping

Franklin Canal Pump Station

ASME B31.3	(2008) Process Piping
ASME B36.10M	(2004) Standard for Welded and Seamless Wrought Steel Pipe
ASME B40.100	(2005) Pressure Gauges and Gauge Attachments
ASTM INTERNATIONAL (ASTM)	
ASTM A 105/A 105M	(2005) Standard Specification for Carbon Steel Forgings for Piping Applications
ASTM A 126	(2004) Standard Specification for Gray Iron Castings for Valves, Flanges, and Pipe Fittings
ASTM A 153/A 153M	(2005) Standard Specification for Zinc Coating (Hot-Dip) on Iron and Steel Hardware
ASTM A 167	(1999; R 2004) Standard Specification for Stainless and Heat-Resisting Chromium-Nickel Steel Plate, Sheet, and Strip
ASTM A 193/A 193M	(2008b) Standard Specification for Alloy-Steel and Stainless Steel Bolting Materials for High-Temperature Service
ASTM A 194/A 194M	(2008b) Standard Specification for Carbon and Alloy Steel Nuts for Bolts for High-Pressure or High-Temperature Service, or Both
ASTM A 36/A 36M	(2008) Standard Specification for Carbon Structural Steel
ASTM A 47/A 47M	(1999; R 2004) Standard Specification for Steel Sheet, Aluminum-Coated, by the Hot-Dip Process
ASTM A 53/A 53M	(2007) Standard Specification for Pipe, Steel, Black and Hot-Dipped, Zinc-Coated, Welded and Seamless
ASTM A 536	(1984e1; R 2004) Standard Specification for Ductile Iron Castings
ASTM A 576	(1990b; R 2006) Standard Specification for Steel Bars, Carbon, Hot-Wrought, Special Quality
ASTM D 3308	(2006) PTFE Resin Skived Tape
MANUFACTURERS STANDARDIZATION SOCIETY OF THE VALVE AND FITTINGS INDUSTRY (MSS)	
MSS SP-25	(2008) Standard Marking System for Valves, Fittings, Flanges and Unions

Franklin Canal Pump Station

MSS SP-58 (2004) Standard for Pipe Hangers and Supports
- Materials, Design and Manufacture

NATIONAL FIRE PROTECTION ASSOCIATION (NFPA)

NFPA 704 (2006) Identification of the Hazards of
Materials for Emergency Response

U.S. NATIONAL ARCHIVES AND RECORDS ADMINISTRATION (NARA)

29 CFR 1910 Occupational Safety and Health Standards

1.3 MEASUREMENT AND PAYMENT

Discharge piping systems will be measured on a lump sum basis separately for each pump system as shown on the drawings for Base Bid, Alternate 2, and Alternate 3. Bid items include 42" discharge piping, saddles, HSS section pedestals (under deck locations only), floodwall penetrations, in-line backflow prevention, link seals, and connections as shown on contract drawings.

Payment for pipe supports on the flood side as shown on contract drawings for Base Bid will be made under Bid Item: "Discharge Pipe Supports, Flood Side," on a lump sum basis.

Payment for pipe supports on the protected side as shown on contract drawings for the Base Bid and Alternate 1 will be made under Bid Items: "Discharge Pipe Supports, Protected Side," per each.

Payment for pipe supports under the pump station deck as shown on contract drawings for the Base Bid and Alternate 1 will be made under Bid Items: "Discharge Pipe Supports, Under Deck," per each.

1.4 SUBMITTALS

ENGINEER approval is required for submittals with an "E" designation. Submittals with no designation are considered for information only. Submit the following:

SD-02 Shop Drawings

Materials and Equipment; E

Equipment shop drawings and support system detail drawings showing piping systems and appurtenances, such as mechanical joints. As-built drawings showing layout of piping systems relative to other parts of the work including clearances for maintenance and operation.

SD-03 Product Data

Qualifications

A statement certifying that the CONTRACTOR has the specified experience.

Franklin Canal Pump Station

Welders; E

The names of all qualified welders, their identifying symbols, and the qualifying procedures for each welder including support data such as test procedures used, standards tested to, etc.

Materials and Equipment; E

See 2.1.1 of Section 31 62 14; E.

Installation; E

SD-06 Test Reports

Weld Inspection Reports (2.2.1 of Section 31 62 14); E.

1.5 SYSTEM DESCRIPTION

This specification covers the requirements for discharge pipe, pipe supports, fittings, elastomeric material, equipment, valves and accessories located outside of the pump station.

1.5.1 Performance Requirements

The pressure ratings and materials specified represent minimum acceptable standards for piping systems. The piping systems shall be suitable for the services specified and intended. Each piping system shall be coordinated to function as a unit. Flanges, valves, fittings and appurtenances shall have a pressure rating no less than that required for the system in which they are installed.

1.6 QUALIFICATIONS

1.6.1 CONTRACTOR

CONTRACTOR shall have successfully completed at least 2 projects of the same scope and size or larger within the last 6 years. CONTRACTOR shall demonstrate specific experience in regard to the system installation to be performed.

1.6.2 Welders

The welding of piping systems shall be in accordance with qualifying procedures using performance qualified welders and operators. Procedures and welders shall be qualified in accordance with Section 05 12 00 STRUCTURAL STEEL. Structural members shall be welded in accordance with Section 05 12 00 STRUCTURAL STEEL.

1.7 DELIVERY, STORAGE, AND HANDLING

Materials delivered and placed in storage shall be stored with protection from the weather, excessive humidity variation, excessive temperature variation, dirt, dust and/or other contaminants. Proper protection and care of material before, during and after installation is the CONTRACTOR's responsibility. Any material found to be damaged shall be replaced at the

Franklin Canal Pump Station

CONTRACTOR's expense. During installation, piping shall be capped to keep out dirt and other foreign matter. Storage facilities shall be classified and marked in accordance with NFPA 704. Materials shall be stored with protection from puncture, dirt, grease, moisture, mechanical abrasions, excessive heat, ultraviolet (UV) radiation damage, or other damage. Pipe and fittings shall be handled and stored in accordance with the manufacturer's recommendation.

PART 2 PRODUCTS

2.1 MATERIALS AND EQUIPMENT

Provide piping materials and appurtenances as specified and as shown on the drawings, and suitable for the service intended. Piping materials, appurtenances, and equipment supplied as part of this contract shall be of equal material and ratings as the connecting pipe, new and unused except for testing equipment. Components that serve the same function and are the same size shall be identical products of the same manufacturer. The general materials to be used for the piping systems shall be either ASTM A 53/A 53M, Grade B, Type S, AWWA C200, or API-5L DSAW. Pipe fittings shall be compatible with the applicable pipe materials.

2.1.1 Identification and Tagging

Each piece of pipe shall bear the ASTM designation and all other markings required for that designation. The service, valve identification number shown on the Valve Schedule in the contract drawings, the manufacturer's name, and the valve model number shall be displayed.

2.1.2 Accessories

2.1.2.1 Modular Seal and Sleeve

Use a modular hole-forming system consisting of interlocking high density polyethylene (HDPE) plastic discs, domestically manufactured in an ISO-9001:2000 facility. The system shall provide a round hole in conformance with Link-Seal Modular Seal or approved equal.

2.2 CARBON STEEL PIPING SYSTEM

2.2.1 Carbon Steel Pipe

2.2.1.1 General Service

Carbon steel pipe shall meet the requirements of either ASTM A 53/A 53M seamless, Grade B, AWWA C200, or API-5L DSAW. Wall thickness shall be 0.375 inches in accordance with ASME B36.10M.

2.2.2 Carbon Steel Joints

Carbon steel piping shall be joined by welding fittings or flanges. Dielectric fittings or isolation joints shall be provided between all dissimilar metals.

2.2.3 Carbon Steel Fittings

Fittings shall be carbon steel to match the pipe.

2.2.3.2 Welding Fittings

Welding fittings shall be butt-welding or socket-welding. Welding fittings shall be forged steel, ASTM A 105/A 105M Class 150 conforming to ASME B16.9, or ASME B16.11.

2.2.3.3 Flanged Fittings

The internal diameter bores of flanges and flanged fittings shall be the same as that of the associated pipe. The flanges shall be welding neck or slip-on. Flanges and flanged fittings shall be forged steel, ASTM A 105/A 105M, faced and drilled to ASME B16.1 Class 150 with a 0.0625 inch raised face. Bolting shall be alloy-steel ASTM A 193/A 193M Grade B8 hex head bolts and ASTM A 194/A 194M Grade 8 hex head nuts. When mating flange on valves or equipment is cast iron, ASTM A 193/A 193M Grade B8 Class 1 bolts and ASTM A 194/A 194M Grade 8 heavy hex head nuts shall be used. Bolts shall be provided with washers of the same material as the bolts. Gaskets shall meet the requirements of ASME B16.1. Nonmetallic gaskets shall conform to ASME B16.21 and be a maximum 0.125 inch thick chloroprene rubber, durometer hardness No.80, 1,500 psi minimum tensile strength, 125 percent minimum elongation, flat ring type for use with raised face flanges and full face type for use with flat face flanges.

2.2.4 Carbon Steel Coatings

Carbon steel coating shall conform to Section 09 97 02 PAINTING: HYDRAULIC STRUCTURES.

PART 3 EXECUTION

3.1 EXAMINATION

After becoming familiar with all details of the work, verify all dimensions in the field, and advise the ENGINEER of any discrepancy before performing the work.

3.2 PREPARATION

3.2.1 Protection

Pipe and equipment openings shall be closed with caps or plugs during installation. Equipment shall be protected from dirt, water, and chemical or mechanical damage.

3.2.2 System Preparation

3.2.2.1 Pipe and Fittings

Pipe and fittings shall be inspected before exposed piping is installed. Clean the ends of pipes thoroughly, remove foreign matter and dirt from inside of pipes, and keep piping clean during and after laying.

3.2.2.2 Field Fabrication

Notify the ENGINEER at least 2 weeks prior to the field fabrication of pipe or fittings and at least 3 days prior to the start of any surface

preparation or coating application work. Field welding shall be performed in accordance with Section 05 12 00 STRUCTURAL STEEL. Welding electrodes shall be provided in accordance with Table 3.1 of AWS D1.1/D1.1M as required for the applicable base metals and welding process. Fabrication of fittings shall be performed in accordance with the manufacturer's instructions.

3.3 PIPING INSTALLATION

Piping shall be run as straight as practical along the alignment shown on the contract drawings and with a minimum of joints. Piping and appurtenances shall be installed in conformance with reviewed shop drawings, manufacturer's instructions and ASME B31.3. Piping shall be installed without springing or forcing the pipe. Welding shall be performed in accordance with 05 12 00 STRUCTURAL STEEL.

3.3.1 Couplings, Adapters and Service Saddles

Pipes shall be thoroughly cleaned of oil, scale, rust, and dirt in order to provide a clean seat for gaskets. Gaskets shall be wiped clean prior to installation. Flexible couplings and flanged coupling adapter gaskets shall be lubricated with soapy water or the manufacturer's standard lubricant before installation on the pipe ends. Couplings, service saddles, and anchor studs shall be installed in accordance with manufacturer's instructions. Bolts shall be tightened progressively, drawing up bolts on opposite sides a little at a time until all bolts have a uniform tightness. Torque-limiting wrenches shall be used to tighten bolts.

3.3.3 Pipe Flanges

Pipe flanges shall be set level, plumb, and aligned. Flanged fittings shall be installed true and perpendicular to the axis of the pipe. The bolt holes shall be concentric to the centerline of the pipe and shall straddle the vertical centerline of the pipe.

Pipe flange at pump shall match pipe flange provided by pump manufacturer at discharge level.

Pipe flange at check valve shall accommodate check valve bolt and flange configuration.

3.4 PAINTING

Painting shall be performed in accordance with Section 09 97 02 PAINTING: HYDRAULIC STRUCTURES.

3.5 FIELD QUALITY CONTROL

3.5.1 Hydrostatic Testing

Piping systems shall be tested under normal service conditions to demonstrate compliance. Water shall be used as the hydrostatic test fluid.

The hydrostatic test pressure shall be maintained continuously for 30 minutes minimum and for such additional time necessary to conduct examinations for leakage. All joints and connections shall be examined for leakage. The piping system, exclusive of localized instances at the pump or valve packing, shall show no visual evidence of leaking. Correct visible

Franklin Canal Pump Station

leakage and retest. Unless otherwise directed by the ENGINEER, the piping system shall be drained of water after leaks are repaired.

3.5.1.1 Time for Making Test

Tests shall be conducted after the piping has been completely installed, including all supports, and inspected for proper installation.

3.5.2 Pipe Leakage Tests

Should any test disclose leakage, the leaks shall be located and repaired until the leakage is within the specified allowance, without additional cost.

3.6 FINAL CLEANING

3.6.1 Interim Cleaning

Prevent the accumulation of weld rod, weld spatter, pipe cuttings and filings, gravel, cleaning rags, and other foreign material within piping sections during fabrication. The piping shall be examined to assure removal of these and other foreign objects prior to assembly and installation.

-- End of Section --

SECTION 40 05 14
IN-LINE BACKFLOW PREVENTION

INDEX

SECTION 40 05 14 - In-line Backflow Prevention

PART 1 GENERAL..... 2
1.1 SCOPE2
1.2 REFERENCES2
1.3 MEASUREMENT AND PAYMENT2
1.4 SUBMITTALS2
1.5 QUALIFICATIONS2
PART 2 PRODUCTS..... 2
2.1 MATERIALS AND EQUIPMENT2
2.1.1 Backflow Preventer Check Valves2
2.1.2 Function3
PART 3 EXECUTION..... 3
3.1 INSTALLATION3
3.2 MANUFACTURER’S CUSTOMER SERVICE3

Franklin Canal Pump Stations

PART 1 GENERAL

1.1 SCOPE

The work covered by this section of the specifications consists of detailed requirements for the design, fabrication, shop assembly, testing, delivery, and installation of the check valves to regulate exit flow from the discharge pipes.

1.2 REFERENCES

NOT USED

1.3 MEASUREMENT AND PAYMENT

No separate measurement will be made for the material and work covered under this section. Payment will be made under Bid Items: "Discharge Pipe System, Pump 1" and "Discharge Pipe System, Pump 2" for the Base Bid.

Payment will be made under Bid Item: "Discharge Pipe System, Pump 3" for Bid Alternate 2.

Payment will be made under Bid Item: "Discharge Pipe System, Pump 4" for Bid Alternate 3.

1.4 SUBMITTALS

Submit product literature that includes information on the performance and operation of the valve, materials of construction, dimensions and weights, elastomer characteristics, headloss, flow data and pressure ratings.

Upon request, provide shop drawings that clearly identify the valve materials of construction and dimensions.

Submit results of independent hydraulic testing.

1.5 QUALIFICATIONS

Supplier shall have at least ten (10) years experience in the design and manufacture of elastomeric check valves.

Manufacturer shall have conducted independent hydraulic testing to determine headloss, jet velocity and vertical opening height characteristics on 42" check valves. The testing must have been conducted for free discharge (discharge to atmosphere) and submerged conditions.

PART 2 PRODUCTS

2.1 MATERIALS AND EQUIPMENT

2.1.1 Backflow Preventer Check Valves

Check valves are to be all rubber and the flow operated check type with flange connection. The entire check valve shall be ply reinforced throughout the body, disc and bill, which is cured and vulcanized into a one-piece unibody construction. A separate valve body or pipe used as the housing is not acceptable. The valve shall be manufactured with no metal, mechanical

Franklin Canal Pump Stations

hinges or fasteners, which would be used to secure the disc or bill to the valve housing. The port area of the disc shall contour down, which shall allow passage of flow in one direction while preventing reverse flow. The entire valve shall fit within the pipe I.D. Once installed, the check valve shall not protrude beyond the face of the structure or end of the pipe, as indicated in plans.

The downstream end of the valve must be circumferentially in contact with the pipe while in the closed positions.

Slip-in style check valves will be furnished with a set of stainless steel expansion clamps. The clamps, which will secure the valve in place, shall be installed inside the cuff portion of the valve, based on installation orientation, and shall expand outwards by means of a turnbuckle. Each clamp shall be predrilled allowing for the valve to be pinned and secured into position in accordance with the manufacturer's installation instructions. Flange style check valves will be furnished with a stainless steel, ANSI 125/150 drilled, retaining ring unless specified otherwise.

2.1.2 Function

When line pressure exceeds the backpressure, the line pressure forces the bill and disc of the valve open, allowing flow to pass. When the backpressure exceeds the line pressure, the bill and disc of the valve is forced closed, preventing backflow.

PART 3 EXECUTION

3.1 INSTALLATION

Valve shall be installed in accordance with manufacturer's written Installation and Operation Manual and approved submittals.

3.2 MANUFACTURER'S CUSTOMER SERVICE

The manufacturer shall also make customer service available directly from the factory in addition to authorized representatives for assistance during installation and start-up, and to train personnel in the operation, maintenance and troubleshooting of the valve.

-- End of Section --

DIVISION 43
PROCESS GAS AND LIQUID HANDLING

SECTION 43 21 40
PUMPS – WATER, VERTICAL AXIAL FLOW

INDEX

SECTION 43 21 40 - Pumps: Water, Vertical Axial Flow

PART 1 GENERAL3
1.1 SCOPE3
1.2 REFERENCES3
1.3 MEASUREMENT AND PAYMENT7
 1.3.1 Pump System - Vertical Axial Flow Pumps7
 1.3.1.1 Measurement7
 1.3.1.2 Payment7
 1.3.2 Erection Engineer7
 1.3.2.1 Services7
 1.3.2.1.1 Measurement7
 1.3.2.1.2 Payment7
1.4 SUBMITTALS7
1.5 SYSTEM DISCRIPTION9
1.6 QUALITY ASSURANCE9
 1.6.1 Detail Drawings.....10
1.7 DELIVERY, STORAGE AND HANDLING10
 1.7.1 General.....10
 1.7.2 Processing for Storage.....10
PART 2 PRODUCTS.....10
2.1 VERTICAL AXIAL FLOW WATER PUMPS11
 2.1.1 Pump Type11
 2.1.2 Pump Characteristics11
 2.1.3 Bowl Assembly11
 2.1.4 Pump Discharge Assembly11
 2.1.5 Cathodic Protection12
 2.1.6 Pump Mounting12
 2.1.7 Vibration Monitor12
2.2 PROPELLER PUMP GEAR REDUCER12
2.3 NATURAL GAS ENGINE14
 2.3.1 Engine type:14
 2.3.2 Engine Characteristics14
 2.3.3 Lubrication14
 2.3.4 Cooling System14
 2.3.4.1 Radiator.....15
 2.3.4.2 Louvers and Ductwork15
 2.3.5 Exhaust System15
 2.3.5.1 Exhaust Muffler.....16
 2.3.5.2 Flexible Sections and Expansion Joints16
 2.3.5.3 Emissions.....16
 2.3.6 Starting System16
 2.3.6.1 Electrical Starting System.....16
 2.3.7 Battery.....16
 2.3.8 Battery Charger.....17
 2.3.9 Governor17
 2.3.10 Safety Controls17
 2.3.11 Instrument Panel17

Franklin Canal Pump Station

- 2.4 FLEXIBLE UNIVERSAL SHAFT18
 - 2.4.1 General18
 - 2.4.2 Drive Shaft Assembly Construction18
- 2.5 EQUIPMENT APPURTENANCES19
 - 2.5.1 Attachments19
 - 2.5.2 Equipment Guards19
 - 2.5.3 Tools19
 - 2.5.4 Painting20
 - 2.5.5 Float Switch20
 - 2.5.6 Vibration Monitor20
- 2.6 DATA PLATES20
- PART 3 EXECUTION.....20
 - 3.1 PUMP CONSTRUCTION20
 - 3.1.1 Analysis.....20
 - 3.1.2. Vibration22
 - 3.2 INSTALLATION22
 - 3.2.1 System Coordination.....23
 - 3.2.2 Operating Instructions.....23
 - 3.3 FIELD TESTS23
 - 3.3.1 Procedures.....23
 - 3.3.2 Reporting.....23
 - 3.4 FIELD PAINTING24
 - 3.4.1 Touch-Up Painting.....24
 - 3.4.2 Exposed Ferrous Surfaces.....24
 - 3.5 CLOSEOUT ACTIVITIES24
 - 3.5.1 Training.....24
 - 3.5.2 Operation and Maintenance Manuals.....24
 - 3.5.3 Special Warranty Period25

SECTION 43 21 40

PUMP SYSTEM - WATER, VERTICAL AXIAL FLOW

PART 1 GENERAL

1.1 SCOPE

The work specified in this section consists of the furnishing of all equipment, materials and labor for providing and installing the pump system package. Pump system package is to include a vertical axial flow water pump, a propeller pump gear reducer, a lube-oil system, a natural gas engine, a cooling system, a radiator, an exhaust system, a starting system, a governor, and all additional required equipment, machinery, hangars, and supports for a fully operational and serviceable pump system.

1.2 REFERENCES

The publications listed below form a part of this specification to the extent referenced. The publications are referred to within the text by the basic designation only.

ACOUSTICAL SOCIETY OF AMERICA (ASA)

ASA S2.19 (1999; R 2004) Mechanical Vibration - Balance Quality Requirements of Rigid Rotors, Part 1: Determination of Permissible Residual Unbalance, Including Marine Applications

AMERICAN NATIONAL STANDARDS INSTITUTE (ANSI)

ANSI C39.1 (1981; R 1992) Requirements for Electrical Analog Indicating Instruments

AMERICAN PETROLEUM INSTITUTE (API)

API RP 686 (2009) Recommended Practice for Machinery Installation and Installation Design

AMERICAN WATER WORKS ASSOCIATION (AWWA)

AWWA C200 (2012) Steel Water Pipe - 6 In. (150 mm) and Larger

AWWA C203 (2008) Coal-Tar Protective Coatings

and Linings for Steel Water Pipelines
- Enamel and Tape - Hot-Applied

AWWA C207 (2007) Standard for Steel Pipe Flanges
for Waterworks Service-Sizes 100 mm
through 3600 mm 4 in. through 144 in.

AWWA C208 (2012) Standard for Dimensions for
Fabricated Steel Water Pipe Fittings

AMERICAN WELDING SOCIETY (AWS)

AWS D1.1/D1.1M (2012; Errata 2011) Structural Welding
Code -
Steel

ASME INTERNATIONAL (ASME)

ASME B16.5 (2009) Pipe Flanges and Flanged
Fittings: NPS 1/2 Through NPS 24
Metric/Inch Standard

ASME B46.1 (2009) Surface Texture, Surface
Roughness, Waviness and Lay

ASTM INTERNATIONAL (ASTM)

ASTM A106/A106M (2011) Standard Specification for
Seamless Carbon Steel Pipe for High-
Temperature Service

ASTM A181/A181M (2012) Standard Specification for
Carbon Steel Forgings, for General-
Purpose Piping

ASTM A108 (2007) Standard Specification for
Steel Bar, Carbon and Alloy, Cold-
Finished

ASTM A217/A217M (2011) Standard Specification for
Steel Castings, Martensitic Stainless
and Alloy, for Pressure-Containing
Parts, Suitable for High-Temperature
Service

ASTM A234/A234M (2011a) Standard Specification for
Piping Fittings of Wrought Carbon
Steel and Alloy Steel for Moderate
and High Temperature Service

Franklin Canal Pump Station

ASTM A27/A27M	(2010) Standard Specification for Steel Castings, Carbon, for General Application
ASTM A285/A285M	(2012) Standard Specification for Pressure Vessel Plates, Carbon Steel, Low- and Intermediate-Tensile Strength
ASTM A351/A351M	(2012a) Standard Specification for Castings, Austenitic, for Pressure-Containing Parts
ASTM A352/A352M	(2006; R 2012) Standard Specification for Steel Castings, Ferritic and Martensitic, for Pressure-Containing Parts, Suitable for Low-Temperature Service
ASTM A36/A36M	(2008) Standard Specification for Carbon Structural Steel
ASTM A48/A48M	(2003; R 2008) Standard Specification for Gray Iron Castings
ASTM A516/A516M	(2010) Standard Specification for Pressure Vessel Plates, Carbon Steel, for Moderate- and Lower-Temperature Service
ASTM A576	(1990b; R 2012) Standard Specification for Steel Bars, Carbon, Hot-Wrought, Special Quality
ASTM A609/A609M	(2012) Standard Specification for Castings, Carbon, Low-Alloy, and Martensitic Stainless Steel, Ultrasonic Examination Thereof
ASTM A668/A668M	(2004; R 2009) Standard Specification for Steel Forgings, Carbon and Alloy, for General Industrial Use
ASTM B148	(1997; R 2009) Standard Specification for Aluminum-Bronze Sand Castings
ASTM B584	(2012a) Standard Specification for Copper Alloy Sand Castings for General Applications

Franklin Canal Pump Station

ASTM D2000	(2012) Standard Classification System for Rubber Products in Automotive Applications
ASTM E165/E165M	(2012) Standard Practice for Liquid Penetrant Examination for General Industry
ASTM E709	2008) Standard Guide for Magnetic Particle Examination
ASTM F1476	(2007) Standard Specification for Performance of Gasketed Mechanical Couplings for Use in Piping Applications
ASTM A53/A53M	(2012) Standard Specification for Pipe, Steel, Black and Hot-Dipped, Zinc-Coated, Welded and Seamless
ASTM B395/B395M	(2008) Standard Specification for U-Bend Seamless Copper and Copper Alloy Heat Exchanger and Condenser Tubes
ASTM C1045 PSQ	(2007) Standard Practice for Calculating Thermal Transmission Properties Under Steady-State Conditions
ASTM C533	(2011) Standard Specification for Calcium Silicate Block and Pipe Thermal Insulation

HYDRAULIC INSTITUTE (HI)

HI 2.4	(2008) Rotodynamic (Vertical) Operations
HI 2.6	(2000) Vertical Pump Tests
HI 9.1-9.5	(2000) Pumps - General Guidelines for Types, Applications, Definitions, Sound Measurements and Documentation

NATIONAL FIRE PROTECTION ASSOCIATION (NFPA)

Franklin Canal Pump Station

NFPA 30 (2012) Flammable and Combustible Liquids Code

NFPA 37 (2010) Standard for the Installation and Use of Stationary Combustion Engines and Gas Turbines

UNDERWRITERS LABORATORIES (UL)

UL 1236 (2006; Reprint Jul 2011) Standard for Battery Chargers for Charging Engine-Starter Batteries

1.3 MEASUREMENT AND PAYMENT

1.3.1 Pump System - Vertical Axial Flow Pumps

1.3.1.1 Measurement

Unit of measure: each

1.3.1.2 Payment

Payment will be made for costs associated with furnishing and installing the vertical axial-flow pumps, propeller pump gear reducer, natural gas engine, lube-oil system, cooling system, radiator, exhaust system, starting system, governor, and all additional required equipment, machinery, hangars, and supports for a fully operational and serviceable pump system for Base Bid, Alternate 2, and Alternate 3 as specified under Bid Items "Pump System."

If Alternate 2 or 3 is chosen, additional piping for gas supply shall be included in Bid Items "Pump System No. 3" and "Pump System No. 4."

1.3.2 Erection Engineer

1.3.2.1 Services

1.3.2.1.1 Measurement

All costs associated with providing the services of erection engineer(s) will be included in the lump sum price for each pump package.

1.3.2.1.2 Payment

Payment will be made for all costs associated with the services of erection engineer(s) within the Bid Items "Pump System".

1.4 SUBMITTALS

Franklin Canal Pump Station

ENGINEER approval is required for submittals with a "E" designation; submittals not having a "E" designation are for information only.

SD-01 Preconstruction Submittals

Installation Procedures - Installation sequence drawings, equipment delivery, delivery unloading and installation instructions - Pump System; E

SD-02 Shop Drawings

Detail Drawings - Pump Equipment; E

Detail Drawings - Pump Gear Reducer; E

Detail Drawings - Engine, drive shaft assembly, exhaust and cooling systems, including supports, connections and openings to concrete platform and metal building; E

SD-03 Product Data

Pump Package - number, type and size of pump; E

Complete Parts List - for entire pump system; E

Drive Shaft Assembly; E

Float Switch; E

Vibration Monitor Switch; E

Total Head; E

Installation and Erection Instructions Manual; E

Field Tests; E

Balance Tests; E

SD-04 Samples

Materials; E

SD-05 Design Data

Dynamic Analysis; E

Franklin Canal Pump Station

SD-06 Test Reports

Pump model test performance for each size pump; E

Witness Test; E

Factory Test; E

Engine Test; E

A fully documented shop test report

SD-7 Certificates

Regulatory Requirements; E

SD-11 Closeout Submittals

Operation, Control and Maintenance Instructions Manuals:

Pump Equipment; E

Speed Reducer Gear; E

Engine Equipment; E

1.5 SYSTEM DISCRIPTION

Design, furnish, and install vertical axial flow propeller type pumps, single stage, capable of pumping the water in addition to a propeller pump gear reducer, natural gas engine, a lube-oil system, a cooling system, a radiator, an exhaust system, a starting system, a governor, and all additional required equipment, machinery, bearing lubrication system, hangars and supports for a fully operational and serviceable pump system and as included in this specification.

1.6 QUALITY ASSURANCE

Furnish one or more competent erecting ENGINEERs fluent in English language who is knowledgeable about the installation of the vertical pumps and associated drive machinery. Erecting ENGINEERs provided by this section shall include those from CONTRACTOR's suppliers. When so requested, erecting ENGINEERs shall provide and be responsible for providing complete and correct direction during initial starting and subsequent operation of equipment until field tests are completed. Erecting ENGINEER shall initiate instructions for actions necessary for proper receipt, inspection, handling, uncrating, assembly, and testing of equipment. The Erecting ENGINEER(s) shall also keep a record of measurements taken during erection, and shall furnish one copy to ENGINEER on request or on completion of installation of assembly or part. Erecting ENGINEER shall instruct ENGINEER in

Franklin Canal Pump Station

operation and maintenance features of work.

1.6.1 Detail Drawings

Submit drawings of sufficient size to be easily read, within 90 days of notice of award of contract. Outline drawings of pump system showing pertinent dimensions and weight of each component of the system. Drawing showing details and dimensions of pump system mounting design or layout including any embedded items. Cross-sectional drawings of pump system showing each component. Show major sections of pump system in detail. Indicate on each drawing an itemized list of components showing type, grade, and class of material used and make and model number of standard component used. Detail and assembly drawings required for manufacturing showing dimensions, tolerances, and clearances of shafts, bearings, including dimensions of grooving, couplings, and packing gland, and diameter and tip clearance of propeller. Drawings covering erection and installation, which CONTRACTOR intends to furnish to erecting ENGINEER.

1.7 DELIVERY, STORAGE AND HANDLING

1.7.1 General

Furnish major pump system components with lifting lugs or eye bolts to facilitate handling. Design and arrange lugs or bolts to allow safe handling of pump system components singly or collectively as required during shipping, installation, and maintenance.

1.7.2 Processing for Storage

Prepare pump system (and spare parts) for storage indoors. Indoor storage consists of a permanent building that has leak-proof roof, full walls to contain stored equipment, and a concrete floor or temporary trailers. A temporary structure may also be built at job site for equipment storage that will contain features of the permanent building above except that provision for ventilation will be provided and floor may be crushed rock. A vapor barrier will be provided below the crushed rock. Crushed rock will be of sufficient thickness so that settlement of equipment will not occur. Equipment stored on crushed rock will have cribbing under each support location so that equipment does not come in contact with crushed rock. A plastic barrier will be placed between equipment and wood cribbing. Submit a list of equipment and materials requiring humidity-controlled storage to ENGINEER no later than 30 days prior to shipment of pumping units. Long term storage (greater than 6 months) requirements shall be in accordance with pump manufacturer's recommendations.

PART 2 PRODUCTS

Franklin Canal Pump Station

2.1 VERTICAL AXIAL FLOW WATER PUMPS

2.1.1 Pump Type

Pumps shall be vertical axial flow type.

2.1.2 Pump Characteristics

The pump shall conform to the following mechanical and hydraulic characteristics:

Maximum pump rated speed	510
Rated capacity	50,000 gpm
Rated total head *	12.0 ft
Minimum bowl efficiency at rated condition	80%
Secondary condition capacity	40,000 gpm
Secondary condition total head	20.00 ft
Secondary condition bowl efficiency	80%
Column and discharge diameter	42 in

* Pump manufacturer to compute and add pump internal friction loss to develop Total Dynamic Head Bowl.

2.1.3 Bowl Assembly

The suction and discharge bowls shall be made of cast iron with a minimum tensile strength of 30,000 PSI. There shall be no fabricated impellers and bowl components. The suction bowl shall have a flared inlet with guide vanes to reduce inlet velocity, vortex and turbulence. The bowl shaft shall be made from type 416 stainless steel and polished at each bearing journal. The size of the shaft shall be sufficient to safely transmit the required brake horsepower to the propeller to produce the specified performance. Bronze bushings shall be provided immediately above and below the propeller. The impeller shall be made of cast Alloy 903 lead free bronze and secured to the shaft by a key and thrust collars. The propeller shall be statically and dynamically balanced such that undue vibration or other unsatisfactory characteristics will not result when the pump is in operation.

2.1.4 Pump Discharge Assembly

The pump column and discharge elbow shall be of fabricated steel conforming to ASTM A36 with a minimum wall thickness 3/8" inch. The column and elbow joints shall be flanged with register fits.

The discharge elbow shall be the mitered type with discharge orientation as shown on the plans. The discharge elbow shall be plain

end type suitable for use with a flexible pipe coupling. It shall incorporate 2 thrust lugs.

The lineshaft shall be made from carbon steel conforming to ASTM C1045 PSQ and supported by bearings. The lineshaft bearings shall be threaded externally to act as a coupling for extra heavy steel enclosing tubes. The lineshaft bearings shall be bronze of the removable type and provided with a means of passing oil lubricant from one bearing to the next. A means shall be provided for tension loading of the enclosing tube. Lineshaft and bearing assembly shall be submitted to ENGINEER prior to construction.

The discharge bowl bushings and lineshaft bearings shall be lubricated by a drip feed oil system consisting of a one-gallon oil reservoir, 24 volt solenoid valve and a needle valve dripper. The suction bowl bushing shall be grease packed.

2.1.5 Cathodic Protection

The submerged portions of the pump intake shall be supplied with passive cathodic protection using sacrificial anodes welded to the pump suction bell as detailed by the pump manufacturer. Number and arrangement of anodes shall be determined based on a minimum of 10 years of protection.

2.1.6 Pump Mounting

The pump shall be supplied with a sub-base plate (cast iron not acceptable) which shall be leveled and grouted in place to which the pump discharge head shall be bolted. This mounting plate facilitates removal and reinstallation of pumps without re-leveling and grouting. CONTRACTOR shall coordinate platform deck opening, plate size and anchorage with concrete prefabricator and pump supplier. Plate and anchorage shall be included in Bid Item "Pump System".

2.1.7 Vibration Monitor

Vibration monitors shall be provided for automatic shutdown of pump with excessive vibration.

2.2 PROPELLER PUMP GEAR REDUCER

The gear reducer shall be a De'Ran Gear Model M20A or approved equal. The gear reducer shall have a ratio of 7:2. The gear reducer should have a sprag type non-reverse mounted on the horizontal input shaft to stop the pump from reverse rotation.

The gear reducer shall be a single reduction spiral/bevel gear, right angle drive, with horizontal input shaft, and vertical downward output

Franklin Canal Pump Station

shaft. The gear reducer output shaft shall be coupled to the vertical shafting, and shall support the full weight of the vertical shafting. Gear reducer efficiency shall be not less than 97%. The gear reducer shall be designed and manufactured in accordance with AGMA Standards.

The casing shall be high tensile strength (minimum 30,000 PSI) cast iron or fabricated steel of adequate strength and rigidity to withstand all loads imposed on it from operation of the equipment, to maintain all gears, bearings, and seals in precise alignment. Lifting lugs shall be provided on the housing suitably located to enable safe removal of the gear reducer. The housing shall be equipped with tapping for oil fill, drain, level indication, breather, etc. and inspection covers as required, which shall be arranged and located for easy observation and access.

Gears shall be precision cut from alloy steel. All gears shall be manufactured spiral bevel to AGMA Quality 9 or better as outlined in AGMA Standards. Gear teeth shall be carburized and hardened to 58 to 60 Rockwell C and shall be lapped after teeth is permissible. Final surface finish of the gear teeth shall be 32 micro-inch or better. Calculations for strength and durability of gearing shall be based upon AGMA Standards. Ratings shall allow for a minimum of 200 percent momentary starting torque, and shall have a minimum of 1.5 service factor above the nameplate horsepower.

All bearings incorporated within the gear reducer shall be of the anti-friction type with an Anti-Friction Bearing Manufacturer's Association minimum rated life expectancy (B-10) of 25,000 hours when operating continuously at the full rated gear reducer output brake horsepower. All bearings shall be of standard design, readily available. Bearings shall be oversized to assure the exact position of gears and shafts are maintained. The output shaft bearings shall be oversized steep angled tapered roller bearings, designed to support the weight, and all operating loads of the vertical shafting to be connected to the pump.

All shafts shall be of SAE 4130 steel, designed to AGMA limits for shaft stress and to minimize deflection, with close finished tolerances by grinding.

Lubrication shall be by oil pressure lubrication of gears and bearings. All shafts shall have double lip oil seals, and the housing construction at the output shaft shall be dry well type to prevent oil from leaking down the output shaft. A positive displacement oil pump shall be provided integral to the gear reducer housing to provide oil circulation, and shall be driven from the gear reducer output shaft. The oil shall be circulated by the internal gear pump through a vertically mounted heat exchanger designed to dissipate heat from the reducer. The heat exchanger shall be designed to dissipate heat during

Franklin Canal Pump Station

full load pump operation in a 40° C ambient temperature. The heat exchanger shall be equipped with a fan which turns constantly with the vertical shaft. The fan shall be enclosed to protect from heat and moving parts, and shall be reservoir of the gear reducer to signal for shut-down if the oil temperature exceeds a preset limit. The switch shall be automatic trip on rising temperature, manual reset.

2.3 NATURAL GAS ENGINE

2.3.1 Engine type:

Engines shall be GE Gas engine, Model F18G or approved equal.

2.3.2 Engine Characteristics

Natural gas engine shall be heavy-duty, 4-cycle, water cooled, spark ignition engine. Engine shall be provided with a manual clutch and arranged for connection to the pump through a flexible shaft (drive shaft) with a splined joint. Engines shall be current models of type in regular production and shall be complete with all devices specified and normally furnished with the engine. Engine shall have a published continuous rating at least 20 percent greater than that required at any point on the pump performance curve at the specified pump speed plus power required for any engine driven accessories. Engine rating shall be decreased 1 percent for every 10 degrees F that the engine performance conditions exceed the published rating conditions. Engine shall be suitable for performance at 0-110 degrees F ambient and 20 feet elevation. Engine speed shall not exceed 1,800 rpm when driving the pump at rated conditions. Engine shall be capable of starting and assuming full load within 10 to 15 seconds, with a minimum ambient temperature of 0 degrees F. Approved engine jacket water heaters shall be provided as recommended by the manufacturer.

2.3.3 Lubrication

Each engine shall have a separate lube-oil system conforming to NFPA 30 and NFPA 37. Utilize a 24 volt Solenoid oiler, automatic drip feeder with sight glass, manual bypass, and oil reservoir. Full flow type filters with automatic bypass or bypass type filters shall be provided. Filter elements shall be of replaceable type and shall be readily accessible.

2.3.4 Cooling System

Each engine shall have its own cooling system. The system shall be of the closed type and operate automatically while the engine is running.

The cooling system shall have an engine-driven water pump, fin-tube radiator, and an automatic temperature regulating valve.

Franklin Canal Pump Station

The engine cooling system shall be of the closed type arranged to prevent rust and minimize formation of scale deposits within the engine. The system shall circulate jacket-coolant through the engine at the temperature and flow rate recommended by the engine manufacturer. The coolant shall be an ethylene-glycol water mixture with a concentration sufficient for freeze protection at the minimum outdoor temperature specified.

2.3.4.1 Radiator

Each radiator shall be sized to limit the maximum allowable temperature rise on the coolant across the engine to that recommended and submitted in paragraph SUBMITTALS, for the maximum outdoor design temperature and site elevation. Radiator fabrication materials shall be corrosion resistant and suitable for service in the ambient application conditions. The radiator may be factory coated with corrosive resistant film provided that corrective measures are taken to restore the heat rejection capability of the radiator to the initial design requirement via over-sizing or other compensating methods. Internal surfaces shall be compatible with liquid fluid coolant used. Materials and coolant are subject to approval by the ENGINEER. Radiators shall be the pressure type incorporating a pressure valve, vacuum valve, and a radiator cap. Radiator caps shall provide for pressure relief prior to removal. Each radiator shall be protected with a strong grille or screen guard. Radiators shall have at least two tapped holes. One tapped hole in the radiator shall be equipped with a drain cock; the rest shall be plugged.

2.3.4.2 Louvers and Ductwork

The louvers should be sized to provide adequate cooling of the pump system. Louver opening size shall be coordinated with building manufacturer to ensure opening is adequately supported by the building and is in compliance with all applicable codes.

Ductwork shall be completed in accordance with Section 23 31 13.00 40 DUCTWORK.

2.3.5 Exhaust System

The system shall be separate and complete for each engine. Exhaust piping shall be supported to minimize vibration. Provisions shall be made for pipe thermal expansion. Where a V-type engine having more than one exhaust outlet is provided, a V-type connector, with necessary flexible sections and hardware, shall connect the engine exhaust outlets. The exhaust connectors shall incorporate engine-mating and silencer-mating flanges, eliminating the need for adapters. Hangars, connections and openings to the metal building shall be provided with the exhaust system. Exhaust system shall be wrapped with

Franklin Canal Pump Station

fully faced and fitted insulation. Coordinate exit opening in building with building manufacturer; building manufacturer to provide boot or otherwise secure exit pipe opening from weather.

2.3.5.1 Exhaust Muffler

A chamber type exhaust muffler shall be provided. The muffler shall be fabricated of welded steel and designed for inside mounting. Eyebolts, lugs, flanges, or other items shall be provided as necessary for support of the muffler in the location and position indicated on the plans. The pressure drop through the muffler shall not exceed the recommendations of the engine manufacturer. The entire exhaust system shall be sized appropriately so that the operation of the engine is not affected by the exhaust system.

2.3.5.2 Flexible Sections and Expansion Joints

A flexible section shall be provided at each engine and an expansion joint at each muffler. Flexible sections and expansion joints shall have flanged connections. Elements in the flexible sections shall be capable of absorbing vibration as specified by pump system manufacturer.

2.3.5.3 Emissions

The finished installation shall comply with Federal and local regulations and restrictions regarding the limits of emissions such as carbon monoxide (CO), hydrocarbon (HC), and nitros (NOx).

2.3.6 Starting System

Each natural gas engine shall be provided with a starting system. The system shall be electric. The system shall have a start-stop switch which provides functions including testing, reset, manual run/start, manual stop. The starting system shall be the pump system manufacturer's standard equipment.

2.3.6.1 Electrical Starting System

An electrical starting system shall be provided to operate on a 24-V DC utilizing a negative circuit ground. An adjustable cranking device should be included to limit the engine cranking to a specified time limit. Starting motors shall be in accordance with SAE ARP892.

2.3.7 Battery

A starting battery system shall be provided and include the battery, battery rack, intercell connectors, spacers, automatic battery charger

Franklin Canal Pump Station

with overcurrent protection, metering, and relaying. The battery shall be in accordance with SAE J537. The battery shall have sufficient capacity, at the minimum ambient temperature specified, to provide a minimum cranking cycle consisting of three cranking periods of up to 8 sec per period with 8-sec intervals between crank periods.

2.3.8 Battery Charger

A current-limiting battery charger, conforming to UL 1236, shall be provided to automatically recharge the batteries. The charger shall be capable of providing both automatic float charging and equalizing charging of the battery installation. The charger shall be capable of recharging fully depleted batteries within 8 hours and providing a floating charge rate for maintaining the batteries in a fully charged condition. An ammeter and voltmeter shall be provided on the charger to indicate charging rate and voltage. The charger shall have alarm functions providing indications of low battery voltage, high battery voltage, and battery charger malfunction.

2.3.9 Governor

Each engine shall be provided with a governor to control the rotational speed of the engine in response to changing load requirements. The governor shall be configured for safe manual adjustment of the speed during operation of the engine, without special tools.

2.3.10 Safety Controls

Each engine shall be equipped with automatic shutdown features to stop the engine for high jacket water temperature, low oil pressure, and engine overspeed, and vibration. Shutdown features shall be connected to the annunciator on the instrument panel and each shutdown feature will be identified.

2.3.11 Instrument Panel

Each engine shall be furnished with an instrument panel mounted with vibration isolators on the unit. Instruments shall be of the direct reading type and shall be factory mounted and connected. Panel shall include the following features and instruments:

- a. Two-position MANUAL-OFF switch.
- b. Manual starting switch.
- c. Water temperature gauge.
- d. Ammeter-charging circuit.
- e. Tachometer.
- f. Lubricating oil pressure gauge.
- g. Individual indicating lights for low-oil pressure, high-

Franklin Canal Pump Station

water temperature, engine overspeed, and failure of engine to start.

- h. Manual engine speed regulating device.

2.4 FLEXIBLE UNIVERSAL SHAFT

2.4.1 General

A composite torque tube/universal joint drive shaft assembly as manufactured by Addax, Inc. of Lincoln, Nebraska, or approved equal shall be furnished and installed. The drive shaft shall be rated for the maximum operating power to the engines to be supplied and a normal operating speed of 1750 rpm.

The composite torque tube/universal joint drive shaft assembly will be designed and constructed to avoid harmonic vibrations throughout the operating speed range of the driven equipment. Lateral and torsional critical analysis will be conducted to demonstrate compliance with this requirement. Rotating equipment manufacturers of prime movers and pumps will furnish moment of inertia data, shaft torsional stiffness and number of impeller vanes to the drive shaft manufacturer for use in these analyses.

The drive shaft assembly shall be sized to operate below its critical speed at all times. The drive shaft critical speed shall be a minimum of 1.30 times the maximum operating speed. The drive shaft lateral critical and torsional natural frequencies shall be at least 1.20 times away from the vane pass frequency and any other excitation frequencies, including the half critical speed (universal joint articulation).

2.4.2 Drive Shaft Assembly Construction

Two universal joint assemblies, one "fixed" and one "slip" type shall be attached to either end of the composite drive shaft in single span designs. The attachment shall be accomplished by an engineered adhesive bond and structural riveting of a steel or composite flange machined to mate with U-joint components. The composite torque tube to flange attachment strength must exceed the strength of the substrate materials. Compression fit connections are not acceptable. The universal joint components shall be double flange type and selected based upon operating torque, misalignment capability and desired universal joint bearing B 10 life.

The composite torque tube shall consist of filament wound continuous fibers fully impregnated with an epoxy resin. It shall be of one piece construction without use of intermediate bearings and multiple sections whenever possible and practical. Priority in design will be toward one piece spacer assemblies.

Franklin Canal Pump Station

The tube materials shall be of carbon and/or E-glass continuous fibers fully impregnated with an epoxy resin system. This resin system shall be a corrosion and impact resistant epoxy thermoset polymer. Thermoplastic resins are not acceptable. The torque tube shall have a 1/8" wall thickness as a minimum.

The space shall be dynamically balanced to AGMA CLASS 9 balance criteria. Balancing procedures and certifications will be furnished upon request.

Rigid flanged hubs shall be furnished to mount onto rotating equipment shafts. These hubs shall have a precision machined bolt pattern to match the bolt pattern of the universal joint components. The hubs shall be 316 stainless steel for corrosion resistance.

2.5 EQUIPMENT APPURTENANCES

2.5.1 Attachments

All necessary bolts, nuts, washers, bolt sleeves, and other types of attachments for the installation of the equipment shall be furnished with the equipment. Bolts shall conform to the requirements of ASTM A307 and nuts shall be hexagonal of the same quality as the bolts used. Threads shall be clean-cut and shall conform to ASME B1.1. Bolts, nuts, and washers specified to be galvanized or not otherwise indicated or specified, shall be zinc coated after being threaded, by the hot-dip process conforming to ASTM A123 or ASTM A153 as appropriate. Bolts, nuts, and washers specified or indicated to be stainless steel shall be Type 316.

2.5.2 Equipment Guards

Equipment driven by open shafts, belts, chains, or gears shall be provided with all-metal guards enclosing the drive mechanism. Guard shall be constructed of galvanized sheet steel or galvanized woven wire or expanded metal set in a frame of galvanized steel members. Guards shall be secured in position by steel braces or straps which will permit easy removal for servicing the equipment. The guards shall conform in all respects to all applicable safety codes and regulations.

2.5.3 Tools

A complete set of all special tools which may be necessary for the adjustment, operation, maintenance, and disassembly of all equipment shall be furnished. Special tools are considered to be those tools which because of their limited use are not normally available, but which are necessary for the particular equipment. Special tools shall

Franklin Canal Pump Station

be high-grade, smooth, forged, alloy, tool steel. One pressure grease gun for each type of grease required for engines shall also be furnished. All tools shall be delivered at the same time as the equipment to which they pertain. Properly store and safeguard such tools until completion of the work, at which time they shall be delivered to the OWNER.

2.5.4 Painting

The pumps, engines, and the accessory equipment including, but not limited to, panels, valves, piping, intake, and exhaust system components shall be finished as indicated in the plans and as specified in 09 97 02 PAINTING: HYDRAULIC STRUCTURES.

2.5.5 Float Switch

Mechanical float switches shall be provided for each pump. Switches shall be set to shut down the engine at an elevation established by the ENGINEER for sequential shut-down of pumps. Provide opening and insert requirements and locations to platform fabricator for units that require through deck relays, connections, or other parts. Provide protective casing for mechanical float unit.

2.5.6 Vibration Monitor

Vibration monitors shall be provided for automatic shutdown of engine with excessive vibration.

2.6 DATA PLATES

A stainless steel data plate shall be mounted on each pump unit. Data plates shall contain the manufacturer's name, pump size and type, serial number, capacity in gpm at rated speed in rpm, head in feet of water, and other pertinent data.

Nameplates giving the name of the manufacturer, the serial number of the item, the horsepower, speed in rpm, and other pertinent data that is necessary to complete identification shall be attached to each engine unit.

PART 3 EXECUTION

3.1 PUMP CONSTRUCTION

3.1.1 Analysis

In order to ensure that neither harmful nor damaging vibrations occur to the pump and pump system structure at any speed within the specified operating range, the following analysis shall be required:

Franklin Canal Pump Station

Pump manufacturer shall perform a structural frequency analysis of the above ground structural components utilizing a FEA method to ensure that no structural frequencies occur within +/-20% of the operating speed range or -50% to -30% operating speed range. When deemed necessary by the experience of the manufacturer, the below ground structural components shall also be included in the analysis. The FEA method should include the use of ProE/Mechanical or approved equal software. All pump assembly components, including the motor, shall be represented as solid elements, and if idealizations are used in place of solid elements, then a complete description of method for the idealization shall be included in the report. The analysis shall also include all modes of interest and pictorially represent them in a fringe plot format. Modes of interest are defined as those structural frequencies that exist below 120% of the maximum operating speed. When significant modifications are required to lower the system's natural frequency, the pump structure's stresses and deflections shall also be reviewed. Manufacturer to provide documentation of the analysis ensuring that the specified requirements have been met, and that documentation should be signed and stamped by the professionally licensed ENGINEER who performed the analysis work.

Franklin Canal Pump Station

A torsional analysis should be run on the entire system. With engine drive systems, it is not uncommon for one or more resonate speeds to exist between zero RPM and the operating speed of the system. Continued operation at, or within 20% of a resonate speed will result in torsional vibrations which can be damaging to all components in the system. Unusual rumbling or clattering noise from the gear drive at a sharply defined speed is the most common indication of torsional vibrations. As the speed is increased or decreased, the noise will disappear. This noise is not indicative of a defect but results when the vibratory torque exceeds the drive torque causing the gear teeth in the gear drive to separate and clash together very rapidly. Transition through a resonate speed range to operating speed is not normally damaging, but operation of the system close to a resonate speed should be avoided. To avoid operation at a resonate speed it may be necessary to change the elastic characteristics of the rotating components in the system, or change the speed of the engine with respect to the pump. Any modifications to system components to avoid operation at resonate frequencies shall be made at no cost to the owner. Drive shaft systems shall be so designed that gear box and drive shaft are matched so that critical speed of drive shaft is minimum of 25% or greater than the maximum engine operating rpm. The torsional analysis should be done by the engine manufacturer. If the engine manufacturer is not qualified, an independent CONTRACTOR should be used.

3.1.2. Vibration

When measured in the direction of maximum amplitude on the pump and motor bearing housings, vibration shall not exceed limits given in the latest ANSI/HI nomograph for the applicable pump type.

3.1.3 Balance

All rotating parts of the equipment shall operate throughout the required range without excessive end thrust, vibration, or noise. Defects of this type that cannot be eliminated by installation adjustments will be sufficient cause for rejection of the equipment. Pump impeller assemblies shall be statically and dynamically balanced to within 1/2 percent of W times R squared, where W equals weight and R equals impeller radius. Shaft construction shall be substantial to prevent seal or bearing failure due to vibration. Total shaft peak-to-peak dynamic deflection measured by vibrometer at pump-seal face shall not exceed 2.0 mils under shutoff-head operating conditions. Flow from 1/4 inch iron pipe size (ips) pipe shall be provided during testing.

3.2 INSTALLATION

Install each pump and engine in accordance with the written instructions of the manufacturer and under the direct supervision of

Franklin Canal Pump Station

the manufacturer's representative. Install engine fuel supply system as indicated and in conformance with NFPA 30 and NFPA 37. Furnish foundation bolt requirements for proper positioning during the casting of the concrete platform panels.

3.2.1 System Coordination

Prior to installation, submit drawings containing complete wiring and schematic diagrams and any other details required to demonstrate that the system has been coordinated and will properly function as a unit. Show proposed layout and anchorage of equipment and appurtenances, and equipment relationship to other parts of the work including clearances for maintenance and operation. Provide a complete listing of equipment and materials.

3.2.2 Operating Instructions

Submit proposed diagrams, instructions, and other sheets, prior to posting. Approved wiring and control diagrams showing the complete layout of the entire system, including equipment, piping valves, and control sequence, framed under glass or in approved laminated plastic, shall be posted where directed. Condensed operating instructions explaining preventive maintenance procedures, methods of checking the system for normal safe operation, and procedures for safely starting and stopping the system shall be prepared in typed form.

3.3 FIELD TESTS

After installation of the pumping units and appurtenances is complete, carry out operating tests to assure that the pumping installation operates properly. Tests shall assure that the units and appurtenances have been installed correctly, that there is no objectionable heating, vibration, or noise from any parts, and that all manual and automatic controls function properly. If any deficiencies are revealed during any tests, such deficiencies shall be corrected and the tests shall be reconducted.

3.3.1 Procedures

Subject each pumping unit to a running field test in the presence of the ENGINEER and OWNER's representative for a minimum of 2 hours. Operate each pumping unit at its rated capacity or such other point on its head-capacity curve selected by the Contracting Officer. Provide an accurate and acceptable method of measuring the discharge flow.

3.3.2 Reporting

Franklin Canal Pump Station

Submit test reports in booklet form showing all field tests performed to adjust each component and all field tests performed to prove compliance with the specified performance criteria, upon completion and testing of the installed system. Each test report shall indicate the final position of controls.

3.4 FIELD PAINTING

Do not paint stainless steel, galvanized steel, and nonferrous surfaces.

3.4.1 Touch-Up Painting

Touch-up painting shall be in accordance with Section 09 97 02 - PAINTING: HYDRAULIC STRUCTURES.

3.4.2 Exposed Ferrous Surfaces

Exposed ferrous surfaces shall be painted in accordance with Section 09 97 02 - PAINTING: HYDRAULIC STRUCTURES.

3.5 CLOSEOUT ACTIVITIES

3.5.1 Training

Upon completion of the work, and at a time designated by the ENGINEER, the services of one or more competent ENGINEERS shall be provided for a training period of not less than 4 hours to instruct a representative of the OWNER in the contents of the operation and maintenance manuals for the equipment furnished under these specifications. These field instructions shall cover all the items contained in the bound operating instructions. Submit the names and qualifications of the training ENGINEERS and written certification from the manufacturer that the trainers are technically qualified. Also, submit the training course curriculum and training instructions to the ENGINEER 14 days prior to the start of training.

3.5.2 Operation and Maintenance Manuals

Submit complete sets of instructions containing the manufacturer's operating and maintenance instructions for each piece of equipment. One complete set at the time the tests procedure is submitted; remaining sets before the contract is completed. Permanently bind each set, including a hard cover. Place flysheets before instructions covering each subject. Instruction sheets shall be approximately 8-1/2 by 11 inches, with large sheets of drawings folded in.

Instructions shall include, but not be limited to, the following:

Franklin Canal Pump Station

- a. System layout showing piping, valves, and controls.
- b. Approved wiring and control diagrams.
- c. A control sequence describing startup, operation, and shutdown.
- d. Operating and maintenance instructions for each piece of equipment, including lubrication instructions and troubleshooting guide.
- e. *Manufacturer's bulletins, cuts, and descriptive data; and parts list and recommended spare parts and suppliers.*
- f. Settings and adjustment for protective devices.
- g. List of all tools, handling devices, and spare parts furnished.

3.5.3 Special Warranty Period

All components contained within this section shall be warranted as a complete unit by the contractor from a period of 3 years from the substantial completion date. This Special Warranty provided by contractor shall not replace any individual factory manufacturer's standard warranties that may extend beyond 3 years. Upon completion of the project the contractor shall provide owner with statement of Special Warranty along with any manufacturer's warranties. Such Special Warranty shall not contain exclusion requiring owner to purchase service plan and or maintenance plans. Warranty may provide the name of a third party to the perform warranty repairs, but prime contractor shall remain the responsible party for the three years period.

-- End of Section --

APPENDICES

APPENDIX A
GEOTECHNICAL REPORT



EUSTIS ENGINEERING SERVICES, L.L.C.

3011 28TH STREET
METAIRIE, LOUISIANA 70002-6019
PN 504-834-0157 | FN 504-834-0354
EMAIL: INFO@EUSTISENG.COM | SITE: WWW.EUSTISENG.COM

20 January 2010

Miller Engineers & Associates, Inc.
Post Office Box 223
Franklin, Louisiana 70538

Attention Mr. Reid A. Miller, P.E.

Gentlemen:

Geotechnical Investigation
St. Mary Parish Levee District
Floodgate Structure at Franklin Drainage Canal
St. Mary Parish, Louisiana
Miller Engineers & Associates, Inc., Project No. 12940
Eustis Engineering Project No. 20749

Transmitted are two bound copies of our report covering a geotechnical investigation for the subject project. One copy is also being sent to Shaw Coastal, Inc., to the attention of Ms. Hilary Thibodeaux. Thank you for asking us to perform these services.

Yours very truly,

EUSTIS ENGINEERING SERVICES, L.L.C.

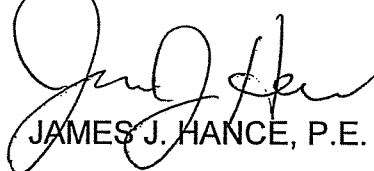
JAMES J. HANCE, P.E.

JJH:jdd/jkd

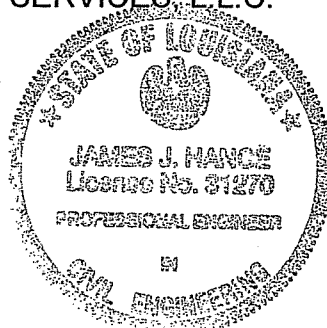

GEOTECHNICAL INVESTIGATION
ST. MARY PARISH LEVEE DISTRICT
FLOODGATE STRUCTURE AT FRANKLIN DRAINAGE CANAL
ST. MARY PARISH, LOUISIANA
MILLER ENGINEERS & ASSOCIATES, INC., PROJECT NO. 12940
EUSTIS ENGINEERING PROJECT NO. 20749

FOR
MILLER ENGINEERS & ASSOCIATES, INC.
FRANKLIN, LOUISIANA

By
Eustis Engineering Services, L.L.C.
Metairie, Louisiana

20 JANUARY 2010

TABLE OF CONTENTS

	<u>PAGE</u>
INTRODUCTION	1
COMPUTER PROGRAMS	1
GEOTECHNICAL AND HYDRAULIC DESIGN CRITERIA	2
GENERAL CRITERIA	3
BORING AND LABORATORY DATA	3
SUBSOIL CONDITIONS	5
FOUNDATION ANALYSES	5
Site Preparation	6
Lateral Earth Pressures	7
Axial and Lateral Capacity of Pile Foundations	7
Deep-Seated Stability Analyses of Pile Supported Structures	8
Piping Analyses (Sheetpile Tip Elevations)	10
Stability Analyses of Proposed Levee	10
Settlement Potential of Earthen Levees	11
Settlement Analyses of Pile Foundations	11
Installation of Driven Piles	12
ADDITIONAL GEOTECHNICAL SERVICES	14
LIMITATIONS	15
FIGURES 1 THROUGH 12	
APPENDICES I THROUGH III	

GEOTECHNICAL INVESTIGATION
ST. MARY PARISH LEVEE DISTRICT
FLOODGATE STRUCTURE AT FRANKLIN DRAINAGE CANAL
ST. MARY PARISH, LOUISIANA
MILLER ENGINEERS & ASSOCIATES, INC., PROJECT NO. 12940
EUSTIS ENGINEERING PROJECT NO. 20749

A. INTRODUCTION

Geotechnical recommendations and analyses were developed by Eustis Engineering Services, L.L.C., in support of design of flood protection as part of the floodgate structure at Franklin Drainage Canal near the Centerville Pump Station in St. Mary Parish. A site vicinity map is shown on Figure 1. We performed this work in accordance with our proposal to Miller Engineers & Associates, Inc., dated 8 July 2009 that was authorized by Mr. William Hidalgo, President of St. Mary Parish Levee District, on 30 July 2009.

The flood protection comprises a swinging barge gate and receiving structure in the Franklin Drainage Canal, new levee on the eastern side of the Yokley Canal that will tie into the existing levee running southeast to northwest near the existing pump station, and braced walls that extend from the gate and tie into the proposed levee sections. Stability analyses of the barge gate and the proposed levee were performed using Spencer's Method and Method of Planes. This geotechnical report includes stability analyses, settlement analyses of pile foundations due to fill loads and structural loads, estimates of relationship between horizontal soil reaction and lateral pile deflection (p-y) curves, seepage analyses, and pile capacity estimates.

B. COMPUTER PROGRAMS

The following computer programs were used in our evaluations.

- (1) Stability Analysis, Spencer's Method using SLOPE/W, Version 7.15, Geo-Slope International, Ltd.
- (2) Method of Planes (MOP) Stability Analyses by Lower Mississippi Valley Division (LMVD), Uplift, U.S. Army Corps of Engineers.
- (3) P-Y Data for Driven Piles, LPILE, Version 5.0, Ensoft, Inc.
- (4) Settle^{3D}, Version 2.0, Rocscience.

C. GEOTECHNICAL AND HYDRAULIC DESIGN CRITERIA

The project design criteria used in the geotechnical analyses are described in detail in the U.S. Army Corps of Engineers' document entitled "Hurricane and Storm Damage Risk Reduction System" (HSDRRS) design guidelines dated 23 October 2007. The geotechnical section was updated on 12 June 2008. A summary of the criteria and required factors of safety is presented in Table 1.

TABLE 1: GEOTECHNICAL DESIGN CRITERIA

ITEM	LOADING CONDITIONS		FACTOR OF SAFETY	CONDITION
	WATER LEVEL	SHEAR STRENGTH PARAMETERS		
Pile Capacity	N/A	Q	2.0	With Load Test
	N/A	Q	3.0	Without Load Test
	N/A	Q	2.5	With Dynamic Pile Test
	N/A	S	1.5	With or Without Load Test
Flood Gate Stability Spencer's Method	SWL	Q	1.5	If Target Factor of Safety is Not Achieved, Determine Required Unbalanced Force to Achieve this Target Factor of Safety
	EWL	Q	1.4	
Flood Gate Stability Method of Planes	SWL	Q	1.3	
	EWL	Q	1.2	
Levee Stability Using Spencer's Method	SWL	Q	1.5	
	EWL	Q	1.4	
	LWL	Q	1.4	
Levee Stability Using Method of Planes	SWL	Q	1.3	
	EWL	Q	1.2	
	LWL	Q	1.3	

SWL = Still Water Level; EWL = Extreme Water Level; LWL = Low Water Level
 Q = Unconsolidated Undrained Shear Strengths
 S = Consolidated Drained Shear Strengths

Hydraulic design criteria were provided by the USACE as presented in Table 2. The application of factors of safety is discussed in detail in this report.

TABLE 2: HYDRAULIC DESIGN CRITERIA

DESIGN WATER CONDITIONS	ELEVATION (NAVD 88)
SWL (Braced Sheetpile Walls, and Barge Swing Gate)	7.0
EWL (Braced Sheetpile Walls, and Barge Swing Gate)	9.5
LWL	1.0

D. GENERAL CRITERIA

The following represents the typical procedure for the geotechnical design and analysis of flood protection structures. The procedures stated herein, although considered typical, are in no way implied to eliminate engineering judgment. The HSDRRS design guidelines shall supersede all applicable EM and ETL criteria.

- EM 1110-2-1902, Slope Stability (Oct. 03)
- EM 1110-2-1901, Seepage Analysis and Control for Dams (Apr. 93)
- EM 1110-2-2906, Design of Pile Foundations (Jan. 91)
- DIVR 1110-1-400, Soil Mechanic Data (Dec. 98)
- ETL 1110-2-569, Design Guidance for Levee Underseepage (May 05)

E. BORING AND LABORATORY DATA

1. Prior Investigation. Geotechnical data were available near the project site and were incorporated into our current suite of analyses. The previous investigation used was Eustis Engineering’s geotechnical report entitled, “U.S. Army Corps of Engineers, Franklin Canal Section Gate Structure Project, New Orleans, Louisiana, Contract No. DACW29-98-D-0003, Work Packet No. 8, Requisition No. W42HEM-8126-1114” dated 3 November 1999. This work was performed under Eustis Engineering Project No. 15408. Borings used from the previous report were denoted as FC-1U, FC-2U, and FC-3U and were furnished by the USACE. These borings were 5 inches in diameter.
2. New Investigation. Three undisturbed soil test borings were performed at the project site between 31 August and 3 September 2009 and were denoted as Borings B-1 through B-3. These borings were made to supplement soil data from the previous investigation performed near the site. Borings B-1 and B-2 were washed down (i.e., no sampling) to an approximate depth of 70 feet below the existing ground surface because geotechnical data were already available in the upper 70 feet. These borings were taken on the northern and southern sides of Franklin Canal. Samples for Borings B-1 and B-2 were obtained between the 70 and 150-ft depths. Boring B-3 was drilled and sampled from the existing ground

surface to an approximate depth of 80 feet below the existing ground surface at the location of the proposed levee. The borings were located in the field by Miller Engineers & Associates. These new borings were 3 inches in diameter and made with a truck mounted rotary type drill rig. Upon completion of drilling operations, the borings were backfilled in accordance with current regulatory requirements. A plan view of the previous and new boring locations is provided on Figure 2. Detailed descriptive logs of the previous and new borings are shown in both tabular and graphical form in Appendix I. The approximate latitude and longitude of the new boring locations were obtained in the field with the use of a handheld GPS device. These coordinates can be found on the boring logs in Appendix I. The locations, depths, GPS coordinates, and ground surface elevations of the previous and new soil borings are summarized in Table 3.

TABLE 3: GENERAL GEOTECHNICAL INFORMATION

BORING NUMBER	BORING DIAMETER (INCHES)	BORING DEPTH BELOW GROUND SURFACE (FEET)	GROUND SURFACE ELEVATION (NAVD 88)	LATITUDE (NORTH)	LONGITUDE (WEST)
B-1	3	150	9.1	29° 46' 59.160"	91° 31' 40.380"
B-2	3	150	4.5	29° 47' 01.380"	91° 31' 41.220"
B-3	3	80	4.5	29° 47' 04.560"	91° 31' 41.400"
FC-1U	5	75	6.5	See Note 1.	
FC-2U	5	60	-4.2		
FC-3U	5	60	4.7		

Note 1: GPS coordinates were not available for the borings furnished by the USACE that were obtained in January and February 1996. Approximate boring locations are shown on Figure 2.

3. Field Investigation (New Boring). Cohesive or semi-cohesive subsoils were sampled at close intervals or changes in strata using a 3-in. diameter thinwall Shelby tube sampling barrel. The undisturbed samples were immediately extruded from the sampling barrel in the field. Pocket penetrometer tests were performed on trimmed ends of the extruded samples to provide a general indication of the soil's shear strength or consistency. The results of these tests are shown on the boring logs in Appendix I under the column heading "PP." All samples were inspected and visually classified by Eustis Engineering's soil technician. Representative portions of the samples were placed in moisture proof containers and returned to Eustis Engineering's laboratory for additional testing.
4. Laboratory Testing (New Boring). Soil mechanics laboratory tests, consisting of natural water content, unit weight, and either unconfined compression shear (UC) or one-point unconsolidated undrained triaxial

compression shear (OB), were performed on undisturbed samples obtained from the borings. These tests aid in classification of the subsoils and give an indication of their relative compressibility. The results of these laboratory tests are summarized on the boring logs in Appendix I.

In addition, consolidation tests (CON) and Atterberg liquid and plastic limits tests were performed on selected samples to determine their compressibility and stress history. The results of these tests are shown on separate sheets in Appendix II.

F. SUBSOIL CONDITIONS

1. Geology. The proposed site of the Franklin Canal floodgate is located within the Louisiana Gulf Coastal Plain. The site is located on the western alluvial floodplain of Bayou Teche, one of the oldest major river courses of the ancient Mississippi River. As a result, the substratum at the site consists of a surficial deposit of medium stiff to stiff natural levee clays approximately 10 feet thick. These natural levee deposits are underlain by a 30-ft layer of medium stiff to stiff interdistributary clays, which are in turn underlain by stiff to very stiff Pleistocene clay with isolated pockets and layers of silty sand. This stratigraphy is identified graphically as a geologic profile on Figure 3. From a geotechnical design standpoint, the entire area can be addressed as a single geologic reach.
2. Ground Water. Ground water is expected within 5 feet of the existing ground surface. The depth to ground water will fluctuate with changes in climatic conditions, site drainage, water levels in the nearby Franklin Canal and Yokley Canal, and other factors. For this reason, the depth to ground water should be determined by those persons responsible for construction immediately prior to beginning work.
3. Soil Parameters. Soil design parameters were developed for geotechnical data obtained from both the previous and new borings. Soil design parameters used for geotechnical analyses for preparation of this report comprise shear strength, unit weight, and moisture content and are plotted versus elevation on Figure 4. The new levee will be constructed of computed clay borrow. Design parameters for compacted clay are 110 pcf for the total weight and 400 psf for the undrained shear strength. These parameters are in accordance with the HSDRRS design guidelines.

G. FOUNDATION ANALYSES

1. Furnished Information. The Franklin Canal floodgate project consists of the construction of earthen levees, braced walls and a navigable closure structure (swing barge gate and receiving structure) designed to meet

current USACE design criteria for the water levels listed in Table 2. Geotechnical engineering analyses were performed by Eustis Engineering to determine various design components of the structures.

2. Site Preparation

a. Clearing. The new structures will be founded a few feet below the existing ground surface/mudline. The existing ground surface beneath the proposed floodwalls and earthen levee will be stripped of loose topsoil, organic matter, and other deleterious materials. Stripping will be to the minimum depth necessary to remove any deleterious materials to the base level for the structure. Special attention will be given to any weak areas or depressions discovered during the excavation operation. These areas will be cleaned out to the surface of firm soil and backfilled with a select inorganic cohesive soil. Fill material will be placed and compacted under controlled conditions. If abandoned underground utilities exist, special care will be taken in their removal. These structures could impact the performance of new foundations if not properly removed and backfilled with select fill.

b. Fill Material

i. Embankments shall be constructed of earth materials naturally occurring or contractor blended. Materials classified in accordance with ASTM D 2487 as CL or CH with less than 35% sand content are suitable for use as embankment fill. Materials classified as ML are suitable if blended to produce a material that classifies as CH or CL according to ASTM D 2487.

ii. All fill materials shall be free from masses of organic matter, sticks, branches, roots, and other debris, including hazardous and regulated solid wastes. As earth from the designated excavation areas may not be considered objectionable in the embankment provided their length does not exceed 1 foot, their cross-sectional area is less than 4 square inches, and they are distributed throughout the fill. Not more than 1% (by volume) of objectionable material shall be contained in the earth material placed in each cubic yard of the levee section. Pockets and/or zones of wood shall not be placed in the embankment.

iii. Materials placed in the levee or floodwall section must be at or above the plasticity index of 10. As a precaution,

contractors shall notify the field representative whenever the in-place plasticity index of the material is 15 or less.

- iv. Materials placed in the section must be at or below an organic content of 9% by weight, as determined by ASTM D 2974, Method C.

3. Lateral Earth Pressures

- a. Lateral pressures on buried structures will be determined using at-rest lateral earth pressure coefficients. The lateral earth pressure coefficients for various materials are shown in Table 4 and are determined in accordance with EM 1110-2-2504 (i.e., $K_o = 1 - \sin \phi$).

TABLE 4: AT-REST LATERAL EARTH PRESSURE COEFFICIENTS

LATERAL	AT-REST LATERAL EARTH PRESSURE COEFFICIENT (K_o)
In Situ Clay or Clay Fill Soils	1.00
Select Structural Sand Fill (Not Anticipated)	0.53

4. Axial and Lateral Capacity of Pile Foundations

- a. Design Methods and Assumptions. Computations were made to determine the estimated ultimate single pile load capacities for 24-in. square, precast concrete piles and for various sizes of open end steel pipe piles. These calculations are part of Step 3 of the USACE T-wall design procedure. Capacities were computed for piles driven for support of the T-walls and barge gate. The pile capacities were computed for Q-case (i.e., short-term undrained loading conditions) soil parameters. Based on our experience with pile capacity, the Q-case governs the design in comparison to S-case (long-term, drained loading conditions) in a soft clay foundation environment. The analyses followed EM 1110-2-2906 and Section 3.3 of the HSDRRS design guidelines.
- b. Protrusion of Connections or Welds. Pile connections that protrude beyond the surface of the outside wall of the pile reduce the frictional resistance acting on the pile surface above the protrusion. For this reason, we recommend against the use of spiral welded piles and closed end pipe piles. We further recommend all pile welds be ground flush with the surface of the pile. If the welds protrude past the pile's outside dimensions, the soil-pile adhesion is

disturbed during installation of the pile and the pile's capacity may be reduced. For similar reasons, connectors for precast concrete piles should be completely contained within the perimeter of the pile section.

- c. Results. The estimated **ultimate** load capacities for piles installed at the project site are provided on Figures 5 and 6. Unbalanced loads were not found in the stability analysis of the barge gate. Therefore, contribution to axial pile capacities can be considered below the bottom of the structure.
- d. Pile Group Capacity and Spacing. Piles will derive a majority of their supporting capacity from skin friction. Therefore, it will be necessary to consider the effect of group action. In this regard, the supporting value of the piles driven in groups should be investigated on the basis of group perimeter shear by the formula shown on Figure 7. The minimum spacing between piles will be determined using the formula shown on Figure 8.
- e. Lateral Loads. Horizontal and axial components of batter piles will be determined from geometry using the formula shown on Figure 9. We also computed horizontal soil reaction versus deflection (p-y) curves for piles having 12, 24, 36, 42, and 48-in. outside diameters or side dimensions. The results of our analyses are provided in Appendix III. We assumed cyclic loading conditions will exist. We further assumed piles are spaced a minimum of seven pile diameters apart so no interaction exists among adjacent piles during lateral loading. Eustis Engineering recommends lateral load and soil response analyses be performed on the pile groups. We understand Shaw Coastal, Inc., of Houma, Louisiana, is performing the group analysis. In the event piles are spaced closer than seven pile diameters (center to center distance), a reduction in ultimate soil reaction resisting the applied loads and/or an increase in the pile deflection required to mobilize a given soil reaction may be necessary to account for group effects.

5. Deep-Seated Stability Analyses of Pile Supported Structures

- a. Design Methods and Assumptions. Deep-seated stability analyses were performed for the proposed barge gate foundations. The analyses followed the criteria provided in the HSDRRS design guidelines. The guidelines require analyses by the Spencer's Method for non-circular failures and the Method of Planes Analyses. ***According to the guidelines, Spencer's Method should be used for design, and the Method of Planes is only a***

check for the New Orleans District (i.e., Method of Planes should not be used in the design). The Method of Planes Analyses procedure will be described later. For the Spencer's Method analyses, if the factor of safety of a critical surface was greater than that required in Table 1 of this report, then a stabilizing resisting force against deep-seated instability was not required to be carried by the pile supported structure. If the factor of safety of the critical failure surface is less than required, the analyses proceeded to Step 2 of the guidelines.

- b. Step 2 includes determination of the unbalanced force necessary to achieve the required minimum factor of safety. The unbalanced force is arrived at through trial and error process where the load is varied until the desired factor of safety is achieved. The critical failure plane is defined as a failure surface that produces the greatest unbalanced load. Where unbalanced loads are present, the axial pile capacity developed above the critical failure plane should be disregarded.
- c. Step 3 of the design includes computation of allowable axial capacity. In addition, computation of allowable shear loads on individual piles at the critical failure surface is made using the program LPILE by Ensoft, Inc. These analyses were performed and are included in Appendix III as previously noted.
- d. The structural analysis for this project was performed by Shaw Coastal.
- e. The structures were also analyzed by the Method of Planes for EWL and SWL conditions. For the Method of Planes analyses, the resisting forces are reduced by the required factor of safety shown in Table 1. In addition, the free water against the wall is subtracted from the driving forces. If the driving forces less the sum of the free water force and the resisting forces divided by the appropriate factor of safety are positive at any particular wedge level, an unbalanced force is calculated. If the number is negative, no unbalanced forces are required. If an unbalanced force exists, the unbalanced load is distributed between the failure analyses depth and the ground surface.
- f. Results. Results of the stability analyses by the Spencer's Method and Method of Planes are presented on Figure 10 (Sheets 1 through 4). Unbalanced loads are not required for the EWL and SWL case for both Spencer's Method and Method of Planes. Axial

pile capacity should be considered for the entire embedment of the pile.

- g. Evaluation of Braced Wall. Eustis Engineering did not evaluate deep-seated stability of the braced wall. We understand Shaw Coastal is analyzing this wall using conventional lateral earth pressure theory.

6. Piping Analyses (Sheetpile Tip Penetrations)

- a. Design Methods and Assumptions. Piping potential was evaluated beneath the barge gate using the Lane's Weighted Creep Ratio (LWCR) and Harr's Method, and sheetpile tip penetrations were established to achieve suitable values considering these two methods. Sheetpile tip penetrations were designed to provide minimum LWCRs of 3 (clay) and 8.5 (silt and sand). We considered a head differential across the barge gate of 8.5 feet. For Harr's Method, critical exit gradients are estimated for subsoils on the protected side of the sheetpile. The factor of safety is taken as the ratio of critical exit gradient to the exit gradient provided by sheetpile penetration. A minimum factor of safety of 2 was considered acceptable for the predominantly clay foundation. We recommend a minimum sheetpile tip of el -20 for a mudline el -5 and considering the LWCR and Harr's Method results.

7. Stability Analyses of Proposed Levee

- a. Design Methods and Assumptions. Slope stability analyses were performed for the levee constructed to el 9.5 and considering a levee crown width of 10 feet. The existing ground surface configuration was modeled at Station 5+00. The analyses were performed by the Spencer's Method for circular and noncircular slip surfaces including the optimization search routine. Analyses were also performed using the Method of Planes. Geosynthetic reinforcement was not modeled into the design of the levee.
- b. Results. The results of these analyses are presented on Figure 11 (Sheet 1 through 6). The top of levee elevation is 9.5 with a slope of 4 horizontal to 1 vertical (4H:1V) to el 4.0. A slope of 4H:1V is suitable to satisfy the minimum factor of safety required for EWL, SWL, and LWL cases for both stability methods as shown in Table 1.

8. Settlement Potential of Earthen Levees

- a. Levees are planned to be constructed to el 9.5. With existing grades of approximately el 4 to el 5, approximately 5 feet of compacted clay fill will be required to form the levee section. The foundation soils at the site are predominantly medium stiff to stiff clays and silty clays, and we do not anticipate significant settlement. However, settlement potential does exist in the foundation soils as well as shrinkage potential in levee fill materials. For this reason, a levee raise may be required in the future to maintain a flood protection level at el 9.5.

9. Settlement Analyses of Pile Foundations

- a. We considered settlement due to structural loads and settlement due to fill placement (downdrag) for the pile supported structures. Due to the complexity of the fill slopes and configurations of the levee transitions in addition to structural loads, a three-dimensional settlement model was developed in the Settle^{3D} software by Rocscience. Version 2.0 of this software allows use of the Westergaard model for computation of stresses.
- b. Estimated Settlement due to Structural Loads. Long-term settlement due to sustained structural load was evaluated with the sustained loading acting on the pile group as an equivalent footing at a depth of two-thirds down the pile length, and settlement was computed at the pile tip elevations. Long-term settlement of individual pile foundations due to sustained structural loads is anticipated to be limited to ¼ inch. Piles will need to extend to approximate el -60 or deeper to limit the long-term settlement to ¼ inch. Piles subjected to downdrag (negative skin friction) due to fill placement in combination with sustained structural loads will result in larger settlements as described in the next section of this report. This estimate does not include the elastic deformation of the piles. Elastic deformation will be estimated as 67% to 75% of the static column strain. Elastic deformation can better be defined during the pile load test program.
- c. Estimated Settlement due to Fill Placement. Downdrag is a settlement phenomenon caused by fill placement. Riprap is planned within the canal on the flood side and protected side of the structure as well as the northern and southern banks of the canal. Compacted clay levee embankments of approximate heights of 6.5 feet above existing grade are planned on the northern side of Franklin Canal. Table 4 summarizes downdrag settlement and

structural load settlement results for various sizes and pile sizes and tip embedments at multiple locations across the site.

TABLE 4: SUMMARY OF SETTLEMENT ANALYSES FOR PILE SUPPORTED STRUCTURES

LOCATION	PILE OUTSIDE DIAMETER/ WIDTH	PILE TIP ELEVATION	ULTIMATE CONSOLIDATION SETTLEMENT		
			SUSTAINED STRUCTURAL LOADS IN INCHES	DOWNDRAG DUE TO FILL PLACEMENT IN INCHES	TOTAL IN INCHES
Location Where Braced Wall Meets Levee Embankment (Query Point 1) Northern Bank	36-In.	-60	Negligible	¼ to ½	¼ to ½
Where Braced Wall Meets Receiving Structure/Barge Gate (Query Point 2)	36-In.	-60	Negligible	⅛ to ¼	⅛ to ¼
Center of barge gate concrete pile group (Query Point 3)	24-In.	-105	Negligible	Negligible	Negligible
Location where braced wall meets levee embankment (Query Point 4) Southern Bank	36-In.	-60	Negligible	Negligible	Negligible

10. Installation of Driven Piles

- a. Pile Driving. Close field supervision will be maintained by experienced personnel to ensure proper procedures are followed and accurate records are kept during all pile driving operations. The driving record will include the pile type, overall length, tip and butt diameters, embedment below finished grade, and number of blows per foot of penetration. An accurate driving record is especially important to verify all piles are installed to the required tip embedment and to give an indication of any unusual driving characteristics which may indicate pile breakage.
- b. Air Hammers. Generally, we recommend a single acting air hammer be used to install the precast concrete and steel pipe piles. The manufacturer's rated energy required to drive the piles will depend on the piles' ultimate compressive capacity. Table 5 shows the estimated hammer energy versus ultimate compressive capacity for some of the piles recommended in this report. For precast concrete piles, we also recommend the ram stroke be

limited to 3 feet and the ram weight be approximately one-half of the pile weight.

TABLE 5: ESTIMATED HAMMER ENERGY VERSUS ULTIMATE COMPRESSIVE CAPACITY

ESTIMATED ULTIMATE SINGLE PILE LOAD COMPRESSIVE CAPACITY IN TONS FACTOR OF SAFETY = 1	APPROXIMATE RATED SINGLE ACTING HAMMER ENERGY IN FT-LBS PER BLOW
Up to 120	19,500
120 to 240	24,000
240 to 300	32,000
300 to 400	42,000

- c. Diesel Hammer. In lieu of an air hammer, a diesel hammer may also be used for the installation of the concrete and steel pipe piles. We recommend the diesel hammer have a rated energy of one and one-half times the energy recommended for a comparable installation with a single acting air hammer.
- d. Pile Refusal. Refusal criteria for the concrete and steel pipe piles should be determined based on the results of the test pile program and dynamic analyses or testing. If the piles are driven with the aid of a follower, or if the pile driving helmet is allowed to impact the ground surface, Eustis Engineering should be consulted to adjust these refusal criteria.
- e. Driving Shoe. Based on the subsoil conditions at the site, we do not recommend the use of a driving shoe to assist with the installation of the precast concrete piles. It has been our experience these features create installation impediments and may reduce pile capacity.
- f. Alternate Installation Methods. We do not recommend vibratory methods be utilized for pile installation. If a vibratory hammer is selected for the project, Eustis Engineering should be contacted to evaluate the reduction in the estimated ultimate pile load capacities presented. Also, we do not recommend the use of jetting to aid in the installation of the piles. Eustis Engineering should be consulted if these measures are allowed as this will also reduce the estimated capacities presented. If any other alternate installation methods are selected, Eustis Engineering should be contacted to evaluate the effects on our estimates of capacity presented.

9. WEAP Analysis. A wave equation analysis of piles (WEAP) can be performed on intended precast concrete and steel pipe piles when planned piles and hammers have been selected. The WEAP analysis will evaluate the suitability of the hammer and determine potential damage and the need for changes in driving operations.
10. Dynamic Pile Tests. Steel and concrete piles can be monitored and evaluated by a DPT using a Pile Driving Analyzer[®] during the pile's installation. The PDA will monitor driving stresses during installation and evaluate pile integrity during installation. The PDA will also evaluate installation efficiency by monitoring the energy transferred to the pile by the hammer.

Consideration may also be given to performing DPT to evaluate pile capacity. If this is the case, these piles should be evaluated by restrike DPT and subsequent CAPWAP[®] analyses. The restrikes should be performed no earlier than 21 days after initial installation. If DPT is used exclusively to evaluate pile capacity (no static test), note the required factor of safety is increased from 2.0 to 2.5 as shown Table 1 of this report.

11. Static Load Tests. A series of load tests may be performed on piles considered for the project. The number of load tests will depend on the project features and will be provided during preparation of the plans and specifications. In general, load tests should be performed in accordance with ASTM D 1143. Project specifications will require load tests to failure or 300% of design load, whichever is achieved first. Static load tests will be performed no earlier than 21 days after initial pile installation.

H. ADDITIONAL GEOTECHNICAL SERVICES

1. To provide continuity between the design and construction phases, Eustis Engineering should be retained to provide additional services during completion of the project. These services should include additional consultation as the designs are furthered.
2. Eustis Engineering can provide construction phase services that may include compaction and density tests of select fill materials; consultation during construction; review geotechnical aspects of plans and specifications; log the installation of test piles and job piles; perform load tests and evaluate their results; steel, concrete, and asphalt inspection services; and any other soils and materials testing services. Eustis Engineering offers a complete range of materials testing services which will provide quality control during construction and conformance to design specifications. Eustis Engineering can also perform WEAP analyses for

hammer approval and to evaluate pile drivability, and DPT during pile installation. We can also evaluate PDA data with respect to driving stresses, load capacity, and pile integrity, and perform CAPWAP analyses to evaluate capacity.

3. In summary, Eustis Engineering should be retained to monitor all geotechnical related work performed by the contractor. If construction problems arise, Eustis Engineering should be notified to participate in the development of solutions. This participation permits the geotechnical engineer to evaluate the effects of unanticipated conditions and propose solutions on the geotechnical design assumptions particular to the project. The design geotechnical engineer may also be able to judge how site specific soil and ground water conditions will affect the success of a proposed construction alternative.

I. LIMITATIONS

1. This report has been prepared in accordance with generally accepted geotechnical engineering practice for the exclusive use of Miller Engineers & Associates, St. Mary Parish Levee District, and Shaw Coastal for specific application to the subject site. In the event of any changes in the nature, design, or location of the proposed project features, the conclusions and recommendations contained in this report shall not be considered valid unless the changes are reviewed and the conclusions of this report are modified and verified in writing. Should these data be used by anyone other than Miller Engineers & Associates, St. Mary Parish Levee District, and Shaw Coastal, they should contact Eustis Engineering for interpretation of data and to secure any other information pertinent to this project.
2. Our findings and recommendations in this report are based on selected points of field investigation and laboratory testing. Furthermore, our findings and recommendations are based on the assumption soil conditions do not vary significantly from those found at specific exploratory locations. Variations in soil or ground water conditions could exist between and beyond the investigation points. The nature and extent of these variations may not become evident until construction. Variations in soil or ground water may require additional studies, consultation, and possible revisions to our recommendations.
3. Recommendations and conclusions contained in this report are to some degree subjective and should be used only for design purposes. This report should not be included in the contract plans and specifications. However, the results of the soil borings and laboratory tests contained in the appendices of this report may be included in the plans and specifications.

4. This report is issued with the understanding the owner or the owner's representative has the responsibility to bring the information and recommendations contained herein to the attention of the engineers for the project so they are incorporated into the plans and specifications for the project. The owner or the owner's representative also has the responsibility to take the necessary steps to see the general contractor and all subcontractors follow such recommendations. The owner or the owner's representative is responsible for submittal of this report to the appropriate governing agencies.
5. Eustis Engineering has striven to provide our services in accordance with generally accepted geotechnical engineering practice in this locality at this time. No warranty or guarantee is expressed or implied.
6. Eustis Engineering should be provided the opportunity for a general review of the final design and specifications to ensure the geotechnical recommendations are properly interpreted and implemented in the design and specifications. If Eustis Engineering is not accorded the privilege of making this recommended review, we can assume no responsibility for misinterpretation of our recommendations.
7. Our scope of services does not include an environmental assessment or an investigation for the presence or absence of wetlands; hazardous or toxic materials in the soil; surface water; ground water; or air on, below, or adjacent to the subject property. Furthermore, the scope does not include the investigation or detection of biological pollutants at the site. The term "biological pollutants" includes but is not limited to, molds, fungi, spores, bacteria, viruses, and the byproducts of any such biological organisms.

TABLE OF FIGURES

<u>TITLE</u>	<u>FIGURE</u>
SITE VICINITY MAP	1
BORING LOCATION PLAN	2
GEOLOGIC PROFILE	3
SOIL PARAMETERS	4
SPC ALLOWABLE PILE LOAD CAPACITIES	5
OSP ALLOWABLE PILE LOAD CAPACITIES	6
PILE GROUP CAPACITY	7
PILE SPACING	8
BATTER PILE	9
 BARGE GATE	
EWL (SPENCER'S METHOD)	10, SHEET 1
EWL (METHOD OF PLANES)	10, SHEET 2
SWL (SPENCER'S METHOD)	10, SHEET 3
SWL (METHOD OF PLANES)	10, SHEET 4
 LEVEE	
EWL (SPENCER'S METHOD)	11, SHEET 1
EWL (METHOD OF PLANES)	11, SHEET 2
SWL (SPENCER'S METHOD)	11, SHEET 3
SWL (METHOD OF PLANES)	11, SHEET 4
LWL (SPENCER'S METHOD)	11, SHEET 5
LWL (METHOD OF PLANES)	11, SHEET 6
 SETTLEMENT	 12

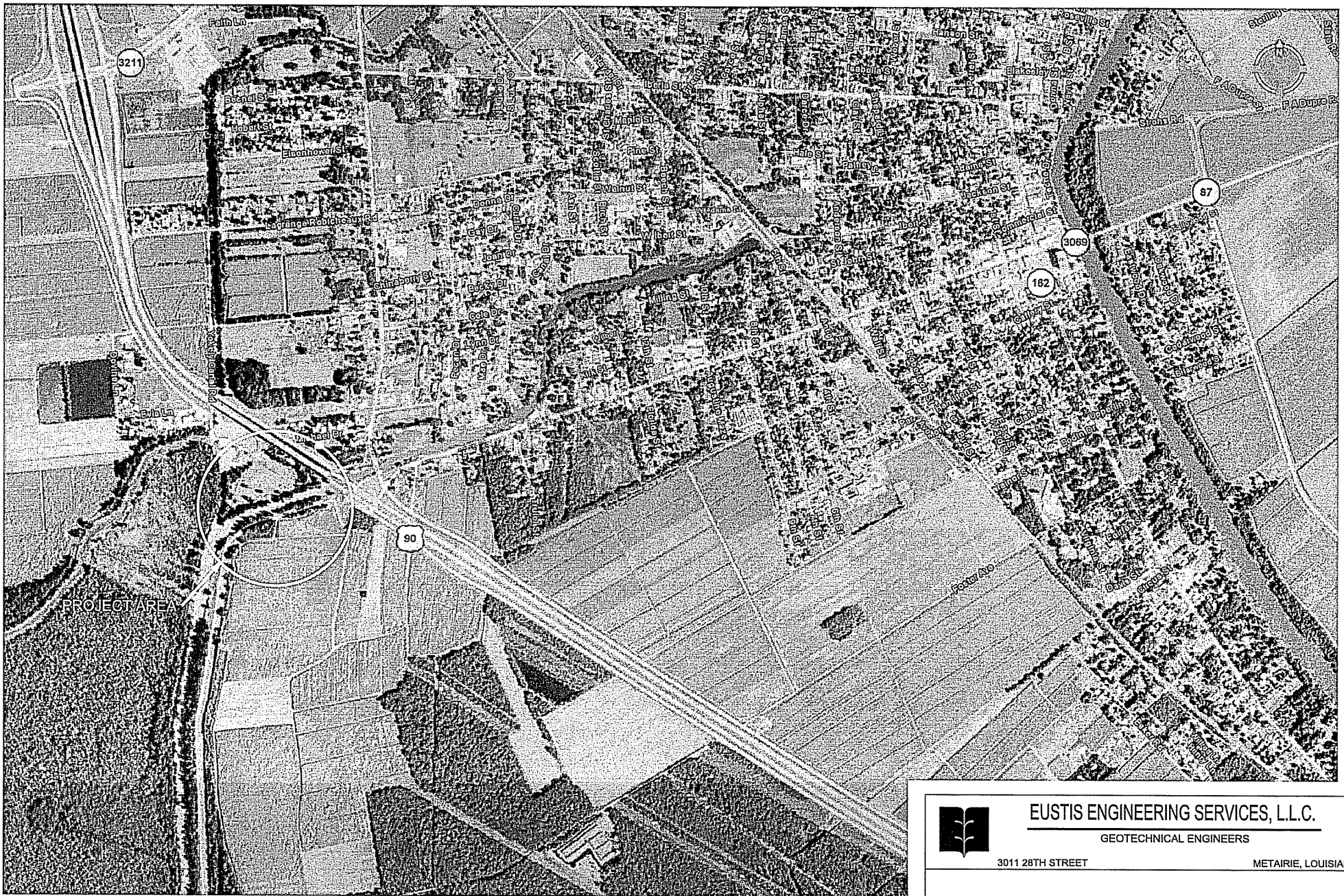

EUSTIS ENGINEERING SERVICES, L.L.C.

GEOTECHNICAL ENGINEERS

3011 28TH STREET

METAIRIE, LOUISIANA

SITE VICINITY MAP

**ST. MARY PARISH LEVEE DISTRICT
FLOODGATE STRUCTURE AT
FRANKLIN DRAINAGE CANAL
ST. MARY PARISH, LOUISIANA**

DRAWN BY: J.L.S.

PLOT DATE: 20 JAN 10

CADD FILE:
FIGURE1.DGN

CHECKED BY: M.K.M.

JOB NO.: 20749

FIGURE 1



SEE FIGURE 3 FOR
GEOLOGIC PROFILE

- ⊕ DENOTES LOCATION OF UNDISTURBED SOIL BORINGS DRILLED:
31 AUGUST THROUGH 3 SEPTEMBER 2009
- DENOTES LOCATION OF UNDISTURBED SOIL BORINGS DRILLED:
30 JANUARY THROUGH 28 FEBRUARY 1996

NOT TO SCALE



EUSTIS ENGINEERING SERVICES, L.L.C.

GEOTECHNICAL ENGINEERS

3011 28TH STREET

METAIRIE, LOUISIANA

BORING LOCATION PLAN

ST. MARY PARISH LEVEE DISTRICT
FLOODGATE STRUCTURE AT
FRANKLIN DRAINAGE CANAL
ST. MARY PARISH, LOUISIANA

DRAWN BY: J.L.S.

PLOT DATE: 20 JAN 10

CADD FILE:
FIGURE2.DGN



CHECKED BY: M.K.M.

JOB NO.: 20749

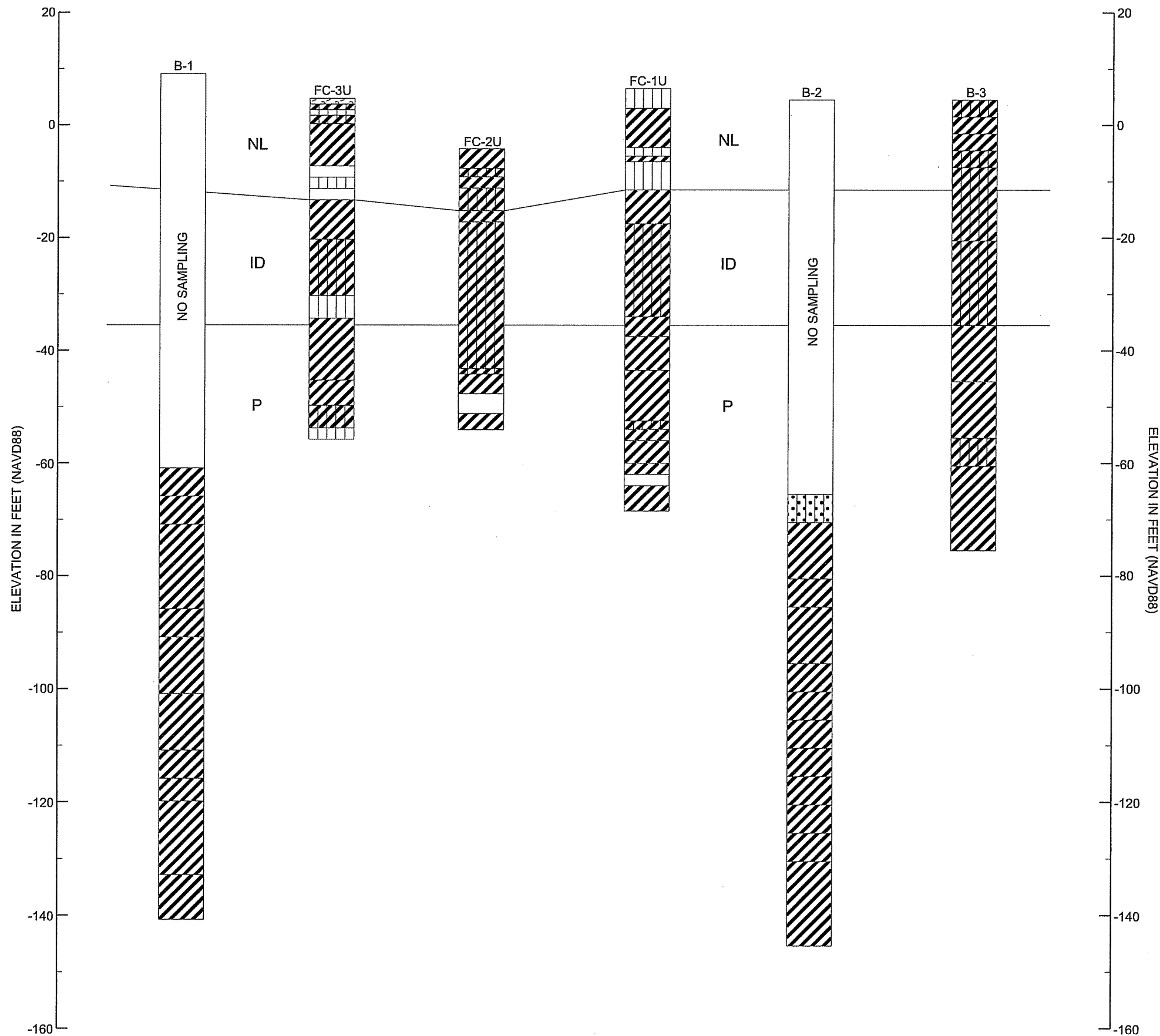
FIGURE 2



STRATA SYMBOLS

-  HIGH PLASTICITY CLAY
-  SILTY LOW PLASTICITY CLAY
-  SILTY SAND

STRATA	GEOLOGIC ORIGIN
NL	NATURAL LEVEE
ID	INTERDISTRIBUTARY
P	PLEISTOCENE



EUSTIS ENGINEERING SERVICES, L.L.C.

GEOTECHNICAL ENGINEERS

3011 28TH STREET

METAIRIE, LOUISIANA

GEOLOGIC PROFILE

ST. MARY PARISH LEVEE DISTRICT
 FLOODGATE STRUCTURE AT
 FRANKLIN DRAINAGE CANAL
 ST. MARY PARISH, LOUISIANA

DRAWN BY: J.L.S.

PLOT DATE: 20 JAN 10

CADD FILE:
FIGURE3.DGN

CHECKED BY: J.J.H.

JOB NO.: 20749

FIGURE 3

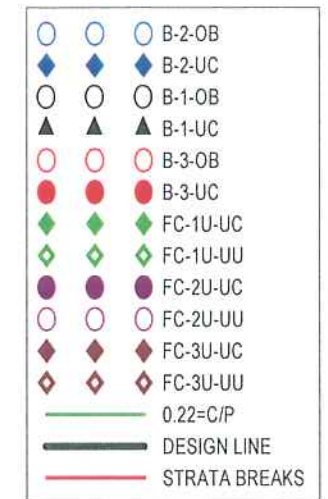
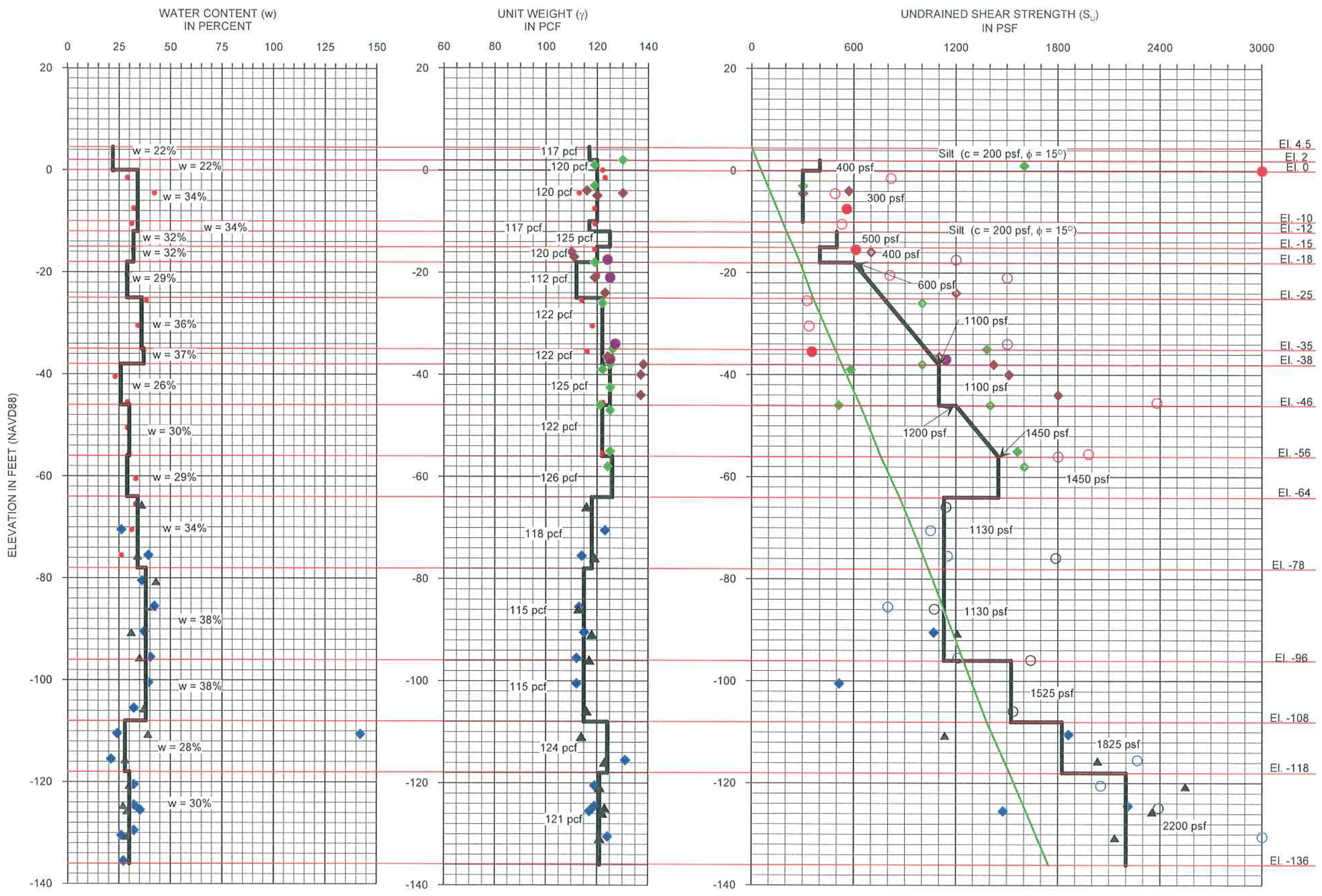

- NOTES:
1. LOGS OF SOIL BORINGS ARE PROVIDED IN APPENDIX I.
 2. DESIGN PROFILES SHOWN CANNOT FULLY ANTICIPATE ALL PARAMETERS WHICH MAY INFLUENCE SELECTION OF DESIGN VALUES FOR A SPECIFIC ANALYSIS. FOR THIS REASON, THE USER SHOULD CONTACT EUSTIS ENGINEERING SERVICES, LLC. PRIOR TO USE OF DESIGN PROFILES IN ANY ANALYSES.
 3. IN THE LEGEND SHOWN ABOVE, UC DENOTES UNCONFINED COMPRESSIVE STRENGTH TEST, OB SIGNIFIES A 1-POINT UNCONSOLIDATED, UNDRAINED TRIAXIAL COMPRESSION SHEAR STRENGTH TEST, AND UU SIGNIFIES A 3-POINT UNCONSOLIDATED, UNDRAINED TRIAXIAL COMPRESSION SHEAR STRENGTH TEST.
 4. UNIT WEIGHTS SHOWN ARE TOTAL UNIT WEIGHTS AND MUST BE APPROPRIATELY REDUCED TO EFFECTIVE STRESS STATES.
 5. FOR S-CASE, $\phi=23^\circ$ FOR ALL CLAY STRATA AND $\phi=15^\circ$ FOR SILT STRATA.

EUSTIS ENGINEERING SERVICES, L.L.C.
 GEOTECHNICAL ENGINEERS
 3011 28TH STREET METAIRIE, LOUISIANA

SOIL DESIGN PARAMETERS

ST. MARY PARISH LEVEE DISTRICT
 FLOODGATE STRUCTURE AT
 FRANKLIN DRAINAGE CANAL
 ST. MARY PARISH, LOUISIANA

DRAWN BY: A.J.B.	OCTOBER 13, 2009	FILE: SOIL PARAMETERS.GRP
CHECKED BY: JJH	JOB NO.: 20749	FIGURE 4

24-IN. SQUARE PRECAST CONCRETE PILES

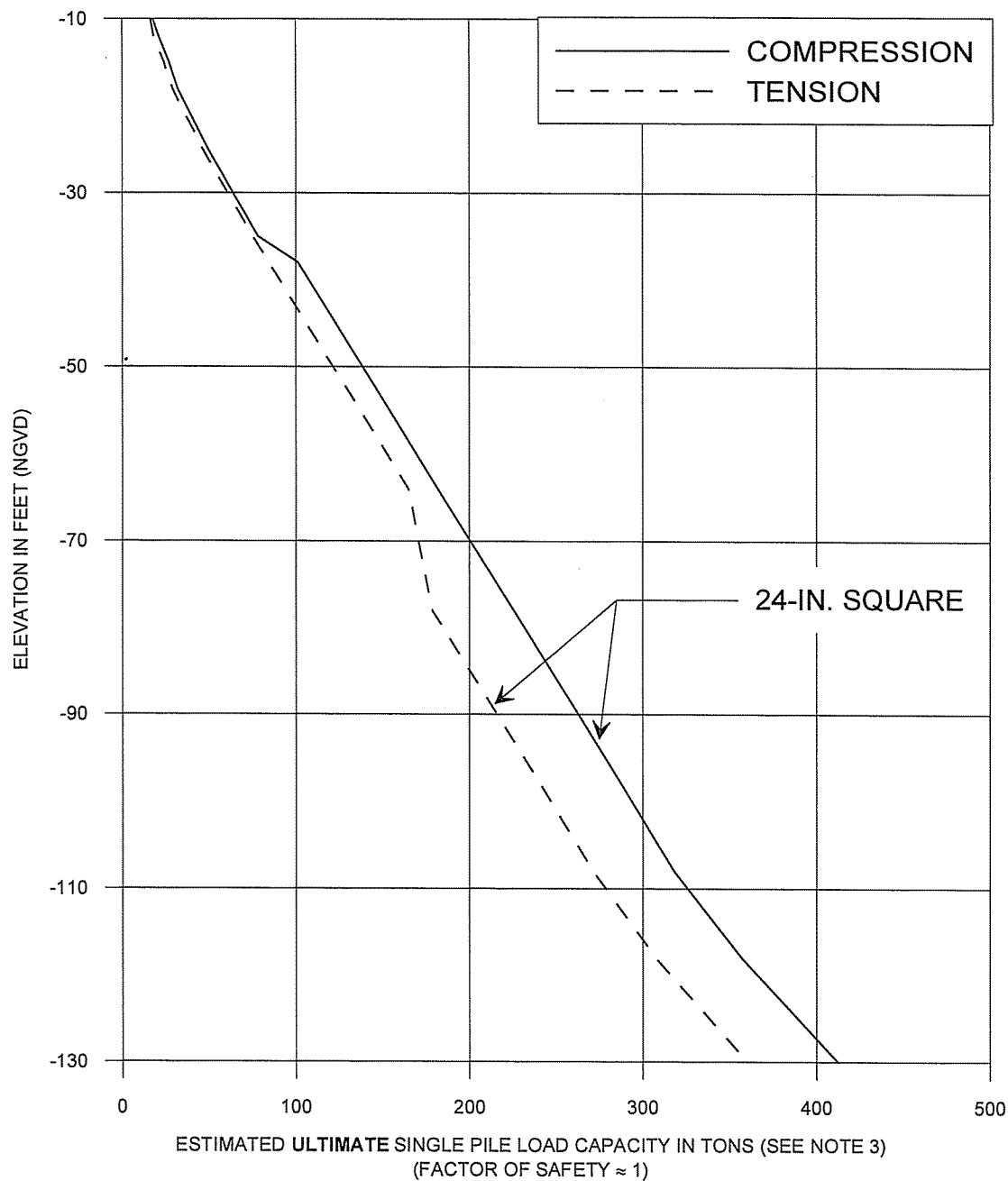

NOTES:

- 1) PILES ARE ASSUMED TO BE INSTALLED BY IMPACT DRIVING EQUIPMENT WITHOUT ASSISTANCE FROM JETTING, PREDRILLING, OR VIBRATORY EQUIPMENT.
- 2) THE PILE CAPACITIES DO NOT INCLUDE THE WEIGHT OF THE PILE.
- 3) A FACTOR OF SAFETY EQUAL TO 2 MAY BE USED IF STATIC PILE LOAD TESTING IS PERFORMED, AND A FACTOR OF SAFETY EQUAL TO 3 SHOULD BE USED IF STATIC TESTING IS NOT PERFORMED.

	EUSTIS ENGINEERING SERVICES, L.L.C. GEOTECHNICAL ENGINEERS	
	3011 28TH STREET METAIRIE, LOUISIANA	
ESTIMATED ULTIMATE SINGLE PILE LOAD CAPACITIES 24-IN. SQUARE PRECAST CONCRETE PILES -Q- CASE		
ST. MARY PARISH LEVEE DISTRICT FLOODGATE STRUCTURE AT FRANKLIN DRAINAGE CANAL ST. MARY PARISH, LOUISIANA		
DRAWN BY: D.J.I.	6 NOVEMBER 2009	FILE: SPC.GRF
CHECKED BY: J.J.H.	JOB NO.: 20749	FIGURE 5

OPEN END STEEL PIPE PILES

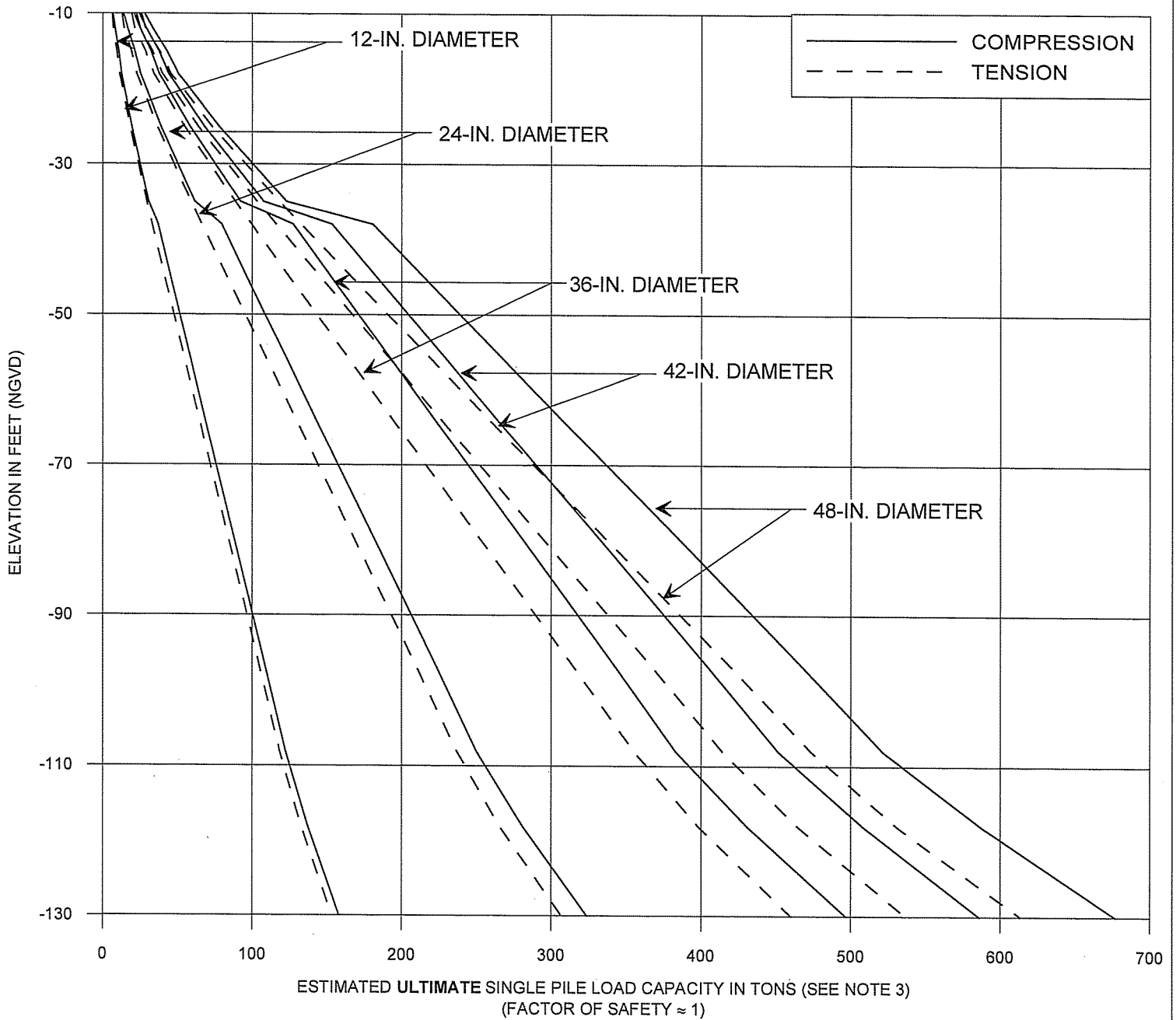

NOTES:

- 1) PILES ARE ASSUMED TO BE INSTALLED BY IMPACT DRIVING EQUIPMENT WITHOUT ASSISTANCE FROM JETTING, PREDRILLING, OR VIBRATORY EQUIPMENT.
- 2) THE PILE CAPACITIES DO NOT INCLUDE THE WEIGHT OF THE PILE.
- 3) A FACTOR OF SAFETY EQUAL TO 2 MAY BE USED IF STATIC PILE LOAD TESTING IS PERFORMED, AND A FACTOR OF SAFETY EQUAL TO 3 SHOULD BE USED IF STATIC TESTING IS NOT PERFORMED.

	EUSTIS ENGINEERING SERVICES, L.L.C. GEOTECHNICAL ENGINEERS 3011 28TH STREET METAIRIE, LOUISIANA	
ESTIMATED ULTIMATE SINGLE PILE LOAD CAPACITIES 12 TO 48-IN. OPEN END STEEL PIPE PILES-Q-CASE		
ST. MARY PARISH LEVEE DISTRICT FLOODGATE STRUCTURE AT FRANKLIN DRAINAGE CANAL ST. MARY PARISH, LOUISIANA		
DRAWN BY: D.J.I.	5 NOVEMBER 2009	FILE: OSP.GRF
CHECKED BY: J.J.H.	JOB NO.: 20749	FIGURE 6

Load Capacity of Rows or Groups of Driven Piles

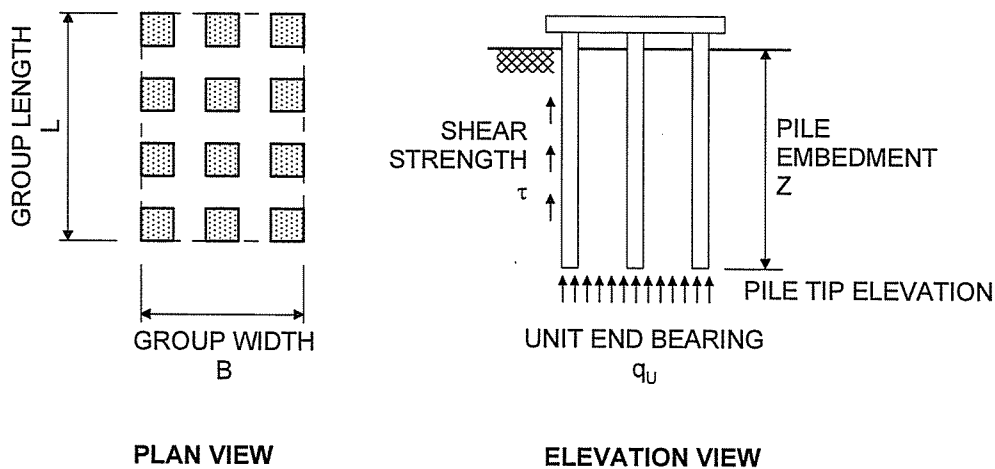

The capacity of a row or group of piles may be equal to or less than the sum of the individual load capacities of piles within the group. The pile row or group may be considered a single equivalent pier, in which case the row or group capacity may be investigated using the following formula.

$$P_{\text{GROUP}} = \frac{(2L + 2B)(\tau)(z)}{FS_{\text{SIDE}}} + \frac{(B)(L)(q_u)}{FS_{\text{BASE}}}$$

- where:
- B = The width of the pile group in plan dimension,
 - L = The length of the pile group in plan dimension,
 - Z = The embedded pile length,
 - τ = The average unit shear strength acting on the embedded pile length,
 - q_u = The ultimate unit end-bearing pressure appropriate for the pile group,
 - FS_{SIDE} = A factor of safety against mobilization of the ultimate skin friction, typically 2, and
 - FS_{BASE} = A factor of safety against mobilization of the ultimate end bearing, usually at least 3.

Notes:

- (1) The average unit shear strength acting on the embedded pile length may be taken as the weighted average value of undrained shear strength (or undrained cohesion) acting over that length for assessments of the short-term load capacity of the group.
- (2) For assessments of the short-term load capacity of the group, the ultimate end bearing is commonly estimated by multiplying an undrained shear strength (or undrained cohesion) by a bearing capacity factor, which typically varies between 5 and 6. The appropriate undrained shear strength and bearing capacity factor should consider the width and length of the pile group and the presence of any weak strata beneath the pile tips. In general, the unit end bearing pressure applicable to the pile group is not the same as the unit end bearing pressure used to estimate the load capacity of a single pile.
- (3) The factor of safety against base failure should consider that large deformations may be required to mobilize the ultimate end bearing soil pressure estimated for the pile group.

Spacing of Pile Groups and Spacing of Piles Within Rows or Groups

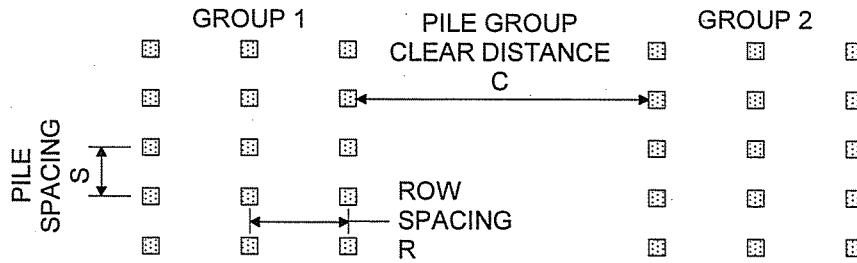

Piles should be arranged to provide a minimum center-to-center spacing, S, within rows or groups. This minimum recommended spacing may be taken as the largest value from the following criteria:

$$S = \frac{L_1}{20} + \frac{L_2}{40} + \frac{L_3}{80}, \text{ or}$$

$$S = 3B, \text{ or}$$

$$S = 3 \text{ feet}$$

- where
- S = Center-to-center pile spacing, as illustrated above,
 - L₁ = Pile embedment up to 100 feet,
 - L₂ = Pile embedment between 100 and 200 feet,
 - L₃ = Pile embedment between 200 and 300 feet, and
 - B = Pile outside diameter or side dimension

These criteria can be presented graphically as follows:

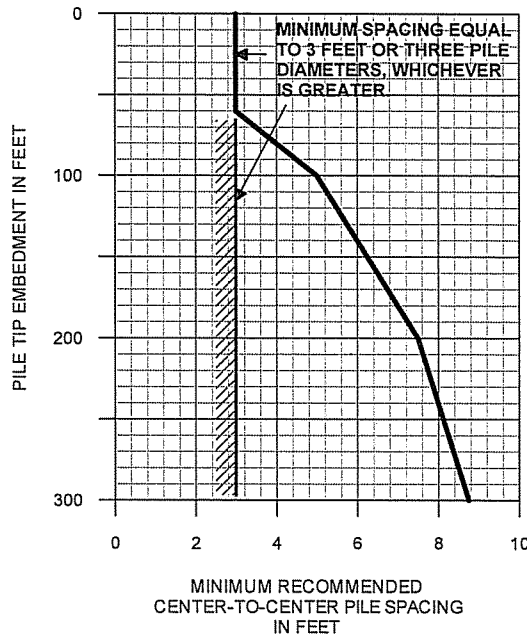

In addition, rows of single piles should provide a minimum center to center spacing, R, that is at least as large as the center-to-center pile spacing, S. Finally, individual pile groups should be arranged to provide a clear group spacing, C, equal to twice the largest dimension of the larger pile group. It should be noted that pile spacings greater than the minimum values presented above may be required to minimize the influence of individual piles on each other with respect to lateral load resistance and settlement or to ensure pile group capacity is adequate when investigated for group perimeter shear.



**AXIAL AND HORIZONTAL RESISTANCE OF BATTER PILES
ESTIMATED FROM ALLOWABLE VERTICAL LOAD CAPACITIES**

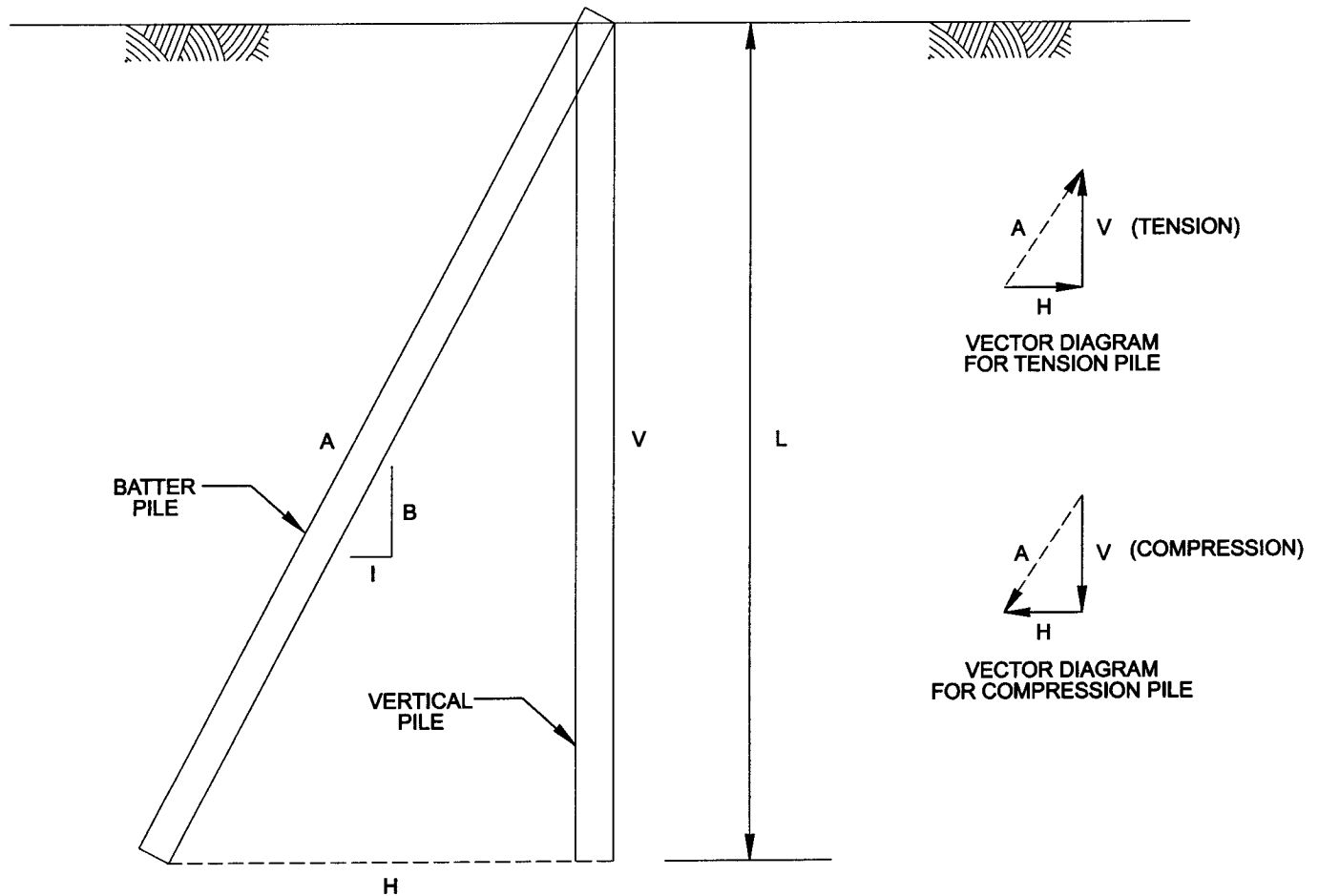

L = VERTICAL COMPONENT OF BATTER PILE EMBEDMENT LENGTH.

V = ESTIMATED ALLOWABLE SINGLE PILE LOAD CAPACITY OF A PILE DRIVEN VERTICALLY WITH EMBEDMENT LENGTH, L.

B = BATTER OF PILE EXPRESSED AS A RATIO OF VERTICAL DISTANCE TO ONE FOOT HORIZONTAL DISTANCE.

H = HORIZONTAL RESISTANCE OF BATTER PILE ESTIMATED AS FOLLOWS: $H = \frac{V}{B}$

A = ALLOWABLE AXIAL PILE LOAD CAPACITY OF A SINGLE BATTER PILE ESTIMATED AS FOLLOWS: $A = \sqrt{V^2(1 + \frac{1}{B^2})}$

NOTE: THE AXIAL LOAD RESISTANCE OF A VERTICAL PILE, V, IS DEPENDENT ON THE TYPE OF LOADING - TENSION OR COMPRESSION. CAUTION SHOULD BE EXERCISED TO ENSURE THAT THE CORRECT VERTICAL CAPACITY IS USED.

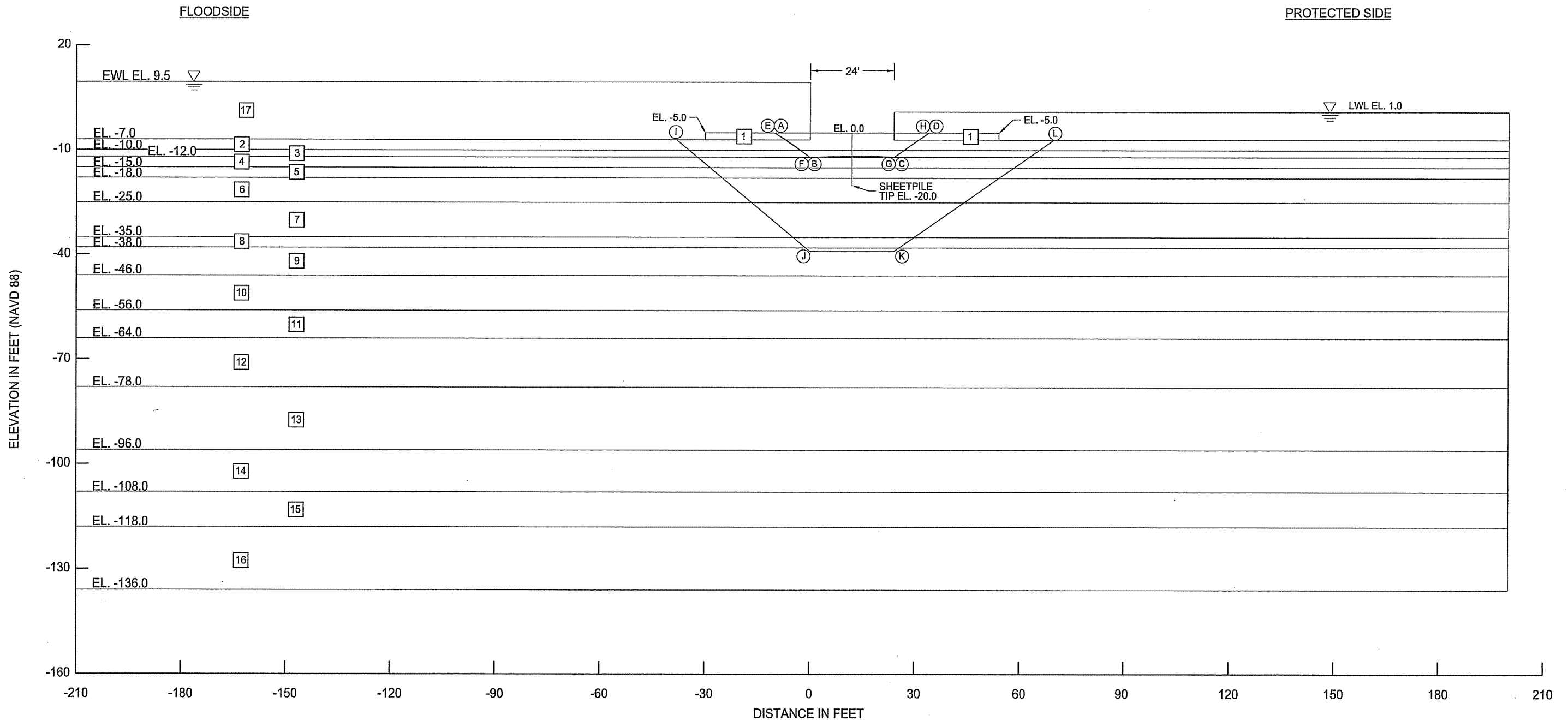

SOIL NO.	DESCRIPTION	FRICTION ANGLE IN DEGREES	UNIT WEIGHT IN PCF	COHESION IN PSF	
				AVG	BASE
1	RIPRAP	40	132	0	0
2	CLAY	0	120	300	300
3	SILT	15	117	200	200
4	CLAY	0	125	500	500
5	CLAY	0	120	400	400
6	CLAY	0	112	600	775
7	CLAY	0	122	775	1025
8	CLAY	0	122	1025	1100
9	CLAY	0	125	1100	1100
10	CLAY	0	122	1325	1325
11	CLAY	0	126	1450	1450
12	CLAY	0	118	1130	1130
13	CLAY	0	115	1130	1130
14	CLAY	0	124	1825	1825
15	CLAY	0	121	2200	2200
16	CLAY	0	115	1525	1525
17	WATER	0	62.4	0	0

TANGENT ELEVATION OF SLIP SURFACE	POINT	DEFINED FAILURE SURFACE		COMPUTED FACTOR OF SAFETY	TARGET FACTOR OF SAFETY	COMPUTER FILE
		X-COORDINATE	Y-COORDINATE			
-12.0	(A)	-10.3	-5.0	4.13	1.40	BARGE GATE (EWL OPTIMIZED FULLY SPECIFID).GSZ
	(B)	0.0	-12.0			
	(C)	24.0	-12.0			
	(D)	34.0	-5.0			
-12.0	(E)	-10.0	-5.0	4.16	1.40	BARGE GATE (EWL UPPER BLOCK).GSZ
	(F)	0.0	-12.0			
	(G)	24.0	-12.0			
	(H)	34.0	-5.0			
-39.0	(I)	-38.1	-7.0	7.78	1.40	BARGE GATE (EWL LOWER BLOCK).GSZ
	(J)	0.0	-39.0			
	(K)	24.0	-39.0			
	(L)	69.7	-7.0			

NOTES:

- SLOPE STABILITY ANALYSIS PERFORMED USING SPENCER'S METHOD AND THE OPTIMIZATION SEARCH ROUTINE WITH SLOPE/W SOFTWARE VERSION 7.15.
- SHEETPILE TIP ELEVATION WAS ESTABLISHED USING METHODS DEFINED IN THE USACE'S "HURRICANE AND STORM DRAINAGE REDUCTION SYSTEM DESIGN GUIDELINES."
- COMPUTED FACTORS OF SAFETY EXCEEDED THE TARGET FACTOR OF SAFETY WITHOUT THE NEED FOR STABILIZING UNBALANCED LOADS. THEREFORE, CONTRIBUTION TO AXIAL CAPACITY CAN BE CONSIDERED BELOW THE BOTTOM OF THE STRUCTURE.



EUSTIS ENGINEERING SERVICES, L.L.C.
 GEOTECHNICAL ENGINEERS
 3011 28TH STREET METAIRIE, LOUISIANA

**BARGE GATE STABILITY ANALYSIS
 EXTREME WATER LEVEL
 SPENCER'S METHOD**

**ST. MARY PARISH LEVEE DISTRICT
 FLOODGATE STRUCTURE AT
 FRANKLIN DRAINAGE CANAL
 ST. MARY PARISH, LOUISIANA**

DRAWN BY: J.L.S.	PLOT DATE: 20 JAN 10	CADD FILE: BARGE_EWL.DGN
CHECKED BY: M.K.M.	JOB NO.: 20749	FIGURE 10 SHEET 1

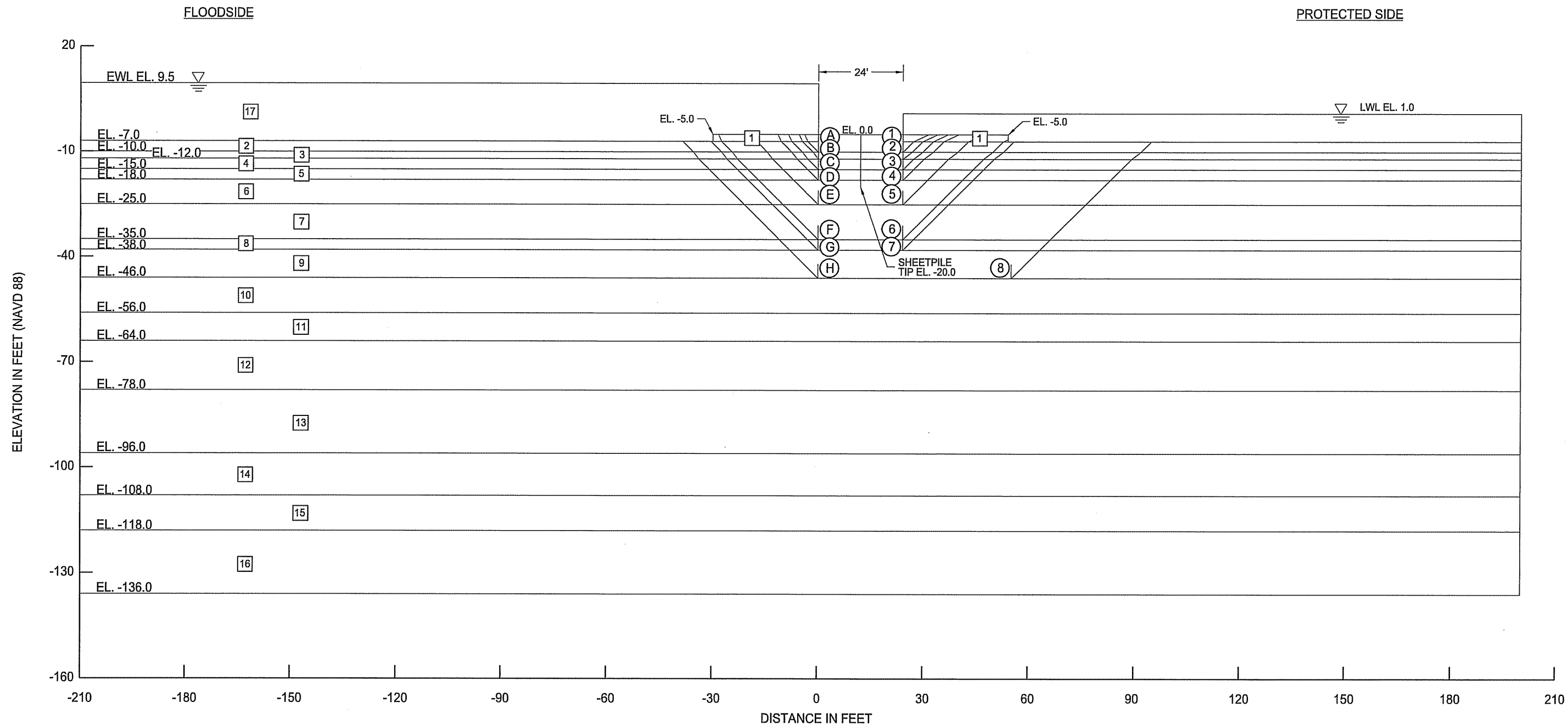

SOIL NO.	DESCRIPTION	FRICTION ANGLE IN DEGREES	UNIT WEIGHT IN PCF	COHESION IN PSF	
				AVG	BASE
1	RIPRAP	40	132	0	0
2	CLAY	0	120	300	300
3	SILT	15	117	200	200
4	CLAY	0	125	500	500
5	CLAY	0	120	400	400
6	CLAY	0	112	600	775
7	CLAY	0	122	775	1025
8	CLAY	0	122	1025	1100
9	CLAY	0	125	1100	1100
10	CLAY	0	122	1325	1325
11	CLAY	0	126	1450	1450
12	CLAY	0	118	1130	1130
13	CLAY	0	115	1130	1130
14	CLAY	0	124	1825	1825
15	CLAY	0	121	2200	2200
16	CLAY	0	115	1525	1525
17	WATER	0	62.4	0	0

SLIP SURFACE	SUMMATION OF FORCES IN KIPS/LF			FREE WATER KIPS/LF	UNBALANCED LOAD (F _{UB}) KIPS/LF
	RESISTING/1.2	DRIVING	DRIVING-RESISTING		
(A) ①	9.18	7.75	-1.43	5.61	-7.04
(B) ②	13.79	8.80	-4.99	5.61	-10.60
(C) ③	18.58	10.41	-8.17	5.61	-13.77
(D) ④	30.08	12.04	-18.04	5.61	-23.64
(E) ⑤	49.08	15.90	-33.18	5.61	-38.78
(F) ⑥	76.24	21.51	-54.74	5.61	-60.34
(G) ⑦	86.15	23.23	-62.92	5.61	-68.53
(H) ⑧	93.26	31.43	-61.83	5.61	-67.43
COMPUTER FILE		EWL			

NOTES:

- SLOPE STABILITY ANALYSIS PERFORMED USING L.M.V.D. METHOD OF PLANES.
- SHEETPILE TIP ELEVATION WAS ESTABLISHED USING METHODS DEFINED IN THE USACE'S "HURRICANE AND STORM DRAINAGE REDUCTION SYSTEM DESIGN GUIDELINES."
- THE UNBALANCED LOAD, F_{UB}, IS THE SUM OF THE DRIVING FORCES LESS THE SUM OF THE RESISTING FORCES (DIVIDED BY THE TARGET FACTOR OF SAFETY) AND LESS THE FREE WATER FORCE. RESISTING FORCES WERE REDUCED BY A FACTOR OF SAFETY OF 1.20.



EUSTIS ENGINEERING SERVICES, L.L.C.
 GEOTECHNICAL ENGINEERS
 3011 28TH STREET METAIRIE, LOUISIANA

**BARGE GATE STABILITY ANALYSIS
 EXTREME WATER LEVEL
 METHOD OF PLANES**

**ST. MARY PARISH LEVEE DISTRICT
 FLOODGATE STRUCTURE AT
 FRANKLIN DRAINAGE CANAL
 ST. MARY PARISH, LOUISIANA**

DRAWN BY: J.L.S.	PLOT DATE: 20 JAN 10	CADD FILE: BARGE_EWL_MOP.DGN
CHECKED BY: M.K.M.	JOB NO.: 20749	FIGURE 10 SHEET 2

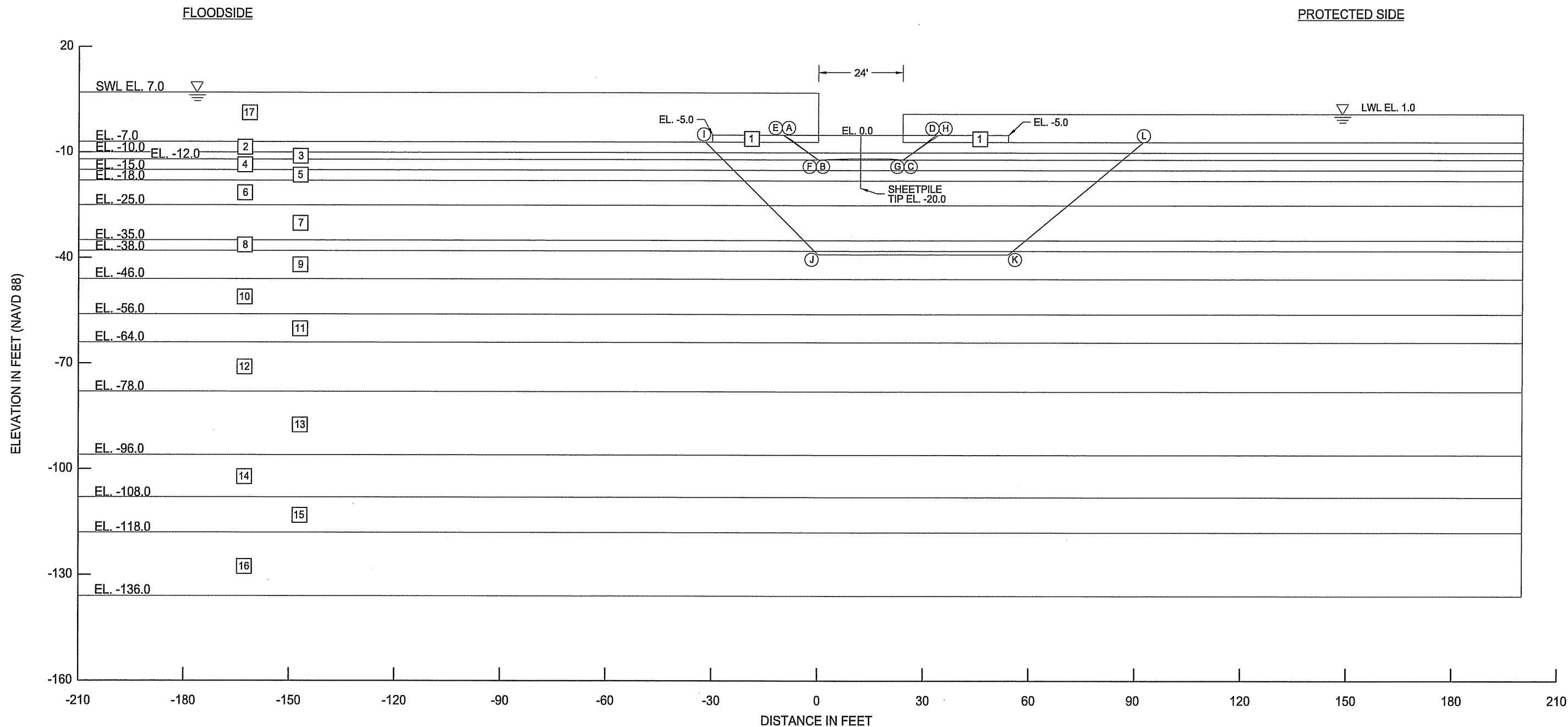

SOIL NO.	DESCRIPTION	FRICTION ANGLE IN DEGREES	UNIT WEIGHT IN PCF	COHESION IN PSF	
				AVG	BASE
1	RIPRAP	40	132	0	0
2	CLAY	0	120	300	300
3	SILT	15	117	200	200
4	CLAY	0	125	500	500
5	CLAY	0	120	400	400
6	CLAY	0	112	600	775
7	CLAY	0	122	775	1025
8	CLAY	0	122	1025	1100
9	CLAY	0	125	1100	1100
10	CLAY	0	122	1325	1325
11	CLAY	0	126	1450	1450
12	CLAY	0	118	1130	1130
13	CLAY	0	115	1130	1130
14	CLAY	0	124	1825	1825
15	CLAY	0	121	2200	2200
16	CLAY	0	115	1525	1525
17	WATER	0	62.4	0	0

TANGENT ELEVATION OF SLIP SURFACE	POINT	DEFINED FAILURE SURFACE		COMPUTED FACTOR OF SAFETY	TARGET FACTOR OF SAFETY	COMPUTER FILE
		X-COORDINATE	Y-COORDINATE			
-12.0	(A)	-9.8	-5.0	5.84	1.50	BARGE GATE (SWL OPTIMIZED FULLY SPECIFIED).GSZ
	(B)	0.0	-12.0			
	(C)	24.0	-12.0			
	(D)	33.3	-5.0			
-12.0	(E)	-10.0	-5.0	5.90	1.50	BARGE GATE (SWL UPPER BLOCK).GSZ
	(F)	0.0	-12.0			
	(G)	24.0	-12.0			
	(H)	34.0	-5.0			
-39.0	(I)	-32.0	-7.0	10.77	1.50	BARGE GATE (SWL LOWER BLOCK).GSZ
	(J)	0.0	-39.0			
	(K)	54.0	-39.0			
	(L)	92.1	-7.0			

NOTES:

- SLOPE STABILITY ANALYSIS PERFORMED USING SPENCER'S METHOD AND THE OPTIMIZATION SEARCH ROUTINE WITH SLOPE/W SOFTWARE VERSION 7.15.
- SHEETPILE TIP ELEVATION WAS ESTABLISHED USING METHODS DEFINED IN THE USACE'S "HURRICANE AND STORM DRAINAGE REDUCTION SYSTEM DESIGN GUIDELINES."
- COMPUTED FACTORS OF SAFETY EXCEEDED THE TARGET FACTOR OF SAFETY WITHOUT THE NEED FOR STABILIZING UNBALANCED LOADS. THEREFORE, CONTRIBUTION TO AXIAL CAPACITY CAN BE CONSIDERED BELOW THE BOTTOM OF THE STRUCTURE.

EUSTIS ENGINEERING SERVICES, L.L.C.
 GEOTECHNICAL ENGINEERS
 3011 28TH STREET METAIRIE, LOUISIANA

**BARGE GATE STABILITY ANALYSIS
 STILL WATER LEVEL
 SPENCER'S METHOD**

**ST. MARY PARISH LEVEE DISTRICT
 FLOODGATE STRUCTURE AT
 FRANKLIN DRAINAGE CANAL
 ST. MARY PARISH, LOUISIANA**

DRAWN BY: J.L.S.	PLOT DATE: 20 JAN 10	CADD FILE: BARGE_SWLDGN
CHECKED BY: M.K.M.	JOB NO.: 20749	FIGURE 10 SHEET 3

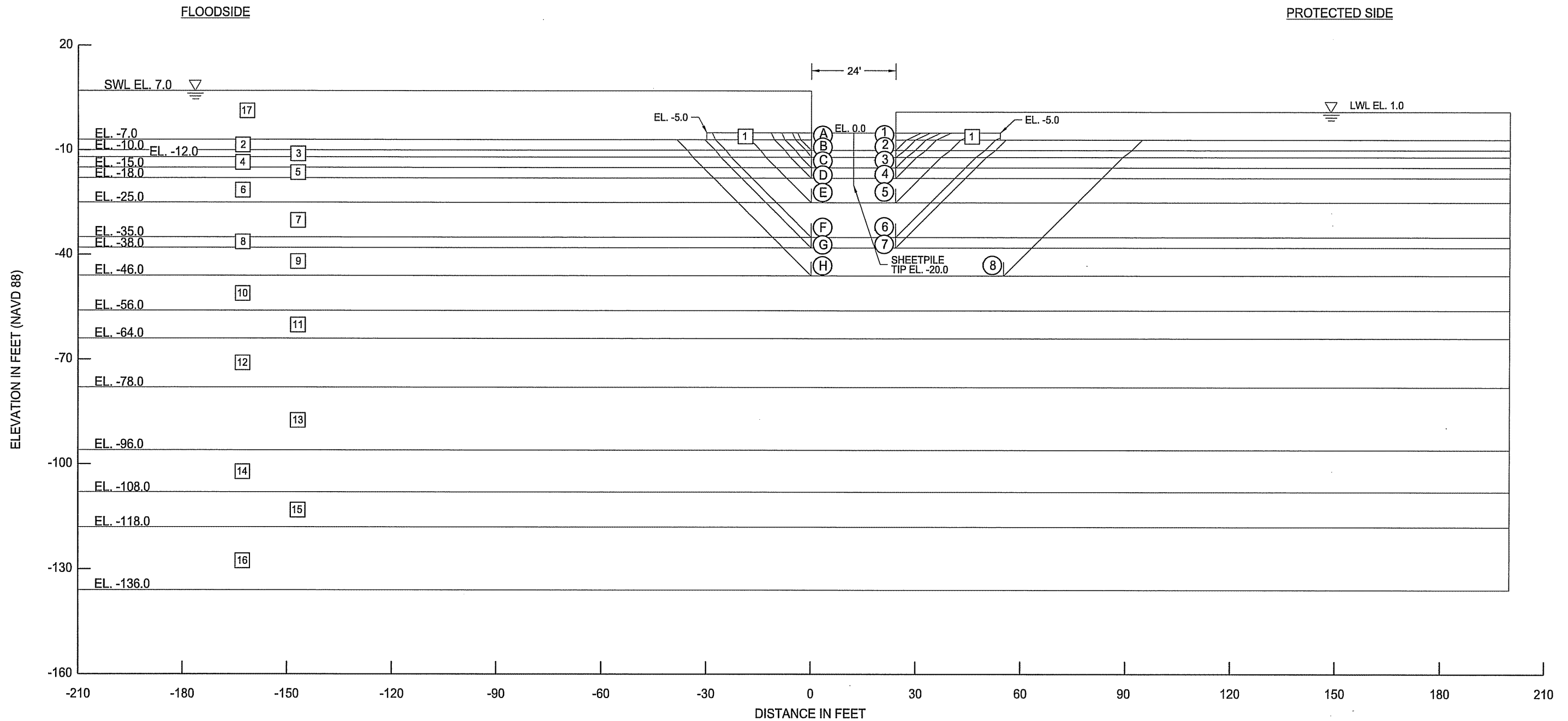

SOIL NO.	DESCRIPTION	FRICTION ANGLE IN DEGREES	UNIT WEIGHT IN PCF	COHESION IN PSF	
				AVG	BASE
1	RIPRAP	40	132	0	0
2	CLAY	0	120	300	300
3	SILT	15	117	200	200
4	CLAY	0	125	500	500
5	CLAY	0	120	400	400
6	CLAY	0	112	600	775
7	CLAY	0	122	775	1025
8	CLAY	0	122	1025	1100
9	CLAY	0	125	1100	1100
10	CLAY	0	122	1325	1325
11	CLAY	0	126	1450	1450
12	CLAY	0	118	1130	1130
13	CLAY	0	115	1130	1130
14	CLAY	0	124	1825	1825
15	CLAY	0	121	2200	2200
16	CLAY	0	115	1525	1525
17	WATER	0	62.4	0	0

SLIP SURFACE	SUMMATION OF FORCES IN KIPS/LF			FREE WATER KIPS/LF	UNBALANCED LOAD (F _{UB}) KIPS/LF
	RESISTING/1.30	DRIVING	DRIVING-RESISTING		
(A) ①	8.47	4.96	-3.51	3.49	-6.99
(B) ②	12.73	5.70	-7.04	3.49	-10.52
(C) ③	17.15	6.83	-10.32	3.49	-13.81
(D) ④	27.77	7.97	-19.80	3.49	-23.28
(E) ⑤	45.30	10.69	-34.61	3.49	-38.09
(F) ⑥	70.37	14.70	-55.67	3.49	-59.16
(G) ⑦	79.52	15.94	-63.58	3.49	-67.07
(H) ⑧	86.08	22.86	-63.22	3.49	-66.71
COMPUTER FILE		SWL			

NOTES:

- SLOPE STABILITY ANALYSIS PERFORMED USING L.M.V.D. METHOD OF PLANES.
- SHEETPILE TIP ELEVATION WAS ESTABLISHED USING METHODS DEFINED IN THE USACE'S "HURRICANE AND STORM DRAINAGE REDUCTION SYSTEM DESIGN GUIDELINES."
- THE UNBALANCED LOAD, F_{UB}, IS THE SUM OF THE DRIVING FORCES LESS THE SUM OF THE RESISTING FORCES (DIVIDED BY THE TARGET FACTOR OF SAFETY) AND LESS THE FREE WATER FORCE. RESISTING FORCES WERE REDUCED BY A FACTOR OF SAFETY OF 1.30.



EUSTIS ENGINEERING SERVICES, L.L.C.
 GEOTECHNICAL ENGINEERS
 3011 28TH STREET METAIRIE, LOUISIANA

**BARGE GATE STABILITY ANALYSIS
 STILL WATER LEVEL
 METHOD OF PLANES**

**ST. MARY PARISH LEVEE DISTRICT
 FLOODGATE STRUCTURE AT
 FRANKLIN DRAINAGE CANAL
 ST. MARY PARISH, LOUISIANA**

DRAWN BY: J.L.S.	PLOT DATE: 20 JAN 10	CADD FILE: BARGE_SWL_MOP.DGN
CHECKED BY: M.K.M.	JOB NO.: 20749	FIGURE 10 SHEET 4

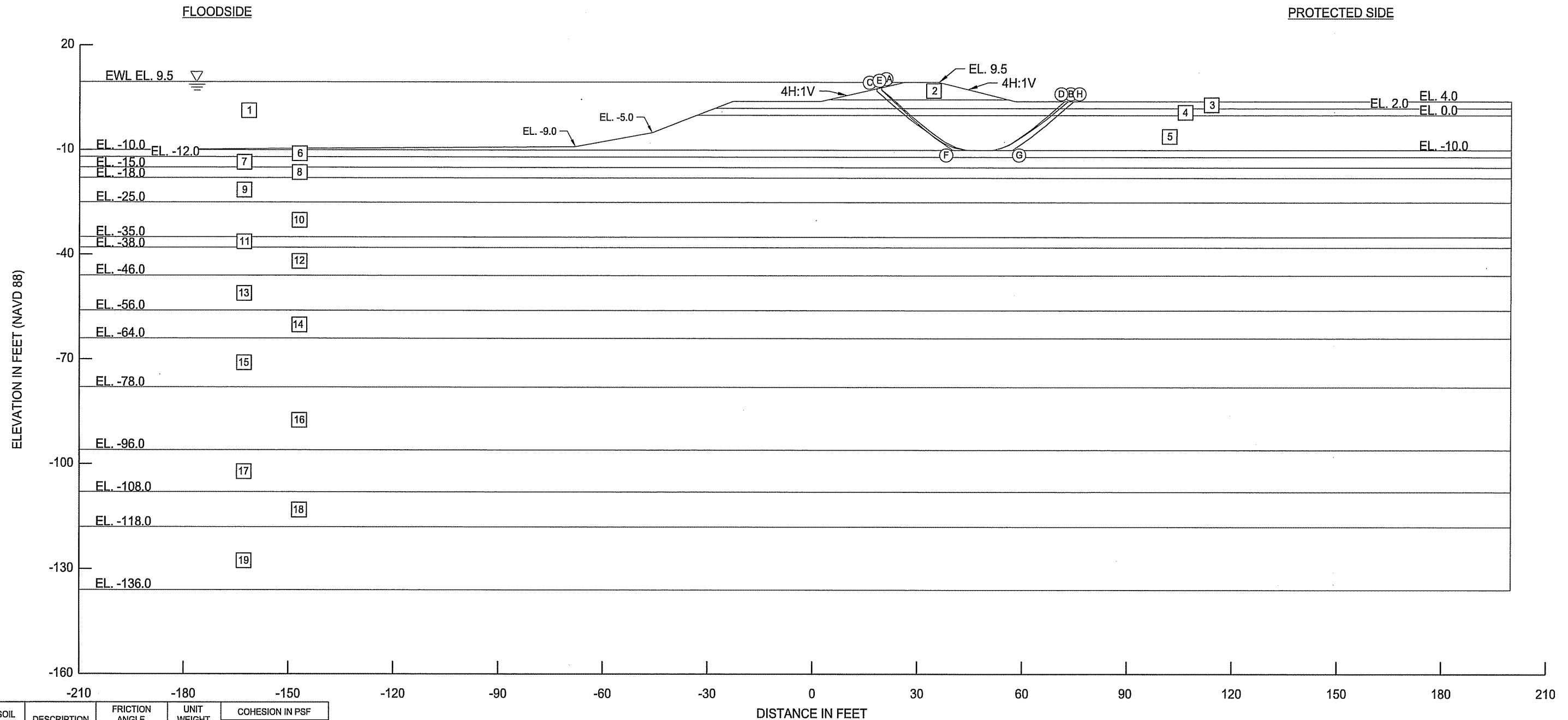

SOIL NO.	DESCRIPTION	FRICTION ANGLE IN DEGREES	UNIT WEIGHT IN PCF	COHESION IN PSF	
				AVG	BASE
1	WATER	0	62.4	0	0
2	COMPACTED CLAY	0	110	400	400
3	SILT	15	117	200	200
4	CLAY	0	120	400	400
5	CLAY	0	120	300	300
6	SILT	15	117	200	200
7	CLAY	0	125	500	500
8	CLAY	0	120	400	400
9	CLAY	0	112	600	775
10	CLAY	0	122	775	1025
11	CLAY	0	122	1025	1100
12	CLAY	0	125	1100	1100
13	CLAY	0	122	1325	1325
14	CLAY	0	126	1450	1450
15	CLAY	0	118	1130	1130
16	CLAY	0	115	1130	1130
17	CLAY	0	124	1825	1825
18	CLAY	0	121	2200	2200
19	CLAY	0	115	1525	1525

TANGENT ELEVATION OF SLIP SURFACE	POINT	DEFINED FAILURE SURFACE		COMPUTED FACTOR OF SAFETY	TARGET FACTOR OF SAFETY	COMPUTER FILE
		X-COORDINATE	Y-COORDINATE			
-10.0	(A)	19.6	8.0	2.79	1.40	LEVEE MKM (EWL BLOCK WITHOUT PASSIVE MODE W/ TENSION CRACK OPTIMIZED).GSZ
	(B)	72.9	4.0			
-10.0	(C)	18.2	7.7	2.79	1.40	LEVEE MKM EWL ENTRY AND EXIT WITHOUT PASSIVE MODE W/ TENSION CRACK OPTIMIZED).GSZ
	(D)	71.8	4.0			
-10.0	(E)	19.5	8.0	2.88	1.40	LEVEE MKM (EWL BLOCK WITHOUT PASSIVE MODE W/ TENSION CRACK FULLY SPECIFIED).GSZ
	(F)	40.0	-10.0			
	(G)	57.0	-10.0			
	(H)	74.5	4.0			

NOTE:
1. SLOPE STABILITY ANALYSIS PERFORMED USING SPENCER'S METHOD AND THE OPTIMIZATION SEARCH ROUTINE WITH SLOPEW SOFTWARE VERSION 7.15.

EUSTIS ENGINEERING SERVICES, L.L.C.
 GEOTECHNICAL ENGINEERS
 3011 28TH STREET METAIRIE, LOUISIANA

**LEVEE STABILITY ANALYSIS
 EXTREME WATER LEVEL
 SPENCER'S METHOD**

**ST. MARY PARISH LEVEE DISTRICT
 FLOODGATE STRUCTURE AT
 FRANKLIN DRAINAGE CANAL
 ST. MARY PARISH, LOUISIANA**

DRAWN BY: J.L.S.	PLOT DATE: 20 JAN 10	CADD FILE: LEVEE_EWL.DGN
CHECKED BY: M.K.M.	JOB NO.: 20749	FIGURE 11 SHEET 1

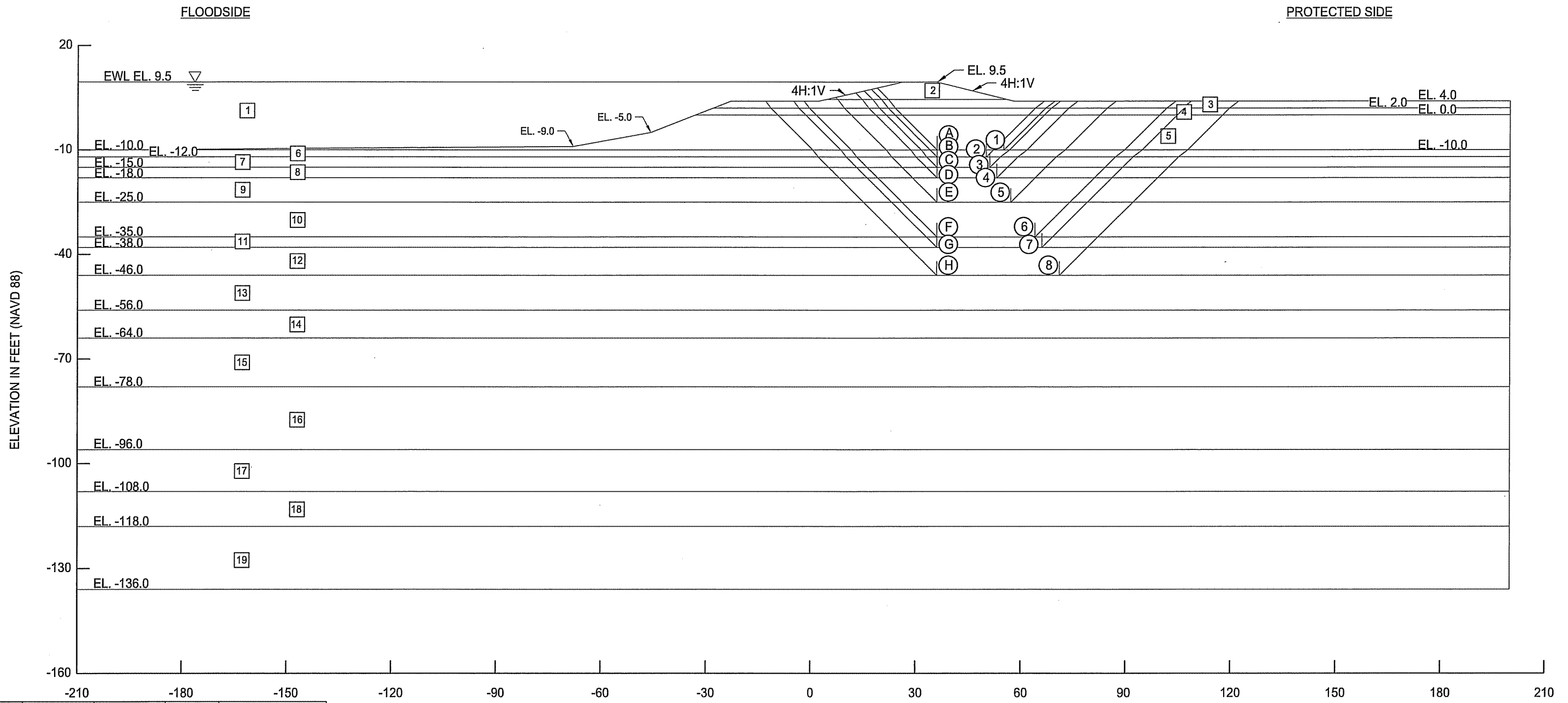

SOIL NO.	DESCRIPTION	FRICTION ANGLE IN DEGREES	UNIT WEIGHT IN PCF	COHESION IN PSF	
				AVG	BASE
1	WATER	0	62.4	0	0
2	COMPACTED CLAY	0	110	400	400
3	SILT	15	117	200	200
4	CLAY	0	120	400	400
5	CLAY	0	120	300	300
6	SILT	15	117	200	200
7	CLAY	0	125	500	500
8	CLAY	0	120	400	400
9	CLAY	0	112	600	775
10	CLAY	0	122	775	1025
11	CLAY	0	122	1025	1100
12	CLAY	0	125	1100	1100
13	CLAY	0	122	1325	1325
14	CLAY	0	126	1450	1450
15	CLAY	0	118	1130	1130
16	CLAY	0	115	1130	1130
17	CLAY	0	124	1825	1825
18	CLAY	0	121	2200	2200
19	CLAY	0	115	1525	1525

SLIP SURFACE	SUMMATION OF FORCES IN KIPS/LF			FACTOR OF SAFETY
	RESISTING/1.20	DRIVING	DRIVING-RESISTING	
(A) ①	21.44	9.69	-11.75	2.66
(B) ②	25.43	10.11	-15.32	3.02
(C) ③	29.26	11.75	-17.51	2.99
(D) ④	33.49	13.46	-20.03	2.99
(E) ⑤	54.43	16.80	-37.63	3.89
(F) ⑥	89.94	20.42	-69.53	5.29
(G) ⑦	103.76	21.46	-82.30	5.80
(H) ⑧	137.62	24.24	-113.38	6.81
COMPUTER FILE		EWL		

NOTES:
 1. SLOPE STABILITY ANALYSIS PERFORMED USING L.M.V.D. METHOD OF PLANES.
 2. FACTOR OF SAFETY IS THE SUM OF RESISTING FORCES DIVIDED BY THE SUM OF DRIVING FORCES.



EUSTIS ENGINEERING SERVICES, L.L.C.
 GEOTECHNICAL ENGINEERS
 3011 28TH STREET METAIRIE, LOUISIANA

LEVEE STABILITY ANALYSIS
 EXTREME WATER LEVEL
 METHOD OF PLANES

ST. MARY PARISH LEVEE DISTRICT
 FLOODGATE STRUCTURE AT
 FRANKLIN DRAINAGE CANAL
 ST. MARY PARISH, LOUISIANA

DRAWN BY: J.L.S.	PLOT DATE: 20 JAN 10	CADD FILE: LEVEE_EWL_MOP.DGN
CHECKED BY: M.K.M.	JOB NO.: 20749	FIGURE 11 SHEET 2

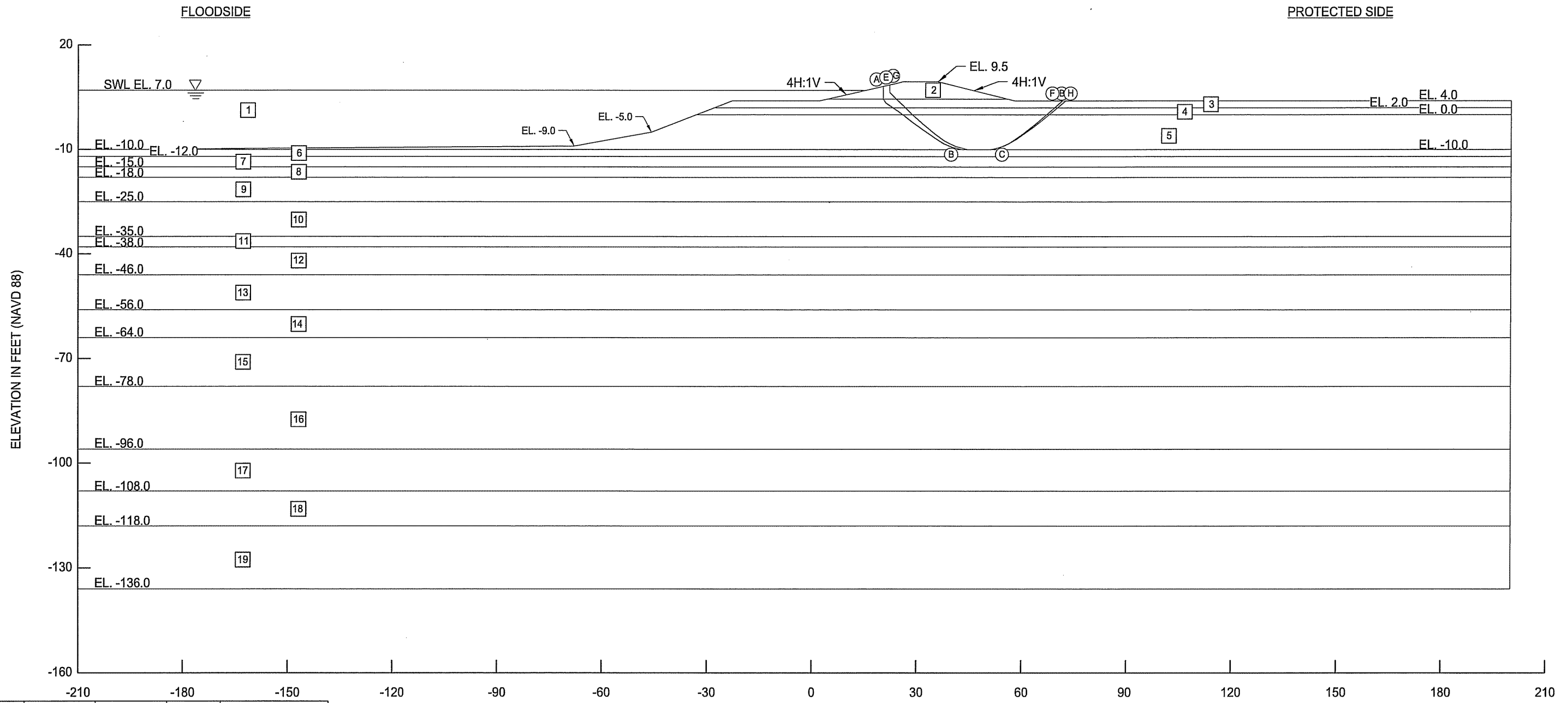

SOIL NO.	DESCRIPTION	FRICTION ANGLE IN DEGREES	UNIT WEIGHT IN PCF	COHESION IN PSF	
				AVG	BASE
1	WATER	0	62.4	0	0
2	COMPACTED CLAY	0	110	400	400
3	SILT	15	117	200	200
4	CLAY	0	120	400	400
5	CLAY	0	120	300	300
6	SILT	15	117	200	200
7	CLAY	0	125	500	500
8	CLAY	0	120	400	400
9	CLAY	0	112	600	775
10	CLAY	0	122	775	1025
11	CLAY	0	122	1025	1100
12	CLAY	0	125	1100	1100
13	CLAY	0	122	1325	1325
14	CLAY	0	126	1450	1450
15	CLAY	0	118	1130	1130
16	CLAY	0	115	1130	1130
17	CLAY	0	124	1825	1825
18	CLAY	0	121	2200	2200
19	CLAY	0	115	1525	1525

TANGENT ELEVATION OF SLIP SURFACE	POINT	DEFINED FAILURE SURFACE		COMPUTED FACTOR OF SAFETY	TARGET FACTOR OF SAFETY	COMPUTER FILE
		X-COORDINATE	Y-COORDINATE			
18.0	(A)	-61.4	-7.8	2.07	1.40	LEVEE MKM (SWL BLOCK WITHOUT PASSIVE MODE FULLY SPECIFIED).GSZ
	(B)	38.6	8.8			
	(C)	-46.0	-5.0			
	(D)	37.8	9.1			
-10.0	(E)	-48.5	-5.5	2.08	1.40	LEVEE MKM (EWL BLOCK WITHOUT PASSIVE MODE OPTIMIZED).GSZ
	(F)	-42.0	-10.0			
-10.0	(G)	21.0	-10.0	2.16	1.40	LEVEE MKM (EWL ENTRY AND EXIT WITHOUT PASSIVE MODE OPTIMIZED).GSZ
	(H)	36.3	9.4			

NOTE:
1. SLOPE STABILITY ANALYSIS PERFORMED USING SPENCER'S METHOD AND THE OPTIMIZATION SEARCH ROUTINE WITH SLOPE/W SOFTWARE VERSION 7.15.

EUSTIS ENGINEERING SERVICES, L.L.C.
 GEOTECHNICAL ENGINEERS
 3011 28TH STREET METAIRIE, LOUISIANA

**LEVEE STABILITY ANALYSIS
 STILL WATER LEVEL
 SPENCER'S METHOD**

**ST. MARY PARISH LEVEE DISTRICT
 FLOODGATE STRUCTURE AT
 FRANKLIN DRAINAGE CANAL
 ST. MARY PARISH, LOUISIANA**

DRAWN BY: J.L.S.	PLOT DATE: 20 JAN 10	CADD FILE: LEVEE_SWL.DGN
CHECKED BY: M.K.M.	JOB NO.: 20749	FIGURE 11 SHEET 3

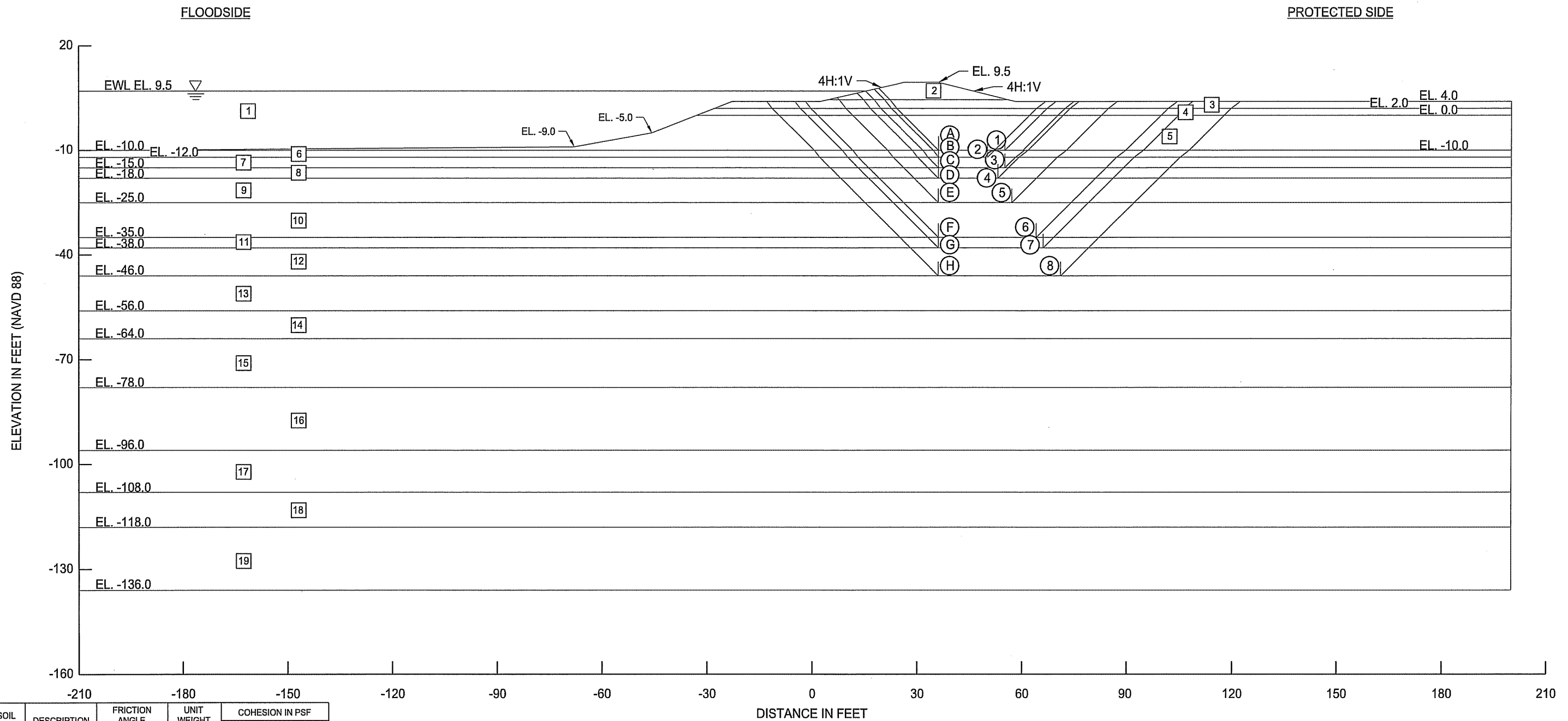

SOIL NO.	DESCRIPTION	FRICTION ANGLE IN DEGREES	UNIT WEIGHT IN PCF	COHESION IN PSF	
				AVG	BASE
1	WATER	0	62.4	0	0
2	COMPACTED CLAY	0	110	400	400
3	SILT	15	117	200	200
4	CLAY	0	120	400	400
5	CLAY	0	120	300	300
6	SILT	15	117	200	200
7	CLAY	0	125	500	500
8	CLAY	0	120	400	400
9	CLAY	0	112	600	775
10	CLAY	0	122	775	1025
11	CLAY	0	122	1025	1100
12	CLAY	0	125	1100	1100
13	CLAY	0	122	1325	1325
14	CLAY	0	126	1450	1450
15	CLAY	0	118	1130	1130
16	CLAY	0	115	1130	1130
17	CLAY	0	124	1825	1825
18	CLAY	0	121	2200	2200
19	CLAY	0	115	1525	1525

SLIP SURFACE	SUMMATION OF FORCES IN KIPS/LF			FACTOR OF SAFETY
	RESISTING/1.30	DRIVING	DRIVING-RESISTING	
(A) ①	19.79	9.19	-10.60	2.80
(B) ②	23.47	9.42	-14.06	3.24
(C) ③	28.20	11.11	-17.09	3.30
(D) ④	30.91	11.80	-19.11	3.40
(E) ⑤	50.24	13.99	-36.25	4.67
(F) ⑥	83.02	15.96	-67.06	6.76
(G) ⑦	95.77	16.52	-79.25	7.54
(H) ⑧	127.03	18.02	-109.00	9.16
COMPUTER FILE		SWL		

NOTES:
 1. SLOPE STABILITY ANALYSIS PERFORMED USING L.M.V.D. METHOD OF PLANES.
 2. FACTOR OF SAFETY IS THE SUM OF RESISTING FORCES DIVIDED BY THE SUM OF DRIVING FORCES.

EUSTIS ENGINEERING SERVICES, L.L.C.
 GEOTECHNICAL ENGINEERS
 3011 28TH STREET METAIRIE, LOUISIANA

**LEVEE STABILITY ANALYSIS
 STILL WATER LEVEL
 METHOD OF PLANES**

**ST. MARY PARISH LEVEE DISTRICT
 FLOODGATE STRUCTURE AT
 FRANKLIN DRAINAGE CANAL
 ST. MARY PARISH, LOUISIANA**

DRAWN BY: J.L.S.	PLOT DATE: 20 JAN 10	CADD FILE: LEVEE_SWL_MOP.DGN
CHECKED BY: M.K.M.	JOB NO.: 20749	FIGURE 11 SHEET 4

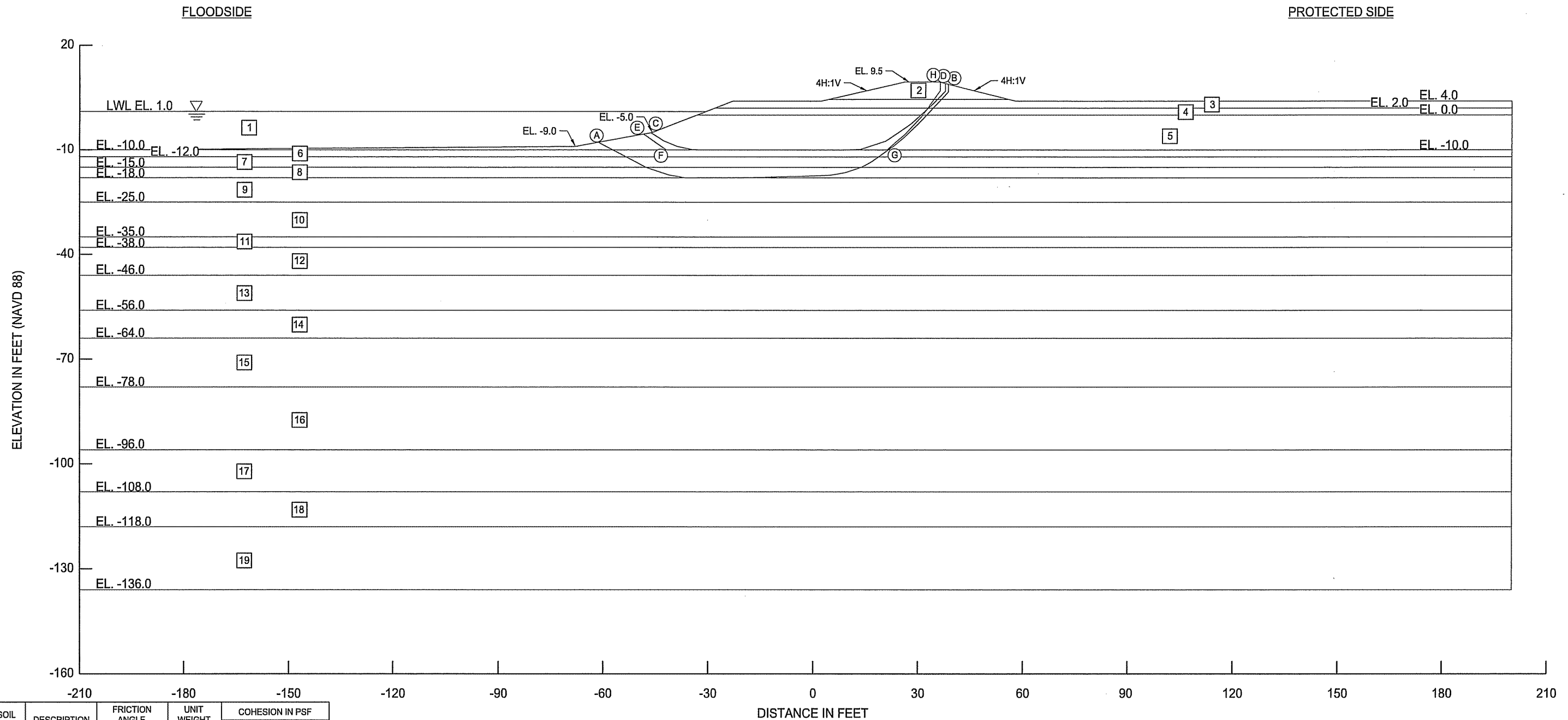

SOIL NO.	DESCRIPTION	FRICTION ANGLE IN DEGREES	UNIT WEIGHT IN PCF	COHESION IN PSF	
				AVG	BASE
1	WATER	0	62.4	0	0
2	COMPACTED CLAY	0	110	400	400
3	SILT	15	117	200	200
4	CLAY	0	120	400	400
5	CLAY	0	120	300	300
6	SILT	15	117	200	200
7	CLAY	0	125	500	500
8	CLAY	0	120	400	400
9	CLAY	0	112	600	775
10	CLAY	0	122	775	1025
11	CLAY	0	122	1025	1100
12	CLAY	0	125	1100	1100
13	CLAY	0	122	1325	1325
14	CLAY	0	126	1450	1450
15	CLAY	0	118	1130	1130
16	CLAY	0	115	1130	1130
17	CLAY	0	124	1825	1825
18	CLAY	0	121	2200	2200
19	CLAY	0	115	1525	1525

TANGENT ELEVATION OF SLIP SURFACE	POINT	DEFINED FAILURE SURFACE		COMPUTED FACTOR OF SAFETY	TARGET FACTOR OF SAFETY	COMPUTER FILE
		X-COORDINATE	Y-COORDINATE			
-10.0	(A)	-61.4	-7.8	2.07	1.40	LEVEE MKM (LWL ENTRY AND EXIT WITHOUT PASSIVE MODE W/ TENSION CRACK OPTIMIZED).GSZ
	(B)	38.6	8.8			
-10.0	(C)	-46.0	-5.0	2.08	1.40	LEVEE MKM (LWL BLOCK WITHOUT PASSIVE MODE W/ TENSION CRACK OPTIMIZED).GSZ
	(D)	37.8	9.1			
-10.0	(E)	-48.5	-5.5	2.16	1.40	LEVEE MKM (LWL BLOCK WITHOUT PASSIVE MODE W/ TENSION CRACK OPTIMIZED).GSZ
	(F)	-42.0	-10.0			
	(G)	21.0	-10.0			
	(H)	36.3	9.4			

NOTE:
1. SLOPE STABILITY ANALYSIS PERFORMED USING SPENCER'S METHOD AND THE OPTIMIZATION SEARCH ROUTINE WITH SLOPE/W SOFTWARE VERSION 7.15.



EUSTIS ENGINEERING SERVICES, L.L.C.
 GEOTECHNICAL ENGINEERS
 3011 28TH STREET METAIRIE, LOUISIANA

LEVEE STABILITY ANALYSIS
 LOW WATER LEVEL
 SPENCER'S METHOD

ST. MARY PARISH LEVEE DISTRICT
 FLOODGATE STRUCTURE AT
 FRANKLIN DRAINAGE CANAL
 ST. MARY PARISH, LOUISIANA

DRAWN BY: J.L.S.	PLOT DATE: 20 JAN 10	CADD FILE: LEVEE_LWL.DGN
CHECKED BY: M.K.M.	JOB NO.: 20749	FIGURE 11 SHEET 5

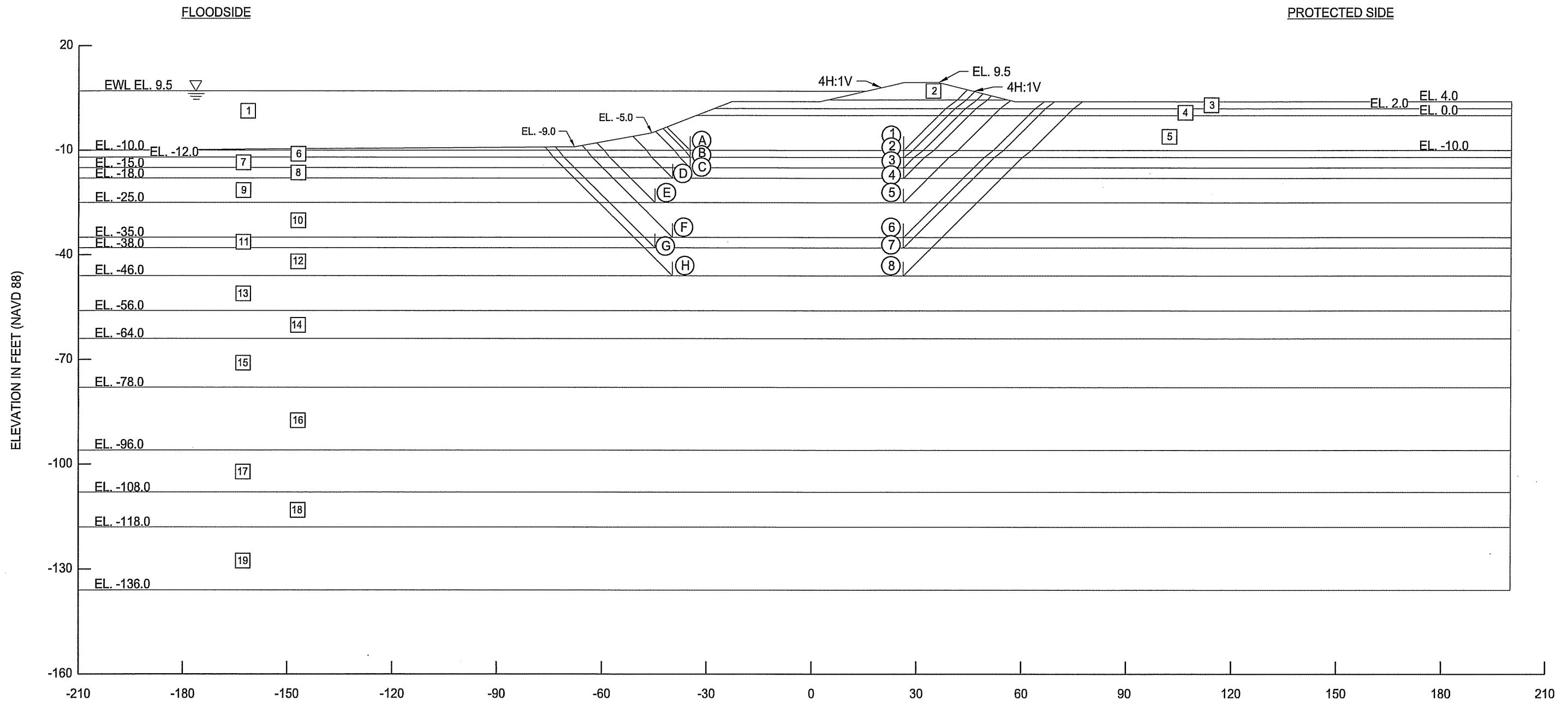

SOIL NO.	DESCRIPTION	FRICTION ANGLE IN DEGREES	UNIT WEIGHT IN PCF	COHESION IN PSF	
				AVG	BASE
1	WATER	0	62.4	0	0
2	COMPACTED CLAY	0	110	400	400
3	SILT	15	117	200	200
4	CLAY	0	120	400	400
5	CLAY	0	120	300	300
6	SILT	15	117	200	200
7	CLAY	0	125	500	500
8	CLAY	0	120	400	400
9	CLAY	0	112	600	775
10	CLAY	0	122	775	1025
11	CLAY	0	122	1025	1100
12	CLAY	0	125	1100	1100
13	CLAY	0	122	1325	1325
14	CLAY	0	126	1450	1450
15	CLAY	0	118	1130	1130
16	CLAY	0	115	1130	1130
17	CLAY	0	124	1825	1825
18	CLAY	0	121	2200	2200
19	CLAY	0	115	1525	1525

SLIP SURFACE	SUMMATION OF FORCES IN KIPS/LF			FACTOR OF SAFETY
	RESISTING/1.30	DRIVING	DRIVING-RESISTING	
(A) ①	25.79	15.33	-10.46	2.19
(B) ②	34.87	17.51	-17.36	2.59
(C) ③	36.29	20.44	-15.85	2.31
(D) ④	40.36	24.39	-15.97	2.15
(E) ⑤	73.36	31.96	-41.41	2.98
(F) ⑥	113.80	41.92	-71.88	3.53
(G) ⑦	123.40	43.57	-79.83	3.68
(H) ⑧	146.19	49.32	-96.87	3.85
COMPUTER FILE		LWL		

NOTES:
 1. SLOPE STABILITY ANALYSIS PERFORMED USING L.M.V.D. METHOD OF PLANES.
 2. FACTOR OF SAFETY IS THE SUM OF RESISTING FORCES DIVIDED BY THE SUM OF DRIVING FORCES.



EUSTIS ENGINEERING SERVICES, L.L.C.
 GEOTECHNICAL ENGINEERS
 3011 28TH STREET METAIRIE, LOUISIANA

LEVEE STABILITY ANALYSIS
 LOW WATER LEVEL
 METHOD OF PLANES

ST. MARY PARISH LEVEE DISTRICT
 FLOODGATE STRUCTURE AT
 FRANKLIN DRAINAGE CANAL
 ST. MARY PARISH, LOUISIANA

DRAWN BY: J.L.S.	PLOT DATE: 20 JAN 10	CADD FILE: LEVEE_LWL_MOP.DGN
CHECKED BY: M.K.M.	JOB NO.: 20749	FIGURE 11 SHEET 6

Fill and Pile Loads

Data Type: None

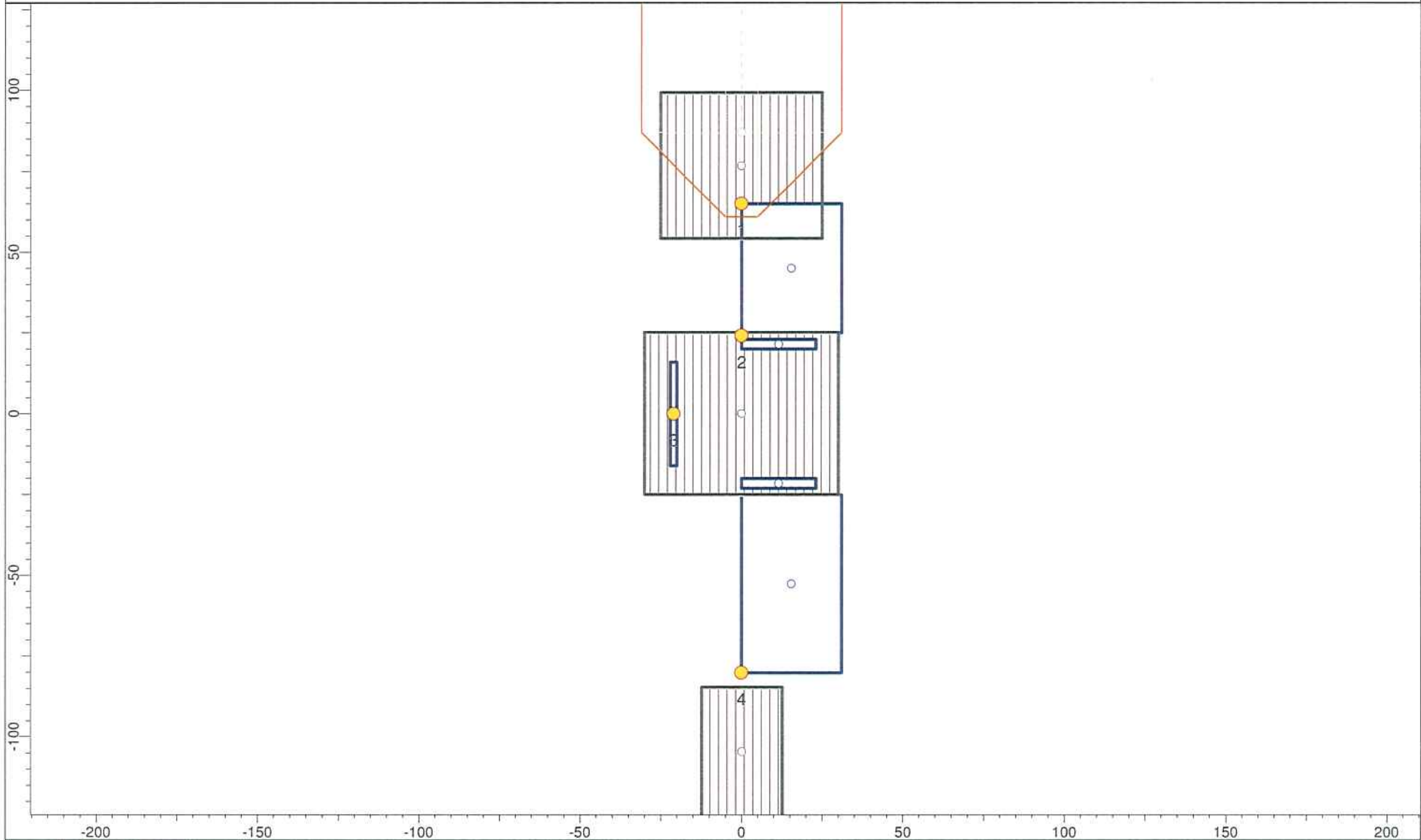

SETTLE3D 2.006

Project				St. Mary Parish Franklin Canal Floodgate Structure			
Analysis Description				Settlement Analysis			
Drawn By	MKM	Checked By	JJH	Company	Eustis		
Date	1/13/2010, 4:58:02 PM		File Name	Fill + Pile Loads.s3z		Figure 12 Sheet 1	

Total Settlement vs. Elevation

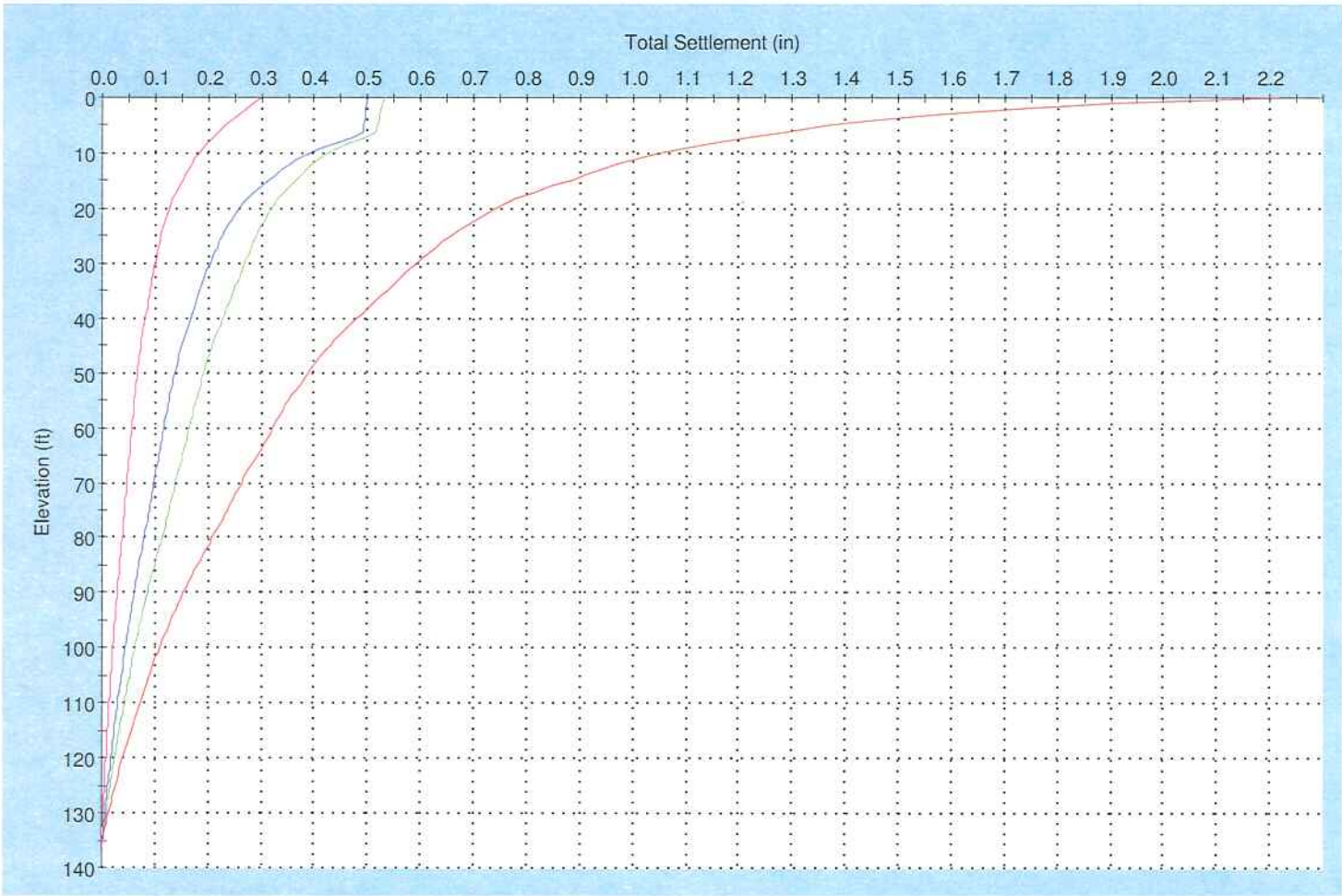

- Query Point 1 (Fill Loads)
- Query Point 2 (Fill Loads)
- Query Point 3 (Fill Loads)
- Query Point 4 (Fill Loads)

Reference Stage: None



SETTLE3D 2.006

<i>Project</i>				St. Mary Parish Franklin Canal Floodgate Structure	
<i>Analysis Description</i>				Settlement Analysis for Fill Loads Evaluated at 2/3 Depth of Pile Embedment	
<i>Drawn By</i>	MKM	<i>Checked By</i>	JJH	<i>Company</i>	Eustis
<i>Date</i>	1/13/2010, 4:58:02 PM		<i>File Name</i>	Fill + Pile Loads.s3z	Figure 12 Sheet 2

Data Type:

Total Settlement vs. Elevation

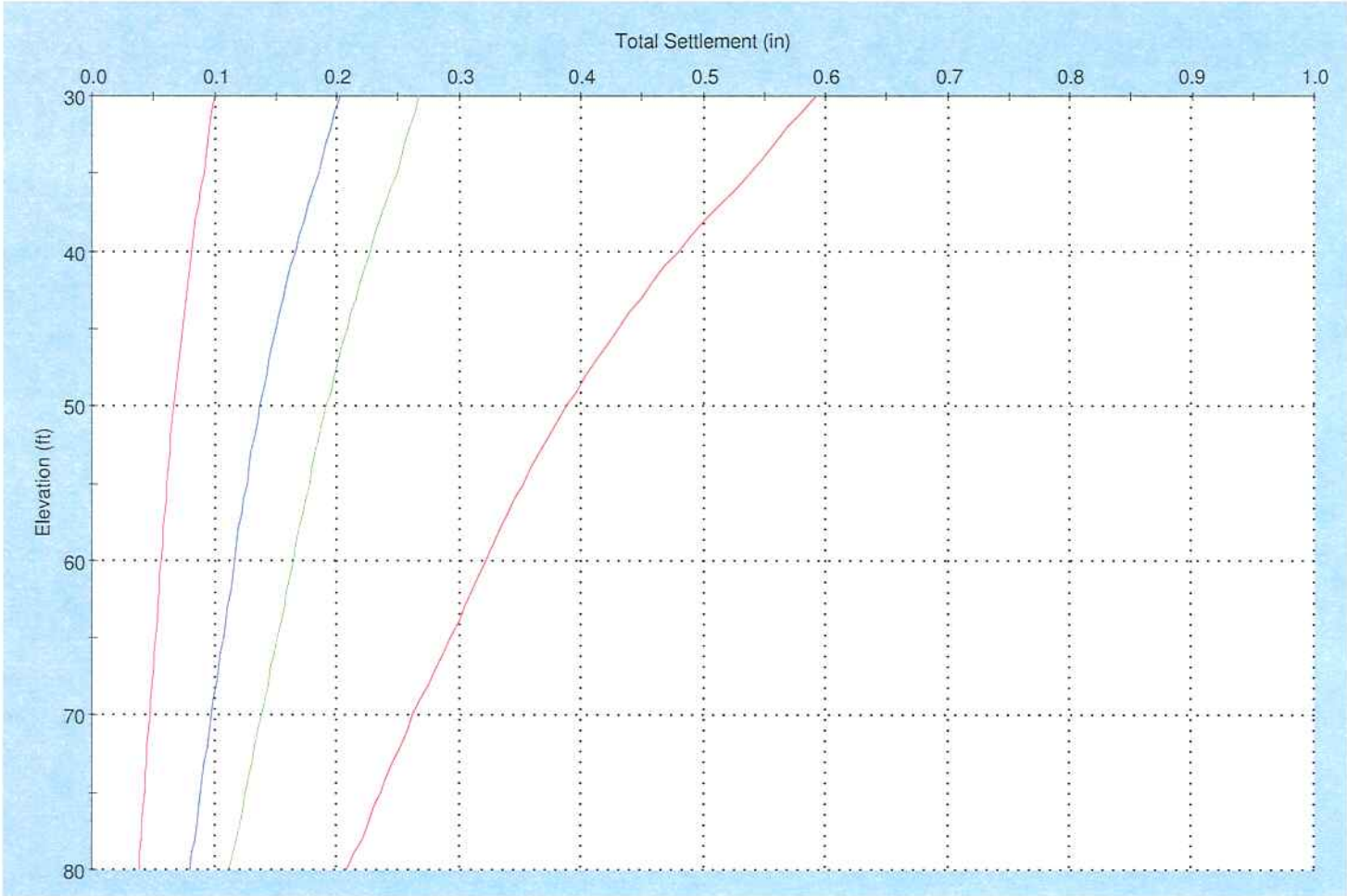

- Query Point 1 (Fill Loads)
- Query Point 2 (Fill Loads)
- Query Point 3 (Fill Loads)
- Query Point 4 (Fill Loads)

Reference Stage: None



SETTLE3D 2.006

Project				St. Mary Parish Franklin Canal Floodgate Structure							
Analysis Description				Settlement Analysis for Fill Loads Evaluated at 2/3 Depth of Pile Embedment							
Drawn By		MKM		Checked By		JJH		Company		Eustis	
Date		1/13/2010, 4:58:02 PM		File Name		Fill + Pile Loads.s3z		Figure 12 Sheet 3			

Data Type:

Total Settlement vs. Depth

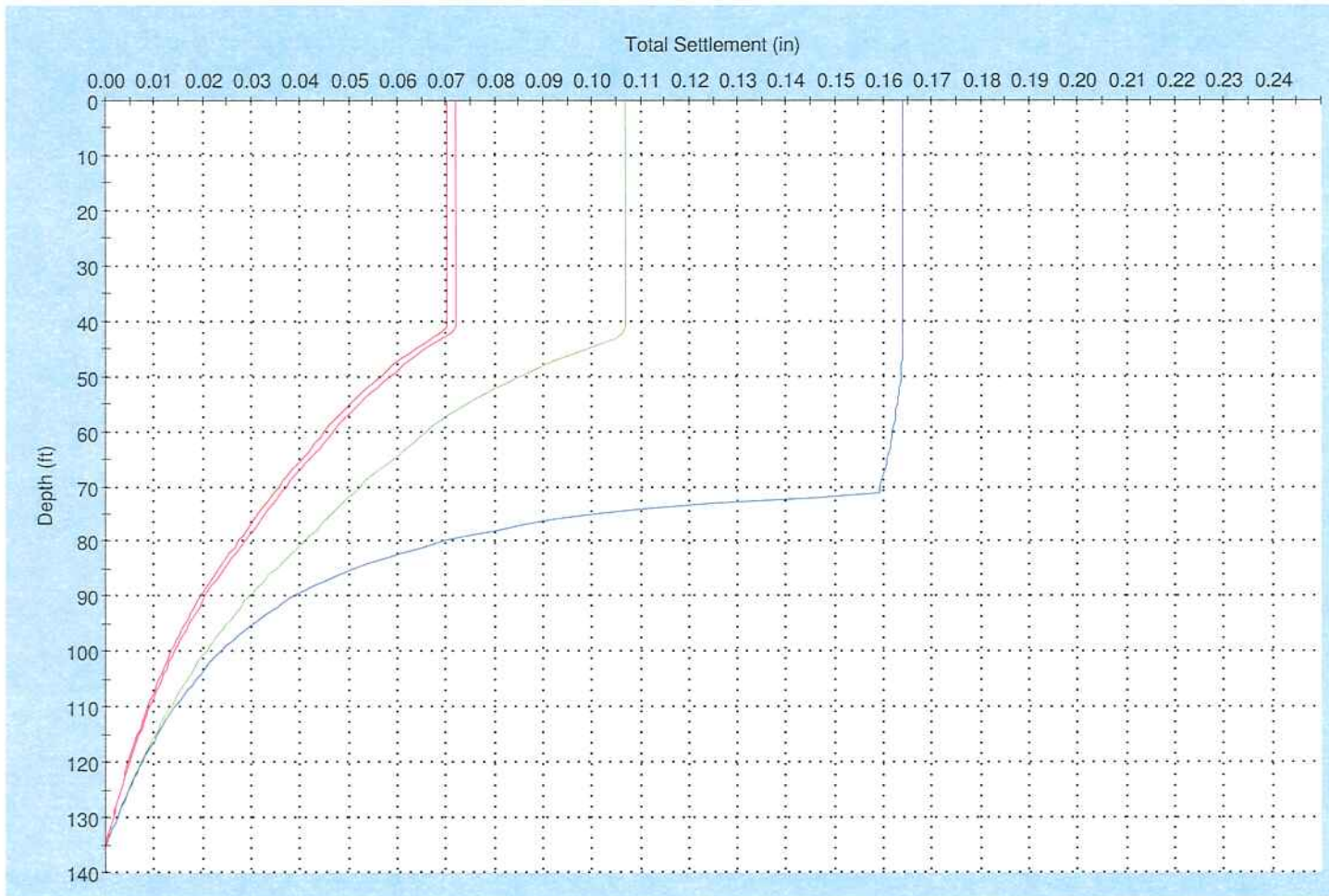

- Query Point 1 (Pile Loads)
- Query Point 2 (Pile Loads)
- Query Point 3 (Pile Loads)
- Query Point 4 (Pile Loads)

Reference Stage: None



<i>Project</i>				St. Mary Parish Franklin Canal Floodgate Structure							
<i>Analysis Description</i>				Settlement Analysis for Pile Loads Evaluated at Pile Tip Elevation							
<i>Drawn By</i>		MKM		<i>Checked By</i>		JJH		<i>Company</i>		Eustis	
<i>Date</i>		1/13/2010, 4:58:02 PM				<i>File Name</i>		Pile Loads.s3z		Figure 12 Sheet 4	

APPENDIX I
BORING LOGS

LOG OF BORING AND TEST RESULTS

ST. MARY PARISH LEVEE DISTRICT
 FLOODGATE STRUCTURE AT FRANKLIN DRAINAGE CANAL
 ST. MARY PARISH, LOUISIANA



Ground Elev.: 9.1 Datum: NAVD88 Gr. Water Depth: See Text Job No.: 20749 Date Drilled: 8/31-9/01/09 Boring: 1 Refer to "Legends & Notes"

Scale In Feet	PP	SPT	S P L R	Symbol	Visual Classification	USC	Sample Number	Depth In Feet	Water Content Percent	Density		Shear Tests			Atterberg Limits			Other Tests	
										Dry	Wet	Type	ø	C	LL	PL	PI		
0					70' Wash														
10																			
20																			
30																			
40							NS	0-70											
50																			

Comments: Latitude: 29° 46.986' N
 Longitude: 91° 31.673' W

LOG OF BORING AND TEST RESULTS

ST. MARY PARISH LEVEE DISTRICT
FLOODGATE STRUCTURE AT FRANKLIN DRAINAGE CANAL
ST. MARY PARISH, LOUISIANA



Ground Elev.: 9.1 Datum: NAVD88 Gr. Water Depth: See Text Job No.: 20749 Date Drilled: 8/31-9/01/09 Boring: 1 Refer to "Legends & Notes"

Scale In Feet	PP	SPT	SPLR	Symbol	Visual Classification	USC	Sample Number	Depth In Feet	Water Content Percent	Density		Shear Tests			Atterberg Limits			Other Tests
										Dry	Wet	Type	φ	C	LL	PL	PI	
50					70' Wash													
					Stiff tan & light gray clay	CH												
	2.50				Stiff reddish-tan & light gray clay w/concretions	CH	1	74-75	36	85	116	OB	0	1142				
	2.50				Stiff tan & light gray clay w/concretions	CH	2	79-80							65	19	46	CONS
	3.50				w/silt pockets & concretions		3	84-85	34	89	119	OB	0	1788				
	1.00				w/silt pockets & fissures		4	89-90	43									
	2.50				Stiff tan & gray clay w/silt pockets	CH	5	94-95	41	81	113	OB	0	1074				
100	2.00						6	99-100	31	90	118	UC	--	1208				

Comments: Latitude: 29° 46.986' N
Longitude: 91° 31.673' W

LOG OF BORING AND TEST RESULTS

ST. MARY PARISH LEVEE DISTRICT
FLOODGATE STRUCTURE AT FRANKLIN DRAINAGE CANAL
ST. MARY PARISH, LOUISIANA



Ground Elev.: 9.1 Datum: NAVD88 Gr. Water Depth: See Text Job No.: 20749 Date Drilled: 8/31-9/01/09 Boring: 1 Refer to "Legends & Notes"

Scale In Feet	PP	SPT	SPLR	Symbol	Visual Classification	USC	Sample Number	Depth In Feet	Water Content Percent	Density		Shear Tests			Atterberg Limits			Other Tests
										Dry	Wet	Type	σ	C	LL	PL	PI	
100					Stiff gray clay w/silt pockets	CH												
1.75					w/silt lenses, trace of wood, & concretions		7	104-105	35	87	117	OB	0	1640				
110					Stiff gray & light brown clay w/silt pockets	CH	8	109-110							55	19	36	CONS
2.25							9	114-115	37	84	116	OB	0	1537				
120					Very stiff gray & tan clay w/silt pockets & concretions	CH	10	119-120	39	82	114	UC	--	1135				
3.00					Very stiff greenish-gray & tan clay w/silt pockets	CH	11	124-125	28	96	123	UC	--	2034				
130					Very stiff gray & tan clay	CH	12	129-130							63	22	41	CONS
4.00					w/silt pockets & concretions		13	134-135	27	97	123	OB	0	2390				
140							14	139-140	30	93	121	UC	--	2549				
4.00					Extremely stiff gray & tan clay	CH	15	144-145	29	95	122	UC	--	2353				
150							16	149-150	29	94	121	UC	--	2134				

Comments: Latitude: 29° 46.986' N
Longitude: 91° 31.673' W

LOG OF BORING AND TEST RESULTS
 ST. MARY PARISH LEVEE DISTRICT
 FLOODGATE STRUCTURE AT FRANKLIN DRAINAGE CANAL
 ST. MARY PARISH, LOUISIANA



Ground Elev.: 4.5 Datum: NAVD88 Gr. Water Depth: See Text Job No.: 20749 Date Drilled: 9/02/09 Boring: 2 Refer to "Legends & Notes"

Scale In Feet	PP	SPT	S P L R	Symbol	Visual Classification	USC	Sample Number	Depth In Feet	Water Content Percent	Density		Shear Tests			Atterberg Limits			Other Tests	
										Dry	Wet	Type	ø	C	LL	PL	PI		
0					70' Wash														
10																			
20																			
30																			
40							NS	0-70											
50																			

Comments: Latitude: 29° 47.023' N
 Longitude: 91° 31.687' W

LOG OF BORING AND TEST RESULTS

ST. MARY PARISH LEVEE DISTRICT
FLOODGATE STRUCTURE AT FRANKLIN DRAINAGE CANAL
ST. MARY PARISH, LOUISIANA



Ground Elev.: 4.5 Datum: NAVD88 Gr. Water Depth: See Text Job No.: 20749 Date Drilled: 9/02/09 Boring: 2 Refer to "Legends & Notes"

Scale In Feet	PP	SPT	S P L R	Symbol	Visual Classification	USC	Sample Number	Depth In Feet	Water Content Percent	Density		Shear Tests			Atterberg Limits			Other Tests
										Dry	Wet	Type	ø	C	LL	PL	PI	
50					70' Wash													
					Dense tan silty sand	SM												
	2.00				Stiff gray & tan clay w/silt pockets & lenses	CH	1	74-75	26	97	123	OB	0	1049				
					w/shell fragments													
	2.50						2	79-80	39	82	114	OB	0	1148				
	2.50				Medium stiff gray & tan clay w/silt pockets & lenses, & shell fragments	CH	3	84-85	36									
	1.50						4	89-90	42	80	113	OB	0	798				
	1.75						5	94-95	37	84	115	UC	-	1068				
	1.25				w/silt pockets		6	99-100	40	80	112	OB	0	1210				

Comments: Latitude: 29° 47.023' N
Longitude: 91° 31.687' W

LOG OF BORING AND TEST RESULTS

ST. MARY PARISH LEVEE DISTRICT
FLOODGATE STRUCTURE AT FRANKLIN DRAINAGE CANAL
ST. MARY PARISH, LOUISIANA



Ground Elev.: 4.5 Datum: NAVD88 Gr. Water Depth: See Text Job No.: 20749 Date Drilled: 9/02/09 Boring: 2 Refer to "Legends & Notes"

Scale In Feet	PP	SPT	S P L R	Symbol	Visual Classification	USC	Sample Number	Depth In Feet	Water Content Percent	Density		Shear Tests			Atterberg Limits			Other Tests
										Dry	Wet	Type	σ	C	LL	PL	PI	
100					Medium stiff gray & tan clay w/silt pockets & layers	CH												
1.75					Stiff gray & brown clay w/silty sand pockets & lenses, & shell fragments	CH	7	104-105	39	81	112	UC	--	513				
110					Stiff gray clay w/silt pockets	CH	8	109-110	32									
2.00					Very stiff gray clay w/silty sand pockets & lenses	CH	9	114-115	24	103	127	UC	--	1862				
120					Very stiff greenish-gray clay w/concretions	CH	10	119-120	21	108	131	OB	0	2266				
3.75					Very stiff light gray & tan clay w/concretions & trace of decayed wood (fissured)	CH	11	124-125	32	91	119	OB	0	2051				
130					Very stiff light gray, tan, & brown clay w/silt lenses, trace of decayed wood, & concretions	CH	12	129-130	32	90	119	UC	--	2211				
3.50					Extremely stiff gray & tan clay	CH	13	134-135	32									
140							14	139-140	35	86	117	UC	--	1476				
3.00							15	144-145	26	98	124	OB	0	3984				
150							16	149-150	27									

Comments: Latitude: 29° 47.023' N
Longitude: 91° 31.687' W

LOG OF BORING AND TEST RESULTS

ST. MARY PARISH LEVEE DISTRICT
FLOODGATE STRUCTURE AT FRANKLIN DRAINAGE CANAL
ST. MARY PARISH, LOUISIANA



Ground Elev.: 4.5 Datum: NAVD88 Gr. Water Depth: See Text Job No.: 20749 Date Drilled: 9/03/09 Boring: 3 Refer to "Legends & Notes"

Scale In Feet	PP	SPT	SPLR	Symbol	Visual Classification	USC	Sample Number	Depth In Feet	Water Content Percent	Density		Shear Tests			Atterberg Limits			Other Tests
										Dry	Wet	Type	σ	C	LL	PL	PI	
0					Very stiff gray & brown silty clay w/shell fragments	CL	1	2-3	22	100	122	UC	-	3645				
3.50					Medium stiff brown & tan clay w/roots & silt pockets	CH	2	5-6	29	95	123	OB	0	817	51	18	33	
1.00					Soft dark gray clay w/silt pockets & roots	CH	3	8-9	42	80	113	OB	0	488				
0.75					Medium stiff light gray & tan silty clay w/concretions	CL	4	11-12	32	90	119	UC	-	557				
0.75					Medium stiff brown & light gray silty clay w/sandy silt layers	CL	5	14-15	31	90	119	OB	0	528				
0.25					w/concretions		6	19-20	32	90	119	UC	-	610				
0.75					Soft light gray, brown, & tan silty clay w/concretions	CL	7	24-25	29	93	120	OB	0	809	39	20	19	
1.25							8	29-30	38	83	114	OB	0	323				
0.25							9	34-35	34	87	118	OB	0	335				
							10	39-40	37	85	116	UC	-	351				
40					Very stiff tan & gray & light gray clay w/concretions	CH	11	44-45	23									
2.25					w/decayed wood		12	49-50	29	94	122	UC	-	2380				
50	3.00																	

Comments: Latitude: 29° 47.076' N
Longitude: 91° 31.690' W

LOG OF BORING AND TEST RESULTS

ST. MARY PARISH LEVEE DISTRICT
FLOODGATE STRUCTURE AT FRANKLIN DRAINAGE CANAL
ST. MARY PARISH, LOUISIANA



Ground Elev.: 4.5 Datum: NAVD88 Gr. Water Depth: See Text Job No.: 20749 Date Drilled: 9/03/09 Boring: 3 Refer to "Legends & Notes"

Scale In Feet	PP	SPT	S P L R	Symbol	Visual Classification	USC	Sample Number	Depth In Feet	Water Content Percent	Density		Shear Tests			Atterberg Limits			Other Tests	
										Dry	Wet	Type	φ	C	LL	PL	PI		
50					Very stiff tan & gray & light gray clay w/decayed wood	CH													
2.75					w/concretions (fissured)		13	54-55	29										
60						Very stiff tan & gray silty clay w/silt lenses	CL	14	59-60	30	93	122	UC			1974			
3.50						Very stiff tan & gray clay w/concretions	CH	15	64-65	33									
70								16	69-70	33									
2.25						w/trace of silt & concretions		17	74-75	31									
80							18	79-80	26										
90																			
100																			

Comments: Latitude: 29° 47.076' N
Longitude: 91° 31.690' W

ELEVATIONS IN FEET - N.G.V.D.

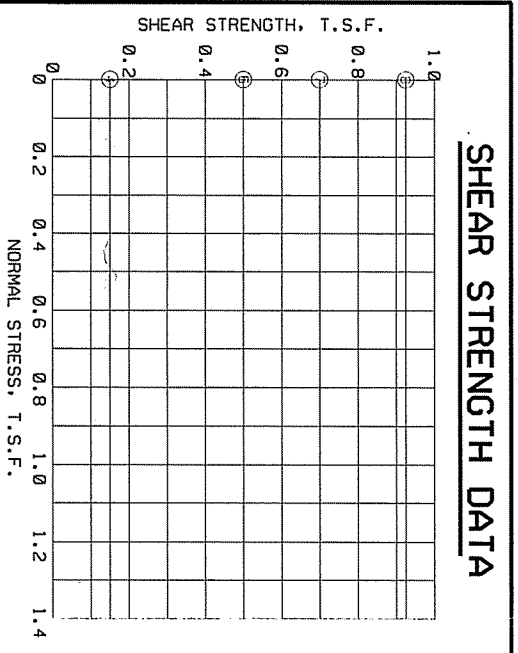
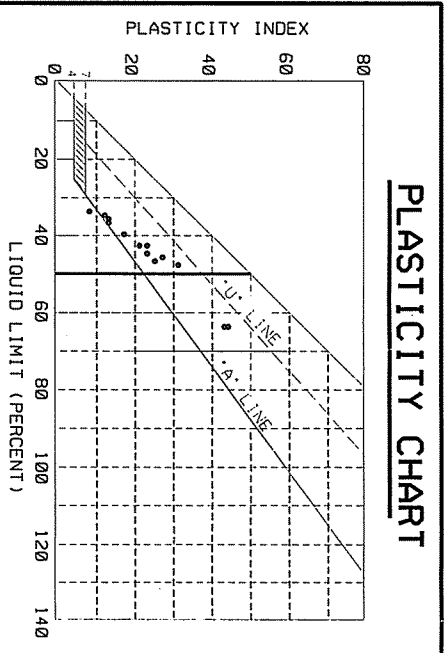
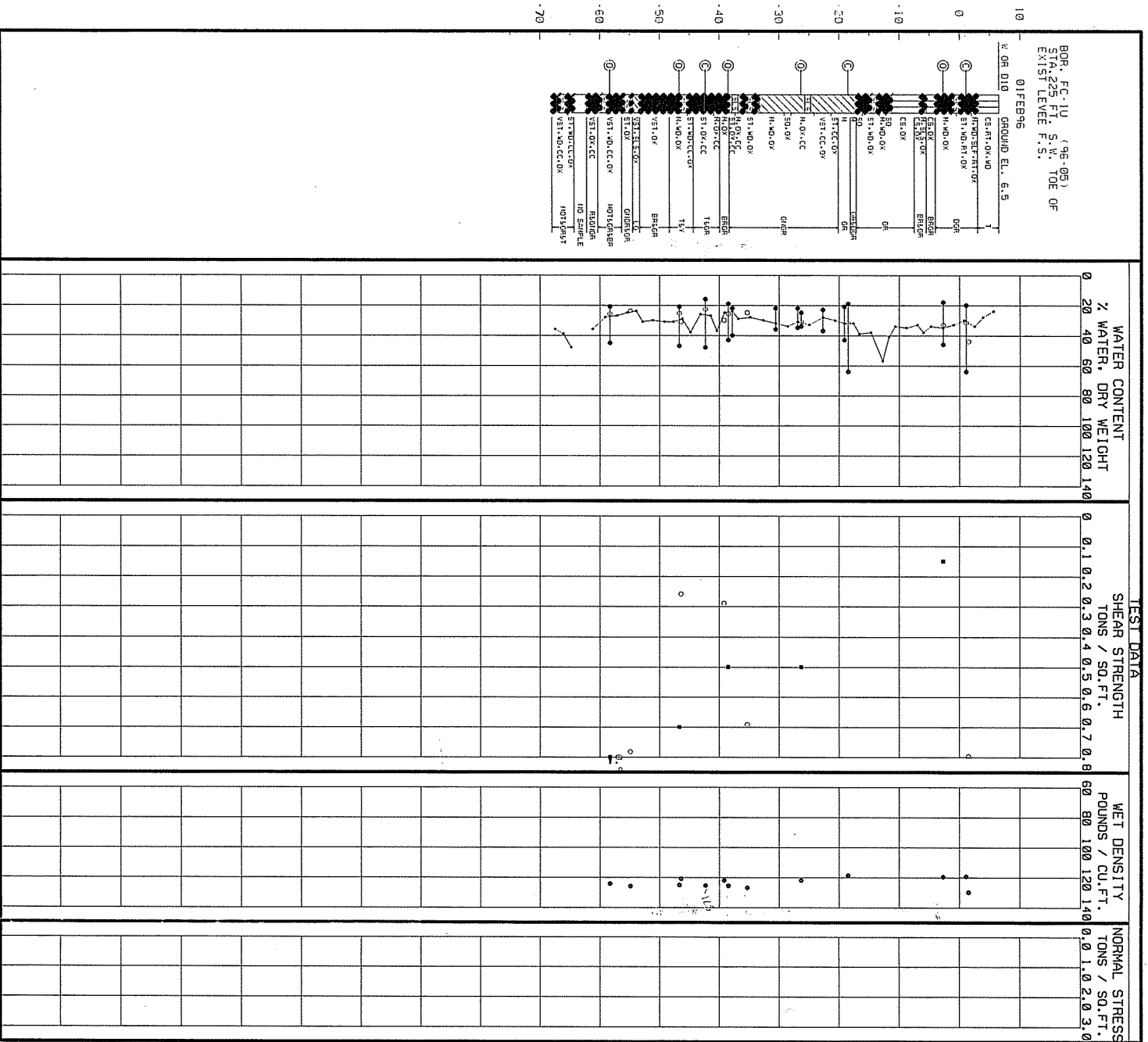

NOTES

- (UC) UNCONFINED COMPRESSION TEST
- (O) UNCONSOLIDATED - UNDRAINED TRIAXIAL SHEAR TEST
- ▲ (R) CONSOLIDATED - UNDRAINED TRIAXIAL SHEAR TEST
- (S) CONSOLIDATED - DRAINED DIRECT SHEAR TEST
- _{UP} ○_{DN} ○_{UL} AFTERBERG LIMITS

BORING WAS TAKEN WITH A 5 INCH DIAMETER STEEL TUBE PISTON TYPE SAMPLER. FOR SOIL BORING LEGEND SEE PLATE A. FOR LOCATION OF BORINGS SEE PLATE FOR DETAILED TEST DATA SEE

TABULAR TEST DATA

ENVELOPE NO.	EL.	TYPE	STRENGTH ϕ	C - TSF	CLASS
1	1.10	C	0.0	0.000	CH
2	18.50	C	0.0	0.000	CH
3	42.30	C	0.0	0.000	CH
4	2.70	O	0.0	0.150	CL
5	26.30	O	0.0	0.500	HL
6	38.50	O	0.0	0.500	CL
7	46.70	O	0.0	0.700	CL
8	59.30	O	0.0	0.925	CL

DESIGNED BY:  DATE: _____

DRAWN BY: _____ DATE: _____

CHECKED BY: _____ DATE: _____

U.S. Army ENGINEER DISTRICT, NEW ORLEANS
CORPS OF ENGINEERS
NEW ORLEANS, LOUISIANA

PLOT SCALE: _____ PLOT DATE: _____

FILE NO. _____

PLATE

FC-10

ELEVATIONS IN FEET - N.G.V.D.

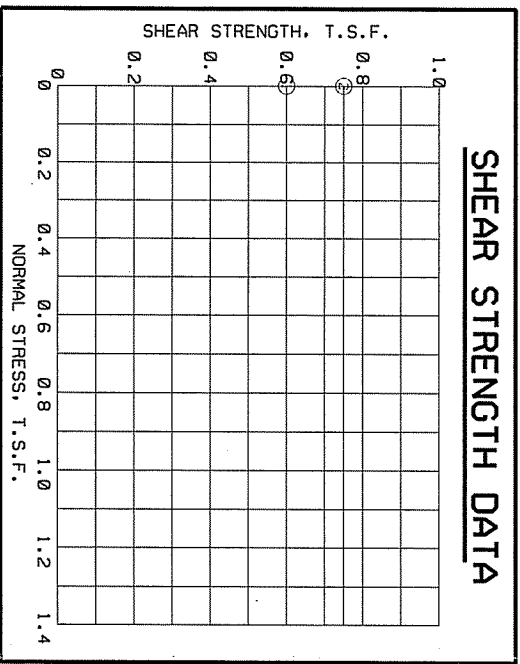
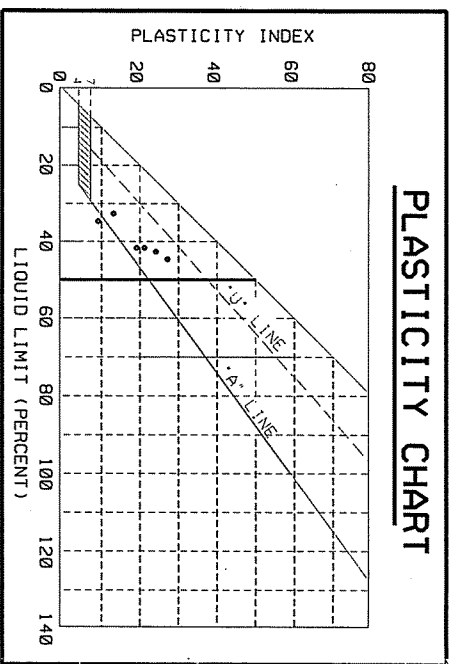
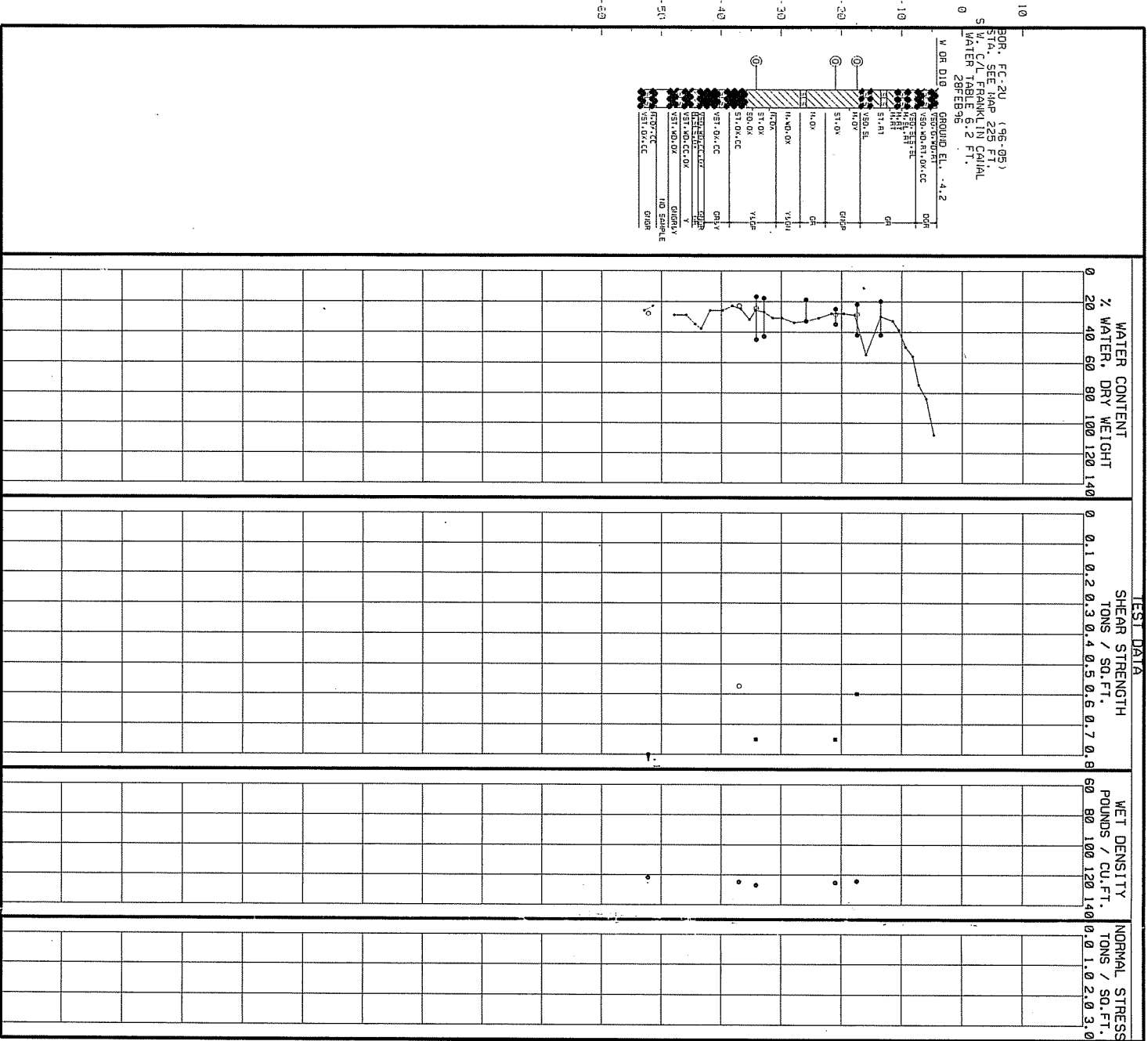

ENVELOPE NO.	EL.	TYPE	STRENGTH CLASS
1	-17.40	0	0.0 0.500 CL
2	-21.00	0	0.0 0.750 CL
3	-34.20	0	0.0 0.750 CL

NOTES

- - (UC) UNCONFINED COMPRESSION TEST
- - (O) UNCONSOLIDATED - UNDRAINED TRIAXIAL SHEAR TEST
- ▲ - (R) CONSOLIDATED - UNDRAINED TRIAXIAL SHEAR TEST
- - (S) CONSOLIDATED - DRAINED DIRECT SHEAR TEST
- _{UP} ○_{UN} ○_{OL} ATTERBERG LIMITS

BORING WAS TAKEN WITH A 5 INCH DIAMETER STEEL TUBE PISTON TYPE SAMPLER. FOR SOIL BORING LEGEND SEE PLATE A. FOR LOCATION OF BORINGS SEE PLATE A. FOR DETAILED TEST DATA SEE

U.S. Army Engineers District, New Orleans
Corps of Engineers
New Orleans, Louisiana

DESIGNED BY: [Signature]
 DRAWN BY: [Signature]
 CHECKED BY: [Signature]

DATE: [Blank]
 PLOT SCALE: [Blank] PLOT ORIENT: [Blank] GRID FILE: [Blank]
 FILE NO.: [Blank]

PLATE

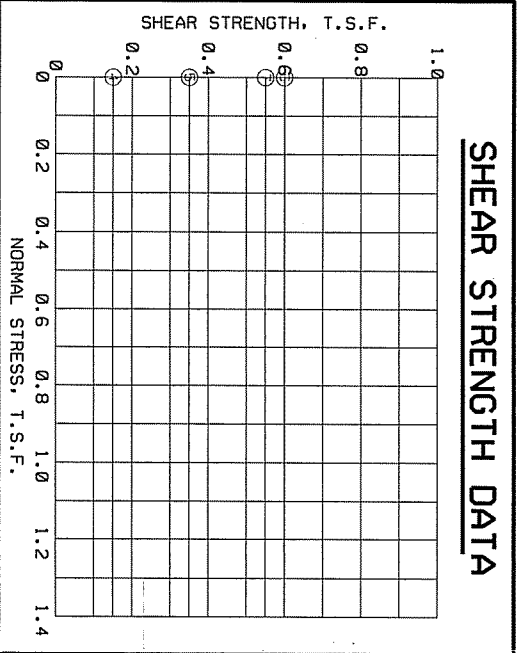
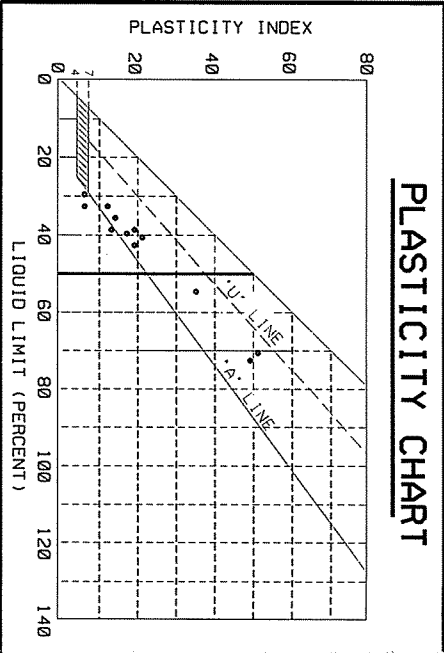
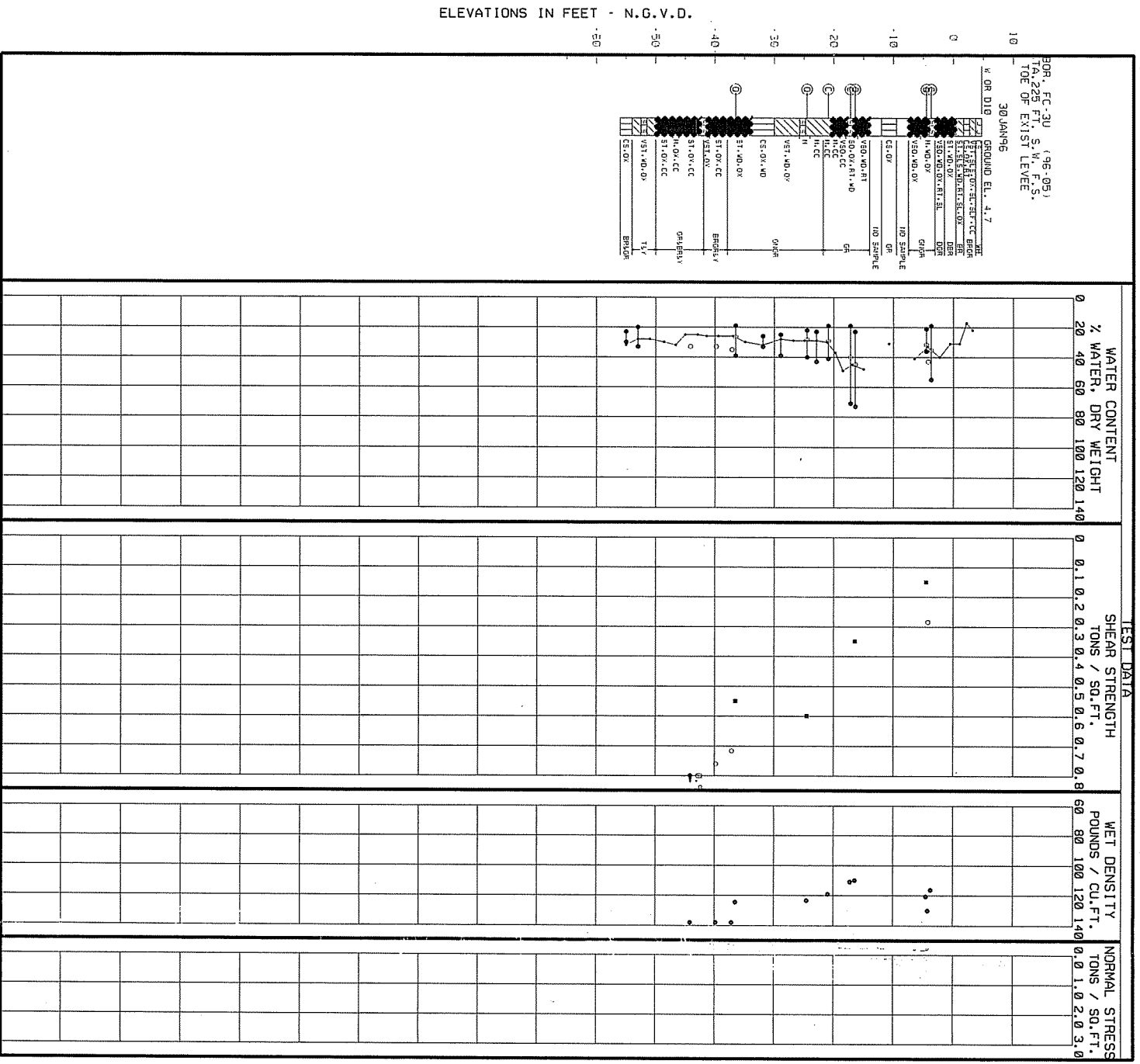

TABULAR TEST DATA

ENVELOPE NO.	EL.	TYPE	STRENGTH ϕ	CLASS
1	-3.70	C	0.0	CH
2	-17.20	C	0.0	CH
3	-20.90	C	0.0	CH
4	-4.50	0	0.0	CL
5	-15.40	0	0.0	CH
6	-24.50	0	0.0	CL
7	-36.50	0	0.0	CL

NOTES

- (UC) UNCONFINED COMPRESSION TEST
- (O) UNCONSOLIDATED - UNDRAINED TRIAXIAL SHEAR TEST
- ▲ (R) CONSOLIDATED - UNDRAINED TRIAXIAL SHEAR TEST
- (S) CONSOLIDATED - DRAINED DIRECT SHEAR TEST
- _{UP} ○_{UN} ○_{UL} ATTERBERG LIMITS

BORING WAS TAKEN WITH A 5 INCH DIAMETER STEEL TUBE PISTON TYPE SAMPLER.
FOR SOIL BORING LEGEND SEE PLATE A.
FOR LOCATION OF BORINGS SEE PLATE FOR DETAILED TEST DATA SEE

U.S. Army Corps of Engineers
NEW ORLEANS DISTRICT
NEW ORLEANS, LOUISIANA

DESIGNED BY: _____
DRAWN BY: _____
CHECKED BY: _____

DATE: _____

FILE NO. _____

PLATE

APPENDIX II
CONSOLIDATION TEST RESULTS

CONSOLIDATION TEST REPORT

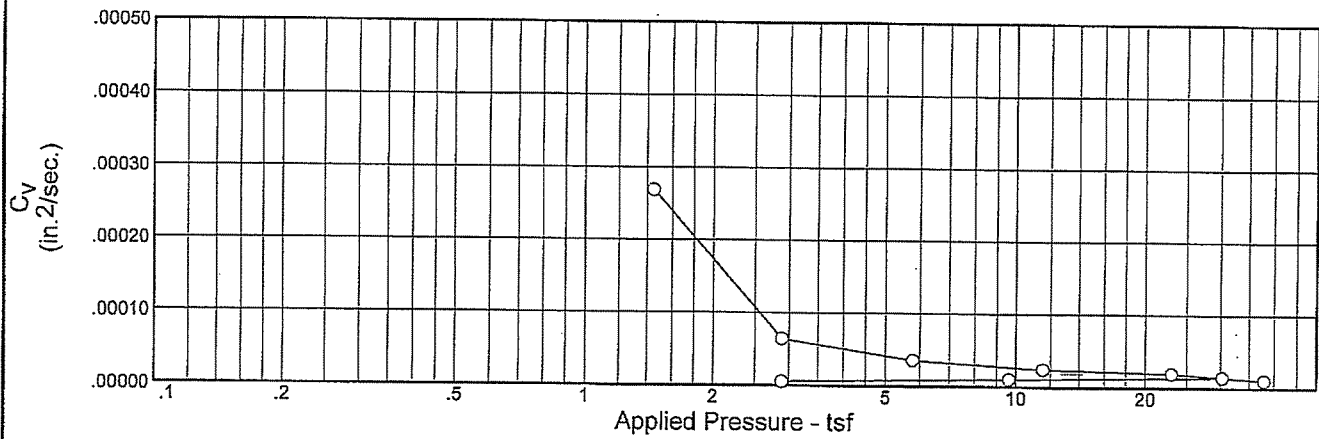
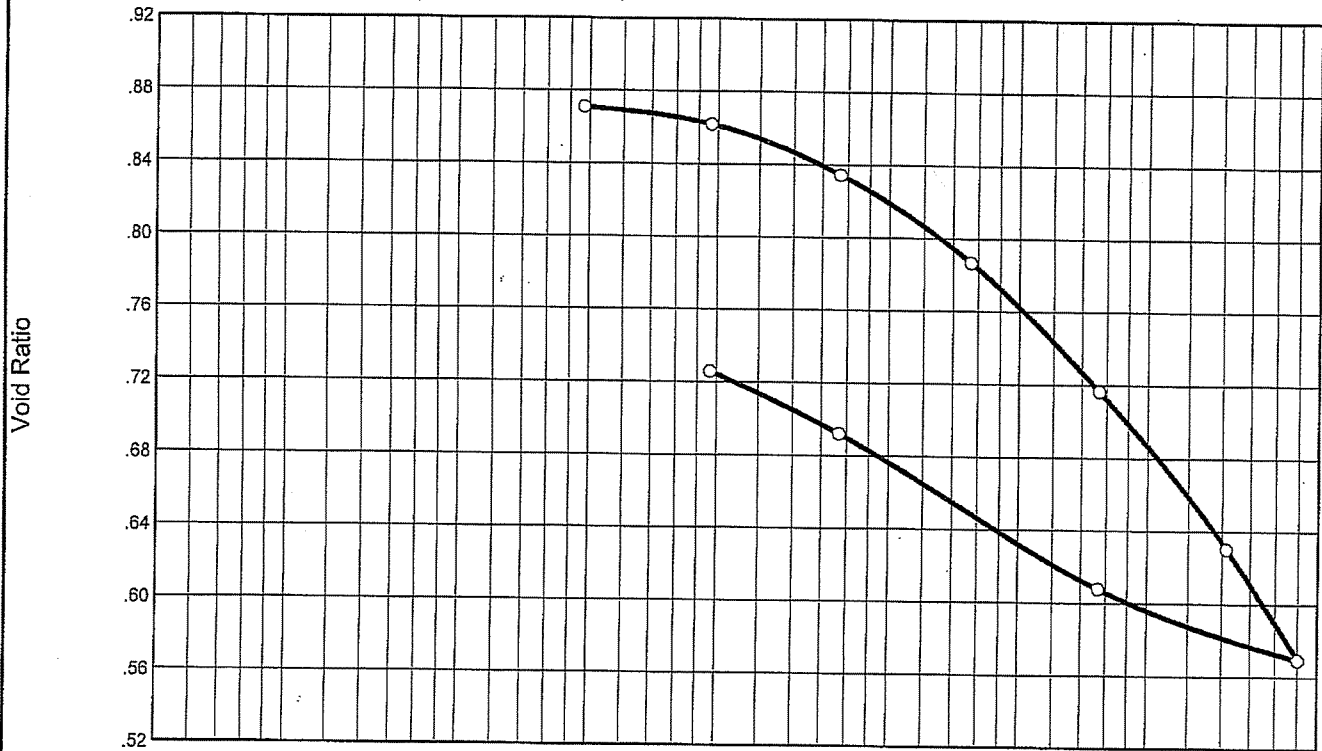

Natural		Dry Dens. (pcf)	LL	PI	Sp. Gr.	P _c (tsf)	C _c	Initial Void Ratio
Saturation	Moisture							
97.3 %	31.2 %	90.8	65	46	2.74	8.56	0.37	0.879

MATERIAL DESCRIPTION		USCS	AASHTO
VST RD-T & LT-G CL W/ CONC (FLOC)		CH	

Project No. 20749	Client:	Remarks: TESTED BY: RR CHECKED BY: RNE
Project: FRANKLIN CANAL FLOODGATE AND LEVEE		
Source: B-1	Sample No.: 2	
		Elev./Depth: 79.0'
EUSTIS Metairie, Louisiana Lafayette, Louisiana Gulfport, Mississippi		Figure

Dial Reading vs. Time

Project No.: 20749

Project: FRANKLIN CANAL FLOODGATE AND LEVEE

Source: B-1

Sample No.: 2

Elev./Depth: 79.0'

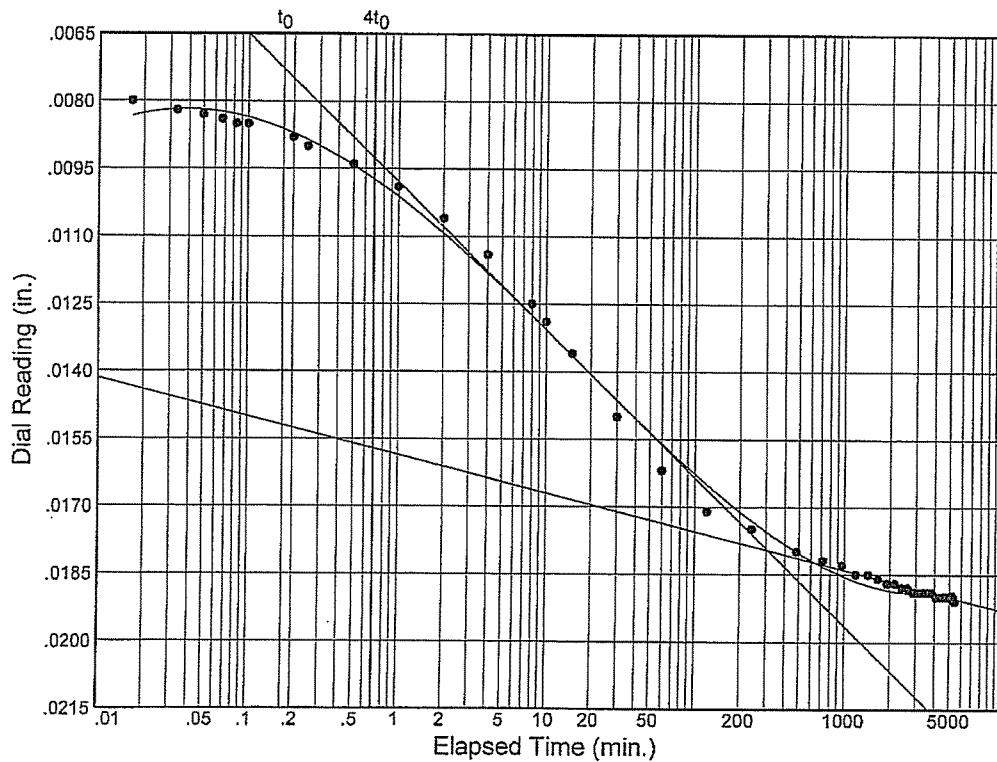
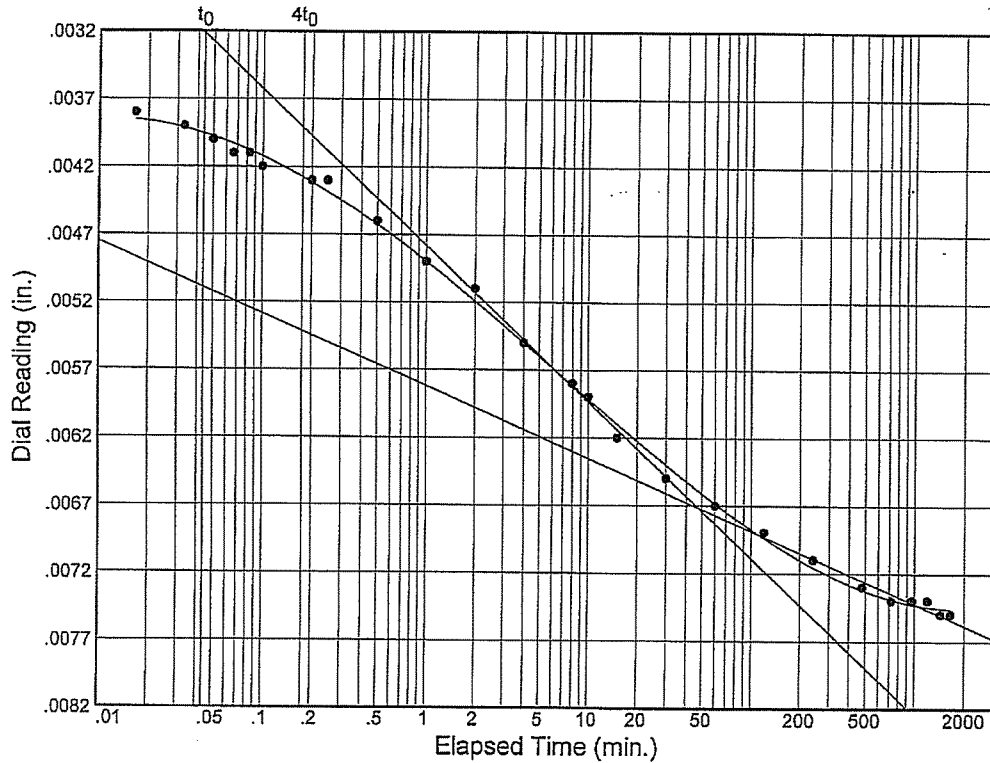

Dial Reading vs. Time

Project No.: 20749
 Project: FRANKLIN CANAL FLOODGATE AND LEVEE

Source: B-1

Sample No.: 2

Elev./Depth: 79.0'

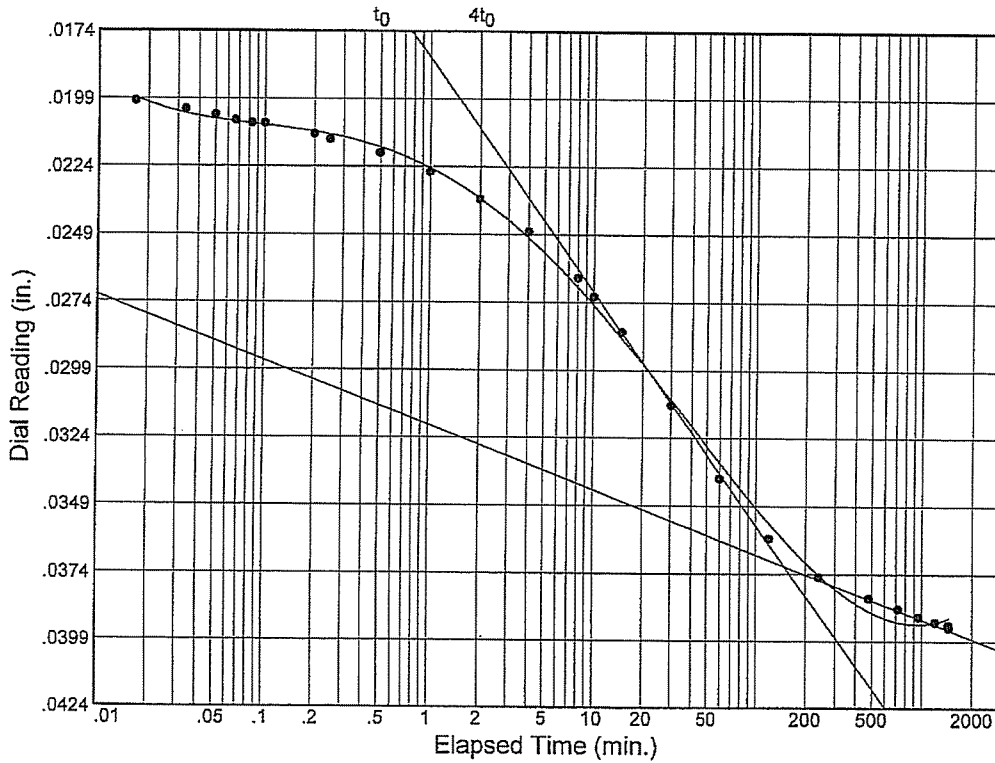

Load No.= 4
 Load= 7.69 tsf
 $D_0 = 0.01981$
 $D_{50} = 0.02846$
 $D_{100} = 0.03711$
 $T_{50} = 13.73 \text{ min.}$

$C_v @ T_{50}$
 0.0000 in.²/sec.

$C_\alpha = 0.003$

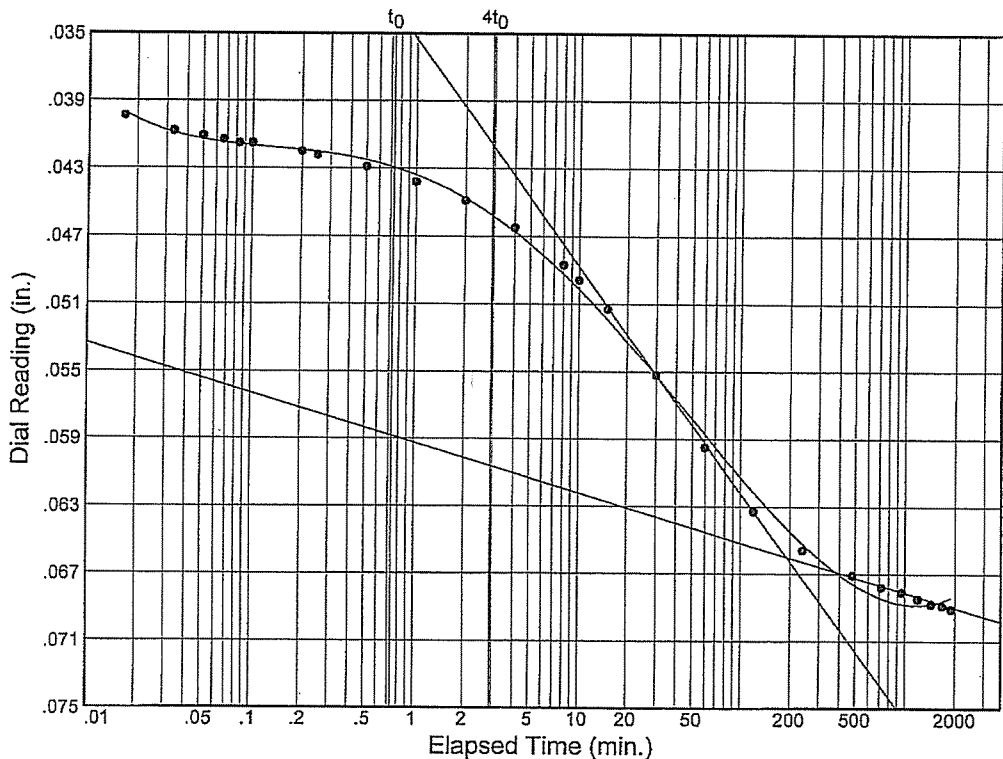

Load No.= 5
 Load= 15.37 tsf
 $D_0 = 0.04009$
 $D_{50} = 0.05304$
 $D_{100} = 0.06600$
 $T_{50} = 19.18 \text{ min.}$

$C_v @ T_{50}$
 0.0000 in.²/sec.

$C_\alpha = 0.004$

Dial Reading vs. Time

Project No.: 20749
 Project: FRANKLIN CANAL FLOODGATE AND LEVEE

Source: B-1

Sample No.: 2

Elev./Depth: 79.0'

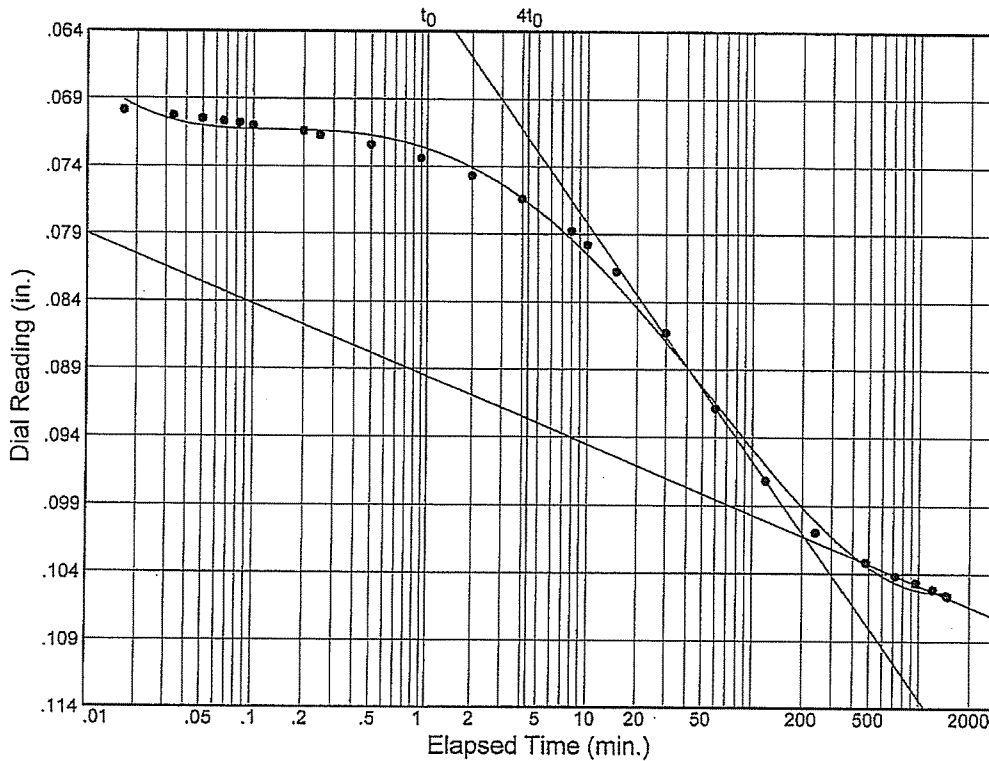

Load No.= 6
 Load= 30.73 tsf
 $D_0 = 0.06870$
 $D_{50} = 0.08502$
 $D_{100} = 0.10135$
 $T_{50} = 21.96 \text{ min.}$

$C_v @ T_{50}$
 0.0000 in.²/sec.

$C_\alpha = 0.007$

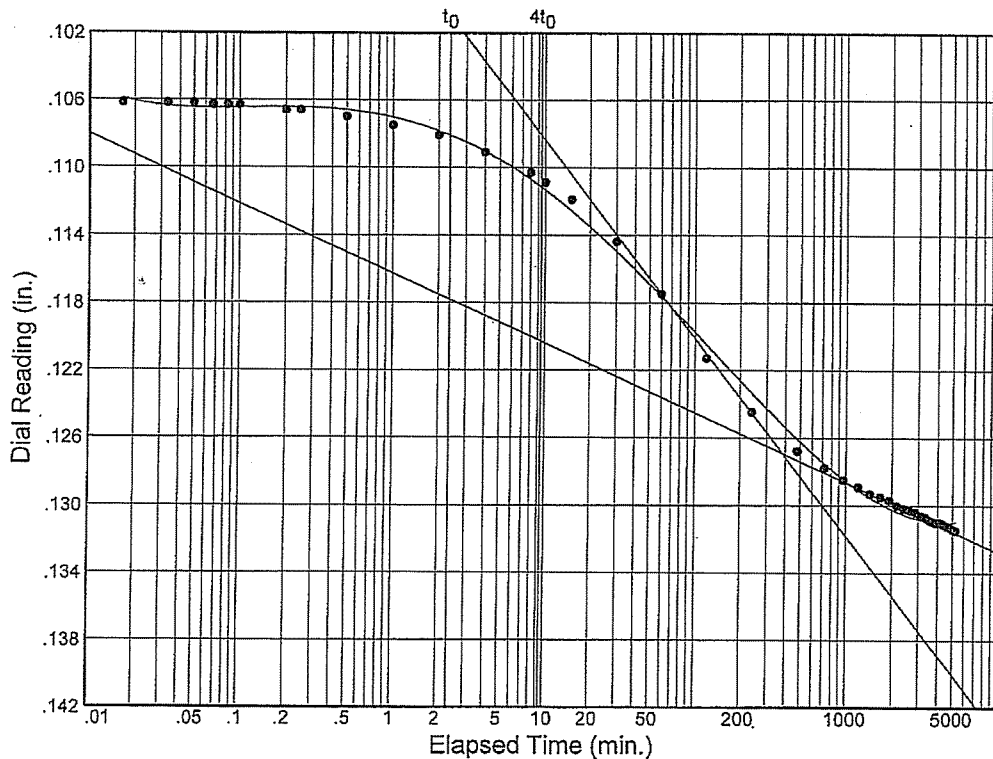

Load No.= 7
 Load= 45.21 tsf
 $D_0 = 0.10501$
 $D_{50} = 0.11596$
 $D_{100} = 0.12691$
 $T_{50} = 38.99 \text{ min.}$

$C_v @ T_{50}$
 0.0000 in.²/sec.

$C_\alpha = 0.006$

Dial Reading vs. Time

Project No.: 20749
 Project: FRANKLIN CANAL FLOODGATE AND LEVEE

Source: B-1

Sample No.: 2

Elev./Depth: 79.0'

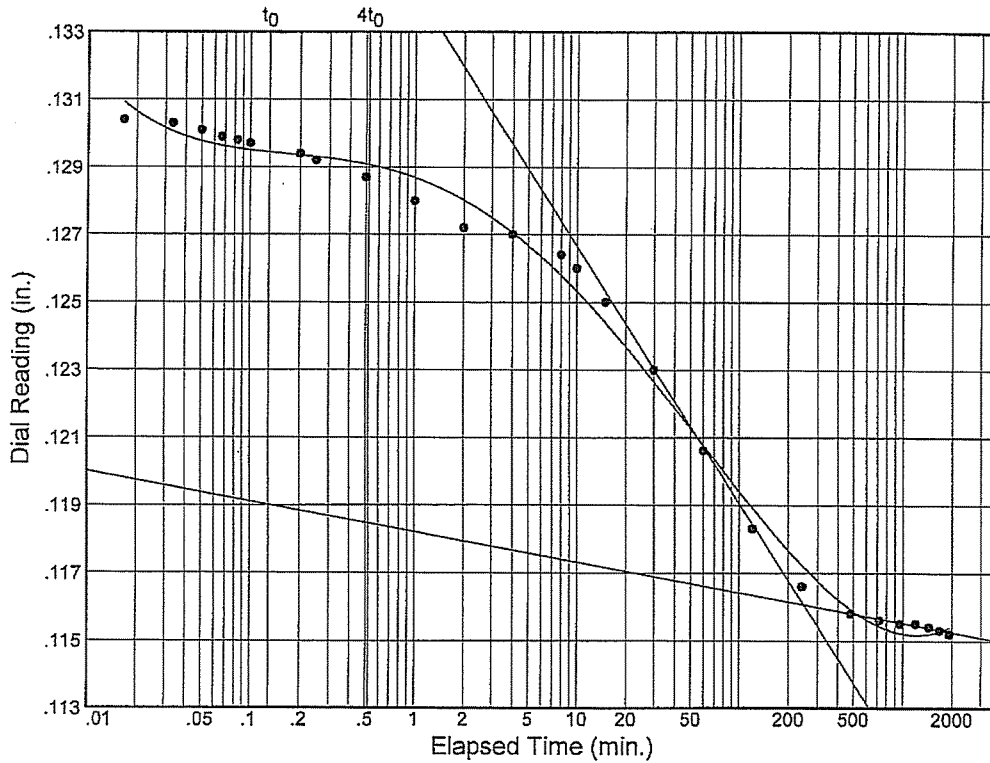

Load No.= 8
 Load= 15.37 tsf
 $D_0 = 0.12982$
 $D_{50} = 0.12294$
 $D_{100} = 0.11607$
 $T_{50} = 26.82 \text{ min.}$

$C_v @ T_{50}$
 0.0000 in.²/sec.

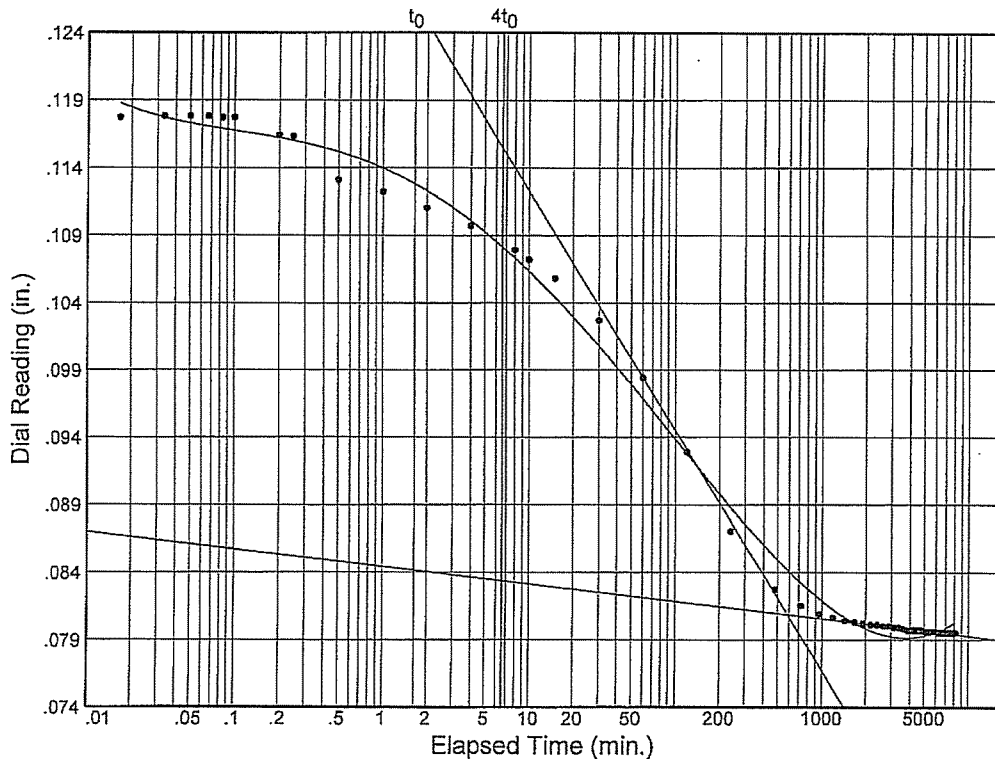

Load No.= 9
 Load= 3.85 tsf
 $D_0 = 0.11747$
 $D_{50} = 0.09917$
 $D_{100} = 0.08086$
 $T_{50} = 40.10 \text{ min.}$

$C_v @ T_{50}$
 0.0000 in.²/sec.

Dial Reading vs. Time

Project No.: 20749

Project: FRANKLIN CANAL FLOODGATE AND LEVEE

Source: B-1

Sample No.: 2

Elev./Depth: 79.0'

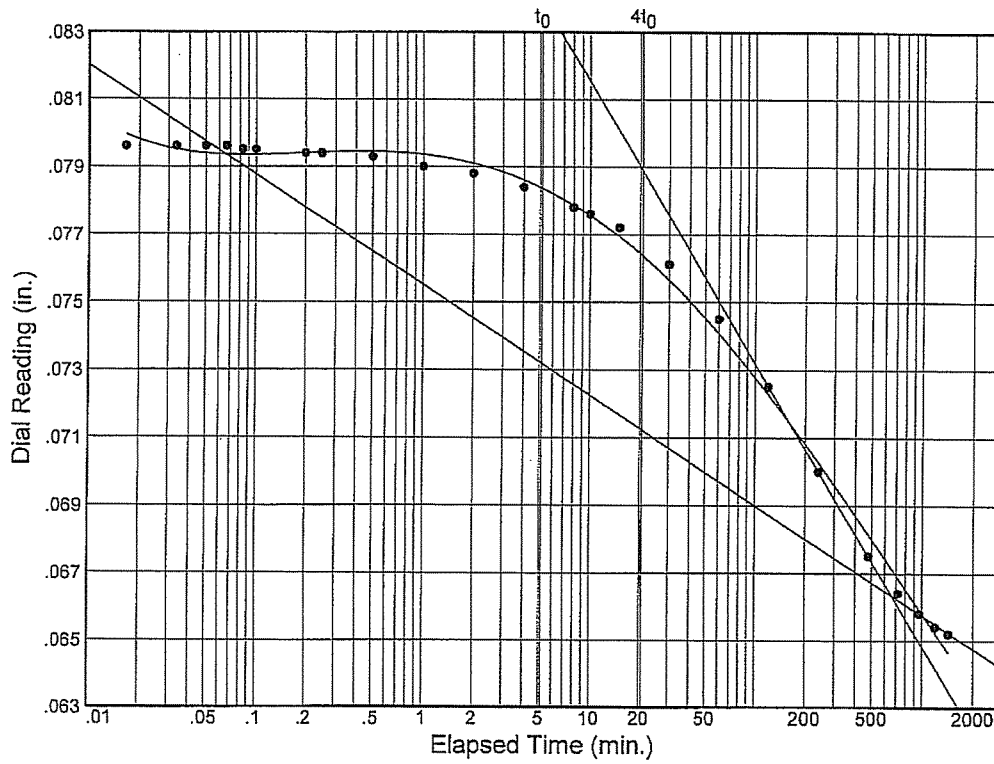

Load No.= 10

Load= 1.93 tsf

$D_0 = 0.08036$

$D_{50} = 0.07334$

$D_{100} = 0.06633$

$T_{50} = 80.55 \text{ min.}$

$C_v @ T_{50}$

0.0000 in.2/sec.

CONSOLIDATION TEST REPORT

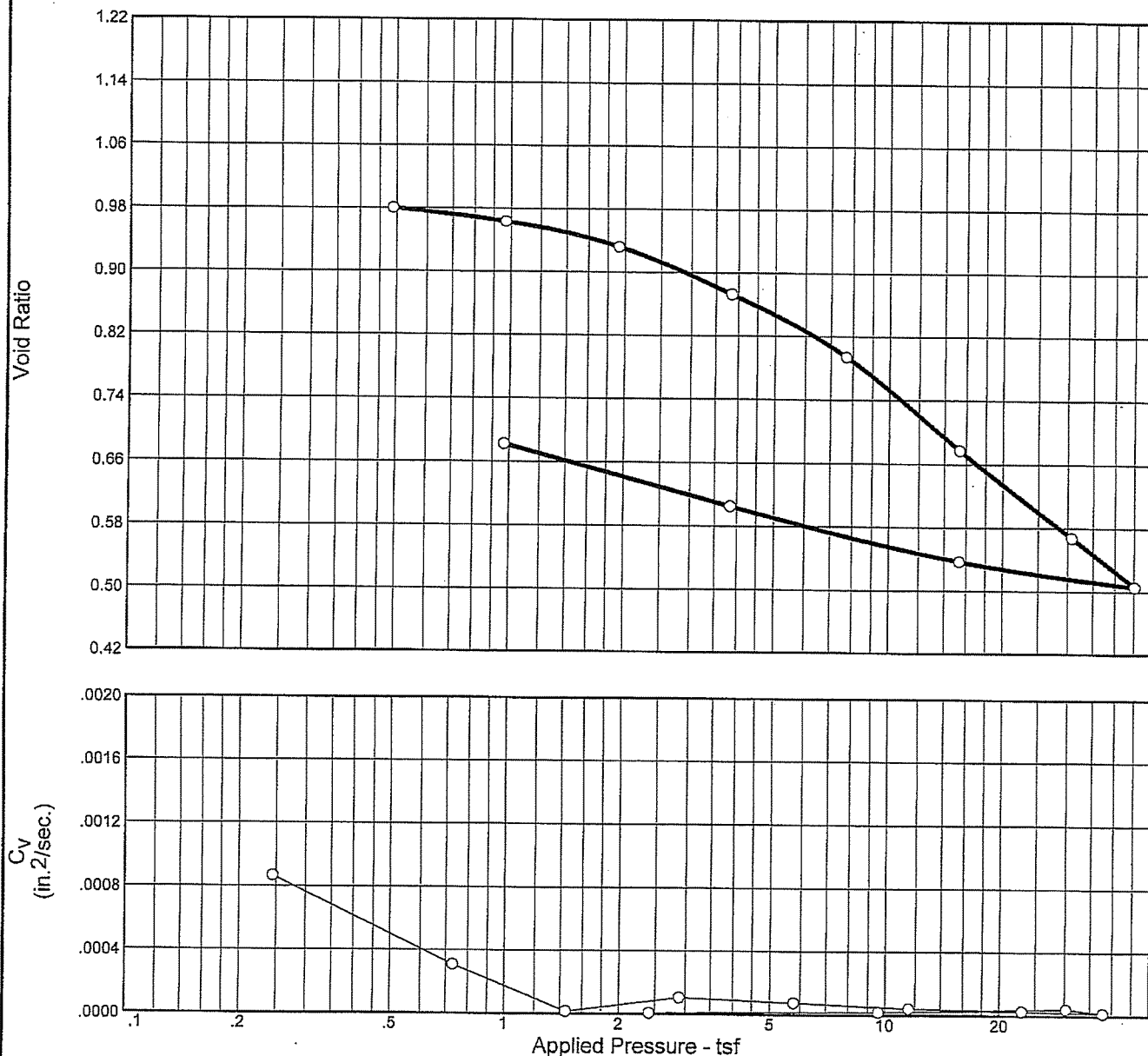

Natural		Dry Dens. (pcf)	LL	PI	Sp. Gr.	P _c (tsf)	C _c	Initial Void Ratio
Saturation	Moisture							
98.5 %	35.6 %	85.6	55	36	2.72	3.81	0.38	0.983

MATERIAL DESCRIPTION							USCS	AASHTO
ST G CL W/ SI LEN, TR-WD, CONC							CH	

Project No. 20749	Client:	Remarks: TESTED BY: RR CHECKED BY: RNE
Project: FRANKLIN CANAL FLOODGATE AND LEVEE		
Source: B-1	Sample No.: 8	
		Elev./Depth: 109.0'
EUSTIS Metairie, Louisiana Lafayette, Louisiana Gulfport, Mississippi		Figure

Dial Reading vs. Time

Project No.: 20749

Project: FRANKLIN CANAL FLOODGATE AND LEVEE

Source: B-1

Sample No.: 8

Elev./Depth: 109.0'

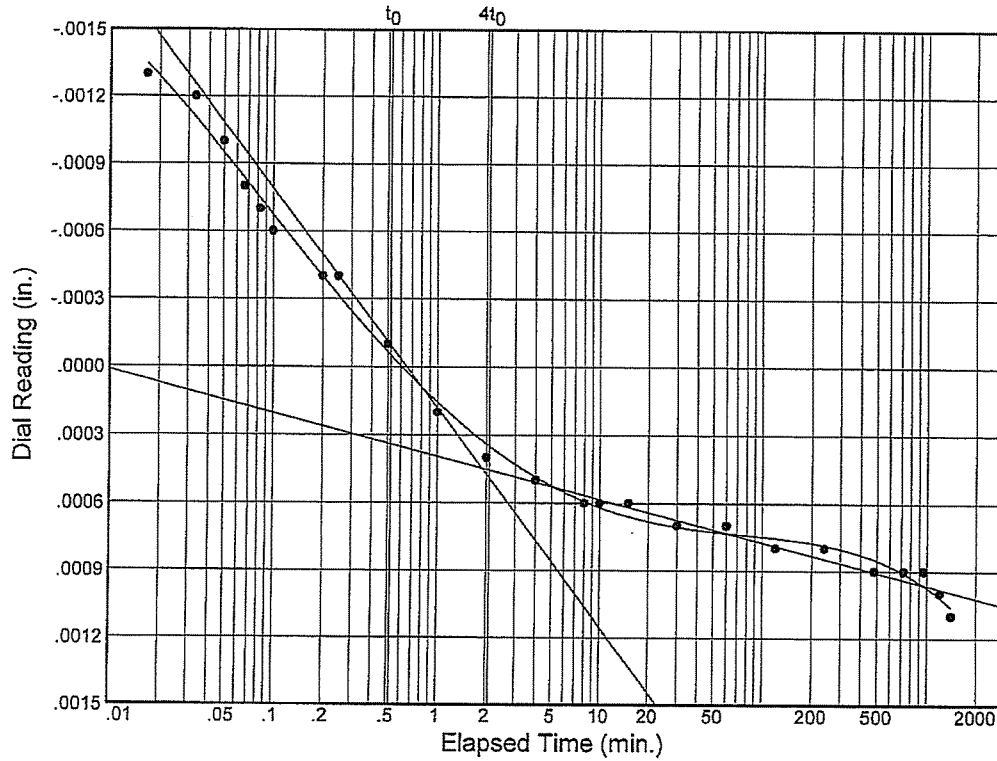

Load No.= 1
 Load= 0.49 tsf
 $D_0 = -0.00045$
 $D_{50} = 0.00000$
 $D_{100} = 0.00045$
 $T_{50} = 0.60 \text{ min.}$

$C_v @ T_{50}$
 0.0009 in.²/sec.

$C_\alpha = 0.000$

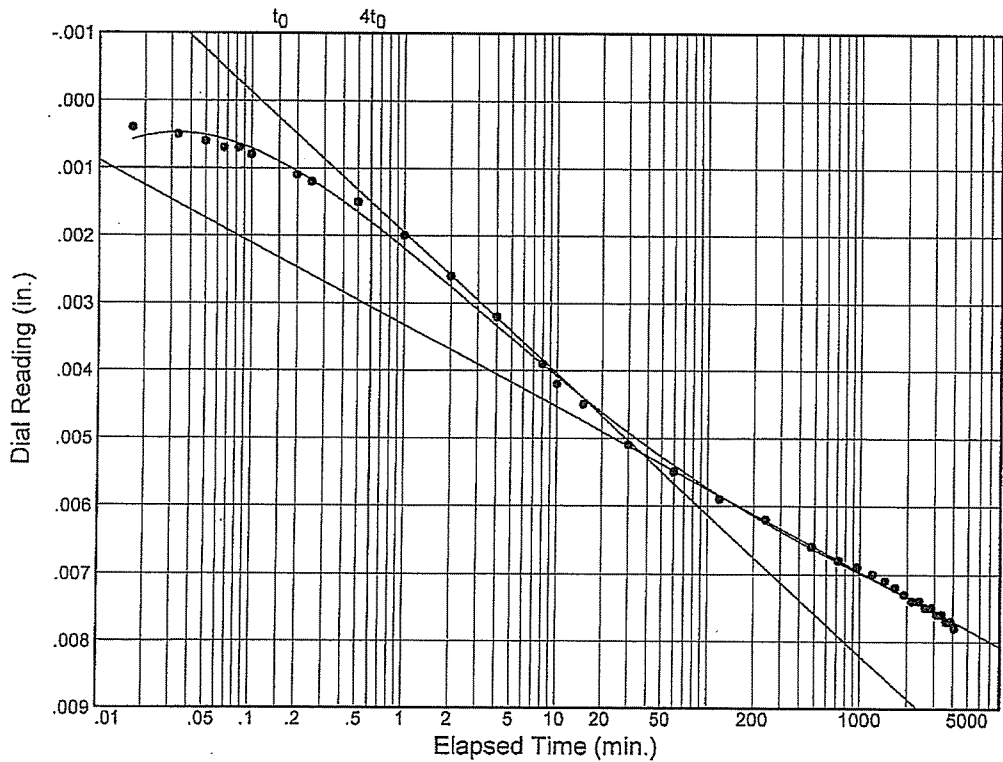

Load No.= 2
 Load= 0.97 tsf
 $D_0 = 0.00000$
 $D_{50} = 0.00261$
 $D_{100} = 0.00522$
 $T_{50} = 1.68 \text{ min.}$

$C_v @ T_{50}$
 0.0003 in.²/sec.

$C_\alpha = 0.002$

Dial Reading vs. Time

Project No.: 20749
 Project: FRANKLIN CANAL FLOODGATE AND LEVEE

Source: B-1

Sample No.: 8

Elev./Depth: 109.0'

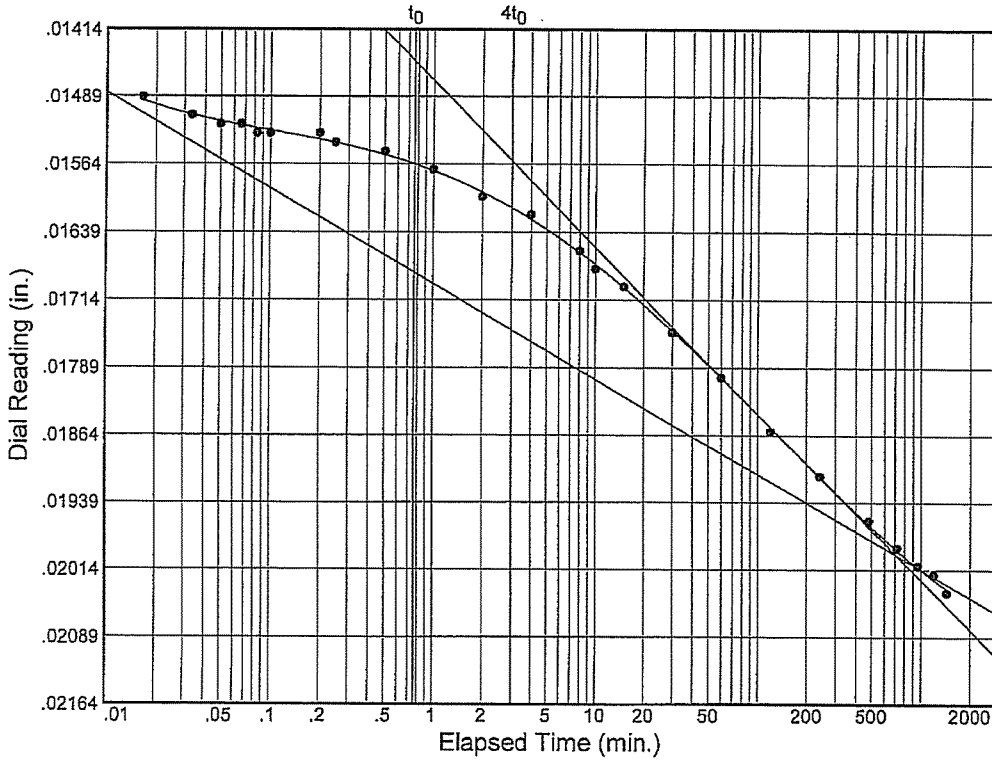

Load No.= 3
 Load= 1.93 tsf
 $D_0 = 0.01515$
 $D_{50} = 0.01757$
 $D_{100} = 0.01998$
 $T_{50} = 33.62$ min.

$C_v @ T_{50}$
 0.0000 in.²/sec.

$C_\alpha = 0.001$

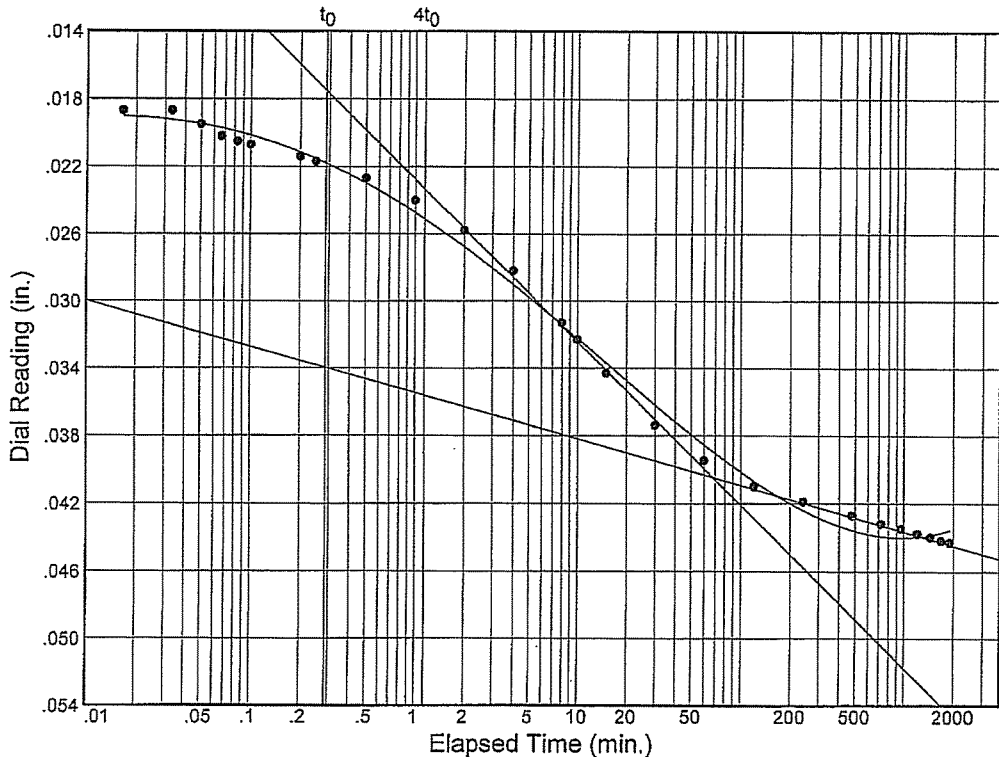

Load No.= 4
 Load= 3.85 tsf
 $D_0 = 0.01849$
 $D_{50} = 0.02948$
 $D_{100} = 0.04046$
 $T_{50} = 4.59$ min.

$C_v @ T_{50}$
 0.0001 in.²/sec.

$C_\alpha = 0.004$

Dial Reading vs. Time

Project No.: 20749
 Project: FRANKLIN CANAL FLOODGATE AND LEVEE

Source: B-1

Sample No.: 8

Elev./Depth: 109.0'

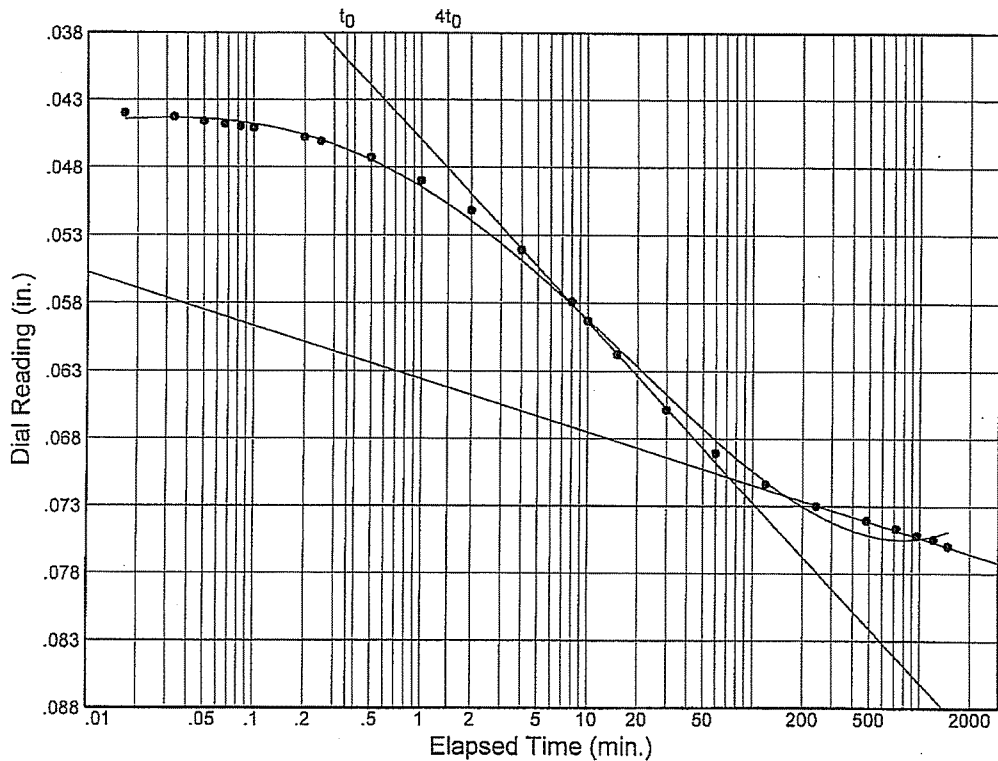

Load No.= 5

Load= 7.69 tsf

$D_0 = 0.04271$

$D_{50} = 0.05682$

$D_{100} = 0.07093$

$T_{50} = 6.11 \text{ min.}$

$C_v @ T_{50}$

0.0001 in.²/sec.

$C_\alpha = 0.005$

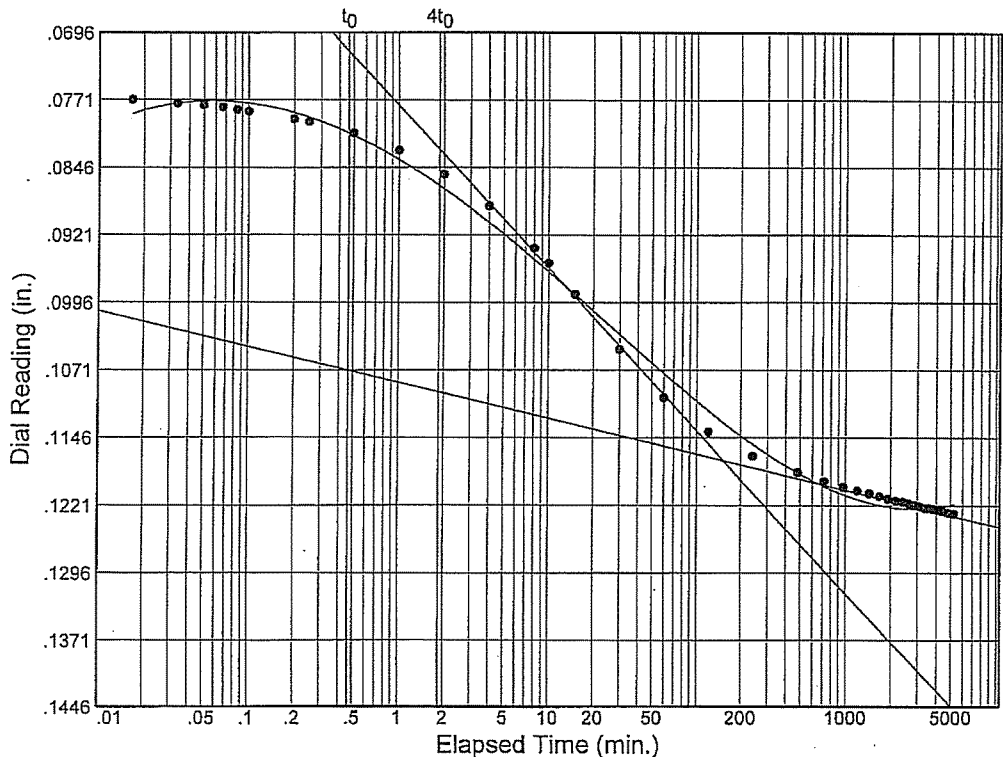

Load No.= 6

Load= 15.37 tsf

$D_0 = 0.07496$

$D_{50} = 0.09606$

$D_{100} = 0.11717$

$T_{50} = 9.78 \text{ min.}$

$C_v @ T_{50}$

0.0000 in.²/sec.

$C_\alpha = 0.006$

Dial Reading vs. Time

Project No.: 20749
 Project: FRANKLIN CANAL FLOODGATE AND LEVEE

Source: B-1

Sample No.: 8

Elev./Depth: 109.0'

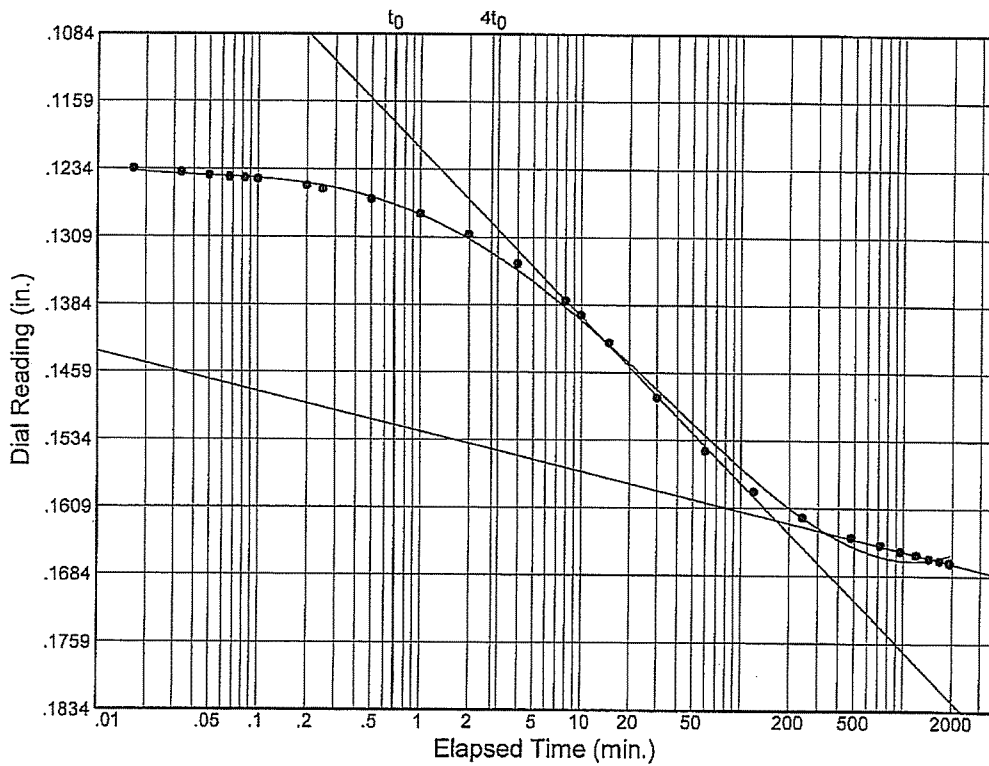

Load No.= 7
 Load= 30.73 tsf
 $D_0 = 0.12194$
 $D_{50} = 0.14212$
 $D_{100} = 0.16231$
 $T_{50} = 13.50 \text{ min.}$

$C_v @ T_{50}$
 $0.0000 \text{ in.}^2/\text{sec.}$

$C_\alpha = 0.007$

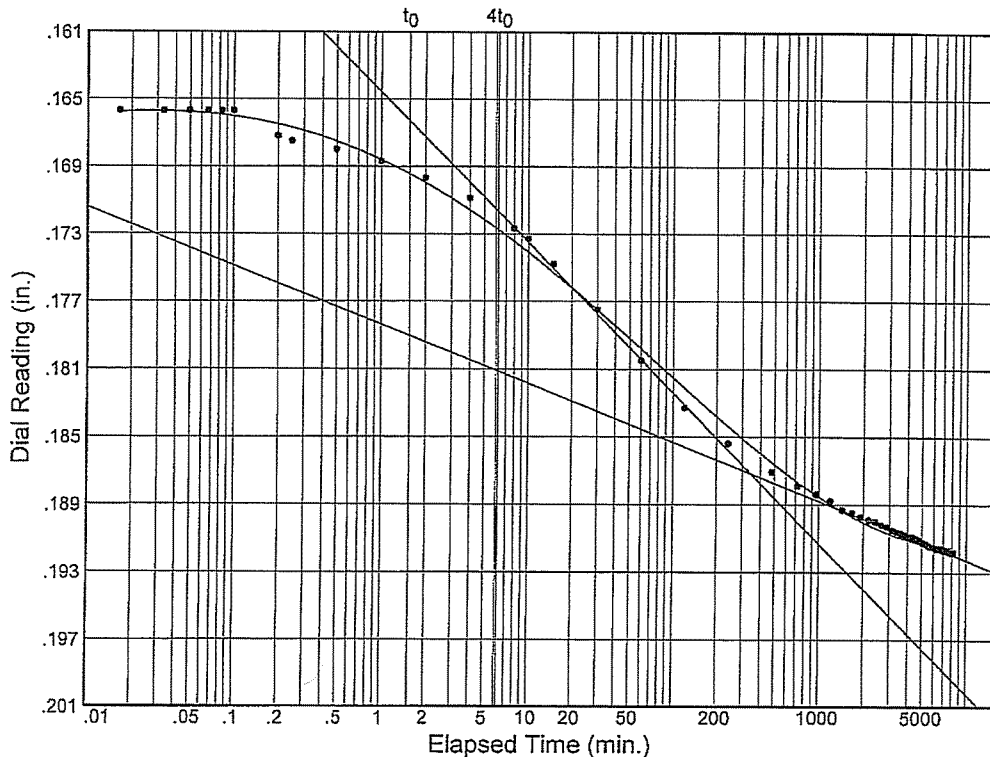

Load No.= 8
 Load= 45.21 tsf
 $D_0 = 0.16615$
 $D_{50} = 0.17666$
 $D_{100} = 0.18717$
 $T_{50} = 23.12 \text{ min.}$

$C_v @ T_{50}$
 $0.0000 \text{ in.}^2/\text{sec.}$

$C_\alpha = 0.006$

Dial Reading vs. Time

Project No.: 20749
 Project: FRANKLIN CANAL FLOODGATE AND LEVEE

Source: B-1

Sample No.: 8

Elev./Depth: 109.0'

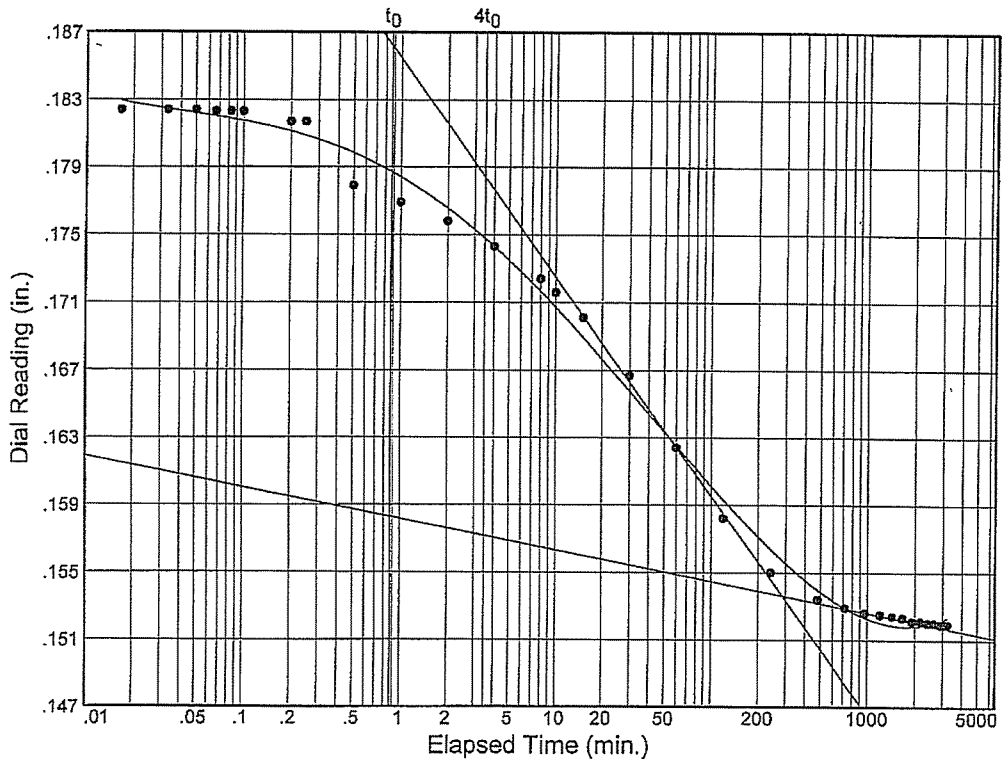
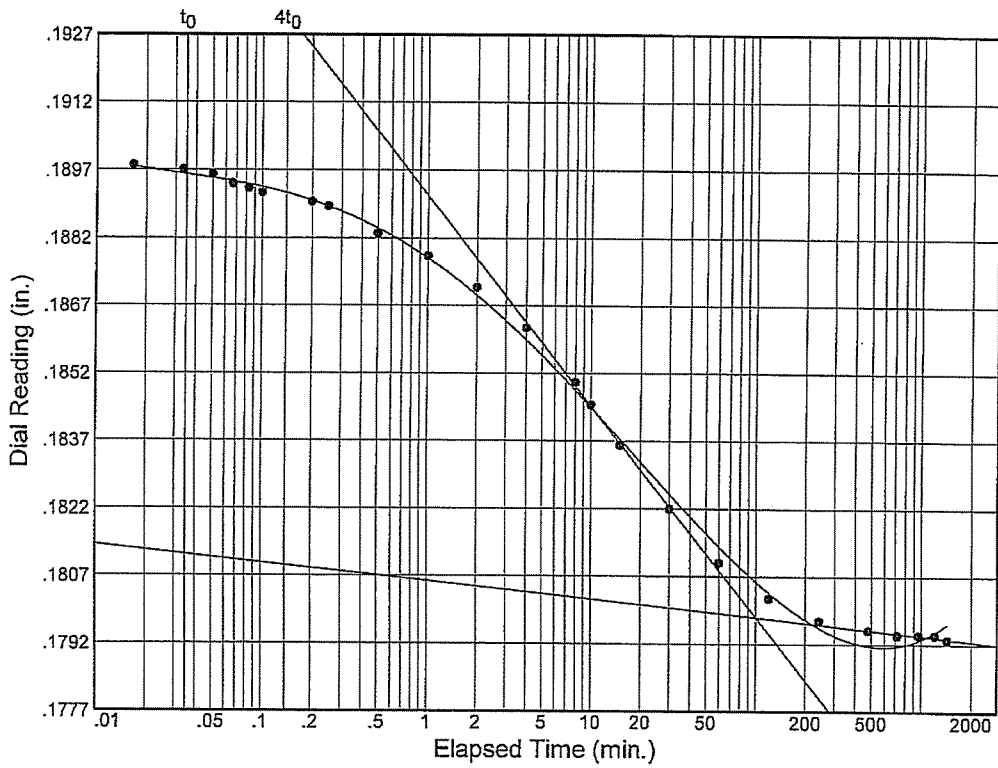

Dial Reading vs. Time

Project No.: 20749

Project: FRANKLIN CANAL FLOODGATE AND LEVEE

Source: B-1

Sample No.: 8

Elev./Depth: 109.0'

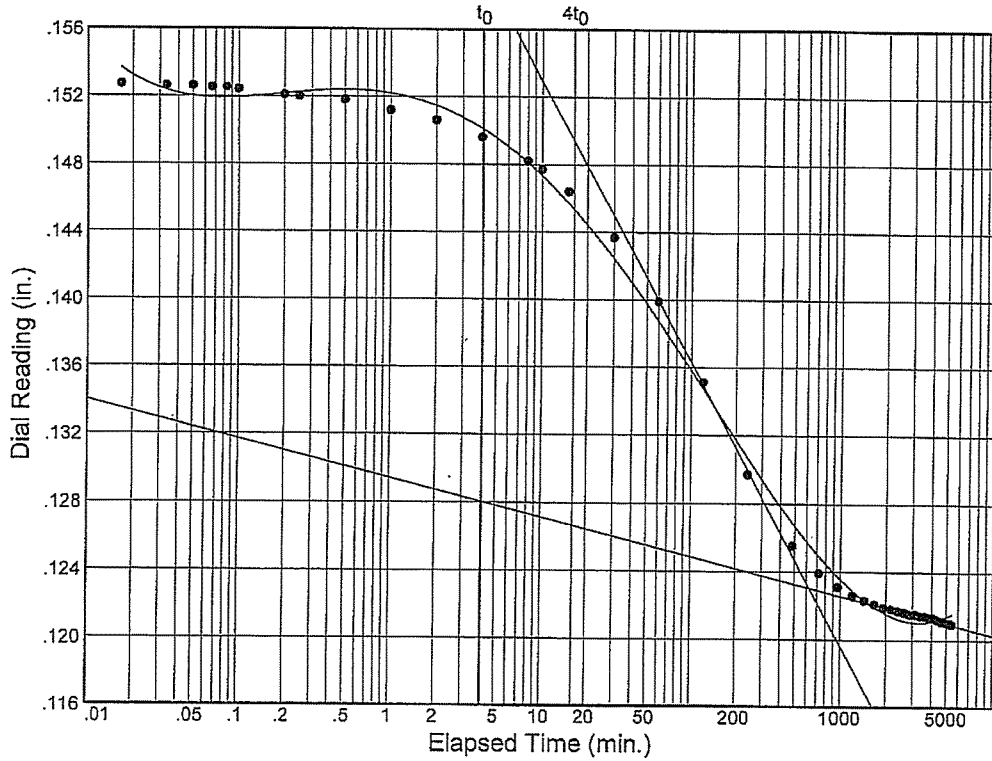

CONSOLIDATION TEST REPORT

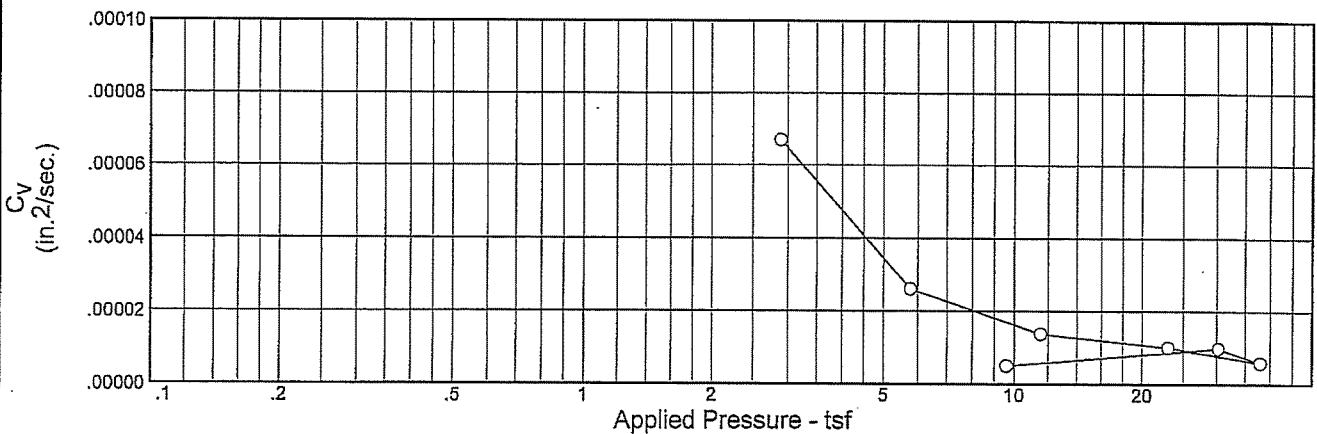
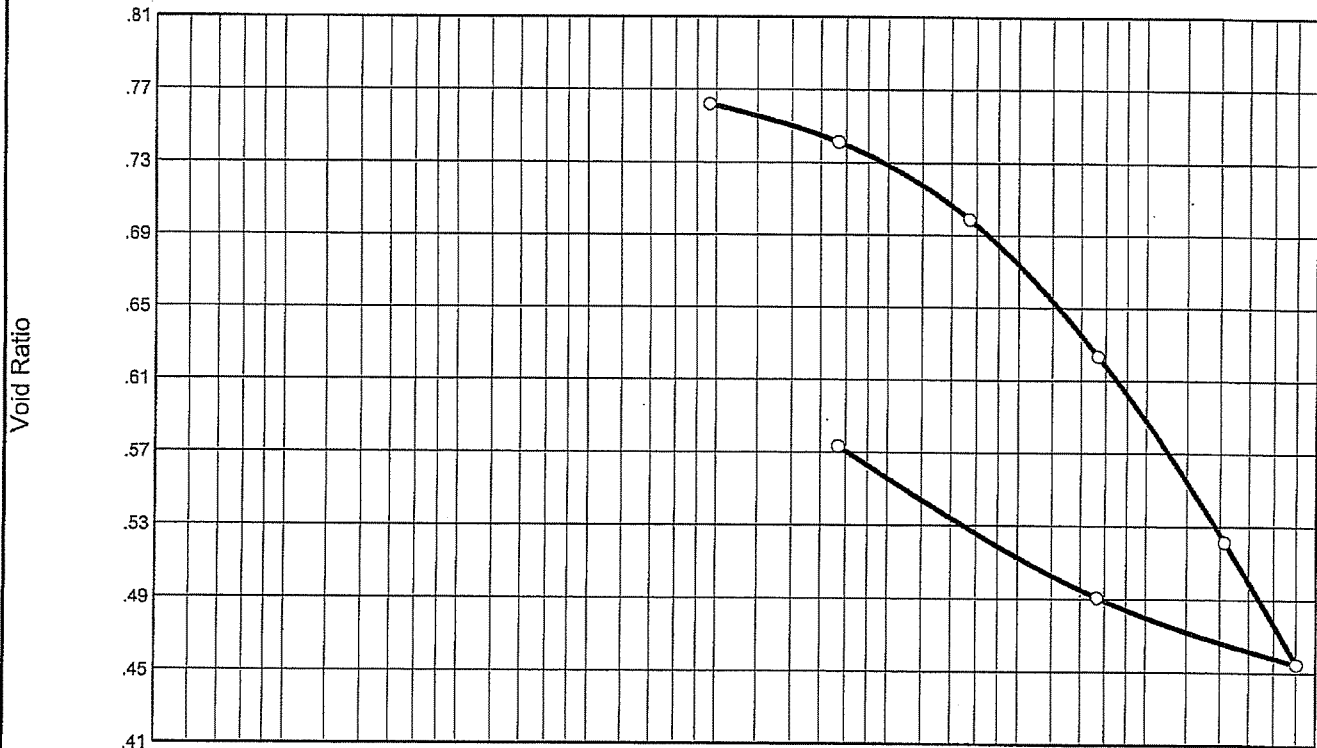

Natural		Dry Dens. (pcf)	LL	PI	Sp. Gr.	P _c (tsf)	C _c	Initial Void Ratio
Saturation	Moisture							
100.0 %	29.2 %	94.4	63	41	2.72	9.77	0.40	0.794

MATERIAL DESCRIPTION		USCS	AASHTO
VST GRN-GR & T CL W/ SI POC		CH	

Project No. 20749 **Client:**
Project: FRANKLIN CANAL FLOODGATE AND LEVEE
Source: B-1 **Sample No.:** 12 **Elev./Depth:** 129.0'

Remarks:
 TESTED BY: RR
 CHECKED BY: RNE



Figure

Dial Reading vs. Time

Project No.: 20749

Project: FRANKLIN CANAL FLOODGATE AND LEVEE

Source: B-1

Sample No.: 12

Elev./Depth: 129.0'

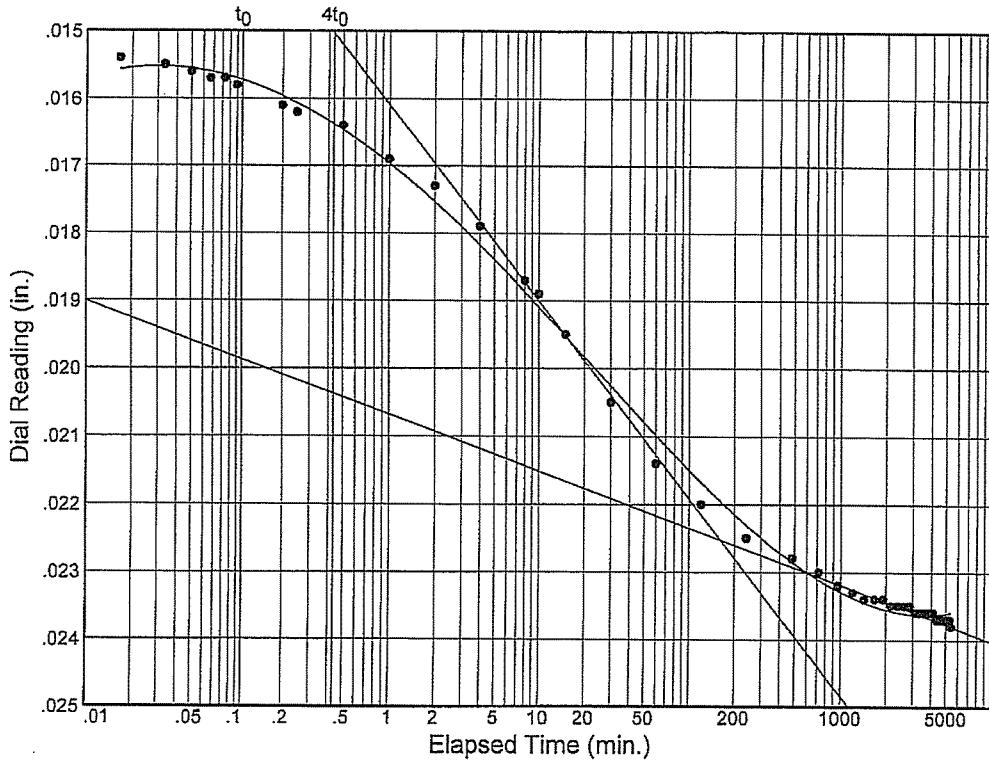

Load No.= 2
 Load= 3.85 tsf
 $D_0 = 0.01507$
 $D_{50} = 0.01880$
 $D_{100} = 0.02252$
 $T_{50} = 7.47$ min.

$C_v @ T_{50}$
 0.0001 in.²/sec.

$C_\alpha = 0.001$

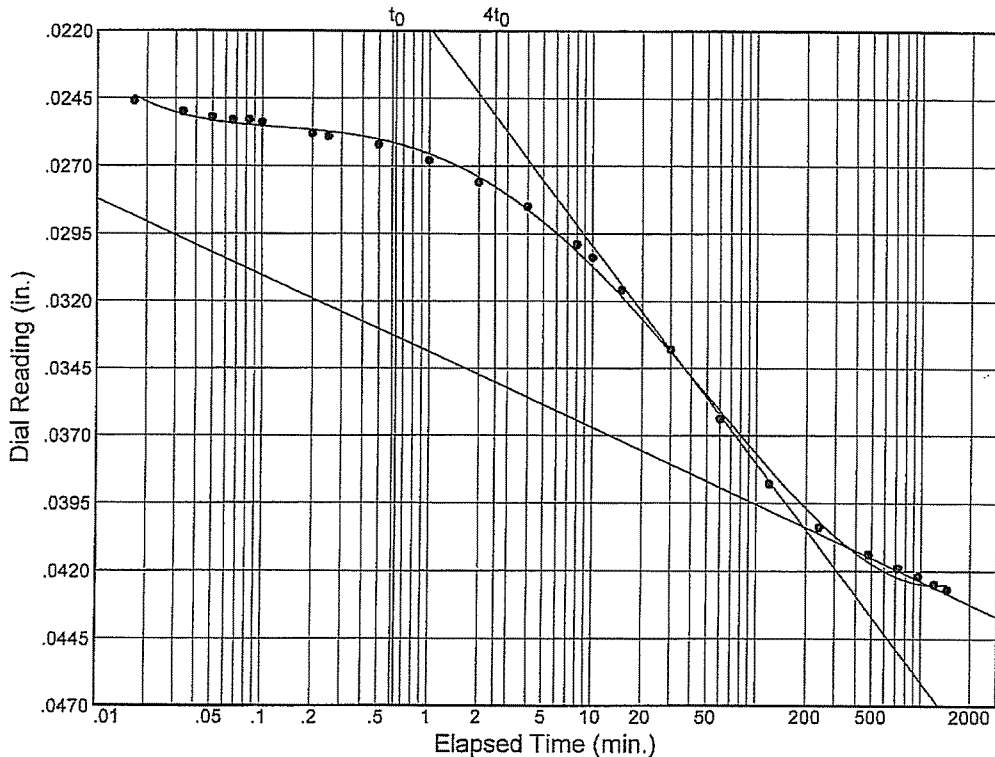

Load No.= 3
 Load= 7.69 tsf
 $D_0 = 0.02455$
 $D_{50} = 0.03246$
 $D_{100} = 0.04036$
 $T_{50} = 18.57$ min.

$C_v @ T_{50}$
 0.0000 in.²/sec.

$C_\alpha = 0.004$

Dial Reading vs. Time

Project No.: 20749
 Project: FRANKLIN CANAL FLOODGATE AND LEVEE

Source: B-1

Sample No.: 12

Elev./Depth: 129.0'

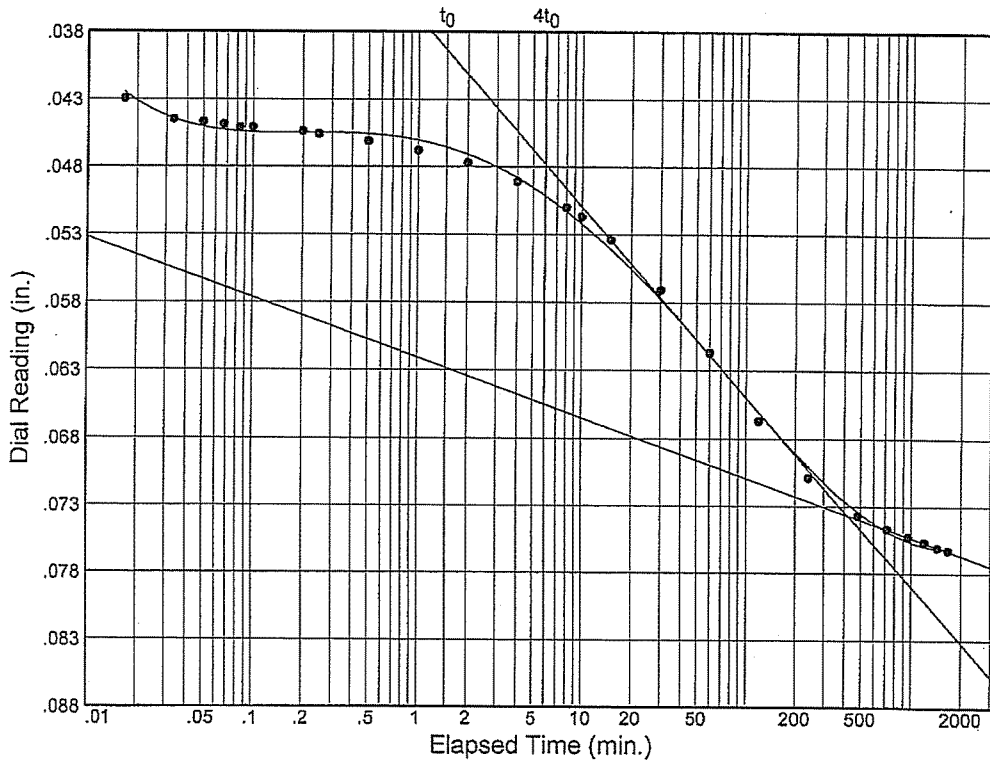

Load No.= 4
 Load= 15.37 tsf
 $D_0 = 0.04298$
 $D_{50} = 0.05833$
 $D_{100} = 0.07368$
 $T_{50} = 32.95 \text{ min.}$

$C_v @ T_{50}$
 0.0000 in.²/sec.

$C_\alpha = 0.006$

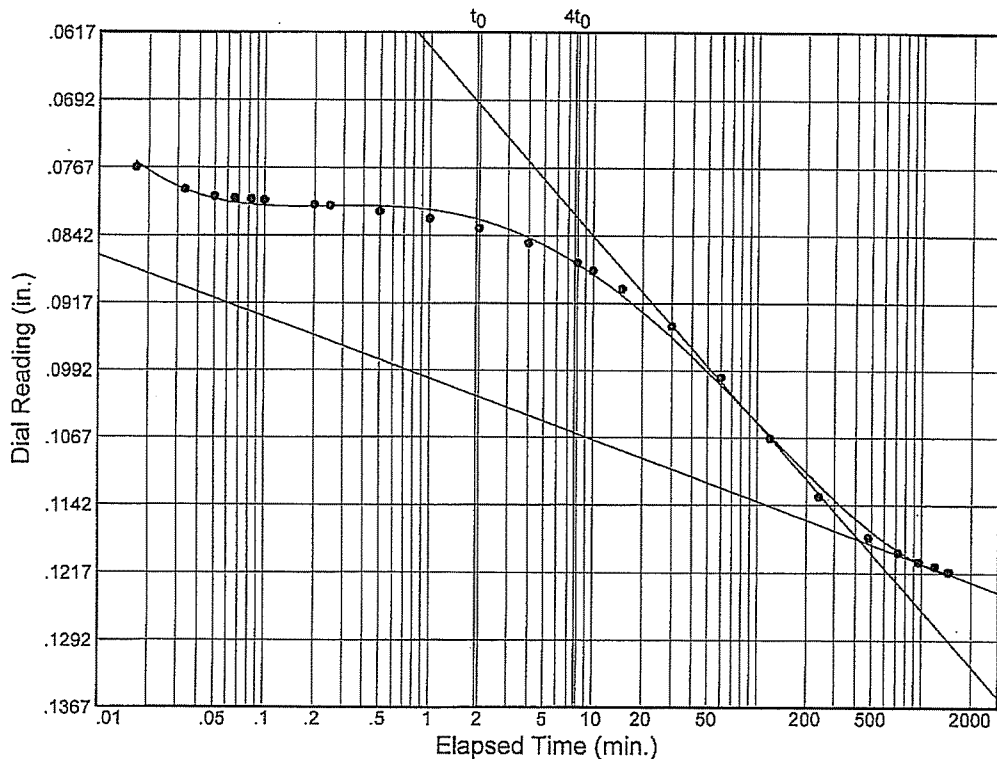

Load No.= 5
 Load= 30.73 tsf
 $D_0 = 0.07750$
 $D_{50} = 0.09779$
 $D_{100} = 0.11808$
 $T_{50} = 40.47 \text{ min.}$

$C_v @ T_{50}$
 0.0000 in.²/sec.

$C_\alpha = 0.009$

Dial Reading vs. Time

Project No.: 20749
 Project: FRANKLIN CANAL FLOODGATE AND LEVEE

Source: B-1

Sample No.: 12

Elev./Depth: 129.0'

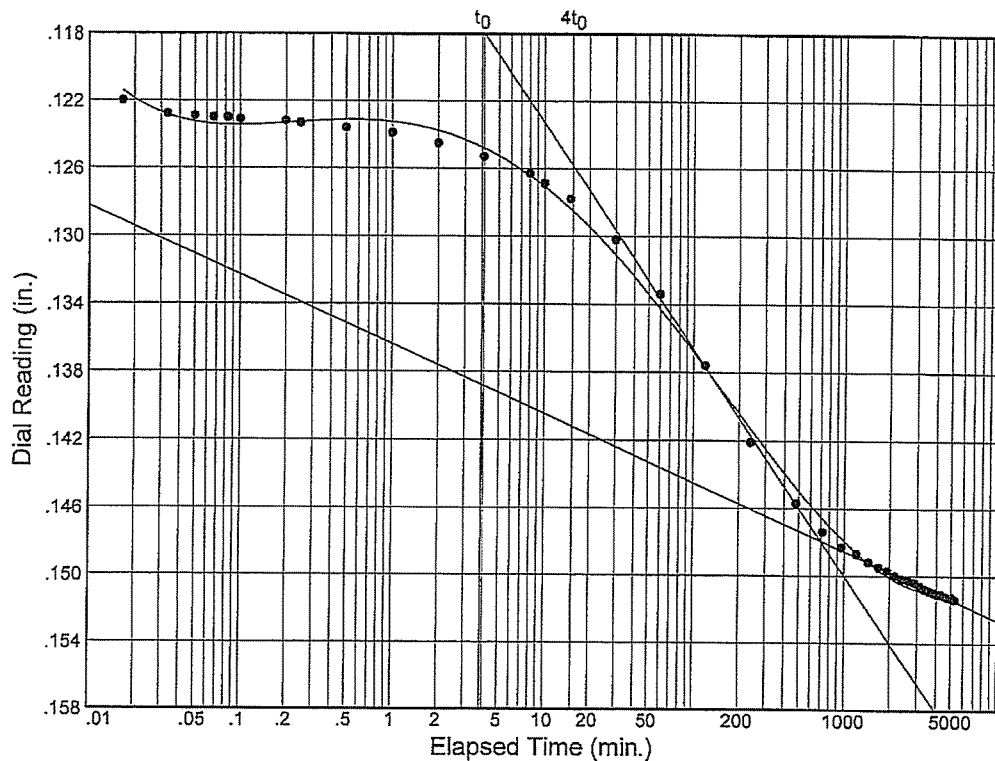

Load No.= 6
 Load= 45.21 tsf
 $D_0 = 0.12095$
 $D_{50} = 0.13444$
 $D_{100} = 0.14793$
 $T_{50} = 61.95 \text{ min.}$

$C_v @ T_{50}$
 0.0000 in.²/sec.

$C_\alpha = 0.006$

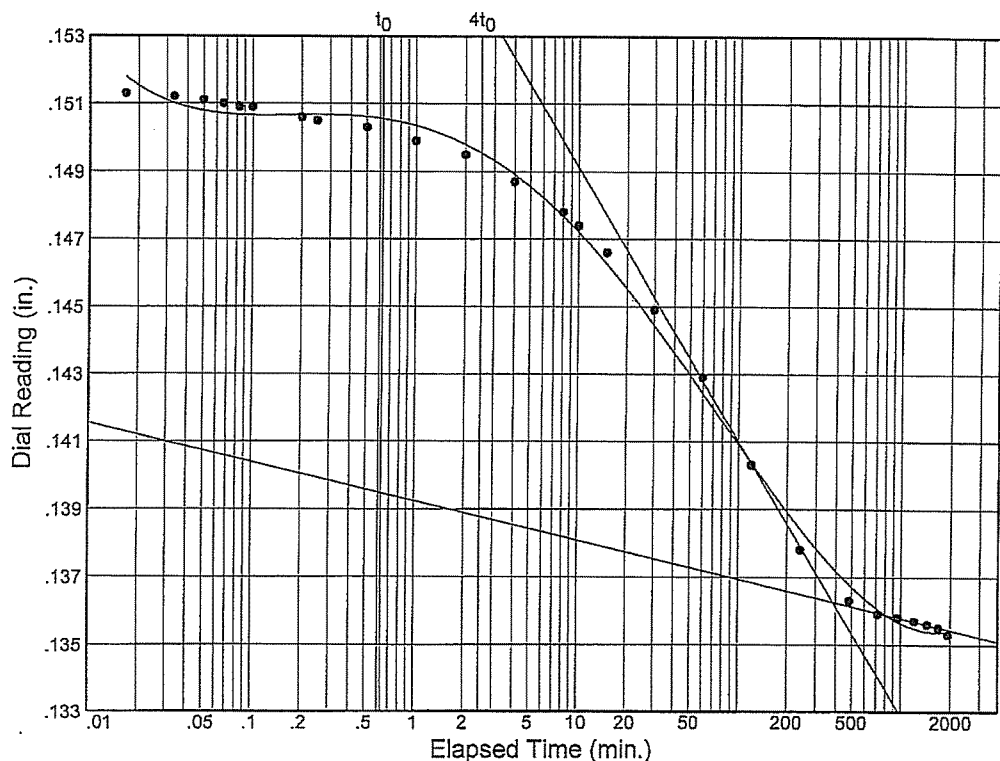

Load No.= 7
 Load= 15.37 tsf
 $D_0 = 0.15157$
 $D_{50} = 0.14392$
 $D_{100} = 0.13626$
 $T_{50} = 36.18 \text{ min.}$

$C_v @ T_{50}$
 0.0000 in.²/sec.

Dial Reading vs. Time

Project No.: 20749
 Project: FRANKLIN CANAL FLOODGATE AND LEVEE

Source: B-I

Sample No.: 12

Elev./Depth: 129.0'

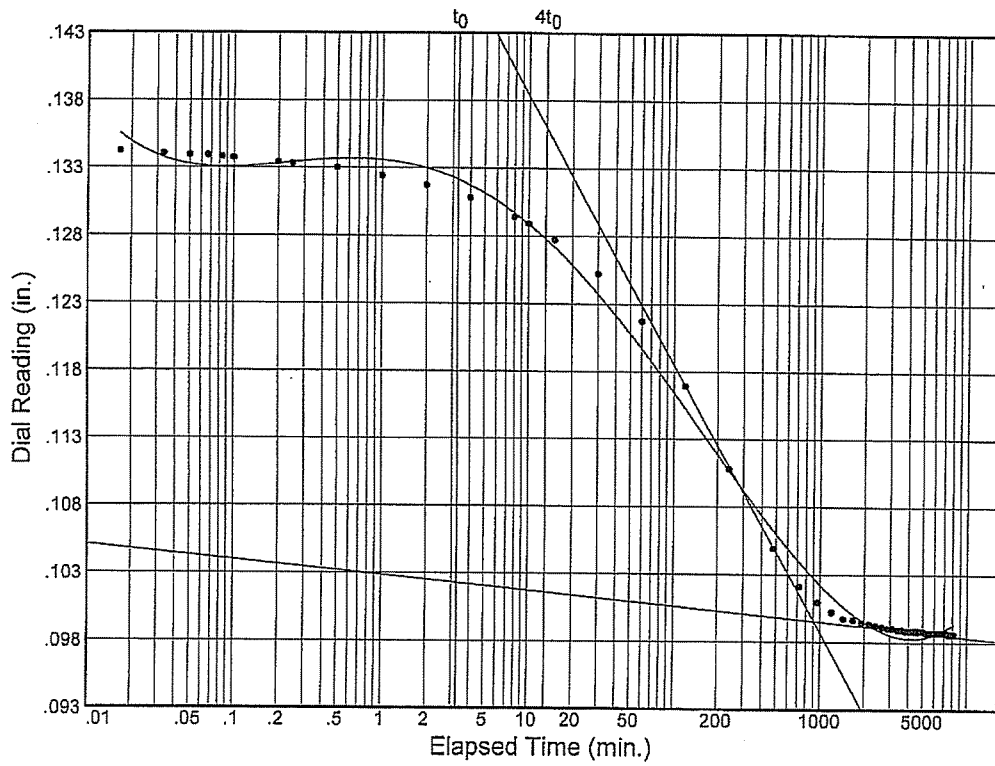

APPENDIX III
HORIZONTAL SOIL REACTION AND
LATERAL PILE DEFLECTION (p-y) CURVES

24 inch square precast concrete pile - stratum 1 through 4.lpo

LPILE Plus for Windows, Version 5.0 (5.0.30)

Analysis of Individual Piles and Drilled Shafts
Subjected to Lateral Loading Using the p-y Method

(c) 1985-2007 by Ensoft, Inc.
All Rights Reserved

This program is licensed to:

DJI
Eustis

Path to file locations: U:\sys\WPDATA\Projects\20749\Piles\LPile\
Name of input data file: 24 inch square precast concrete pile - stratum 1
through 4.lpd
Name of output file: 24 inch square precast concrete pile - stratum 1
through 4.lpo
Name of plot output file: 24 inch square precast concrete pile - stratum 1
through 4.lpp
Name of runtime file: 24 inch square precast concrete pile - stratum 1
through 4.lpr

Time and Date of Analysis

Date: November 10, 2009 Time: 8:16:54

Problem Title

EE20749 - St. Mary Floodgate Structure at Franklin Drainage Canal

Program Options

Units Used in Computations - US Customary Units: Inches, Pounds

Basic Program Options:

Analysis Type 1:

- Computation of Lateral Pile Response Using User-specified Constant EI

Computation Options:

- Only internally-generated p-y curves used in analysis
- Analysis does not use p-y multipliers (individual pile or shaft action only)
- Analysis assumes no shear resistance at pile tip
- Analysis for fixed-length pile or shaft only
- No computation of foundation stiffness matrix elements
- Output pile response for full length of pile
- Analysis assumes no soil movements acting on pile
- Additional p-y curves computed at specified depths

24 inch square precast concrete pile - stratum 1 through 4.lpo

Solution Control Parameters:

- Number of pile increments = 100
- Maximum number of iterations allowed = 100
- Deflection tolerance for convergence = 1.0000E-05 in
- Maximum allowable deflection = 1.0000E+02 in

Printing Options:

- Values of pile-head deflection, bending moment, shear force, and soil reaction are printed for full length of pile.
- Printing Increment (spacing of output points) = 1

Pile Structural Properties and Geometry

- Pile Length = 1690.00 in
- Depth of ground surface below top of pile = .00 in
- Slope angle of ground surface = .00 deg.

Structural properties of pile defined using 2 points

Point	Depth X in	Pile Diameter in	Moment of Inertia in**4	Pile Area Sq.in	Modulus of Elasticity lbs/Sq.in
1	0.0000	24.00000000	27648.0000	576.0000	3604997.
2	1690.0000	24.00000000	27648.0000	576.0000	3604997.

Soil and Rock Layering Information

The soil profile is modelled using 10 layers

Layer 1 is silt with cohesion and friction

- Distance from top of pile to top of layer = .000 in
- Distance from top of pile to bottom of layer = 36.000 in
- p-y subgrade modulus k for top of soil layer = 55.600 lbs/in**3
- p-y subgrade modulus k for bottom of layer = 55.600 lbs/in**3

Layer 2 is soft clay, p-y criteria by Matlock, 1970

- Distance from top of pile to top of layer = 36.000 in
- Distance from top of pile to bottom of layer = 180.000 in

Layer 3 is silt with cohesion and friction

- Distance from top of pile to top of layer = 180.000 in
- Distance from top of pile to bottom of layer = 204.000 in
- p-y subgrade modulus k for top of soil layer = 55.600 lbs/in**3
- p-y subgrade modulus k for bottom of layer = 55.600 lbs/in**3

Layer 4 is soft clay, p-y criteria by Matlock, 1970

- Distance from top of pile to top of layer = 204.000 in
- Distance from top of pile to bottom of layer = 276.000 in

Layer 5 is soft clay, p-y criteria by Matlock, 1970

- Distance from top of pile to top of layer = 276.000 in
- Distance from top of pile to bottom of layer = 516.000 in

Layer 6 is stiff clay without free water

- Distance from top of pile to top of layer = 516.000 in

24 inch square precast concrete pile - stratum 1 through 4.1po
 Distance from top of pile to bottom of layer = 612.000 in

Layer 7 is stiff clay without free water
 Distance from top of pile to top of layer = 612.000 in
 Distance from top of pile to bottom of layer = 828.000 in

Layer 8 is stiff clay without free water
 Distance from top of pile to top of layer = 828.000 in
 Distance from top of pile to bottom of layer = 1212.000 in

Layer 9 is stiff clay without free water
 Distance from top of pile to top of layer = 1212.000 in
 Distance from top of pile to bottom of layer = 1356.000 in

Layer 10 is stiff clay without free water
 Distance from top of pile to top of layer = 1356.000 in
 Distance from top of pile to bottom of layer = 1692.000 in

(Depth of lowest layer extends 2.00 in below pile tip)

 Effective Unit Weight of Soil vs. Depth

Distribution of effective unit weight of soil with depth
 is defined using 20 points

Point No.	Depth X in	Eff. Unit weight lbs/in**3
1	.00	.03160
2	36.00	.03160
3	36.00	.03330
4	180.00	.03330
5	180.00	.03160
6	204.00	.03160
7	204.00	.03480
8	276.00	.03480
9	276.00	.03250
10	516.00	.03250
11	516.00	.03620
12	612.00	.03620
13	612.00	.03550
14	828.00	.03550
15	828.00	.03110
16	1212.00	.03110
17	1212.00	.03040
18	1356.00	.03040
19	1356.00	.03450
20	1692.00	.03450

 Shear Strength of Soils

Distribution of shear strength parameters with depth
 defined using 20 points

Point	Depth X	Cohesion c	Angle of Friction	E50 or	RQD
-------	---------	------------	-------------------	--------	-----

No.	24 inch square precast concrete pile - stratum 1 through 4.1po in	lbs/in**2	Deg.	k_rm	%
1	.000	1.38890	15.00	.02000	.0
2	36.000	1.38890	15.00	.02000	.0
3	36.000	2.20140	.00	.02000	.0
4	180.000	2.20140	.00	.02000	.0
5	180.000	1.38890	15.00	.02000	.0
6	204.000	1.38890	15.00	.02000	.0
7	204.000	3.12500	.00	.02000	.0
8	276.000	3.12500	.00	.02000	.0
9	276.000	4.16670	.00	.01000	.0
10	516.000	7.63890	.00	.00700	.0
11	516.000	7.63890	.00	.00700	.0
12	612.000	7.63890	.00	.00700	.0
13	612.000	9.59030	.00	.00700	.0
14	828.000	9.59030	.00	.00700	.0
15	828.000	7.84720	.00	.00700	.0
16	1212.000	7.84720	.00	.00700	.0
17	1212.000	10.59030	.00	.00700	.0
18	1356.000	10.59030	.00	.00700	.0
19	1356.000	14.34720	.00	.00500	.0
20	1692.000	14.34720	.00	.00500	.0

Notes:

- (1) Cohesion = uniaxial compressive strength for rock materials.
- (2) Values of E50 are reported for clay strata.
- (3) Default values will be generated for E50 when input values are 0.
- (4) RQD and k_rm are reported only for weak rock strata.

Loading Type

Cyclic loading criteria was used for computation of p-y curves

Number of cycles of loading = 1000.

Pile-head Loading and Pile-head Fixity Conditions

Number of loads specified = 1

Load Case Number 1

Pile-head boundary conditions are Shear and Moment (BC Type 1)

Shear force at pile head = 1000.000 lbs
 Bending moment at pile head = 1000.000 in-lbs
 Axial load at pile head = 1000.000 lbs

Non-zero moment at pile head for this load case indicates the pile-head may rotate under the applied pile-head loading, but is not a free-head (zero moment) condition.

24 inch square precast concrete pile - stratum 1 through 4.lpo

Output of p-y Curves at Specified Depths

p-y curves are generated and printed for verification at 8 depths.

Depth No.	Depth Below Pile Head in	Depth Below Ground Surface in
1	18.000	18.000
2	48.000	48.000
3	108.000	108.000
4	168.000	168.000
5	192.000	192.000
6	216.000	216.000
7	240.000	240.000
8	264.000	264.000

Depth of ground surface below top of pile = .00 in

Eq. 3.65	19.7072
Eq. 3.66	63.0615
Eq. 3.67	3.7845
Eq. 3.67	126.1521
Eq. 3.69	145.8593
Eq. 3.75	-3.7500
Eq. 3.76	171.3594
Eq. 3.77	.2483

p-y Curve Computed Using the Cyclic Criteria for Cemented Silt

Soil Layer Number	=	1
Depth below pile head	=	18.000 in
Depth below ground surface	=	18.000in
Equivalent Depth	=	18.000in
Pile Diameter	=	24.000in
Cohesion, c	=	1.389lbs/in**2
Angle of Friction	=	15.000 deg.
Avg. Eff. Unit Weight	=	.03160lbs/in**3
k (internal default)	=	55.600lbs/in**3
E50 (internal default)	=	.02000
A parameter	=	1.00000
B parameter	=	.77500
Pu	=	126.152lbs/in
Pc	=	19.707lbs/in
Number of Cycles of Loading	=	1000.
p-multiplier	=	1.00000
y-multiplier	=	1.00000
Pu,c	=	126.152lbs/in
Pc,phi	=	19.707lbs/in

y, in	p, lbs/in
0.0000	0.0000
.0333333	33.3600
.0666667	66.7200
.1000000	100.0800
.1333333	133.4400
.1666667	166.8000
.2000000	200.1600
.2333333	233.5200

24 inch square precast concrete pile - stratum 1 through 4.1po

.2666667	243.7715
.3000000	236.2340
.3333333	229.6891
.3666667	223.9248
.4000000	218.7889
.9000000	145.8593
24.9000	145.8593
48.9000	145.8593
72.9000	145.8593

p-y Curve Computed Using the Soft Clay Criteria for Cyclic Loading Conditions

Soil Layer Number	=	2
Depth below pile head	=	48.000 in
Depth below ground surface	=	48.000 in
Equivalent Depth	=	40.915 in
Pile Diameter	=	24.000 in
Cohesion, c	=	2.201 lbs/in**2
Avg Eff Unit Weight	=	.03203 lbs/in**3
E50 parameter	=	.02000
Default J parameter	=	.500
Y50	=	1.20000 in
p-multiplier	=	1.00000
y-multiplier	=	1.00000
Number of cycles of loading	=	1000.
Xr	=	169.583 in

y, in	p, lbs/in
0.0000	0.0000
.0096000	24.8227
.3000000	78.1867
.6000000	98.5090
.9000000	112.7647
1.2000	124.1136
1.5000	133.6973
1.8000	142.0746
2.1000	149.5657
2.4000	156.3733
2.7000	162.6348
3.0000	168.4481
3.3000	173.8856
3.6000	179.0028
9.6000	122.2221
18.0000	43.1200
24.0000	43.1200

p-y Curve Computed Using the Soft Clay Criteria for Cyclic Loading Conditions

Soil Layer Number	=	2
Depth below pile head	=	108.000 in
Depth below ground surface	=	108.000 in
Equivalent Depth	=	100.915 in
Pile Diameter	=	24.000 in
Cohesion, c	=	2.201 lbs/in**2
Avg Eff Unit Weight	=	.03273 lbs/in**3
E50 parameter	=	.02000
Default J parameter	=	.500

24 inch square precast concrete pile - stratum 1 through 4.1po

Y50 = 1.20000 in
 p-multiplier = 1.00000
 y-multiplier = 1.00000
 Number of cycles of loading = 1000.
 Xr = 168.055 in

y, in	p, lbs/in
0.0000	0.0000
.0096000	36.2221
.3000000	114.0925
.6000000	143.7476
.9000000	164.5499
1.2000	181.1106
1.5000	195.0955
1.8000	207.3199
2.1000	218.2512
2.4000	228.1851
2.7000	237.3220
3.0000	245.8049
3.3000	253.7395
3.6000	261.2067
9.6000	217.3857
18.0000	156.6067
24.0000	156.6067

p-y Curve Computed Using the Soft Clay Criteria for Cyclic Loading Conditions

Soil Layer Number = 2
 Depth below pile head = 168.000 in
 Depth below ground surface = 168.000 in
 Equivalent Depth = 160.915 in
 Pile Diameter = 24.000 in
 Cohesion, c = 2.201 lbs/in**2
 Avg Eff Unit Weight = .03294 lbs/in**3
 E50 parameter = .02000
 Default J parameter = .500
 Y50 = 1.20000 in
 p-multiplier = 1.00000
 y-multiplier = 1.00000
 Number of cycles of loading = 1000.
 Xr = 167.623 in

y, in	p, lbs/in
0.0000	0.0000
.0096000	47.5502
.3000000	149.7739
.6000000	188.7033
.9000000	216.0113
1.2000	237.7512
1.5000	256.1097
1.8000	272.1572
2.1000	286.5071
2.4000	299.5477
2.7000	311.5422
3.0000	322.6780
3.3000	333.0941
3.6000	342.8966
9.6000	336.6528
18.0000	328.6602
24.0000	328.6602

24 inch square precast concrete pile - stratum 1 through 4.1po

Eq. 3.65 585.1394
 Eq. 3.66 699.7964
 Eq. 3.67 10.6652
 Eq. 3.68 300.0024
 Eq. 3.69 814.9250
 Eq. 3.75 -3.2365
 Eq. 3.76 1000.3467
 Eq. 3.77 .1780

p-y Curve Computed Using the Cyclic Criteria for Cemented Silt

Soil Layer Number = 3
 Depth below pile head = 192.000 in
 Depth below ground surface = 192.000in
 Equivalent Depth = 172.239in
 Pile Diameter = 24.000in
 Cohesion, c = 1.389lbs/in**2
 Angle of Friction = 15.000 deg.
 Avg. Eff. Unit Weight = .03288lbs/in**3
 k (internal default) = 55.600lbs/in**3
 E50 (internal default) = .02000
 A parameter = .88000
 B parameter = .55000
 Pu = 300.002lbs/in
 Pc = 585.139lbs/in
 Number of Cycles of Loading = 1000.
 p-multiplier = 1.00000
 y-multiplier = 1.00000
 Pu,c = 300.002lbs/in
 Pc,phi = 585.139lbs/in

y, in	p, lbs/in
0.0000	0.0000
.0333333	319.2168
.0666667	638.4336
.1000000	957.6504
.1333333	1276.8672
.1666667	1596.0840
.2000000	1644.8066
.2333333	1568.3030
.2666667	1504.9147
.3000000	1451.1324
.3333333	1404.6532
.3666667	1363.8915
.4000000	1327.7126
.9000000	814.9250
24.9000	814.9250
48.9000	814.9250
72.9000	814.9250

p-y Curve Computed Using the Soft Clay Criteria for Cyclic Loading Conditions

Soil Layer Number = 4
 Depth below pile head = 216.000 in
 Page 8

24 inch square precast concrete pile - stratum 1 through 4.1po

```

Depth below ground surface = 216.000 in
Equivalent Depth           = 293.038 in
Pile Diameter              = 24.000 in
Cohesion, c               = 3.125 lbs/in**2
Avg Eff Unit Weight        = .03291 lbs/in**3
E50 parameter              = .02000
Default J parameter        = .500
Y50                        = 1.20000 in
p-multiplier               = 1.00000
y-multiplier               = 1.00000
Number of cycles of loading = 1000.
Xr                          = 191.297 in

```

y, in	p, lbs/in
0.0000	0.0000
.0096000	67.5000
.3000000	212.6117
.6000000	267.8739
.9000000	306.6391
1.2000	337.5000
1.5000	363.5609
1.8000	386.3411
2.1000	406.7115
2.4000	425.2234
2.7000	442.2501
3.0000	458.0580
3.3000	472.8441
3.6000	486.7592
9.6000	486.0000
18.0000	486.0000
24.0000	486.0000

p-y Curve Computed Using the Soft Clay Criteria for Cyclic Loading Conditions

```

Soil Layer Number = 4
Depth below pile head = 240.000 in
Depth below ground surface = 240.000 in
Equivalent Depth = 317.038 in
Pile Diameter = 24.000 in
Cohesion, c = 3.125 lbs/in**2
Avg Eff Unit Weight = .03310 lbs/in**3
E50 parameter = .02000
Default J parameter = .500
Y50 = 1.20000 in
p-multiplier = 1.00000
y-multiplier = 1.00000
Number of cycles of loading = 1000.
Xr = 190.929 in

```

y, in	p, lbs/in
0.0000	0.0000
.0096000	67.5000
.3000000	212.6117
.6000000	267.8739
.9000000	306.6391
1.2000	337.5000
1.5000	363.5609
1.8000	386.3411
2.1000	406.7115
2.4000	425.2234

24 inch square precast concrete pile - stratum 1 through 4.lpo	
2.7000	442.2501
3.0000	458.0580
3.3000	472.8441
3.6000	486.7592
9.6000	486.0000
18.0000	486.0000
24.0000	486.0000

p-y Curve Computed Using the Soft Clay Criteria for Cyclic Loading Conditions

Soil Layer Number	=	4
Depth below pile head	=	264.000 in
Depth below ground surface	=	264.000 in
Equivalent Depth	=	341.038 in
Pile Diameter	=	24.000 in
Cohesion, c	=	3.125 lbs/in**2
Avg Eff Unit Weight	=	.03325 lbs/in**3
E50 parameter	=	.02000
Default J parameter	=	.500
Y50	=	1.20000 in
p-multiplier	=	1.00000
y-multiplier	=	1.00000
Number of cycles of loading	=	1000.
Xr	=	190.629 in

y, in	p, lbs/in
0.0000	0.0000
.0096000	67.5000
.3000000	212.6117
.6000000	267.8739
.9000000	306.6391
1.2000	337.5000
1.5000	363.5609
1.8000	386.3411
2.1000	406.7115
2.4000	425.2234
2.7000	442.2501
3.0000	458.0580
3.3000	472.8441
3.6000	486.7592
9.6000	486.0000
18.0000	486.0000
24.0000	486.0000

 Computed Values of Load Distribution and Deflection
 for Lateral Loading for Load Case Number 1

Pile-head boundary conditions are Shear and Moment (BC Type 1)	
Specified shear force at pile head	= 1000.000 lbs
Specified moment at pile head	= 1000.000 in-lbs
Specified axial load at pile head	= 1000.000 lbs

Non-zero moment for this load case indicates the pile-head may rotate under the applied pile-head loading, but is not a free-head (zero moment) condition.

Depth Es*h F/L in lbs/in	24 inch square precast concrete pile - stratum 1 through 4. lpo					
	Deflect.	Moment	Shear	Slope	Total	Soil Res.
	y	M	V	S	Stress	p
	in	lbs-in	lbs	Rad.	lbs/in**2	lbs/in
0.000	.006565	1000.0000	1000.0000	-7.1641E-05	2.1701	0.0000
0.0000						
16.900	.005356	17901.2093	957.4742	-7.0038E-05	9.5057	-5.0326
15879.9160						
33.800	.004198	33364.9938	848.2856	-6.5692E-05	16.2174	-7.8891
31759.8320						
50.700	.003136	46575.4818	634.0616	-5.8915E-05	21.9512	-17.4629
94121.8447						
67.600	.002207	54798.2666	338.5890	-5.0320E-05	25.5201	-17.5043
134062.						
84.500	.001435	58021.4900	48.0918	-4.0756E-05	26.9190	-16.8741
198767.						
101.400	.000829	56425.1477	-225.3167	-3.1053E-05	26.2262	-15.4820
315591.						
118.300	.000385	50406.8343	-451.4965	-2.1996E-05	23.6141	-11.2849
495215.						
135.200	8.56E-05	41165.3102	-569.8322	-1.4233E-05	19.6030	-2.7194
536862.						
152.100	-9.59E-05	31146.9882	-565.0581	-8.1020E-06	15.2548	3.2844
578509.						
169.000	-.000188	22066.6204	-479.2543	-3.5906E-06	11.3136	6.8699
616768.						
185.900	-.000217	14948.3136	-404.2413	-4.5248E-07	8.2241	2.0073
156111.						
202.800	-.000204	8403.2806	-369.7760	1.5272E-06	5.3834	2.0714
171991.						
219.700	-.000166	2449.8332	-279.7408	2.4474E-06	2.7994	8.5837
875533.						
236.600	-.000121	-1052.0398	-154.3195	2.5659E-06	2.1927	6.2591
875533.						
253.500	-7.90E-05	-2766.2529	-66.8640	2.2421E-06	2.9367	4.0907
875533.						
270.400	-4.50E-05	-3312.1191	-12.5845	1.7268E-06	3.1737	2.3329
875533.						
287.300	-2.06E-05	-3191.6665	22.9425	1.1754E-06	3.1214	1.8714
1535789.						
304.200	-5.30E-06	-2536.7016	43.0882	6.8980E-07	2.8371	.5126621
1634263.						
321.100	2.72E-06	-1735.3081	45.0600	3.2762E-07	2.4893	-.2793107
1734362.						
338.000	5.77E-06	-1013.6835	37.4005	9.4567E-08	2.1761	-.6271429
1836160.						
354.900	5.92E-06	-471.1742	26.3614	-3.1318E-08	1.9406	-.6792572
1939740.						
371.800	4.71E-06	-122.6663	15.8015	-8.1663E-08	1.7894	-.5704368
2045190.						
388.700	3.16E-06	62.9196	7.5825	-8.6728E-08	1.7634	-.4022229
2152606.						
405.600	1.78E-06	133.6263	2.1679	-7.0065E-08	1.7941	-.2385603
2262088.						
422.500	7.90E-07	136.1975	-.7851124	-4.7190E-08	1.7952	-.1109107
2373749.						
439.400	1.87E-07	107.0911	-1.9552	-2.6564E-08	1.7826	-.0275659
2487708.						
456.300	-1.08E-07	70.1113	-2.0473	-1.1541E-08	1.7665	.0166766

24 inch square precast concrete pile - stratum 1 through 4.lpo

2604096.						
473.200	-2.03E-07	37.8943	-1.6302	-2.3843E-09	1.7526	.0326791
2723054.						
490.100	-1.89E-07	15.0107	-1.0855	2.1010E-09	1.7426	.0317830
2844737.						
507.000	-1.32E-07	1.2046	-.6212443	3.4757E-09	1.7366	.0231576
2969314.						
523.900	-7.13E-08	-5.9874	-.2350657	3.0702E-09	1.7387	.0225440
5340698.						
540.800	-2.80E-08	-6.7407	.0302800	1.9911E-09	1.7390	.0088579
5340698.						
557.700	-4.04E-09	-4.9640	.1159103	9.9882E-10	1.7383	.0012759
5340698.						
574.600	5.73E-09	-2.8230	.1113894	3.3865E-10	1.7373	-.0018109
5340698.						
591.500	7.41E-09	-1.1991	.0763029	-2.3366E-12	1.7366	-.0023413
5340698.						
608.400	5.65E-09	-.2439170	.0414273	-1.2467E-10	1.7362	-.0017859
5340698.						
625.300	3.19E-09	.2011641	.0156249	-1.2830E-10	1.7362	-.0012676
6705010.						
642.200	1.31E-09	.2842073	.0005052	-8.7148E-11	1.7362	-.0005217
6705010.						
659.100	2.49E-10	.2182441	-.0047392	-4.4551E-11	1.7362	-9.8939E-05
6705010.						
676.000	-1.91E-10	.1240224	-.0049355	-1.5534E-11	1.7362	7.5713E-05
6705010.						
692.900	-2.76E-10	.0514248	-.0033716	-6.5930E-13	1.7361	.0001094
6705010.						
709.800	-2.13E-10	.0100631	-.0017329	4.5536E-12	1.7361	8.4555E-05
6705010.						
726.700	-1.22E-10	-.0071490	-.0006103	4.8006E-12	1.7361	4.8303E-05
6705010.						
743.600	-5.09E-11	-.0105653	-3.1640E-05	3.2988E-12	1.7361	2.0178E-05
6705010.						
760.500	-1.02E-11	-.0082185	.0001732	1.7064E-12	1.7361	4.0652E-06
6705010.						
777.400	6.82E-12	-.0047107	.0001847	6.1024E-13	1.7361	-2.7043E-06
6705010.						
794.300	1.04E-11	-.0019752	.0001271	4.3421E-14	1.7361	-4.1182E-06
6705010.						
811.200	8.28E-12	-.0004159	6.4495E-05	-1.5929E-13	1.7361	-3.2865E-06
6705010.						
828.100	5.00E-12	.0002047	2.3019E-05	-1.7719E-13	1.7361	-1.6218E-06
5486330.						
845.000	2.29E-12	.0003622	3.0199E-06	-1.2913E-13	1.7361	-7.4492E-07
5486330.						
861.900	6.31E-13	.0003068	-5.0061E-06	-7.2418E-14	1.7361	-2.0490E-07
5486330.						
878.800	-1.53E-13	.0001930	-6.3176E-06	-3.0048E-14	1.7361	4.9699E-08
5486330.						
895.700	-3.84E-13	9.3282E-05	-4.8430E-06	-5.7816E-15	1.7361	1.2481E-07
5486330.						
912.600	-3.49E-13	2.9258E-05	-2.8324E-06	4.6072E-15	1.7361	1.1314E-07
5486330.						
929.500	-2.29E-13	-2.4516E-06	-1.2489E-06	6.8799E-15	1.7361	7.4253E-08
5486330.						
946.400	-1.16E-13	-1.2954E-05	-3.0332E-07	5.5738E-15	1.7361	3.7648E-08
5486330.						
963.300	-4.03E-14	-1.2704E-05	1.2546E-07	3.3985E-15	1.7361	1.3094E-08
5486330.						
980.200	-1.10E-15	-8.7138E-06	2.3912E-07	1.5828E-15	1.7361	3.5745E-10
5486330.						

24 inch square precast concrete pile - stratum 1 through 4.lpo

997.100	1.32E-14	-4.6216E-06	2.0604E-07	4.5221E-16	1.7361	-4.2731E-09
5486330.						
1014.	1.42E-14	-1.7498E-06	1.3102E-07	-8.7948E-17	1.7361	-4.6045E-09
5486330.						
1031.	1.02E-14	-1.9313E-07	6.4157E-08	-2.5267E-16	1.7361	-3.3081E-09
5486330.						
1048.	5.64E-15	4.1872E-07	2.0723E-08	-2.3354E-16	1.7361	-1.8321E-09
5486330.						
1065.	2.30E-15	5.0731E-07	-1.0581E-09	-1.5503E-16	1.7361	-7.4554E-10
5486330.						
1082.	4.03E-16	3.8297E-07	-8.4644E-09	-7.9557E-17	1.7361	-1.3094E-10
5486330.						
1099.	-3.92E-16	2.2122E-07	-8.4943E-09	-2.8335E-17	1.7361	1.2740E-10
5486330.						
1115.	-5.54E-16	9.5860E-08	-5.8970E-09	-1.4529E-18	1.7361	1.7996E-10
5486330.						
1132.	-4.42E-16	2.1900E-08	-3.1650E-09	8.5306E-18	1.7361	1.4335E-10
5486330.						
1149.	-2.66E-16	-1.1118E-08	-1.2240E-09	9.4447E-18	1.7361	8.6359E-11
5486330.						
1166.	-1.22E-16	-1.9472E-08	-1.5869E-10	6.8513E-18	1.7361	3.9714E-11
5486330.						
1183.	-3.44E-17	-1.6482E-08	2.7138E-10	3.8031E-18	1.7361	1.1182E-11
5486330.						
1200.	6.21E-18	-1.0299E-08	3.4883E-10	1.5326E-18	1.7361	-2.0167E-12
5486330.						
1217.	1.74E-17	-4.6921E-09	2.6753E-10	2.6167E-19	1.7361	-7.6045E-12
7404154.						
1234.	1.51E-17	-1.2568E-09	1.4753E-10	-2.4268E-19	1.7361	-6.5966E-12
7404154.						
1251.	9.15E-18	2.9438E-10	5.7896E-11	-3.2427E-19	1.7361	-4.0109E-12
7404154.						
1268.	4.10E-18	7.0006E-10	8.8392E-12	-2.3996E-19	1.7361	-1.7947E-12
7404154.						
1284.	1.04E-18	5.9315E-10	-1.0191E-11	-1.3033E-19	1.7361	-4.5739E-13
7404154.						
1301.	-3.09E-19	3.5561E-10	-1.2913E-11	-4.9892E-20	1.7361	1.3524E-13
7404154.						
1318.	-6.42E-19	1.5670E-10	-9.3921E-12	-6.4582E-21	1.7361	2.8142E-13
7404154.						
1335.	-5.27E-19	3.8160E-11	-5.0632E-12	1.0062E-20	1.7361	2.3088E-13
7404154.						
1352.	-3.02E-19	-1.4438E-11	-1.9933E-12	1.2073E-20	1.7361	1.3242E-13
7404154.						
1369.	-1.19E-19	-2.9215E-11	-2.2566E-13	8.3722E-21	1.7361	7.6770E-14
1.0911E+07						
1386.	-1.93E-20	-2.2066E-11	5.2820E-13	4.0247E-21	1.7361	1.2445E-14
1.0911E+07						
1403.	1.71E-20	-1.1362E-11	5.3993E-13	1.1907E-21	1.7361	-1.1057E-14
1.0911E+07						
1420.	2.10E-20	-3.8161E-12	3.3209E-13	-9.6046E-23	1.7361	-1.3539E-14
1.0911E+07						
1436.	1.39E-20	-1.3733E-13	1.4196E-13	-4.3122E-22	1.7361	-8.9612E-15
1.0911E+07						
1453.	6.40E-21	9.8206E-13	3.1344E-14	-3.5960E-22	1.7361	-4.1292E-15
1.0911E+07						
1470.	1.73E-21	9.2210E-13	-1.2961E-14	-1.9817E-22	1.7361	-1.1140E-15
1.0911E+07						
1487.	-3.02E-22	5.4398E-13	-2.0724E-14	-7.3876E-23	1.7361	1.9527E-16
1.0911E+07						
1504.	-7.72E-22	2.2162E-13	-1.4865E-14	-8.9687E-24	1.7361	4.9813E-16
1.0911E+07						
1521.	-6.06E-22	4.1540E-14	-7.3521E-15	1.3342E-23	1.7361	3.9098E-16

24 inch square precast concrete pile - stratum 1 through 4.7po

1.0911E+07	1538.	-3.21E-22	-2.6877E-14	-2.2993E-15	1.4585E-23	1.7361	2.0698E-16
1.0911E+07	1555.	-1.13E-22	-3.6177E-14	6.4021E-17	9.2395E-24	1.7361	7.2702E-17
1.0911E+07	1572.	-8.29E-24	-2.4713E-14	7.2360E-16	4.0773E-24	1.7361	5.3543E-18
1.0911E+07	1589.	2.52E-23	-1.1720E-14	6.3133E-16	9.8860E-25	1.7361	-1.6273E-17
1.0911E+07	1605.	2.51E-23	-3.3740E-15	3.5677E-16	-2.9102E-25	1.7361	-1.6219E-17
1.0911E+07	1622.	1.54E-23	3.3937E-16	1.3588E-16	-5.4829E-25	1.7361	-9.9227E-18
1.0911E+07	1639.	6.59E-24	1.2187E-15	1.6083E-17	-4.1620E-25	1.7361	-4.2542E-18
1.0911E+07	1656.	1.30E-24	8.8299E-16	-2.6965E-17	-2.3802E-25	1.7361	-8.4034E-19
1.0911E+07	1673.	-1.46E-24	3.0727E-16	-2.6124E-17	-1.3711E-25	1.7361	9.3991E-19
1.0911E+07	1690.	-3.33E-24	0.0000	0.0000	-1.1106E-25	1.7361	2.1517E-18
5455523.							

Output Verification:

Computed forces and moments are within specified convergence limits.

Output Summary for Load Case No. 1:

Pile-head deflection	=	.00656522 in
Computed slope at pile head	=	-.00007164
Maximum bending moment	=	58021.49000 lbs-in
Maximum shear force	=	1000.00000 lbs
Depth of maximum bending moment	=	84.50000000 in
Depth of maximum shear force	=	0.00000 in
Number of iterations	=	9
Number of zero deflection points	=	15

 Summary of Pile Response(s)

Definition of Symbols for Pile-Head Loading Conditions:

Type 1 = Shear and Moment,	y = pile-head displacement in
Type 2 = Shear and Slope,	M = Pile-head Moment lbs-in
Type 3 = Shear and Rot. Stiffness,	V = Pile-head Shear Force lbs
Type 4 = Deflection and Moment,	S = Pile-head Slope, radians
Type 5 = Deflection and Slope,	R = Rot. Stiffness of Pile-head in-lbs/rad

Load Type	Pile-Head Condition 1	Pile-Head Condition 2	Axial Load lbs	Pile-Head Deflection in	Maximum Moment in-lbs	Maximum Shear lbs
1	V= 1000.000	M= 1000.000	1000.0000	.0065652	58021.4900	1000.0000

The analysis ended normally.

24 inch square precast concrete pile - stratum 5 through 7.1po

LPILE Plus for Windows, Version 5.0 (5.0.30)

Analysis of Individual Piles and Drilled Shafts
Subjected to Lateral Loading Using the p-y Method

(c) 1985-2007 by Ensoft, Inc.
All Rights Reserved

This program is licensed to:

DJI
Eustis

Path to file locations: U:\sys\WPDATA\Projects\20749\Piles\LPile\
Name of input data file: 24 inch square precast concrete pile - stratum 5
through 7.1pd
Name of output file: 24 inch square precast concrete pile - stratum 5
through 7.1po
Name of plot output file: 24 inch square precast concrete pile - stratum 5
through 7.1pp
Name of runtime file: 24 inch square precast concrete pile - stratum 5
through 7.1pr

Time and Date of Analysis

Date: November 10, 2009 Time: 8:19:47

Problem Title

EE20749 - St. Mary Floodgate Structure at Franklin Drainage Canal

Program Options

Units Used in Computations - US Customary Units: Inches, Pounds

Basic Program Options:

Analysis Type 1:

- Computation of Lateral Pile Response Using User-specified Constant EI

Computation Options:

- Only internally-generated p-y curves used in analysis
- Analysis does not use p-y multipliers (individual pile or shaft action only)
- Analysis assumes no shear resistance at pile tip
- Analysis for fixed-length pile or shaft only
- No computation of foundation stiffness matrix elements
- Output pile response for full length of pile
- Analysis assumes no soil movements acting on pile
- Additional p-y curves computed at specified depths

24 inch square precast concrete pile - stratum 5 through 7.lpo

Solution Control Parameters:

- Number of pile increments = 100
- Maximum number of iterations allowed = 100
- Deflection tolerance for convergence = 1.0000E-05 in
- Maximum allowable deflection = 1.0000E+02 in

Printing Options:

- Values of pile-head deflection, bending moment, shear force, and soil reaction are printed for full length of pile.
- Printing Increment (spacing of output points) = 1

Pile Structural Properties and Geometry

- Pile Length = 1690.00 in
- Depth of ground surface below top of pile = .00 in
- Slope angle of ground surface = .00 deg.

Structural properties of pile defined using 2 points

Point	Depth X in	Pile Diameter in	Moment of Inertia in**4	Pile Area Sq.in	Modulus of Elasticity lbs/Sq.in
1	0.0000	24.00000000	27648.0000	576.0000	3604997.
2	1690.0000	24.00000000	27648.0000	576.0000	3604997.

Soil and Rock Layering Information

The soil profile is modelled using 10 layers

Layer 1 is silt with cohesion and friction

- Distance from top of pile to top of layer = .000 in
- Distance from top of pile to bottom of layer = 36.000 in
- p-y subgrade modulus k for top of soil layer = 55.600 lbs/in**3
- p-y subgrade modulus k for bottom of layer = 55.600 lbs/in**3

Layer 2 is soft clay, p-y criteria by Matlock, 1970

- Distance from top of pile to top of layer = 36.000 in
- Distance from top of pile to bottom of layer = 180.000 in

Layer 3 is silt with cohesion and friction

- Distance from top of pile to top of layer = 180.000 in
- Distance from top of pile to bottom of layer = 204.000 in
- p-y subgrade modulus k for top of soil layer = 55.600 lbs/in**3
- p-y subgrade modulus k for bottom of layer = 55.600 lbs/in**3

Layer 4 is soft clay, p-y criteria by Matlock, 1970

- Distance from top of pile to top of layer = 204.000 in
- Distance from top of pile to bottom of layer = 276.000 in

Layer 5 is soft clay, p-y criteria by Matlock, 1970

- Distance from top of pile to top of layer = 276.000 in
- Distance from top of pile to bottom of layer = 516.000 in

Layer 6 is stiff clay without free water

- Distance from top of pile to top of layer = 516.000 in

24 inch square precast concrete pile - stratum 5 through 7.1po
 Distance from top of pile to bottom of layer = 612.000 in

Layer 7 is stiff clay without free water
 Distance from top of pile to top of layer = 612.000 in
 Distance from top of pile to bottom of layer = 828.000 in

Layer 8 is stiff clay without free water
 Distance from top of pile to top of layer = 828.000 in
 Distance from top of pile to bottom of layer = 1212.000 in

Layer 9 is stiff clay without free water
 Distance from top of pile to top of layer = 1212.000 in
 Distance from top of pile to bottom of layer = 1356.000 in

Layer 10 is stiff clay without free water
 Distance from top of pile to top of layer = 1356.000 in
 Distance from top of pile to bottom of layer = 1692.000 in

(Depth of lowest layer extends 2.00 in below pile tip)

 Effective Unit Weight of Soil vs. Depth

Distribution of effective unit weight of soil with depth
 is defined using 20 points

Point No.	Depth X in	Eff. Unit Weight lbs/in**3
1	.00	.03160
2	36.00	.03160
3	36.00	.03330
4	180.00	.03330
5	180.00	.03160
6	204.00	.03160
7	204.00	.03480
8	276.00	.03480
9	276.00	.03250
10	516.00	.03250
11	516.00	.03620
12	612.00	.03620
13	612.00	.03550
14	828.00	.03550
15	828.00	.03110
16	1212.00	.03110
17	1212.00	.03040
18	1356.00	.03040
19	1356.00	.03450
20	1692.00	.03450

 Shear Strength of Soils

Distribution of shear strength parameters with depth
 defined using 20 points

Point	Depth X	Cohesion c	Angle of Friction	E50 or	RQD
-------	---------	------------	-------------------	--------	-----

No.	24 inch square precast concrete pile - stratum 5 through 7.1po in	lbs/in**2	Deg.	k _{rm}	%
1	.000	1.38890	15.00	.02000	.0
2	36.000	1.38890	15.00	.02000	.0
3	36.000	2.20140	.00	.02000	.0
4	180.000	2.20140	.00	.02000	.0
5	180.000	1.38890	15.00	.02000	.0
6	204.000	1.38890	15.00	.02000	.0
7	204.000	3.12500	.00	.02000	.0
8	276.000	3.12500	.00	.02000	.0
9	276.000	4.16670	.00	.01000	.0
10	516.000	7.63890	.00	.00700	.0
11	516.000	7.63890	.00	.00700	.0
12	612.000	7.63890	.00	.00700	.0
13	612.000	9.59030	.00	.00700	.0
14	828.000	9.59030	.00	.00700	.0
15	828.000	7.84720	.00	.00700	.0
16	1212.000	7.84720	.00	.00700	.0
17	1212.000	10.59030	.00	.00700	.0
18	1356.000	10.59030	.00	.00700	.0
19	1356.000	14.34720	.00	.00500	.0
20	1692.000	14.34720	.00	.00500	.0

Notes:

- (1) Cohesion = uniaxial compressive strength for rock materials.
- (2) Values of E50 are reported for clay strata.
- (3) Default values will be generated for E50 when input values are 0.
- (4) RQD and k_{rm} are reported only for weak rock strata.

Loading Type

Cyclic loading criteria was used for computation of p-y curves

Number of cycles of loading = 1000.

Pile-head Loading and Pile-head Fixity Conditions

Number of loads specified = 1

Load Case Number 1

Pile-head boundary conditions are Shear and Moment (BC Type 1)

Shear force at pile head = 1000.000 lbs
 Bending moment at pile head = 1000.000 in-lbs
 Axial load at pile head = 1000.000 lbs

Non-zero moment at pile head for this load case indicates the pile-head may rotate under the applied pile-head loading, but is not a free-head (zero moment) condition.

24 inch square precast concrete pile - stratum 5 through 7.1po

 Output of p-y Curves at Specified Depths

p-y curves are generated and printed for verification at 9 depths.

Depth No.	Depth Below Pile Head in	Depth Below Ground Surface in
1	288.000	288.000
2	396.000	396.000
3	504.000	504.000
4	528.000	528.000
5	564.000	564.000
6	600.000	600.000
7	624.000	624.000
8	720.000	720.000
9	816.000	816.000

Depth of ground surface below top of pile = .00 in

p-y Curve Computed Using the Soft Clay Criteria for Cyclic Loading Conditions

Soil Layer Number = 5
 Depth below pile head = 288.000 in
 Depth below ground surface = 288.000 in
 Equivalent Depth = 312.568 in
 Pile Diameter = 24.000 in
 Cohesion, c = 4.340 lbs/in**2
 Avg Eff Unit Weight = .03329 lbs/in**3
 E50 parameter = .00985
 Default J parameter = .500
 Y50 = .59100 in
 p-multiplier = 1.00000
 y-multiplier = 1.00000
 Number of cycles of loading = 1000.
 Xr = 210.506 in

y, in	p, lbs/in
0.0000	0.0000
.0047280	93.7507
.1477500	295.2962
.2955000	372.0499
.4432500	425.8908
.5910000	468.7535
.7387500	504.9494
.8865000	536.5888
1.0343	564.8813
1.1820	590.5924
1.3298	614.2408
1.4775	636.1964
1.6253	656.7329
1.7730	675.0050
4.7280	675.0050
8.8650	675.0050
11.8200	675.0050

p-y Curve Computed Using the Soft Clay Criteria for Cyclic Loading Conditions

24 inch square precast concrete pile - stratum 5 through 7.1po

Soil Layer Number = 5
 Depth below pile head = 396.000 in
 Depth below ground surface = 396.000 in
 Equivalent Depth = 420.568 in
 Pile Diameter = 24.000 in
 Cohesion, c = 5.903 lbs/in**2
 Avg Eff Unit Weight = .03307 lbs/in**3
 E50 parameter = .00850
 Default J parameter = .500
 Y50 = .51000 in
 p-multiplier = 1.00000
 y-multiplier = 1.00000
 Number of cycles of loading = 1000.
 Xr = 226.961 in

y, in	p, lbs/in
0.0000	0.0000
.0040800	127.5005
.1275000	401.6013
.2550000	505.9860
.3825000	579.2094
.5100000	637.5024
.6375000	686.7286
.7650000	729.7581
.8925000	768.2357
1.0200	803.2027
1.1475	835.3645
1.2750	865.2239
1.4025	893.1534
1.5300	919.4376
4.0800	918.0035
7.6500	918.0035
10.2000	918.0035

p-y Curve Computed Using the Soft Clay Criteria for Cyclic Loading Conditions

Soil Layer Number = 5
 Depth below pile head = 504.000 in
 Depth below ground surface = 504.000 in
 Equivalent Depth = 528.568 in
 Pile Diameter = 24.000 in
 Cohesion, c = 7.465 lbs/in**2
 Avg Eff Unit Weight = .03295 lbs/in**3
 E50 parameter = .00715
 Default J parameter = .500
 Y50 = .42900 in
 p-multiplier = 1.00000
 y-multiplier = 1.00000
 Number of cycles of loading = 1000.
 Xr = 237.651 in

y, in	p, lbs/in
0.0000	0.0000
.0034320	161.2503
.1072500	507.9065
.2145000	639.9221
.3217500	732.5279
.4290000	806.2513
.5362500	868.5079

24 inch square precast concrete pile - stratum 5 through 7.1po

.6435000	922.9274
.7507500	971.5902
.8580000	1015.8130
.9652500	1056.4881
1.0725	1094.2514
1.1797	1129.5740
1.2870	1162.8156
3.4320	1161.0019
6.4350	1161.0019
8.5800	1161.0019

p-y Curve Computed Using Cyclic Criteria for Stiff Clay without Free Water

Soil Layer Number	=	6
Depth below pile head	=	528.000 in
Depth below ground surface	=	528.000 in
Equivalent Depth	=	300.910 in
Diameter	=	24.000 in
Undrained cohesion, c	=	7.63890 lbs/in**2
Average Eff. Unit Weight	=	.03301 lbs/in**3
Epsilon-50	=	.00700
Pct	=	1937.732 lbs/in
Pcd	=	1650.002 lbs/in
Pu	=	1650.002 lbs/in
y50	=	.420 in
p-multiplier	=	1.00000
y-multiplier	=	1.00000
Number of cycles of loading	=	1000.

y, in	p, lbs/in
0.0000	0.0000
6.7200E-05	71.7290
.0003360	107.2599
.0006720	127.5543
.0033600	190.7382
.0067200	226.8272
.0336000	339.1857
.0672000	403.3621
.1680000	507.2010
.3360000	603.1670
.5040000	667.5140
.6720000	717.2905
1.6800	901.9450
3.3600	1072.5994
6.7200	1275.5429
15.1200	1562.2146
23.5200	1650.0024

p-y Curve Computed Using Cyclic Criteria for Stiff Clay without Free Water

Soil Layer Number	=	6
Depth below pile head	=	564.000 in
Depth below ground surface	=	564.000 in
Equivalent Depth	=	336.910 in
Diameter	=	24.000 in
Undrained cohesion, c	=	7.63890 lbs/in**2
Average Eff. Unit Weight	=	.03322 lbs/in**3

Page 7

24 inch square precast concrete pile - stratum 5 through 7.1po

```

Epsilon-50      =      .00700
Pct             =      2105.400 lbs/in
Pcd            =      1650.002 lbs/in
Pu             =      1650.002 lbs/in
y50           =      .420 in
p-multiplier   =      1.00000
y-multiplier   =      1.00000
Number of cycles of loading = 1000.

```

y, in	p, lbs/in
0.0000	0.0000
6.7200E-05	71.7290
.0003360	107.2599
.0006720	127.5543
.0033600	190.7382
.0067200	226.8272
.0336000	339.1857
.0672000	403.3621
.1680000	507.2010
.3360000	603.1670
.5040000	667.5140
.6720000	717.2905
1.6800	901.9450
3.3600	1072.5994
6.7200	1275.5429
15.1200	1562.2146
23.5200	1650.0024

p-y Curve Computed Using Cyclic Criteria for Stiff Clay without Free Water

```

Soil Layer Number      =      6
Depth below pile head  =      600.000 in
Depth below ground surface = 600.000 in
Equivalent Depth       =      372.910 in
Diameter               =      24.000 in
Undrained cohesion, c =      7.63890 lbs/in**2
Average Eff. Unit Weight = .03340 lbs/in**3
Epsilon-50            =      .00700
Pct                   =      2273.202 lbs/in
Pcd                   =      1650.002 lbs/in
Pu                    =      1650.002 lbs/in
y50                   =      .420 in
p-multiplier          =      1.00000
y-multiplier          =      1.00000
Number of cycles of loading = 1000.

```

y, in	p, lbs/in
0.0000	0.0000
6.7200E-05	71.7290
.0003360	107.2599
.0006720	127.5543
.0033600	190.7382
.0067200	226.8272
.0336000	339.1857
.0672000	403.3621
.1680000	507.2010
.3360000	603.1670
.5040000	667.5140
.6720000	717.2905
1.6800	901.9450

24 inch square precast concrete pile - stratum 5 through 7.1po
 3.3600 1072.5994
 6.7200 1275.5429
 15.1200 1562.2146
 23.5200 1650.0024

p-y Curve Computed Using Cyclic Criteria for Stiff Clay without Free Water

Soil Layer Number = 7
 Depth below pile head = 624.000 in
 Depth below ground surface = 624.000 in
 Equivalent Depth = 331.177 in
 Diameter = 24.000 in
 Undrained cohesion, c = 9.59030 lbs/in**2
 Average Eff. Unit Weight = .03349 lbs/in**3
 Epsilon-50 = .00700
 Pct = 2544.737 lbs/in
 Pcd = 2071.505 lbs/in
 Pu = 2071.505 lbs/in
 y50 = .420 in
 p-multiplier = 1.00000
 y-multiplier = 1.00000
 Number of cycles of loading = 1000.

y, in	p, lbs/in
0.0000	0.0000
6.7200E-05	90.0526
.0003360	134.6601
.0006720	160.1387
.0033600	239.4633
.0067200	284.7714
.0336000	425.8326
.0672000	506.4032
.1680000	636.7683
.3360000	757.2494
.5040000	838.0342
.6720000	900.5264
1.6800	1132.3520
3.3600	1346.6010
6.7200	1601.3875
15.1200	1961.2911
23.5200	2071.5048

p-y Curve Computed Using Cyclic Criteria for Stiff Clay without Free Water

Soil Layer Number = 7
 Depth below pile head = 720.000 in
 Depth below ground surface = 720.000 in
 Equivalent Depth = 427.177 in
 Diameter = 24.000 in
 Undrained cohesion, c = 9.59030 lbs/in**2
 Average Eff. Unit Weight = .03376 lbs/in**3
 Epsilon-50 = .00700
 Pct = 3084.980 lbs/in
 Pcd = 2071.505 lbs/in
 Pu = 2071.505 lbs/in
 y50 = .420 in
 p-multiplier = 1.00000

24 inch square precast concrete pile - stratum 5 through 7.1po
 y-multiplier = 1.00000
 Number of cycles of loading = 1000.

y, in	p, lbs/in
0.0000	0.0000
6.7200E-05	90.0526
.0003360	134.6601
.0006720	160.1387
.0033600	239.4633
.0067200	284.7714
.0336000	425.8326
.0672000	506.4032
.1680000	636.7683
.3360000	757.2494
.5040000	838.0342
.6720000	900.5264
1.6800	1132.3520
3.3600	1346.6010
6.7200	1601.3875
15.1200	1961.2911
23.5200	2071.5048

p-y Curve Computed Using Cyclic Criteria for Stiff Clay without Free Water

Soil Layer Number = 7
 Depth below pile head = 816.000 in
 Depth below ground surface = 816.000 in
 Equivalent Depth = 523.177 in
 Diameter = 24.000 in
 Undrained cohesion, c = 9.59030 lbs/in**2
 Average Eff. Unit Weight = .03396 lbs/in**3
 Epsilon-50 = .00700
 Pct = 3625.666 lbs/in
 Pcd = 2071.505 lbs/in
 Pu = 2071.505 lbs/in
 y50 = .420 in
 p-multiplier = 1.00000
 y-multiplier = 1.00000
 Number of cycles of loading = 1000.

y, in	p, lbs/in
0.0000	0.0000
6.7200E-05	90.0526
.0003360	134.6601
.0006720	160.1387
.0033600	239.4633
.0067200	284.7714
.0336000	425.8326
.0672000	506.4032
.1680000	636.7683
.3360000	757.2494
.5040000	838.0342
.6720000	900.5264
1.6800	1132.3520
3.3600	1346.6010
6.7200	1601.3875
15.1200	1961.2911
23.5200	2071.5048

24 inch square precast concrete pile - stratum 5 through 7.1po

 Computed Values of Load Distribution and Deflection
 for Lateral Loading for Load Case Number 1

Pile-head boundary conditions are Shear and Moment (BC Type 1)
 Specified shear force at pile head = 1000.000 lbs
 Specified moment at pile head = 1000.000 in-lbs
 Specified axial load at pile head = 1000.000 lbs

Non-zero moment for this load case indicates the pile-head may rotate under the applied pile-head loading, but is not a free-head (zero moment) condition.

Depth Es*h X F/L in lbs/in	Deflect. y in	Moment M lbs-in	Shear V lbs	Slope S Rad.	Total Stress lbs/in**2	Soil Res. p lbs/in
0.000	.006565	1000.0000	1000.0000	-7.1641E-05	2.1701	0.0000
0.0000						
16.900	.005356	17901.2093	957.4742	-7.0038E-05	9.5057	-5.0326
15879.9160						
33.800	.004198	33364.9938	848.2856	-6.5692E-05	16.2174	-7.8891
31759.8320						
50.700	.003136	46575.4818	634.0616	-5.8915E-05	21.9512	-17.4629
94121.8447						
67.600	.002207	54798.2666	338.5890	-5.0320E-05	25.5201	-17.5043
134062.						
84.500	.001435	58021.4900	48.0918	-4.0756E-05	26.9190	-16.8741
198767.						
101.400	.000829	56425.1477	-225.3167	-3.1053E-05	26.2262	-15.4820
315591.						
118.300	.000385	50406.8343	-451.4965	-2.1996E-05	23.6141	-11.2849
495215.						
135.200	8.56E-05	41165.3102	-569.8322	-1.4233E-05	19.6030	-2.7194
536862.						
152.100	-9.59E-05	31146.9882	-565.0581	-8.1020E-06	15.2548	3.2844
578509.						
169.000	-.000188	22066.6204	-479.2543	-3.5906E-06	11.3136	6.8699
616768.						
185.900	-.000217	14948.3136	-404.2413	-4.5248E-07	8.2241	2.0073
156111.						
202.800	-.000204	8403.2806	-369.7760	1.5272E-06	5.3834	2.0714
171991.						
219.700	-.000166	2449.8332	-279.7408	2.4474E-06	2.7994	8.5837
875533.						
236.600	-.000121	-1052.0398	-154.3195	2.5659E-06	2.1927	6.2591
875533.						
253.500	-7.90E-05	-2766.2529	-66.8640	2.2421E-06	2.9367	4.0907
875533.						
270.400	-4.50E-05	-3312.1191	-12.5845	1.7268E-06	3.1737	2.3329
875533.						
287.300	-2.06E-05	-3191.6665	22.9425	1.1754E-06	3.1214	1.8714
1535789.						
304.200	-5.30E-06	-2536.7016	43.0882	6.8980E-07	2.8371	.5126621
1634263.						
321.100	2.72E-06	-1735.3081	45.0600	3.2762E-07	2.4893	-.2793107

24 inch square precast concrete pile - stratum 5 through 7.1po

1734362.						
338.000	5.77E-06	-1013.6835	37.4005	9.4567E-08	2.1761	-.6271429
1836160.						
354.900	5.92E-06	-471.1742	26.3614	-3.1318E-08	1.9406	-.6792572
1939740.						
371.800	4.71E-06	-122.6663	15.8015	-8.1663E-08	1.7894	-.5704368
2045190.						
388.700	3.16E-06	62.9196	7.5825	-8.6728E-08	1.7634	-.4022229
2152606.						
405.600	1.78E-06	133.6263	2.1679	-7.0065E-08	1.7941	-.2385603
2262088.						
422.500	7.90E-07	136.1975	-.7851124	-4.7190E-08	1.7952	-.1109107
2373749.						
439.400	1.87E-07	107.0911	-1.9552	-2.6564E-08	1.7826	-.0275659
2487708.						
456.300	-1.08E-07	70.1113	-2.0473	-1.1541E-08	1.7665	.0166766
2604096.						
473.200	-2.03E-07	37.8943	-1.6302	-2.3843E-09	1.7526	.0326791
2723054.						
490.100	-1.89E-07	15.0107	-1.0855	2.1010E-09	1.7426	.0317830
2844737.						
507.000	-1.32E-07	1.2046	-.6212443	3.4757E-09	1.7366	.0231576
2969314.						
523.900	-7.13E-08	-5.9874	-.2350657	3.0702E-09	1.7387	.0225440
5340698.						
540.800	-2.80E-08	-6.7407	.0302800	1.9911E-09	1.7390	.0088579
5340698.						
557.700	-4.04E-09	-4.9640	.1159103	9.9882E-10	1.7383	.0012759
5340698.						
574.600	5.73E-09	-2.8230	.1113894	3.3865E-10	1.7373	-.0018109
5340698.						
591.500	7.41E-09	-1.1991	.0763029	-2.3366E-12	1.7366	-.0023413
5340698.						
608.400	5.65E-09	-.2439170	.0414273	-1.2467E-10	1.7362	-.0017859
5340698.						
625.300	3.19E-09	.2011641	.0156249	-1.2830E-10	1.7362	-.0012676
6705010.						
642.200	1.31E-09	.2842073	.0005052	-8.7148E-11	1.7362	-.0005217
6705010.						
659.100	2.49E-10	.2182441	-.0047392	-4.4551E-11	1.7362	-9.8939E-05
6705010.						
676.000	-1.91E-10	.1240224	-.0049355	-1.5534E-11	1.7362	7.5713E-05
6705010.						
692.900	-2.76E-10	.0514248	-.0033716	-6.5930E-13	1.7361	.0001094
6705010.						
709.800	-2.13E-10	.0100631	-.0017329	4.5536E-12	1.7361	8.4555E-05
6705010.						
726.700	-1.22E-10	-.0071490	-.0006103	4.8006E-12	1.7361	4.8303E-05
6705010.						
743.600	-5.09E-11	-.0105653	-3.1640E-05	3.2988E-12	1.7361	2.0178E-05
6705010.						
760.500	-1.02E-11	-.0082185	.0001732	1.7064E-12	1.7361	4.0652E-06
6705010.						
777.400	6.82E-12	-.0047107	.0001847	6.1024E-13	1.7361	-2.7043E-06
6705010.						
794.300	1.04E-11	-.0019752	.0001271	4.3421E-14	1.7361	-4.1182E-06
6705010.						
811.200	8.28E-12	-.0004159	6.4495E-05	-1.5929E-13	1.7361	-3.2865E-06
6705010.						
828.100	5.00E-12	.0002047	2.3019E-05	-1.7719E-13	1.7361	-1.6218E-06
5486330.						
845.000	2.29E-12	.0003622	3.0199E-06	-1.2913E-13	1.7361	-7.4492E-07
5486330.						

24 inch square precast concrete pile - stratum 5 through 7.lpo

861.900	6.31E-13	.0003068	-5.0061E-06	-7.2418E-14	1.7361	-2.0490E-07
5486330.						
878.800	-1.53E-13	.0001930	-6.3176E-06	-3.0048E-14	1.7361	4.9699E-08
5486330.						
895.700	-3.84E-13	9.3282E-05	-4.8430E-06	-5.7816E-15	1.7361	1.2481E-07
5486330.						
912.600	-3.49E-13	2.9258E-05	-2.8324E-06	4.6072E-15	1.7361	1.1314E-07
5486330.						
929.500	-2.29E-13	-2.4516E-06	-1.2489E-06	6.8799E-15	1.7361	7.4253E-08
5486330.						
946.400	-1.16E-13	-1.2954E-05	-3.0332E-07	5.5738E-15	1.7361	3.7648E-08
5486330.						
963.300	-4.03E-14	-1.2704E-05	1.2546E-07	3.3985E-15	1.7361	1.3094E-08
5486330.						
980.200	-1.10E-15	-8.7138E-06	2.3912E-07	1.5828E-15	1.7361	3.5745E-10
5486330.						
997.100	1.32E-14	-4.6216E-06	2.0604E-07	4.5221E-16	1.7361	-4.2731E-09
5486330.						
1014.	1.42E-14	-1.7498E-06	1.3102E-07	-8.7948E-17	1.7361	-4.6045E-09
5486330.						
1031.	1.02E-14	-1.9313E-07	6.4157E-08	-2.5267E-16	1.7361	-3.3081E-09
5486330.						
1048.	5.64E-15	4.1872E-07	2.0723E-08	-2.3354E-16	1.7361	-1.8321E-09
5486330.						
1065.	2.30E-15	5.0731E-07	-1.0581E-09	-1.5503E-16	1.7361	-7.4554E-10
5486330.						
1082.	4.03E-16	3.8297E-07	-8.4644E-09	-7.9557E-17	1.7361	-1.3094E-10
5486330.						
1099.	-3.92E-16	2.2122E-07	-8.4943E-09	-2.8335E-17	1.7361	1.2740E-10
5486330.						
1115.	-5.54E-16	9.5860E-08	-5.8970E-09	-1.4529E-18	1.7361	1.7996E-10
5486330.						
1132.	-4.42E-16	2.1900E-08	-3.1650E-09	8.5306E-18	1.7361	1.4335E-10
5486330.						
1149.	-2.66E-16	-1.1118E-08	-1.2240E-09	9.4447E-18	1.7361	8.6359E-11
5486330.						
1166.	-1.22E-16	-1.9472E-08	-1.5869E-10	6.8513E-18	1.7361	3.9714E-11
5486330.						
1183.	-3.44E-17	-1.6482E-08	2.7138E-10	3.8031E-18	1.7361	1.1182E-11
5486330.						
1200.	6.21E-18	-1.0299E-08	3.4883E-10	1.5326E-18	1.7361	-2.0167E-12
5486330.						
1217.	1.74E-17	-4.6921E-09	2.6753E-10	2.6167E-19	1.7361	-7.6045E-12
7404154.						
1234.	1.51E-17	-1.2568E-09	1.4753E-10	-2.4268E-19	1.7361	-6.5966E-12
7404154.						
1251.	9.15E-18	2.9438E-10	5.7896E-11	-3.2427E-19	1.7361	-4.0109E-12
7404154.						
1268.	4.10E-18	7.0006E-10	8.8392E-12	-2.3996E-19	1.7361	-1.7947E-12
7404154.						
1284.	1.04E-18	5.9315E-10	-1.0191E-11	-1.3033E-19	1.7361	-4.5739E-13
7404154.						
1301.	-3.09E-19	3.5561E-10	-1.2913E-11	-4.9892E-20	1.7361	1.3524E-13
7404154.						
1318.	-6.42E-19	1.5670E-10	-9.3921E-12	-6.4582E-21	1.7361	2.8142E-13
7404154.						
1335.	-5.27E-19	3.8160E-11	-5.0632E-12	1.0062E-20	1.7361	2.3088E-13
7404154.						
1352.	-3.02E-19	-1.4438E-11	-1.9933E-12	1.2073E-20	1.7361	1.3242E-13
7404154.						
1369.	-1.19E-19	-2.9215E-11	-2.2566E-13	8.3722E-21	1.7361	7.6770E-14
1.0911E+07						
1386.	-1.93E-20	-2.2066E-11	5.2820E-13	4.0247E-21	1.7361	1.2445E-14

24 inch square precast concrete pile - stratum 5 through 7.lpo

1.0911E+07	1403.	1.71E-20	-1.1362E-11	5.3993E-13	1.1907E-21	1.7361	-1.1057E-14
1.0911E+07	1420.	2.10E-20	-3.8161E-12	3.3209E-13	-9.6046E-23	1.7361	-1.3539E-14
1.0911E+07	1436.	1.39E-20	-1.3733E-13	1.4196E-13	-4.3122E-22	1.7361	-8.9612E-15
1.0911E+07	1453.	6.40E-21	9.8206E-13	3.1344E-14	-3.5960E-22	1.7361	-4.1292E-15
1.0911E+07	1470.	1.73E-21	9.2210E-13	-1.2961E-14	-1.9817E-22	1.7361	-1.1140E-15
1.0911E+07	1487.	-3.02E-22	5.4398E-13	-2.0724E-14	-7.3876E-23	1.7361	1.9527E-16
1.0911E+07	1504.	-7.72E-22	2.2162E-13	-1.4865E-14	-8.9687E-24	1.7361	4.9813E-16
1.0911E+07	1521.	-6.06E-22	4.1540E-14	-7.3521E-15	1.3342E-23	1.7361	3.9098E-16
1.0911E+07	1538.	-3.21E-22	-2.6877E-14	-2.2993E-15	1.4585E-23	1.7361	2.0698E-16
1.0911E+07	1555.	-1.13E-22	-3.6177E-14	6.4021E-17	9.2395E-24	1.7361	7.2702E-17
1.0911E+07	1572.	-8.29E-24	-2.4713E-14	7.2360E-16	4.0773E-24	1.7361	5.3543E-18
1.0911E+07	1589.	2.52E-23	-1.1720E-14	6.3133E-16	9.8860E-25	1.7361	-1.6273E-17
1.0911E+07	1605.	2.51E-23	-3.3740E-15	3.5677E-16	-2.9102E-25	1.7361	-1.6219E-17
1.0911E+07	1622.	1.54E-23	3.3937E-16	1.3588E-16	-5.4829E-25	1.7361	-9.9227E-18
1.0911E+07	1639.	6.59E-24	1.2187E-15	1.6083E-17	-4.1620E-25	1.7361	-4.2542E-18
1.0911E+07	1656.	1.30E-24	8.8299E-16	-2.6965E-17	-2.3802E-25	1.7361	-8.4034E-19
1.0911E+07	1673.	-1.46E-24	3.0727E-16	-2.6124E-17	-1.3711E-25	1.7361	9.3991E-19
1.0911E+07	1690.	-3.33E-24	0.0000	0.0000	-1.1106E-25	1.7361	2.1517E-18
5455523.							

Output Verification:

Computed forces and moments are within specified convergence limits.

Output Summary for Load Case No. 1:

Pile-head deflection	=	.00656522 in
Computed slope at pile head	=	-.00007164
Maximum bending moment	=	58021.49000 lbs-in
Maximum shear force	=	1000.00000 lbs
Depth of maximum bending moment	=	84.50000000 in
Depth of maximum shear force	=	0.00000 in
Number of iterations	=	9
Number of zero deflection points	=	15

 Summary of Pile Response(s)

Definition of Symbols for Pile-Head Loading Conditions:

24 inch square precast concrete pile - stratum 5 through 7.1po

Type 1 = Shear and Moment, y = pile-head displacement in
 Type 2 = Shear and Slope, M = Pile-head Moment lbs-in
 Type 3 = Shear and Rot. Stiffness, V = Pile-head Shear Force lbs
 Type 4 = Deflection and Moment, S = Pile-head Slope, radians
 Type 5 = Deflection and Slope, R = Rot. Stiffness of Pile-head in-lbs/rad

Load Type	Pile-Head Condition 1	Pile-Head Condition 2	Axial Load lbs	Pile-Head Deflection in	Maximum Moment in-lbs	Maximum Shear lbs
1	V= 1000.000	M= 1000.000	1000.0000	.0065652	58021.4900	1000.0000

The analysis ended normally.

24 inch square precast concrete pile - stratum 8 through 10.lpo

LPILE Plus for Windows, Version 5.0 (5.0.30)

Analysis of Individual Piles and Drilled Shafts
Subjected to Lateral Loading Using the p-y Method

(c) 1985-2007 by Ensoft, Inc.
All Rights Reserved

This program is licensed to:

DJI
Eustis

Path to file locations: U:\sys\WPDATA\Projects\20749\Piles\LPile\
Name of input data file: 24 inch square precast concrete pile - stratum 8
through 10.lpd
Name of output file: 24 inch square precast concrete pile - stratum 8
through 10.lpo
Name of plot output file: 24 inch square precast concrete pile - stratum 8
through 10.lpp
Name of runtime file: 24 inch square precast concrete pile - stratum 8
through 10.lpr

Time and Date of Analysis

Date: November 10, 2009 Time: 8:21:20

Problem Title

EE20749 - St. Mary Floodgate Structure at Franklin Drainage Canal

Program Options

Units Used in Computations - US Customary Units: Inches, Pounds

Basic Program Options:

Analysis Type 1:

- Computation of Lateral Pile Response Using User-specified Constant EI

Computation Options:

- Only internally-generated p-y curves used in analysis
- Analysis does not use p-y multipliers (individual pile or shaft action only)
- Analysis assumes no shear resistance at pile tip
- Analysis for fixed-length pile or shaft only
- No computation of foundation stiffness matrix elements
- Output pile response for full length of pile
- Analysis assumes no soil movements acting on pile
- Additional p-y curves computed at specified depths

24 inch square precast concrete pile - stratum 8 through 10.1po

Solution Control Parameters:

- Number of pile increments = 100
- Maximum number of iterations allowed = 100
- Deflection tolerance for convergence = 1.0000E-05 in
- Maximum allowable deflection = 1.0000E+02 in

Printing Options:

- Values of pile-head deflection, bending moment, shear force, and soil reaction are printed for full length of pile.
- Printing Increment (spacing of output points) = 1

Pile Structural Properties and Geometry

- Pile Length = 1690.00 in
- Depth of ground surface below top of pile = .00 in
- Slope angle of ground surface = .00 deg.

Structural properties of pile defined using 2 points

Point	Depth X in	Pile Diameter in	Moment of Inertia in**4	Pile Area Sq.in	Modulus of Elasticity lbs/Sq.in
1	0.0000	24.00000000	27648.0000	576.0000	3604997.
2	1690.0000	24.00000000	27648.0000	576.0000	3604997.

Soil and Rock Layering Information

The soil profile is modelled using 10 layers

Layer 1 is silt with cohesion and friction

- Distance from top of pile to top of layer = .000 in
- Distance from top of pile to bottom of layer = 36.000 in
- p-y subgrade modulus k for top of soil layer = 55.600 lbs/in**3
- p-y subgrade modulus k for bottom of layer = 55.600 lbs/in**3

Layer 2 is soft clay, p-y criteria by Matlock, 1970

- Distance from top of pile to top of layer = 36.000 in
- Distance from top of pile to bottom of layer = 180.000 in

Layer 3 is silt with cohesion and friction

- Distance from top of pile to top of layer = 180.000 in
- Distance from top of pile to bottom of layer = 204.000 in
- p-y subgrade modulus k for top of soil layer = 55.600 lbs/in**3
- p-y subgrade modulus k for bottom of layer = 55.600 lbs/in**3

Layer 4 is soft clay, p-y criteria by Matlock, 1970

- Distance from top of pile to top of layer = 204.000 in
- Distance from top of pile to bottom of layer = 276.000 in

Layer 5 is soft clay, p-y criteria by Matlock, 1970

- Distance from top of pile to top of layer = 276.000 in
- Distance from top of pile to bottom of layer = 516.000 in

Layer 6 is stiff clay without free water

- Distance from top of pile to top of layer = 516.000 in

24 inch square precast concrete pile - stratum 8 through 10.1po
 Distance from top of pile to bottom of layer = 612.000 in

Layer 7 is stiff clay without free water
 Distance from top of pile to top of layer = 612.000 in
 Distance from top of pile to bottom of layer = 828.000 in

Layer 8 is stiff clay without free water
 Distance from top of pile to top of layer = 828.000 in
 Distance from top of pile to bottom of layer = 1212.000 in

Layer 9 is stiff clay without free water
 Distance from top of pile to top of layer = 1212.000 in
 Distance from top of pile to bottom of layer = 1356.000 in

Layer 10 is stiff clay without free water
 Distance from top of pile to top of layer = 1356.000 in
 Distance from top of pile to bottom of layer = 1692.000 in

(Depth of lowest layer extends 2.00 in below pile tip)

 Effective Unit Weight of Soil vs. Depth

Distribution of effective unit weight of soil with depth
 is defined using 20 points

Point No.	Depth X in	Eff. Unit Weight lbs/in**3
1	.00	.03160
2	36.00	.03160
3	36.00	.03330
4	180.00	.03330
5	180.00	.03160
6	204.00	.03160
7	204.00	.03480
8	276.00	.03480
9	276.00	.03250
10	516.00	.03250
11	516.00	.03620
12	612.00	.03620
13	612.00	.03550
14	828.00	.03550
15	828.00	.03110
16	1212.00	.03110
17	1212.00	.03040
18	1356.00	.03040
19	1356.00	.03450
20	1692.00	.03450

 Shear Strength of Soils

Distribution of shear strength parameters with depth
 defined using 20 points

Point	Depth X	Cohesion c	Angle of Friction	E50 or	RQD
-------	---------	------------	-------------------	--------	-----

No.	24 inch square precast concrete pile - stratum 8 through 10.1po in	lbs/in**2	Deg.	k_rm	10.1po %
1	.000	1.38890	15.00	.02000	.0
2	36.000	1.38890	15.00	.02000	.0
3	36.000	2.20140	.00	.02000	.0
4	180.000	2.20140	.00	.02000	.0
5	180.000	1.38890	15.00	.02000	.0
6	204.000	1.38890	15.00	.02000	.0
7	204.000	3.12500	.00	.02000	.0
8	276.000	3.12500	.00	.02000	.0
9	276.000	4.16670	.00	.01000	.0
10	516.000	7.63890	.00	.00700	.0
11	516.000	7.63890	.00	.00700	.0
12	612.000	7.63890	.00	.00700	.0
13	612.000	9.59030	.00	.00700	.0
14	828.000	9.59030	.00	.00700	.0
15	828.000	7.84720	.00	.00700	.0
16	1212.000	7.84720	.00	.00700	.0
17	1212.000	10.59030	.00	.00700	.0
18	1356.000	10.59030	.00	.00700	.0
19	1356.000	14.34720	.00	.00500	.0
20	1692.000	14.34720	.00	.00500	.0

Notes:

- (1) Cohesion = uniaxial compressive strength for rock materials.
- (2) Values of E50 are reported for clay strata.
- (3) Default values will be generated for E50 when input values are 0.
- (4) RQD and k_rm are reported only for weak rock strata.

Loading Type

Cyclic loading criteria was used for computation of p-y curves

Number of cycles of loading = 1000.

Pile-head Loading and Pile-head Fixity Conditions

Number of loads specified = 1

Load Case Number 1

Pile-head boundary conditions are Shear and Moment (BC Type 1)

Shear force at pile head = 1000.000 lbs
 Bending moment at pile head = 1000.000 in-lbs
 Axial load at pile head = 1000.000 lbs

Non-zero moment at pile head for this load case indicates the pile-head may rotate under the applied pile-head loading, but is not a free-head (zero moment) condition.

24 inch square precast concrete pile - stratum 8 through 10.1po

Output of p-y Curves at Specified Depths

p-y curves are generated and printed for verification at 8 depths.

Depth No.	Depth Below Pile Head in	Depth Below Ground Surface in
1	840.000	840.000
2	1020.000	1020.000
3	1200.000	1200.000
4	1224.000	1224.000
5	1284.000	1284.000
6	1344.000	1344.000
7	1524.000	1524.000
8	1690.000	1690.000

Depth of ground surface below top of pile = .00 in

p-y Curve Computed Using Cyclic Criteria for Stiff Clay without Free Water

Soil Layer Number = 8
 Depth below pile head = 840.000 in
 Depth below ground surface = 840.000 in
 Equivalent Depth = 628.800 in
 Diameter = 24.000 in
 Undrained cohesion, c = 7.84720 lbs/in**2
 Average Eff. Unit Weight = .03394 lbs/in**3
 Epsilon-50 = .00700
 Pct = 3544.419 lbs/in
 Pcd = 1694.995 lbs/in
 Pu = 1694.995 lbs/in
 y50 = .420 in
 p-multiplier = 1.00000
 y-multiplier = 1.00000
 Number of cycles of loading = 1000.

y, in	p, lbs/in
0.0000	0.0000
6.7200E-05	73.6850
.0003360	110.1847
.0006720	131.0325
.0033600	195.9393
.0067200	233.0124
.0336000	348.4347
.0672000	414.3611
.1680000	521.0315
.3360000	619.6143
.5040000	685.7160
.6720000	736.8498
1.6800	926.5396
3.3600	1101.8474
6.7200	1310.3248
15.1200	1604.8136
23.5200	1694.9952

p-y Curve Computed Using Cyclic Criteria for Stiff Clay without Free Water

24 inch square precast concrete pile - stratum 8 through 10.1po

Soil Layer Number = 8
 Depth below pile head = 1020.000 in
 Depth below ground surface = 1020.000 in
 Equivalent Depth = 808.800 in
 Diameter = 24.000 in
 Undrained cohesion, c = 7.84720 lbs/in**2
 Average Eff. Unit Weight = .03344 lbs/in**3
 Epsilon-50 = .00700
 Pct = 4387.563 lbs/in
 Pcd = 1694.995 lbs/in
 Pu = 1694.995 lbs/in
 y50 = .420 in
 p-multiplier = 1.00000
 y-multiplier = 1.00000
 Number of cycles of loading = 1000.

y, in	p, lbs/in
0.0000	0.0000
6.7200E-05	73.6850
.0003360	110.1847
.0006720	131.0325
.0033600	195.9393
.0067200	233.0124
.0336000	348.4347
.0672000	414.3611
.1680000	521.0315
.3360000	619.6143
.5040000	685.7160
.6720000	736.8498
1.6800	926.5396
3.3600	1101.8474
6.7200	1310.3248
15.1200	1604.8136
23.5200	1694.9952

p-y Curve Computed Using Cyclic Criteria for Stiff Clay without Free Water

Soil Layer Number = 8
 Depth below pile head = 1200.000 in
 Depth below ground surface = 1200.000 in
 Equivalent Depth = 988.800 in
 Diameter = 24.000 in
 Undrained cohesion, c = 7.84720 lbs/in**2
 Average Eff. Unit Weight = .03309 lbs/in**3
 Epsilon-50 = .00700
 Pct = 5229.944 lbs/in
 Pcd = 1694.995 lbs/in
 Pu = 1694.995 lbs/in
 y50 = .420 in
 p-multiplier = 1.00000
 y-multiplier = 1.00000
 Number of cycles of loading = 1000.

y, in	p, lbs/in
0.0000	0.0000
6.7200E-05	73.6850
.0003360	110.1847
.0006720	131.0325
.0033600	195.9393

24 inch square precast concrete pile - stratum 8 through 10.1po

.0067200	233.0124
.0336000	348.4347
.0672000	414.3611
.1680000	521.0315
.3360000	619.6143
.5040000	685.7160
.6720000	736.8498
1.6800	926.5396
3.3600	1101.8474
6.7200	1310.3248
15.1200	1604.8136
23.5200	1694.9952

p-y Curve Computed Using Cyclic Criteria for Stiff Clay without Free Water

Soil Layer Number	=	9
Depth below pile head	=	1224.000 in
Depth below ground surface	=	1224.000 in
Equivalent Depth	=	778.097 in
Diameter	=	24.000 in
Undrained cohesion, c	=	10.59030 lbs/in**2
Average Eff. Unit Weight	=	.03305 lbs/in**3
Epsilon-50	=	.00700
Pct	=	5499.734 lbs/in
Pcd	=	2287.505 lbs/in
Pu	=	2287.505 lbs/in
y50	=	.420 in
p-multiplier	=	1.00000
y-multiplier	=	1.00000
Number of cycles of loading	=	1000.

y, in	p, lbs/in
0.0000	0.0000
6.7200E-05	99.4426
.0003360	148.7014
.0006720	176.8367
.0033600	264.4326
.0067200	314.4651
.0336000	470.2351
.0672000	559.2069
.1680000	703.1654
.3360000	836.2093
.5040000	925.4177
.6720000	994.4261
1.6800	1250.4246
3.3600	1487.0138
6.7200	1768.3674
15.1200	2165.7989
23.5200	2287.5048

p-y Curve Computed Using Cyclic Criteria for Stiff Clay without Free Water

Soil Layer Number	=	9
Depth below pile head	=	1284.000 in
Depth below ground surface	=	1284.000 in
Equivalent Depth	=	838.097 in
Diameter	=	24.000 in

24 inch square precast concrete pile - stratum 8 through 10.1po

Undrained cohesion, c = 10.59030 lbs/in**2
 Average Eff. Unit Weight = .03292 lbs/in**3
 Epsilon-50 = .00700
 Pct = 5862.542 lbs/in
 Pcd = 2287.505 lbs/in
 Pu = 2287.505 lbs/in
 y50 = .420 in
 p-multiplier = 1.00000
 y-multiplier = 1.00000
 Number of cycles of loading = 1000.

y, in	p, lbs/in
0.0000	0.0000
6.7200E-05	99.4426
.0003360	148.7014
.0006720	176.8367
.0033600	264.4326
.0067200	314.4651
.0336000	470.2351
.0672000	559.2069
.1680000	703.1654
.3360000	836.2093
.5040000	925.4177
.6720000	994.4261
1.6800	1250.4246
3.3600	1487.0138
6.7200	1768.3674
15.1200	2165.7989
23.5200	2287.5048

p-y Curve Computed Using Cyclic Criteria for Stiff Clay without Free Water

Soil Layer Number = 9
 Depth below pile head = 1344.000 in
 Depth below ground surface = 1344.000 in
 Equivalent Depth = 898.097 in
 Diameter = 24.000 in
 Undrained cohesion, c = 10.59030 lbs/in**2
 Average Eff. Unit Weight = .03281 lbs/in**3
 Epsilon-50 = .00700
 Pct = 6225.232 lbs/in
 Pcd = 2287.505 lbs/in
 Pu = 2287.505 lbs/in
 y50 = .420 in
 p-multiplier = 1.00000
 y-multiplier = 1.00000
 Number of cycles of loading = 1000.

y, in	p, lbs/in
0.0000	0.0000
6.7200E-05	99.4426
.0003360	148.7014
.0006720	176.8367
.0033600	264.4326
.0067200	314.4651
.0336000	470.2351
.0672000	559.2069
.1680000	703.1654
.3360000	836.2093
.5040000	925.4177

24 inch square precast concrete pile - stratum 8 through 10.1po

.6720000	994.4261
1.6800	1250.4246
3.3600	1487.0138
6.7200	1768.3674
15.1200	2165.7989
23.5200	2287.5048

p-y Curve Computed Using Cyclic Criteria for Stiff Clay without Free Water

Soil Layer Number	=	10
Depth below pile head	=	1524.000 in
Depth below ground surface	=	1524.000 in
Equivalent Depth	=	861.118 in
Diameter	=	24.000 in
Undrained cohesion, c	=	14.34720 lbs/in**2
Average Eff. Unit Weight	=	.03298 lbs/in**3
Epsilon-50	=	.00500
Pct	=	7891.833 lbs/in
Pcd	=	3098.995 lbs/in
Pu	=	3098.995 lbs/in
y50	=	.300 in
p-multiplier	=	1.00000
y-multiplier	=	1.00000
Number of cycles of loading	=	1000.

y, in	p, lbs/in
0.0000	0.0000
4.8000E-05	134.7198
.0002400	201.4531
.0004800	239.5694
.0024000	358.2399
.0048000	426.0214
.0240000	637.0505
.0480000	757.5850
.1200000	952.6128
.2400000	1132.8539
.3600000	1253.7089
.4800000	1347.1979
1.2000	1694.0117
2.4000	2014.5307
4.8000	2395.6943
10.8000	2934.1143
16.8000	3098.9952

p-y Curve Computed Using Cyclic Criteria for Stiff Clay without Free Water

Soil Layer Number	=	10
Depth below pile head	=	1690.000 in
Depth below ground surface	=	1690.000 in
Equivalent Depth	=	1027.118 in
Diameter	=	24.000 in
Undrained cohesion, c	=	14.34720 lbs/in**2
Average Eff. Unit Weight	=	.03313 lbs/in**3
Epsilon-50	=	.00500
Pct	=	9217.718 lbs/in
Pcd	=	3098.995 lbs/in
Pu	=	3098.995 lbs/in

24 inch square precast concrete pile - stratum 8 through 10.1po

y50 = .300 in
 p-multiplier = 1.00000
 y-multiplier = 1.00000
 Number of cycles of loading = 1000.

y, in	p, lbs/in
0.0000	0.0000
4.8000E-05	134.7198
.0002400	201.4531
.0004800	239.5694
.0024000	358.2399
.0048000	426.0214
.0240000	637.0505
.0480000	757.5850
.1200000	952.6128
.2400000	1132.8539
.3600000	1253.7089
.4800000	1347.1979
1.2000	1694.0117
2.4000	2014.5307
4.8000	2395.6943
10.8000	2934.1143
16.8000	3098.9952

 Computed Values of Load Distribution and Deflection
 for Lateral Loading for Load Case Number 1

Pile-head boundary conditions are Shear and Moment (BC Type 1)
 Specified shear force at pile head = 1000.000 lbs
 Specified moment at pile head = 1000.000 in-lbs
 Specified axial load at pile head = 1000.000 lbs

Non-zero moment for this load case indicates the pile-head may rotate under the applied pile-head loading, but is not a free-head (zero moment) condition.

Depth Es*h	Deflect. y	Moment M	Shear V	Slope S	Total Stress	Soil Res. p
F/L in lbs/in	in	lbs-in	lbs	Rad.	lbs/in**2	lbs/in
0.000	.006565	1000.0000	1000.0000	-7.1641E-05	2.1701	0.0000
0.0000						
16.900	.005356	17901.2093	957.4742	-7.0038E-05	9.5057	-5.0326
15879.9160						
33.800	.004198	33364.9938	848.2856	-6.5692E-05	16.2174	-7.8891
31759.8320						
50.700	.003136	46575.4818	634.0616	-5.8915E-05	21.9512	-17.4629
94121.8447						
67.600	.002207	54798.2666	338.5890	-5.0320E-05	25.5201	-17.5043
134062.						
84.500	.001435	58021.4900	48.0918	-4.0756E-05	26.9190	-16.8741
198767.						
101.400	.000829	56425.1477	-225.3167	-3.1053E-05	26.2262	-15.4820

24 inch square precast concrete pile - stratum 8 through 10.1po

315591.						
118.300	.000385	50406.8343	-451.4965	-2.1996E-05	23.6141	-11.2849
495215.						
135.200	8.56E-05	41165.3102	-569.8322	-1.4233E-05	19.6030	-2.7194
536862.						
152.100	-9.59E-05	31146.9882	-565.0581	-8.1020E-06	15.2548	3.2844
578509.						
169.000	-.000188	22066.6204	-479.2543	-3.5906E-06	11.3136	6.8699
616768.						
185.900	-.000217	14948.3136	-404.2413	-4.5248E-07	8.2241	2.0073
156111.						
202.800	-.000204	8403.2806	-369.7760	1.5272E-06	5.3834	2.0714
171991.						
219.700	-.000166	2449.8332	-279.7408	2.4474E-06	2.7994	8.5837
875533.						
236.600	-.000121	-1052.0398	-154.3195	2.5659E-06	2.1927	6.2591
875533.						
253.500	-7.90E-05	-2766.2529	-66.8640	2.2421E-06	2.9367	4.0907
875533.						
270.400	-4.50E-05	-3312.1191	-12.5845	1.7268E-06	3.1737	2.3329
875533.						
287.300	-2.06E-05	-3191.6665	22.9425	1.1754E-06	3.1214	1.8714
1535789.						
304.200	-5.30E-06	-2536.7016	43.0882	6.8980E-07	2.8371	.5126621
1634263.						
321.100	2.72E-06	-1735.3081	45.0600	3.2762E-07	2.4893	-.2793107
1734362.						
338.000	5.77E-06	-1013.6835	37.4005	9.4567E-08	2.1761	-.6271429
1836160.						
354.900	5.92E-06	-471.1742	26.3614	-3.1318E-08	1.9406	-.6792572
1939740.						
371.800	4.71E-06	-122.6663	15.8015	-8.1663E-08	1.7894	-.5704368
2045190.						
388.700	3.16E-06	62.9196	7.5825	-8.6728E-08	1.7634	-.4022229
2152606.						
405.600	1.78E-06	133.6263	2.1679	-7.0065E-08	1.7941	-.2385603
2262088.						
422.500	7.90E-07	136.1975	-.7851124	-4.7190E-08	1.7952	-.1109107
2373749.						
439.400	1.87E-07	107.0911	-1.9552	-2.6564E-08	1.7826	-.0275659
2487708.						
456.300	-1.08E-07	70.1113	-2.0473	-1.1541E-08	1.7665	.0166766
2604096.						
473.200	-2.03E-07	37.8943	-1.6302	-2.3843E-09	1.7526	.0326791
2723054.						
490.100	-1.89E-07	15.0107	-1.0855	2.1010E-09	1.7426	.0317830
2844737.						
507.000	-1.32E-07	1.2046	-.6212443	3.4757E-09	1.7366	.0231576
2969314.						
523.900	-7.13E-08	-5.9874	-.2350657	3.0702E-09	1.7387	.0225440
5340698.						
540.800	-2.80E-08	-6.7407	.0302800	1.9911E-09	1.7390	.0088579
5340698.						
557.700	-4.04E-09	-4.9640	.1159103	9.9882E-10	1.7383	.0012759
5340698.						
574.600	5.73E-09	-2.8230	.1113894	3.3865E-10	1.7373	-.0018109
5340698.						
591.500	7.41E-09	-1.1991	.0763029	-2.3366E-12	1.7366	-.0023413
5340698.						
608.400	5.65E-09	-.2439170	.0414273	-1.2467E-10	1.7362	-.0017859
5340698.						
625.300	3.19E-09	.2011641	.0156249	-1.2830E-10	1.7362	-.0012676
6705010.						

24 inch square precast concrete pile - stratum 8 through 10.1po

642.200 6705010.	1.31E-09	.2842073	.0005052	-8.7148E-11	1.7362	-.0005217
659.100 6705010.	2.49E-10	.2182441	-.0047392	-4.4551E-11	1.7362	-9.8939E-05
676.000 6705010.	-1.91E-10	.1240224	-.0049355	-1.5534E-11	1.7362	7.5713E-05
692.900 6705010.	-2.76E-10	.0514248	-.0033716	-6.5930E-13	1.7361	.0001094
709.800 6705010.	-2.13E-10	.0100631	-.0017329	4.5536E-12	1.7361	8.4555E-05
726.700 6705010.	-1.22E-10	-.0071490	-.0006103	4.8006E-12	1.7361	4.8303E-05
743.600 6705010.	-5.09E-11	-.0105653	-3.1640E-05	3.2988E-12	1.7361	2.0178E-05
760.500 6705010.	-1.02E-11	-.0082185	.0001732	1.7064E-12	1.7361	4.0652E-06
777.400 6705010.	6.82E-12	-.0047107	.0001847	6.1024E-13	1.7361	-2.7043E-06
794.300 6705010.	1.04E-11	-.0019752	.0001271	4.3421E-14	1.7361	-4.1182E-06
811.200 6705010.	8.28E-12	-.0004159	6.4495E-05	-1.5929E-13	1.7361	-3.2865E-06
828.100 5486330.	5.00E-12	.0002047	2.3019E-05	-1.7719E-13	1.7361	-1.6218E-06
845.000 5486330.	2.29E-12	.0003622	3.0199E-06	-1.2913E-13	1.7361	-7.4492E-07
861.900 5486330.	6.31E-13	.0003068	-5.0061E-06	-7.2418E-14	1.7361	-2.0490E-07
878.800 5486330.	-1.53E-13	.0001930	-6.3176E-06	-3.0048E-14	1.7361	4.9699E-08
895.700 5486330.	-3.84E-13	9.3282E-05	-4.8430E-06	-5.7816E-15	1.7361	1.2481E-07
912.600 5486330.	-3.49E-13	2.9258E-05	-2.8324E-06	4.6072E-15	1.7361	1.1314E-07
929.500 5486330.	-2.29E-13	-2.4516E-06	-1.2489E-06	6.8799E-15	1.7361	7.4253E-08
946.400 5486330.	-1.16E-13	-1.2954E-05	-3.0332E-07	5.5738E-15	1.7361	3.7648E-08
963.300 5486330.	-4.03E-14	-1.2704E-05	1.2546E-07	3.3985E-15	1.7361	1.3094E-08
980.200 5486330.	-1.10E-15	-8.7138E-06	2.3912E-07	1.5828E-15	1.7361	3.5745E-10
997.100 5486330.	1.32E-14	-4.6216E-06	2.0604E-07	4.5221E-16	1.7361	-4.2731E-09
1014. 5486330.	1.42E-14	-1.7498E-06	1.3102E-07	-8.7948E-17	1.7361	-4.6045E-09
1031. 5486330.	1.02E-14	-1.9313E-07	6.4157E-08	-2.5267E-16	1.7361	-3.3081E-09
1048. 5486330.	5.64E-15	4.1872E-07	2.0723E-08	-2.3354E-16	1.7361	-1.8321E-09
1065. 5486330.	2.30E-15	5.0731E-07	-1.0581E-09	-1.5503E-16	1.7361	-7.4554E-10
1082. 5486330.	4.03E-16	3.8297E-07	-8.4644E-09	-7.9557E-17	1.7361	-1.3094E-10
1099. 5486330.	-3.92E-16	2.2122E-07	-8.4943E-09	-2.8335E-17	1.7361	1.2740E-10
1115. 5486330.	-5.54E-16	9.5860E-08	-5.8970E-09	-1.4529E-18	1.7361	1.7996E-10
1132. 5486330.	-4.42E-16	2.1900E-08	-3.1650E-09	8.5306E-18	1.7361	1.4335E-10
1149. 5486330.	-2.66E-16	-1.1118E-08	-1.2240E-09	9.4447E-18	1.7361	8.6359E-11
1166.	-1.22E-16	-1.9472E-08	-1.5869E-10	6.8513E-18	1.7361	3.9714E-11

24 inch square precast concrete pile - stratum 8 through 10.1po

5486330.	1183.	-3.44E-17	-1.6482E-08	2.7138E-10	3.8031E-18	1.7361	1.1182E-11
5486330.	1200.	6.21E-18	-1.0299E-08	3.4883E-10	1.5326E-18	1.7361	-2.0167E-12
5486330.	1217.	1.74E-17	-4.6921E-09	2.6753E-10	2.6167E-19	1.7361	-7.6045E-12
7404154.	1234.	1.51E-17	-1.2568E-09	1.4753E-10	-2.4268E-19	1.7361	-6.5966E-12
7404154.	1251.	9.15E-18	2.9438E-10	5.7896E-11	-3.2427E-19	1.7361	-4.0109E-12
7404154.	1268.	4.10E-18	7.0006E-10	8.8392E-12	-2.3996E-19	1.7361	-1.7947E-12
7404154.	1284.	1.04E-18	5.9315E-10	-1.0191E-11	-1.3033E-19	1.7361	-4.5739E-13
7404154.	1301.	-3.09E-19	3.5561E-10	-1.2913E-11	-4.9892E-20	1.7361	1.3524E-13
7404154.	1318.	-6.42E-19	1.5670E-10	-9.3921E-12	-6.4582E-21	1.7361	2.8142E-13
7404154.	1335.	-5.27E-19	3.8160E-11	-5.0632E-12	1.0062E-20	1.7361	2.3088E-13
7404154.	1352.	-3.02E-19	-1.4438E-11	-1.9933E-12	1.2073E-20	1.7361	1.3242E-13
7404154.	1369.	-1.19E-19	-2.9215E-11	-2.2566E-13	8.3722E-21	1.7361	7.6770E-14
1.0911E+07	1386.	-1.93E-20	-2.2066E-11	5.2820E-13	4.0247E-21	1.7361	1.2445E-14
1.0911E+07	1403.	1.71E-20	-1.1362E-11	5.3993E-13	1.1907E-21	1.7361	-1.1057E-14
1.0911E+07	1420.	2.10E-20	-3.8161E-12	3.3209E-13	-9.6046E-23	1.7361	-1.3539E-14
1.0911E+07	1436.	1.39E-20	-1.3733E-13	1.4196E-13	-4.3122E-22	1.7361	-8.9612E-15
1.0911E+07	1453.	6.40E-21	9.8206E-13	3.1344E-14	-3.5960E-22	1.7361	-4.1292E-15
1.0911E+07	1470.	1.73E-21	9.2210E-13	-1.2961E-14	-1.9817E-22	1.7361	-1.1140E-15
1.0911E+07	1487.	-3.02E-22	5.4398E-13	-2.0724E-14	-7.3876E-23	1.7361	1.9527E-16
1.0911E+07	1504.	-7.72E-22	2.2162E-13	-1.4865E-14	-8.9687E-24	1.7361	4.9813E-16
1.0911E+07	1521.	-6.06E-22	4.1540E-14	-7.3521E-15	1.3342E-23	1.7361	3.9098E-16
1.0911E+07	1538.	-3.21E-22	-2.6877E-14	-2.2993E-15	1.4585E-23	1.7361	2.0698E-16
1.0911E+07	1555.	-1.13E-22	-3.6177E-14	6.4021E-17	9.2395E-24	1.7361	7.2702E-17
1.0911E+07	1572.	-8.29E-24	-2.4713E-14	7.2360E-16	4.0773E-24	1.7361	5.3543E-18
1.0911E+07	1589.	2.52E-23	-1.1720E-14	6.3133E-16	9.8860E-25	1.7361	-1.6273E-17
1.0911E+07	1605.	2.51E-23	-3.3740E-15	3.5677E-16	-2.9102E-25	1.7361	-1.6219E-17
1.0911E+07	1622.	1.54E-23	3.3937E-16	1.3588E-16	-5.4829E-25	1.7361	-9.9227E-18
1.0911E+07	1639.	6.59E-24	1.2187E-15	1.6083E-17	-4.1620E-25	1.7361	-4.2542E-18
1.0911E+07	1656.	1.30E-24	8.8299E-16	-2.6965E-17	-2.3802E-25	1.7361	-8.4034E-19
1.0911E+07	1673.	-1.46E-24	3.0727E-16	-2.6124E-17	-1.3711E-25	1.7361	9.3991E-19
1.0911E+07	1690.	-3.33E-24	0.0000	0.0000	-1.1106E-25	1.7361	2.1517E-18
5455523.							

24 inch square precast concrete pile - stratum 8 through 10.1po

Output Verification:

Computed forces and moments are within specified convergence limits.

Output Summary for Load Case No. 1:

Pile-head deflection = .00656522 in
 Computed slope at pile head = -.00007164
 Maximum bending moment = 58021.49000 lbs-in
 Maximum shear force = 1000.00000 lbs
 Depth of maximum bending moment = 84.50000000 in
 Depth of maximum shear force = 0.00000 in
 Number of iterations = 9
 Number of zero deflection points = 15

 Summary of Pile Response(s)

Definition of Symbols for Pile-Head Loading Conditions:

Type 1 = Shear and Moment, y = pile-head displacement in
 Type 2 = Shear and Slope, M = Pile-head Moment lbs-in
 Type 3 = Shear and Rot. Stiffness, V = Pile-head Shear Force lbs
 Type 4 = Deflection and Moment, S = Pile-head Slope, radians
 Type 5 = Deflection and Slope, R = Rot. Stiffness of Pile-head in-lbs/rad

Load Type	Pile-Head Condition 1	Pile-Head Condition 2	Axial Load lbs	Pile-Head Deflection in	Maximum Moment in-lbs	Maximum Shear lbs
1	V= 1000.000	M= 1000.000	1000.0000	.0065652	58021.4900	1000.0000

The analysis ended normally.

12 inch pipe - stratum 1 through 4.lpo

LPILE Plus for windows, Version 5.0 (5.0.30)

Analysis of Individual Piles and Drilled Shafts
Subjected to Lateral Loading Using the p-y Method

(c) 1985-2007 by Ensoft, Inc.
All Rights Reserved

This program is licensed to:

DJI
Eustis

Path to file locations: U:\sys\WPDATA\Projects\20749\Piles\LPile\
Name of input data file: 12 inch pipe - stratum 1 through 4.lpd
Name of output file: 12 inch pipe - stratum 1 through 4.lpo
Name of plot output file: 12 inch pipe - stratum 1 through 4.lpp
Name of runtime file: 12 inch pipe - stratum 1 through 4.lpr

Time and Date of Analysis

Date: November 9, 2009 Time: 18:27:23

Problem Title

EE20749 - St. Mary Floodgate Structure at Franklin Drainage Canal

Program Options

Units Used in Computations - US Customary Units: Inches, Pounds

Basic Program Options:

Analysis Type 1:

- Computation of Lateral Pile Response Using User-specified Constant EI

Computation Options:

- Only internally-generated p-y curves used in analysis
- Analysis does not use p-y multipliers (individual pile or shaft action only)
- Analysis assumes no shear resistance at pile tip
- Analysis for fixed-length pile or shaft only
- No computation of foundation stiffness matrix elements
- Output pile response for full length of pile
- Analysis assumes no soil movements acting on pile
- Additional p-y curves computed at specified depths

Solution Control Parameters:

- Number of pile increments = 100
- Maximum number of iterations allowed = 100

12 inch pipe - stratum 1 through 4.lpo

- Deflection tolerance for convergence = 1.0000E-05 in
- Maximum allowable deflection = 1.0000E+02 in

Printing Options:

- Values of pile-head deflection, bending moment, shear force, and soil reaction are printed for full length of pile.
- Printing Increment (spacing of output points) = 1

Pile Structural Properties and Geometry

Pile Length = 1690.00 in
Depth of ground surface below top of pile = .00 in
Slope angle of ground surface = .00 deg.

Structural properties of pile defined using 2 points

Point	Depth X in	Pile Diameter in	Moment of Inertia in**4	Pile Area Sq.in	Modulus of Elasticity lbs/Sq.in
1	0.0000	12.00000000	299.2000	18.0600	30000.00000
2	1690.0000	12.00000000	299.2000	18.0600	30000.00000

Soil and Rock Layering Information

The soil profile is modelled using 10 layers

Layer 1 is silt with cohesion and friction
Distance from top of pile to top of layer = .000 in
Distance from top of pile to bottom of layer = 36.000 in
p-y subgrade modulus k for top of soil layer = 55.600 lbs/in**3
p-y subgrade modulus k for bottom of layer = 55.600 lbs/in**3

Layer 2 is soft clay, p-y criteria by Matlock, 1970
Distance from top of pile to top of layer = 36.000 in
Distance from top of pile to bottom of layer = 180.000 in

Layer 3 is silt with cohesion and friction
Distance from top of pile to top of layer = 180.000 in
Distance from top of pile to bottom of layer = 204.000 in
p-y subgrade modulus k for top of soil layer = 55.600 lbs/in**3
p-y subgrade modulus k for bottom of layer = 55.600 lbs/in**3

Layer 4 is soft clay, p-y criteria by Matlock, 1970
Distance from top of pile to top of layer = 204.000 in
Distance from top of pile to bottom of layer = 276.000 in

Layer 5 is soft clay, p-y criteria by Matlock, 1970
Distance from top of pile to top of layer = 276.000 in
Distance from top of pile to bottom of layer = 516.000 in

Layer 6 is stiff clay without free water
Distance from top of pile to top of layer = 516.000 in
Distance from top of pile to bottom of layer = 612.000 in

Layer 7 is stiff clay without free water
Distance from top of pile to top of layer = 612.000 in

12 inch pipe - stratum 1 through 4.1po
 Distance from top of pile to bottom of layer = 828.000 in
 Layer 8 is stiff clay without free water
 Distance from top of pile to top of layer = 828.000 in
 Distance from top of pile to bottom of layer = 1212.000 in
 Layer 9 is stiff clay without free water
 Distance from top of pile to top of layer = 1212.000 in
 Distance from top of pile to bottom of layer = 1356.000 in
 Layer 10 is stiff clay without free water
 Distance from top of pile to top of layer = 1356.000 in
 Distance from top of pile to bottom of layer = 1692.000 in

(Depth of lowest layer extends 2.00 in below pile tip)

 Effective Unit Weight of Soil vs. Depth

Distribution of effective unit weight of soil with depth
 is defined using 20 points

Point No.	Depth X in	Eff. Unit Weight lbs/in**3
1	.00	.03160
2	36.00	.03160
3	36.00	.03330
4	180.00	.03330
5	180.00	.03160
6	204.00	.03160
7	204.00	.03480
8	276.00	.03480
9	276.00	.03250
10	516.00	.03250
11	516.00	.03620
12	612.00	.03620
13	612.00	.03550
14	828.00	.03550
15	828.00	.03110
16	1212.00	.03110
17	1212.00	.03040
18	1356.00	.03040
19	1356.00	.03450
20	1692.00	.03450

 Shear Strength of Soils

Distribution of shear strength parameters with depth
 defined using 20 points

Point No.	Depth X in	Cohesion c lbs/in**2	Angle of Friction Deg.	E50 or k _{rm}	RQD %
1	.000	1.38890	15.00	.02000	.0
2	36.000	1.38890	15.00	.02000	.0

12 inch pipe - stratum 1 through 4.1po						
3	36.000	2.20140	.00	.02000	.0	
4	180.000	2.20140	.00	.02000	.0	
5	180.000	1.38890	15.00	.02000	.0	
6	204.000	1.38890	15.00	.02000	.0	
7	204.000	3.12500	.00	.02000	.0	
8	276.000	3.12500	.00	.02000	.0	
9	276.000	4.16670	.00	.01000	.0	
10	516.000	7.63890	.00	.00700	.0	
11	516.000	7.63890	.00	.00700	.0	
12	612.000	7.63890	.00	.00700	.0	
13	612.000	9.59030	.00	.00700	.0	
14	828.000	9.59030	.00	.00700	.0	
15	828.000	7.84720	.00	.00700	.0	
16	1212.000	7.84720	.00	.00700	.0	
17	1212.000	10.59030	.00	.00700	.0	
18	1356.000	10.59030	.00	.00700	.0	
19	1356.000	14.34720	.00	.00500	.0	
20	1692.000	14.34720	.00	.00500	.0	

Notes:

- (1) Cohesion = uniaxial compressive strength for rock materials.
- (2) Values of E50 are reported for clay strata.
- (3) Default values will be generated for E50 when input values are 0.
- (4) RQD and k_{rm} are reported only for weak rock strata.

Loading Type

Cyclic loading criteria was used for computation of p-y curves

Number of cycles of loading = 1000.

Pile-head Loading and Pile-head Fixity Conditions

Number of loads specified = 1

Load Case Number 1

Pile-head boundary conditions are Shear and Moment (BC Type 1)

Shear force at pile head = 1000.000 lbs
 Bending moment at pile head = 1000.000 in-lbs
 Axial load at pile head = 1000.000 lbs

Non-zero moment at pile head for this load case indicates the pile-head may rotate under the applied pile-head loading, but is not a free-head (zero moment) condition.

Output of p-y Curves at Specified Depths

12 inch pipe - stratum 1 through 4.lpo

p-y curves are generated and printed for verification at 8 depths.

Depth No.	Depth Below Pile Head in	Depth Below Ground Surface in
1	18.000	18.000
2	48.000	48.000
3	108.000	108.000
4	168.000	168.000
5	192.000	192.000
6	216.000	216.000
7	240.000	240.000
8	264.000	264.000

Depth of ground surface below top of pile = .00 in

Eq.	3.65	12.1335
Eq.	3.66	31.5308
Eq.	3.67	4.1595
Eq.	3.67	69.3261
Eq.	3.69	82.7942
Eq.	3.75	-3.8770
Eq.	3.76	80.6769
Eq.	3.77	.1351

p-y Curve Computed Using the Cyclic Criteria for Cemented Silt

Soil Layer Number	=	1
Depth below pile head	=	18.000 in
Depth below ground surface	=	18.000in
Equivalent Depth	=	18.000in
Pile Diameter	=	12.000in
Cohesion, c	=	1.389lbs/in**2
Angle of Friction	=	15.000 deg.
Avg. Eff. Unit Weight	=	.03160lbs/in**3
k (internal default)	=	55.600lbs/in**3
E50 (internal default)	=	.02000
A parameter	=	1.11000
B parameter	=	.86000
Pu	=	69.326lbs/in
Pc	=	12.133lbs/in
Number of Cycles of Loading	=	1000.
p-multiplier	=	1.00000
y-multiplier	=	1.00000
Pu,c	=	69.326lbs/in
Pc,phi	=	12.133lbs/in

y, in	p, lbs/in
0.0000	0.0000
.0166667	16.6800
.0333333	33.3600
.0500000	50.0400
.0666667	66.7200
.0833333	83.4000
.1000000	100.0800
.1166667	116.7600
.1333333	133.4400
.1500000	131.6008
.1666667	128.0726
.1833333	124.9626

	12 inch pipe - stratum 1 through 4.lpo
.2000000	122.1893
.4500000	82.7942
12.4500	82.7942
24.4500	82.7942
36.4500	82.7942

p-y Curve Computed Using the Soft Clay Criteria for Cyclic Loading Conditions

Soil Layer Number	=	2
Depth below pile head	=	48.000 in
Depth below ground surface	=	48.000 in
Equivalent Depth	=	41.697 in
Pile Diameter	=	12.000 in
Cohesion, c	=	2.201 lbs/in**2
Avg Eff Unit weight	=	.03203 lbs/in**3
E50 parameter	=	.02000
Default J parameter	=	.500
Y50	=	.60000 in
p-multiplier	=	1.00000
y-multiplier	=	1.00000
Number of cycles of loading	=	1000.
Xr	=	106.735 in

y, in	p, lbs/in
0.0000	0.0000
.0048000	15.0530
.1500000	47.4141
.3000000	59.7380
.4500000	68.3830
.6000000	75.2652
.7500000	81.0770
.9000000	86.1571
1.0500	90.6999
1.2000	94.8282
1.3500	98.6253
1.5000	102.1506
1.6500	105.4480
1.8000	108.5512
4.8000	80.8645
9.0000	42.3401
12.0000	42.3401

p-y Curve Computed Using the Soft Clay Criteria for Cyclic Loading Conditions

Soil Layer Number	=	2
Depth below pile head	=	108.000 in
Depth below ground surface	=	108.000 in
Equivalent Depth	=	101.697 in
Pile Diameter	=	12.000 in
Cohesion, c	=	2.201 lbs/in**2
Avg Eff Unit weight	=	.03273 lbs/in**3
E50 parameter	=	.02000
Default J parameter	=	.500
Y50	=	.60000 in
p-multiplier	=	1.00000
y-multiplier	=	1.00000
Number of cycles of loading	=	1000.

Xr 12 inch pipe - stratum 1 through 4.lpo
= 106.127 in

y, in	p, lbs/in
0.0000	0.0000
.0048000	23.7751
.1500000	74.8869
.3000000	94.3516
.4500000	108.0057
.6000000	118.8756
.7500000	128.0549
.9000000	136.0786
1.0500	143.2536
1.2000	149.7739
1.3500	155.7711
1.5000	161.3390
1.6500	166.5471
1.8000	171.4483
4.8000	168.2032
9.0000	164.0345
12.0000	164.0345

p-y Curve Computed Using the Soft Clay Criteria for Cyclic Loading Conditions

Soil Layer Number = 2
Depth below pile head = 168.000 in
Depth below ground surface = 168.000 in
Equivalent Depth = 161.697 in
Pile Diameter = 12.000 in
Cohesion, c = 2.201 lbs/in**2
Avg Eff Unit Weight = .03294 lbs/in**3
E50 parameter = .02000
Default J parameter = .500
Y50 = .60000 in
p-multiplier = 1.00000
y-multiplier = 1.00000
Number of cycles of loading = 1000.
Xr = 105.955 in

y, in	p, lbs/in
0.0000	0.0000
.0048000	23.7751
.1500000	74.8869
.3000000	94.3516
.4500000	108.0057
.6000000	118.8756
.7500000	128.0549
.9000000	136.0786
1.0500	143.2536
1.2000	149.7739
1.3500	155.7711
1.5000	161.3390
1.6500	166.5471
1.8000	171.4483
4.8000	171.1809
9.0000	171.1809
12.0000	171.1809

Eq. 3.65 348.6908

12 inch pipe - stratum 1 through 4.1po

Eq. 3.66 349.8982
 Eq. 3.67 12.1535
 Eq. 3.68 150.0012
 Eq. 3.69 456.8491
 Eq. 3.75 -3.2111
 Eq. 3.76 453.1616
 Eq. 3.77 .1143

p-y Curve Computed Using the Cyclic Criteria for Cemented Silt

Soil Layer Number = 3
 Depth below pile head = 192.000 in
 Depth below ground surface = 192.000in
 Equivalent Depth = 140.097in
 Pile Diameter = 12.000in
 Cohesion, c = 1.389lbs/in**2
 Angle of Friction = 15.000 deg.
 Avg. Eff. Unit Weight = .03288lbs/in**3
 k (internal default) = 55.600lbs/in**3
 E50 (internal default) = .02000
 A parameter = .88000
 B parameter = .55000
 Pu = 150.001lbs/in
 Pc = 348.691lbs/in
 Number of Cycles of Loading = 1000.
 p-multiplier = 1.00000
 y-multiplier = 1.00000
 Pu,c = 150.001lbs/in
 Pc,phi = 348.691lbs/in

y, in	p, lbs/in
0.0000	0.0000
.0166667	129.8236
.0333333	259.6473
.0500000	389.4709
.0666667	519.2945
.0833333	649.1181
.1000000	778.9418
.1166667	884.7508
.1333333	848.7139
.1500000	818.1475
.1666667	791.7389
.1833333	768.5845
.2000000	748.0380
.4500000	456.8491
12.4500	456.8491
24.4500	456.8491
36.4500	456.8491

p-y Curve Computed Using the Soft Clay Criteria for Cyclic Loading Conditions

Soil Layer Number = 4
 Depth below pile head = 216.000 in
 Depth below ground surface = 216.000 in
 Equivalent Depth = 240.977 in
 Pile Diameter = 12.000 in
 Cohesion, c = 3.125 lbs/in**2

12 inch pipe - stratum 1 through 4.lpo

```

Avg Eff Unit Weight = .03291 lbs/in**3
E50 parameter = .02000
Default J parameter = .500
Y50 = .60000 in
p-multiplier = 1.00000
y-multiplier = 1.00000
Number of cycles of loading = 1000.
Xr = 114.946 in

```

y, in	p, lbs/in
0.0000	0.0000
.0048000	33.7500
.1500000	106.3058
.3000000	133.9370
.4500000	153.3195
.6000000	168.7500
.7500000	181.7804
.9000000	193.1705
1.0500	203.3558
1.2000	212.6117
1.3500	221.1251
1.5000	229.0290
1.6500	236.4221
1.8000	243.3796
4.8000	243.0000
9.0000	243.0000
12.0000	243.0000

p-y Curve Computed Using the Soft Clay Criteria for Cyclic Loading Conditions

```

Soil Layer Number = 4
Depth below pile head = 240.000 in
Depth below ground surface = 240.000 in
Equivalent Depth = 264.977 in
Pile Diameter = 12.000 in
Cohesion, c = 3.125 lbs/in**2
Avg Eff Unit Weight = .03310 lbs/in**3
E50 parameter = .02000
Default J parameter = .500
Y50 = .60000 in
p-multiplier = 1.00000
y-multiplier = 1.00000
Number of cycles of loading = 1000.
Xr = 114.813 in

```

y, in	p, lbs/in
0.0000	0.0000
.0048000	33.7500
.1500000	106.3058
.3000000	133.9370
.4500000	153.3195
.6000000	168.7500
.7500000	181.7804
.9000000	193.1705
1.0500	203.3558
1.2000	212.6117
1.3500	221.1251
1.5000	229.0290
1.6500	236.4221
1.8000	243.3796

12 inch pipe - stratum 1 through 4.lpo
 4.8000 243.0000
 9.0000 243.0000
 12.0000 243.0000

p-y Curve Computed Using the Soft Clay Criteria for Cyclic Loading Conditions

Soil Layer Number = 4
 Depth below pile head = 264.000 in
 Depth below ground surface = 264.000 in
 Equivalent Depth = 288.977 in
 Pile Diameter = 12.000 in
 Cohesion, c = 3.125 lbs/in**2
 Avg Eff Unit Weight = .03325 lbs/in**3
 E50 parameter = .02000
 Default J parameter = .500
 Y50 = .60000 in
 p-multiplier = 1.00000
 y-multiplier = 1.00000
 Number of cycles of loading = 1000.
 Xr = 114.705 in

y, in	p, lbs/in
0.0000	0.0000
.0048000	33.7500
.1500000	106.3058
.3000000	133.9370
.4500000	153.3195
.6000000	168.7500
.7500000	181.7804
.9000000	193.1705
1.0500	203.3558
1.2000	212.6117
1.3500	221.1251
1.5000	229.0290
1.6500	236.4221
1.8000	243.3796
4.8000	243.0000
9.0000	243.0000
12.0000	243.0000

 Computed Values of Load Distribution and Deflection
 for Lateral Loading for Load Case Number 1

Pile-head boundary conditions are Shear and Moment (BC Type 1)
 Specified shear force at pile head = 1000.000 lbs
 Specified moment at pile head = 1000.000 in-lbs
 Specified axial load at pile head = 1000.000 lbs

Non-zero moment for this load case indicates the pile-head may rotate under the applied pile-head loading, but is not a free-head (zero moment) condition.

Depth	Deflect.	Moment	Shear	Slope	Total	Soil Res.
Es*h	y	M	V	S	Stress	p
F/L	X					

in lbs/in	in	12 inch lbs-in	pipe - stratum 1 through lbs	4.1po Rad.	4.1po lbs/in**2	lbs/in
0.000	.842040	1000.0000	1000.0000	-.0439100	75.4245	0.0000
0.0000						
16.900	.115870	18626.1695	79.9959	-.0254339	428.8904	-108.8762
15879.9160						
33.800	-.017628	4563.5284	-560.0804	-.0036032	146.8856	33.1276
31759.8320						
50.700	-.005917	-182.7611	-139.9365	.0005209	59.0360	16.5936
47390.5810						
67.600	-2.25E-05	-183.9316	5.5251	.0001757	59.0595	.6207744
466786.						
84.500	1.99E-05	-1.9501	5.4604	6.7410E-07	55.4101	-.6284370
532561.						
101.400	3.09E-07	.6055504	.0574929	-5.9165E-07	55.3831	-.0109547
598337.						
118.300	-5.55E-08	.0131604	-.0179734	-9.2006E-09	55.3712	.0020238
616768.						
135.200	-1.57E-09	-.0016397	-.0003894	1.6449E-09	55.3710	5.7174E-05
616768.						
152.100	1.46E-10	-5.8207E-05	4.8681E-05	4.6537E-11	55.3710	-5.3254E-06
616768.						
169.000	6.34E-12	4.1359E-06	1.7266E-06	-4.3660E-12	55.3710	-2.3126E-07
616768.						
185.900	-1.65E-12	2.9784E-07	-1.2379E-07	-1.9211E-13	55.3710	1.2282E-08
125909.						
202.800	-1.57E-13	-4.1897E-08	-8.9123E-09	4.8835E-14	55.3710	1.3139E-09
141789.						
219.700	2.16E-15	-5.0463E-09	1.2456E-09	4.6434E-15	55.3710	-1.1176E-10
875533.						
236.600	3.46E-16	4.5969E-11	1.4956E-10	-6.3871E-17	55.3710	-1.7947E-11
875533.						
253.500	-1.65E-18	1.0967E-11	-1.3704E-12	-1.0271E-17	55.3710	8.5353E-14
875533.						
270.400	-7.40E-19	-5.2916E-15	-3.2511E-13	4.8698E-20	55.3710	3.8355E-14
875533.						
287.300	-1.55E-21	-2.3144E-14	1.7551E-16	2.1928E-20	55.3710	1.4061E-16
1535789.						
304.200	8.30E-22	-1.0063E-16	6.8554E-16	4.5930E-23	55.3710	-8.0250E-17
1634263.						
321.100	5.15E-24	2.5731E-17	2.9588E-18	-2.4577E-23	55.3710	-5.2889E-19
1734362.						
338.000	-8.15E-25	2.1294E-19	-7.6217E-19	-1.5271E-25	55.3710	8.8537E-20
1836160.						
354.900	0.000	-2.5085E-20	-6.2845E-21	0.0000	55.3710	9.1738E-22
1939740.						
371.800	0.000	-2.9542E-22	7.4305E-22	0.0000	55.3710	-8.5719E-23
2045190.						
388.700	0.000	2.1660E-23	8.7289E-24	0.0000	55.3710	-1.1825E-24
2152606.						
405.600	0.000	3.2601E-25	-6.4160E-25	0.0000	55.3710	0.0000
2262088.						
422.500	0.000	0.0000	0.0000	0.0000	55.3710	0.0000
2373749.						
439.400	0.000	0.0000	0.0000	0.0000	55.3710	0.0000
2487708.						
456.300	0.000	0.0000	0.0000	0.0000	55.3710	0.0000
2604096.						
473.200	0.000	0.0000	0.0000	0.0000	55.3710	0.0000
2723054.						
490.100	0.000	0.0000	0.0000	0.0000	55.3710	0.0000

12 inch pipe - stratum 1 through 4.lpo

2844737.						
507.000	0.000	0.0000	0.0000	0.0000	55.3710	0.0000
2969314.						
523.900	0.000	0.0000	0.0000	0.0000	55.3710	0.0000
5340698.						
540.800	0.000	0.0000	0.0000	0.0000	55.3710	0.0000
5340698.						
557.700	0.000	0.0000	0.0000	0.0000	55.3710	0.0000
5340698.						
574.600	0.000	0.0000	0.0000	0.0000	55.3710	0.0000
5340698.						
591.500	0.000	0.0000	0.0000	0.0000	55.3710	0.0000
5340698.						
608.400	0.000	0.0000	0.0000	0.0000	55.3710	0.0000
5340698.						
625.300	0.000	0.0000	0.0000	0.0000	55.3710	0.0000
6705010.						
642.200	0.000	0.0000	0.0000	0.0000	55.3710	0.0000
6705010.						
659.100	0.000	0.0000	0.0000	0.0000	55.3710	0.0000
6705010.						
676.000	0.000	0.0000	0.0000	0.0000	55.3710	0.0000
6705010.						
692.900	0.000	0.0000	0.0000	0.0000	55.3710	0.0000
6705010.						
709.800	0.000	0.0000	0.0000	0.0000	55.3710	0.0000
6705010.						
726.700	0.000	0.0000	0.0000	0.0000	55.3710	0.0000
6705010.						
743.600	0.000	0.0000	0.0000	0.0000	55.3710	0.0000
6705010.						
760.500	0.000	0.0000	0.0000	0.0000	55.3710	0.0000
6705010.						
777.400	0.000	0.0000	0.0000	0.0000	55.3710	0.0000
6705010.						
794.300	0.000	0.0000	0.0000	0.0000	55.3710	0.0000
6705010.						
811.200	0.000	0.0000	0.0000	0.0000	55.3710	0.0000
6705010.						
828.100	0.000	0.0000	0.0000	0.0000	55.3710	0.0000
5486330.						
845.000	0.000	0.0000	0.0000	0.0000	55.3710	0.0000
5486330.						
861.900	0.000	0.0000	0.0000	0.0000	55.3710	0.0000
5486330.						
878.800	0.000	0.0000	0.0000	0.0000	55.3710	0.0000
5486330.						
895.700	0.000	0.0000	0.0000	0.0000	55.3710	0.0000
5486330.						
912.600	0.000	0.0000	0.0000	0.0000	55.3710	0.0000
5486330.						
929.500	0.000	0.0000	0.0000	0.0000	55.3710	0.0000
5486330.						
946.400	0.000	0.0000	0.0000	0.0000	55.3710	0.0000
5486330.						
963.300	0.000	0.0000	0.0000	0.0000	55.3710	0.0000
5486330.						
980.200	0.000	0.0000	0.0000	0.0000	55.3710	0.0000
5486330.						
997.100	0.000	0.0000	0.0000	0.0000	55.3710	0.0000
5486330.						
1014.	0.000	0.0000	0.0000	0.0000	55.3710	0.0000
5486330.						

		12 inch pipe - stratum 1 through 4.1po				
1031.	0.000	0.0000	0.0000	0.0000	55.3710	0.0000
5486330.						
1048.	0.000	0.0000	0.0000	0.0000	55.3710	0.0000
5486330.						
1065.	0.000	0.0000	0.0000	0.0000	55.3710	0.0000
5486330.						
1082.	0.000	0.0000	0.0000	0.0000	55.3710	0.0000
5486330.						
1099.	0.000	0.0000	0.0000	0.0000	55.3710	0.0000
5486330.						
1115.	0.000	0.0000	0.0000	0.0000	55.3710	0.0000
5486330.						
1132.	0.000	0.0000	0.0000	0.0000	55.3710	0.0000
5486330.						
1149.	0.000	0.0000	0.0000	0.0000	55.3710	0.0000
5486330.						
1166.	0.000	0.0000	0.0000	0.0000	55.3710	0.0000
5486330.						
1183.	0.000	0.0000	0.0000	0.0000	55.3710	0.0000
5486330.						
1200.	0.000	0.0000	0.0000	0.0000	55.3710	0.0000
5486330.						
1217.	0.000	0.0000	0.0000	0.0000	55.3710	0.0000
7404154.						
1234.	0.000	0.0000	0.0000	0.0000	55.3710	0.0000
7404154.						
1251.	0.000	0.0000	0.0000	0.0000	55.3710	0.0000
7404154.						
1268.	0.000	0.0000	0.0000	0.0000	55.3710	0.0000
7404154.						
1284.	0.000	0.0000	0.0000	0.0000	55.3710	0.0000
7404154.						
1301.	0.000	0.0000	0.0000	0.0000	55.3710	0.0000
7404154.						
1318.	0.000	0.0000	0.0000	0.0000	55.3710	0.0000
7404154.						
1335.	0.000	0.0000	0.0000	0.0000	55.3710	0.0000
7404154.						
1352.	0.000	0.0000	0.0000	0.0000	55.3710	0.0000
7404154.						
1369.	0.000	0.0000	0.0000	0.0000	55.3710	0.0000
1.0911E+07						
1386.	0.000	0.0000	0.0000	0.0000	55.3710	0.0000
1.0911E+07						
1403.	0.000	0.0000	0.0000	0.0000	55.3710	0.0000
1.0911E+07						
1420.	0.000	0.0000	0.0000	0.0000	55.3710	0.0000
1.0911E+07						
1436.	0.000	0.0000	0.0000	0.0000	55.3710	0.0000
1.0911E+07						
1453.	0.000	0.0000	0.0000	0.0000	55.3710	0.0000
1.0911E+07						
1470.	0.000	0.0000	0.0000	0.0000	55.3710	0.0000
1.0911E+07						
1487.	0.000	0.0000	0.0000	0.0000	55.3710	0.0000
1.0911E+07						
1504.	0.000	0.0000	0.0000	0.0000	55.3710	0.0000
1.0911E+07						
1521.	0.000	0.0000	0.0000	0.0000	55.3710	0.0000
1.0911E+07						
1538.	0.000	0.0000	0.0000	0.0000	55.3710	0.0000
1.0911E+07						
1555.	0.000	0.0000	0.0000	0.0000	55.3710	0.0000

12 inch pipe - stratum 1 through 4.1po

1.0911E+07						
1572.	0.000	0.0000	0.0000	0.0000	55.3710	0.0000
1.0911E+07						
1589.	0.000	0.0000	0.0000	0.0000	55.3710	0.0000
1.0911E+07						
1605.	0.000	0.0000	0.0000	0.0000	55.3710	0.0000
1.0911E+07						
1622.	0.000	0.0000	0.0000	0.0000	55.3710	0.0000
1.0911E+07						
1639.	0.000	0.0000	0.0000	0.0000	55.3710	0.0000
1.0911E+07						
1656.	0.000	0.0000	0.0000	0.0000	55.3710	0.0000
1.0911E+07						
1673.	0.000	0.0000	0.0000	0.0000	55.3710	0.0000
1.0911E+07						
1690.	0.000	0.0000	0.0000	0.0000	55.3710	0.0000
5455523.						

Output Verification:

Computed forces and moments are within specified convergence limits.

Output Summary for Load Case No. 1:

Pile-head deflection = .84203969 in
 Computed slope at pile head = -.04391001
 Maximum bending moment = 18626.16954 lbs-in
 Maximum shear force = 1000.00000 lbs
 Depth of maximum bending moment = 16.90000000 in
 Depth of maximum shear force = 0.00000 in
 Number of iterations = 14
 Number of zero deflection points = 49

 Summary of Pile Response(s)

Definition of Symbols for Pile-Head Loading Conditions:

Type 1 = Shear and Moment, y = pile-head displacement in
 Type 2 = Shear and Slope, M = Pile-head Moment lbs-in
 Type 3 = Shear and Rot. Stiffness, V = Pile-head Shear Force lbs
 Type 4 = Deflection and Moment, S = Pile-head Slope, radians
 Type 5 = Deflection and Slope, R = Rot. Stiffness of Pile-head in-lbs/rad

Load Type	Pile-Head Condition 1	Pile-Head Condition 2	Axial Load lbs	Pile-Head Deflection in	Maximum Moment in-lbs	Maximum Shear lbs
1	V= 1000.000	M= 1000.000	1000.0000	.8420397	18626.1695	1000.0000

The analysis ended normally.

12 inch pipe - stratum 5 through 7.lpo

LPILE Plus for windows, Version 5.0 (5.0.30)

Analysis of Individual Piles and Drilled Shafts
Subjected to Lateral Loading Using the p-y Method

(c) 1985-2007 by Ensoft, Inc.
All Rights Reserved

This program is licensed to:

DJI
Eustis

Path to file locations: U:\sys\WPDATA\Projects\20749\Piles\LPile\
Name of input data file: 12 inch pipe - stratum 5 through 7.lpd
Name of output file: 12 inch pipe - stratum 5 through 7.lpo
Name of plot output file: 12 inch pipe - stratum 5 through 7.lpp
Name of runtime file: 12 inch pipe - stratum 5 through 7.lpr

Time and Date of Analysis

Date: November 9, 2009 Time: 18:29:36

Problem Title

EE20749 - St. Mary Floodgate Structure at Franklin Drainage Canal

Program Options

Units Used in Computations - US Customary Units: Inches, Pounds

Basic Program Options:

Analysis Type 1:

- Computation of Lateral Pile Response Using User-specified Constant EI

Computation Options:

- Only internally-generated p-y curves used in analysis
- Analysis does not use p-y multipliers (individual pile or shaft action only)
- Analysis assumes no shear resistance at pile tip
- Analysis for fixed-length pile or shaft only
- No computation of foundation stiffness matrix elements
- Output pile response for full length of pile
- Analysis assumes no soil movements acting on pile
- Additional p-y curves computed at specified depths

Solution Control Parameters:

- Number of pile increments = 100
- Maximum number of iterations allowed = 100

12 inch pipe - stratum 5 through 7.lpo

- Deflection tolerance for convergence = 1.0000E-05 in
- Maximum allowable deflection = 1.0000E+02 in

Printing Options:

- Values of pile-head deflection, bending moment, shear force, and soil reaction are printed for full length of pile.
- Printing Increment (spacing of output points) = 1

Pile Structural Properties and Geometry

Pile Length = 1690.00 in
Depth of ground surface below top of pile = .00 in
Slope angle of ground surface = .00 deg.

Structural properties of pile defined using 2 points

Point	Depth X in	Pile Diameter in	Moment of Inertia in**4	Pile Area Sq.in	Modulus of Elasticity lbs/Sq.in
1	0.0000	12.00000000	299.2000	18.0600	30000.00000
2	1690.0000	12.00000000	299.2000	18.0600	30000.00000

Soil and Rock Layering Information

The soil profile is modelled using 10 layers

Layer 1 is silt with cohesion and friction
Distance from top of pile to top of layer = .000 in
Distance from top of pile to bottom of layer = 36.000 in
p-y subgrade modulus k for top of soil layer = 55.600 lbs/in**3
p-y subgrade modulus k for bottom of layer = 55.600 lbs/in**3

Layer 2 is soft clay, p-y criteria by Matlock, 1970
Distance from top of pile to top of layer = 36.000 in
Distance from top of pile to bottom of layer = 180.000 in

Layer 3 is silt with cohesion and friction
Distance from top of pile to top of layer = 180.000 in
Distance from top of pile to bottom of layer = 204.000 in
p-y subgrade modulus k for top of soil layer = 55.600 lbs/in**3
p-y subgrade modulus k for bottom of layer = 55.600 lbs/in**3

Layer 4 is soft clay, p-y criteria by Matlock, 1970
Distance from top of pile to top of layer = 204.000 in
Distance from top of pile to bottom of layer = 276.000 in

Layer 5 is soft clay, p-y criteria by Matlock, 1970
Distance from top of pile to top of layer = 276.000 in
Distance from top of pile to bottom of layer = 516.000 in

Layer 6 is stiff clay without free water
Distance from top of pile to top of layer = 516.000 in
Distance from top of pile to bottom of layer = 612.000 in

Layer 7 is stiff clay without free water
Distance from top of pile to top of layer = 612.000 in

12 inch pipe - stratum 5 through 7.1po
 Distance from top of pile to bottom of layer = 828.000 in

Layer 8 is stiff clay without free water
 Distance from top of pile to top of layer = 828.000 in
 Distance from top of pile to bottom of layer = 1212.000 in

Layer 9 is stiff clay without free water
 Distance from top of pile to top of layer = 1212.000 in
 Distance from top of pile to bottom of layer = 1356.000 in

Layer 10 is stiff clay without free water
 Distance from top of pile to top of layer = 1356.000 in
 Distance from top of pile to bottom of layer = 1692.000 in

(Depth of lowest layer extends 2.00 in below pile tip)

 Effective Unit Weight of Soil vs. Depth

Distribution of effective unit weight of soil with depth
 is defined using 20 points

Point No.	Depth X in	Eff. Unit Weight lbs/in**3
1	.00	.03160
2	36.00	.03160
3	36.00	.03330
4	180.00	.03330
5	180.00	.03160
6	204.00	.03160
7	204.00	.03480
8	276.00	.03480
9	276.00	.03250
10	516.00	.03250
11	516.00	.03620
12	612.00	.03620
13	612.00	.03550
14	828.00	.03550
15	828.00	.03110
16	1212.00	.03110
17	1212.00	.03040
18	1356.00	.03040
19	1356.00	.03450
20	1692.00	.03450

 Shear Strength of Soils

Distribution of shear strength parameters with depth
 defined using 20 points

Point No.	Depth X in	Cohesion c lbs/in**2	Angle of Friction Deg.	E50 or k_rm	RQD %
1	.000	1.38890	15.00	.02000	.0
2	36.000	1.38890	15.00	.02000	.0

12 inch pipe - stratum 5 through 7.lpo					
3	36.000	2.20140	.00	.02000	.0
4	180.000	2.20140	.00	.02000	.0
5	180.000	1.38890	15.00	.02000	.0
6	204.000	1.38890	15.00	.02000	.0
7	204.000	3.12500	.00	.02000	.0
8	276.000	3.12500	.00	.02000	.0
9	276.000	4.16670	.00	.01000	.0
10	516.000	7.63890	.00	.00700	.0
11	516.000	7.63890	.00	.00700	.0
12	612.000	7.63890	.00	.00700	.0
13	612.000	9.59030	.00	.00700	.0
14	828.000	9.59030	.00	.00700	.0
15	828.000	7.84720	.00	.00700	.0
16	1212.000	7.84720	.00	.00700	.0
17	1212.000	10.59030	.00	.00700	.0
18	1356.000	10.59030	.00	.00700	.0
19	1356.000	14.34720	.00	.00500	.0
20	1692.000	14.34720	.00	.00500	.0

Notes:

- (1) Cohesion = uniaxial compressive strength for rock materials.
- (2) values of E50 are reported for clay strata.
- (3) Default values will be generated for E50 when input values are 0.
- (4) RQD and k_{rm} are reported only for weak rock strata.

Loading Type

Cyclic loading criteria was used for computation of p-y curves

Number of cycles of loading = 1000.

Pile-head Loading and Pile-head Fixity Conditions

Number of loads specified = 1

Load Case Number 1

Pile-head boundary conditions are Shear and Moment (BC Type 1)

Shear force at pile head = 1000.000 lbs
Bending moment at pile head = 1000.000 in-lbs
Axial load at pile head = 1000.000 lbs

Non-zero moment at pile head for this load case indicates the pile-head may rotate under the applied pile-head loading, but is not a free-head (zero moment) condition.

Output of p-y Curves at Specified Depths

12 inch pipe - stratum 5 through 7.lpo

p-y curves are generated and printed for verification at 9 depths.

Depth No.	Depth Below Pile Head in	Depth Below Ground Surface in
1	288.000	288.000
2	396.000	396.000
3	504.000	504.000
4	528.000	528.000
5	564.000	564.000
6	600.000	600.000
7	624.000	624.000
8	720.000	720.000
9	816.000	816.000

Depth of ground surface below top of pile = .00 in

p-y Curve Computed Using the Soft Clay Criteria for Cyclic Loading Conditions

Soil Layer Number = 5
 Depth below pile head = 288.000 in
 Depth below ground surface = 288.000 in
 Equivalent Depth = 254.385 in
 Pile Diameter = 12.000 in
 Cohesion, c = 4.340 lbs/in**2
 Avg Eff Unit Weight = .03329 lbs/in**3
 E50 parameter = .00985
 Default J parameter = .500
 Y50 = .29550 in
 p-multiplier = 1.00000
 y-multiplier = 1.00000
 Number of cycles of loading = 1000.
 Xr = 121.615 in

y, in	p, lbs/in
0.0000	0.0000
.0023640	46.8753
.0738750	147.6481
.1477500	186.0249
.2216250	212.9454
.2955000	234.3767
.3693750	252.4747
.4432500	268.2944
.5171250	282.4406
.5910000	295.2962
.6648750	307.1204
.7387500	318.0982
.8126250	328.3664
.8865000	337.5025
2.3640	337.5025
4.4325	337.5025
5.9100	337.5025

p-y Curve Computed Using the Soft Clay Criteria for Cyclic Loading Conditions

Soil Layer Number = 5
 Depth below pile head = 396.000 in
 Depth below ground surface = 396.000 in
 Page 5

12 inch pipe - stratum 5 through 7.lpo

Equivalent Depth = 362.385 in
 Pile Diameter = 12.000 in
 Cohesion, c = 5.903 lbs/in**2
 Avg Eff Unit Weight = .03307 lbs/in**3
 E50 parameter = .00850
 Default J parameter = .500
 Y50 = .25500 in
 p-multiplier = 1.00000
 y-multiplier = 1.00000
 Number of cycles of loading = 1000.
 Xr = 126.932 in

y, in	p, lbs/in
0.0000	0.0000
.0020400	63.7502
.0637500	200.8007
.1275000	252.9930
.1912500	289.6047
.2550000	318.7512
.3187500	343.3643
.3825000	364.8790
.4462500	384.1179
.5100000	401.6013
.5737500	417.6822
.6375000	432.6119
.7012500	446.5767
.7650000	459.7188
2.0400	459.0017
3.8250	459.0017
5.1000	459.0017

p-y Curve Computed Using the Soft Clay Criteria for Cyclic Loading Conditions

Soil Layer Number = 5
 Depth below pile head = 504.000 in
 Depth below ground surface = 504.000 in
 Equivalent Depth = 470.385 in
 Pile Diameter = 12.000 in
 Cohesion, c = 7.465 lbs/in**2
 Avg Eff Unit Weight = .03295 lbs/in**3
 E50 parameter = .00715
 Default J parameter = .500
 Y50 = .21450 in
 p-multiplier = 1.00000
 y-multiplier = 1.00000
 Number of cycles of loading = 1000.
 Xr = 130.207 in

y, in	p, lbs/in
0.0000	0.0000
.0017160	80.6251
.0536250	253.9532
.1072500	319.9610
.1608750	366.2640
.2145000	403.1257
.2681250	434.2540
.3217500	461.4637
.3753750	485.7951
.4290000	507.9065
.4826250	528.2441

12 inch pipe - stratum 5 through 7.lpo

.5362500	547.1257
.5898750	564.7870
.6435000	581.4078
1.7160	580.5010
3.2175	580.5010
4.2900	580.5010

p-y Curve Computed Using Cyclic Criteria for Stiff Clay without Free Water

Soil Layer Number	=	6
Depth below pile head	=	528.000 in
Depth below ground surface	=	528.000 in
Equivalent Depth	=	263.287 in
Diameter	=	12.000 in
Undrained cohesion, c	=	7.63890 lbs/in**2
Average Eff. Unit Weight	=	.03301 lbs/in**3
Epsilon-50	=	.00700
Pct	=	1384.917 lbs/in
Pcd	=	825.001 lbs/in
Pu	=	825.001 lbs/in
y50	=	.210 in
p-multiplier	=	1.00000
y-multiplier	=	1.00000
Number of cycles of loading	=	1000.

y, in	p, lbs/in
0.0000	0.0000
3.3600E-05	35.8645
.0001680	53.6300
.0003360	63.7771
.0016800	95.3691
.0033600	113.4136
.0168000	169.5929
.0336000	201.6810
.0840000	253.6005
.1680000	301.5835
.2520000	333.7570
.3360000	358.6452
.8400000	450.9725
1.6800	536.2997
3.3600	637.7714
7.5600	781.1073
11.7600	825.0012

p-y Curve Computed Using Cyclic Criteria for Stiff Clay without Free Water

Soil Layer Number	=	6
Depth below pile head	=	564.000 in
Depth below ground surface	=	564.000 in
Equivalent Depth	=	299.287 in
Diameter	=	12.000 in
Undrained cohesion, c	=	7.63890 lbs/in**2
Average Eff. Unit Weight	=	.03322 lbs/in**3
Epsilon-50	=	.00700
Pct	=	1537.409 lbs/in
Pcd	=	825.001 lbs/in
Pu	=	825.001 lbs/in

Page 7

12 inch pipe - stratum 5 through 7.lpo

y50 = .210 in
 p-multiplier = 1.00000
 y-multiplier = 1.00000
 Number of cycles of loading = 1000.

y, in	p, lbs/in
0.0000	0.0000
3.3600E-05	35.8645
.0001680	53.6300
.0003360	63.7771
.0016800	95.3691
.0033600	113.4136
.0168000	169.5929
.0336000	201.6810
.0840000	253.6005
.1680000	301.5835
.2520000	333.7570
.3360000	358.6452
.8400000	450.9725
1.6800	536.2997
3.3600	637.7714
7.5600	781.1073
11.7600	825.0012

p-y Curve Computed Using Cyclic Criteria for Stiff Clay without Free Water

Soil Layer Number = 6
 Depth below pile head = 600.000 in
 Depth below ground surface = 600.000 in
 Equivalent Depth = 335.287 in
 Diameter = 12.000 in
 Undrained cohesion, c = 7.63890 lbs/in**2
 Average Eff. Unit Weight = .03340 lbs/in**3
 Epsilon-50 = .00700
 Pct = 1689.979 lbs/in
 Pcd = 825.001 lbs/in
 Pu = 825.001 lbs/in
 y50 = .210 in
 p-multiplier = 1.00000
 y-multiplier = 1.00000
 Number of cycles of loading = 1000.

y, in	p, lbs/in
0.0000	0.0000
3.3600E-05	35.8645
.0001680	53.6300
.0003360	63.7771
.0016800	95.3691
.0033600	113.4136
.0168000	169.5929
.0336000	201.6810
.0840000	253.6005
.1680000	301.5835
.2520000	333.7570
.3360000	358.6452
.8400000	450.9725
1.6800	536.2997
3.3600	637.7714
7.5600	781.1073
11.7600	825.0012

12 inch pipe - stratum 5 through 7.lpo

p-y Curve Computed Using Cyclic Criteria for Stiff Clay without Free Water

Soil Layer Number = 7
 Depth below pile head = 624.000 in
 Depth below ground surface = 624.000 in
 Equivalent Depth = 291.975 in
 Diameter = 12.000 in
 Undrained cohesion, c = 9.59030 lbs/in**2
 Average Eff. Unit Weight = .03349 lbs/in**3
 Epsilon-50 = .00700
 Pct = 1862.654 lbs/in
 Pcd = 1035.752 lbs/in
 Pu = 1035.752 lbs/in
 y50 = .210 in
 p-multiplier = 1.00000
 y-multiplier = 1.00000
 Number of cycles of loading = 1000.

y, in	p, lbs/in
0.0000	0.0000
3.3600E-05	45.0263
.0001680	67.3300
.0003360	80.0694
.0016800	119.7316
.0033600	142.3857
.0168000	212.9163
.0336000	253.2016
.0840000	318.3842
.1680000	378.6247
.2520000	419.0171
.3360000	450.2632
.8400000	566.1760
1.6800	673.3005
3.3600	800.6937
7.5600	980.6456
11.7600	1035.7524

p-y Curve Computed Using Cyclic Criteria for Stiff Clay without Free Water

Soil Layer Number = 7
 Depth below pile head = 720.000 in
 Depth below ground surface = 720.000 in
 Equivalent Depth = 387.975 in
 Diameter = 12.000 in
 Undrained cohesion, c = 9.59030 lbs/in**2
 Average Eff. Unit Weight = .03376 lbs/in**3
 Epsilon-50 = .00700
 Pct = 2362.817 lbs/in
 Pcd = 1035.752 lbs/in
 Pu = 1035.752 lbs/in
 y50 = .210 in
 p-multiplier = 1.00000
 y-multiplier = 1.00000
 Number of cycles of loading = 1000.

y, in p, lbs/in

12 inch pipe - stratum 5 through 7.1po

y, in	p, lbs/in
0.0000	0.0000
3.3600E-05	45.0263
.0001680	67.3300
.0003360	80.0694
.0016800	119.7316
.0033600	142.3857
.0168000	212.9163
.0336000	253.2016
.0840000	318.3842
.1680000	378.6247
.2520000	419.0171
.3360000	450.2632
.8400000	566.1760
1.6800	673.3005
3.3600	800.6937
7.5600	980.6456
11.7600	1035.7524

p-y Curve Computed Using Cyclic Criteria for Stiff Clay without Free Water

Soil Layer Number = 7
 Depth below pile head = 816.000 in
 Depth below ground surface = 816.000 in
 Equivalent Depth = 483.975 in
 Diameter = 12.000 in
 Undrained cohesion, c = 9.59030 lbs/in**2
 Average Eff. Unit Weight = .03396 lbs/in**3
 Epsilon-50 = .00700
 Pct = 2863.231 lbs/in
 Pcd = 1035.752 lbs/in
 Pu = 1035.752 lbs/in
 y50 = .210 in
 p-multiplier = 1.00000
 y-multiplier = 1.00000
 Number of cycles of loading = 1000.

y, in	p, lbs/in
0.0000	0.0000
3.3600E-05	45.0263
.0001680	67.3300
.0003360	80.0694
.0016800	119.7316
.0033600	142.3857
.0168000	212.9163
.0336000	253.2016
.0840000	318.3842
.1680000	378.6247
.2520000	419.0171
.3360000	450.2632
.8400000	566.1760
1.6800	673.3005
3.3600	800.6937
7.5600	980.6456
11.7600	1035.7524

12 inch pipe - stratum 5 through 7.lpo
 Computed Values of Load Distribution and Deflection
 for Lateral Loading for Load Case Number 1

Pile-head boundary conditions are Shear and Moment (BC Type 1)
 Specified shear force at pile head = 1000.000 lbs
 Specified moment at pile head = 1000.000 in-lbs
 Specified axial load at pile head = 1000.000 lbs

Non-zero moment for this load case indicates the pile-head may rotate under the applied pile-head loading, but is not a free-head (zero moment) condition.

Depth Es*h X F/L in lbs/in	Deflect. y in	Moment M lbs-in	Shear V lbs	Slope S Rad.	Total Stress lbs/in**2	Soil Res. p lbs/in
0.000	.842040	1000.0000	1000.0000	-.0439100	75.4245	0.0000
0.0000						
16.900	.115870	18626.1695	79.9959	-.0254339	428.8904	-108.8762
15879.9160						
33.800	-.017628	4563.5284	-560.0804	-.0036032	146.8856	33.1276
31759.8320						
50.700	-.005917	-182.7611	-139.9365	.0005209	59.0360	16.5936
47390.5810						
67.600	-2.25E-05	-183.9316	5.5251	.0001757	59.0595	.6207744
466786.						
84.500	1.99E-05	-1.9501	5.4604	6.7410E-07	55.4101	-.6284370
532561.						
101.400	3.09E-07	.6055504	.0574929	-5.9165E-07	55.3831	-.0109547
598337.						
118.300	-5.55E-08	.0131604	-.0179734	-9.2006E-09	55.3712	.0020238
616768.						
135.200	-1.57E-09	-.0016397	-.0003894	1.6449E-09	55.3710	5.7174E-05
616768.						
152.100	1.46E-10	-5.8207E-05	4.8681E-05	4.6537E-11	55.3710	-5.3254E-06
616768.						
169.000	6.34E-12	4.1359E-06	1.7266E-06	-4.3660E-12	55.3710	-2.3126E-07
616768.						
185.900	-1.65E-12	2.9784E-07	-1.2379E-07	-1.9211E-13	55.3710	1.2282E-08
125909.						
202.800	-1.57E-13	-4.1897E-08	-8.9123E-09	4.8835E-14	55.3710	1.3139E-09
141789.						
219.700	2.16E-15	-5.0463E-09	1.2456E-09	4.6434E-15	55.3710	-1.1176E-10
875533.						
236.600	3.46E-16	4.5969E-11	1.4956E-10	-6.3871E-17	55.3710	-1.7947E-11
875533.						
253.500	-1.65E-18	1.0967E-11	-1.3704E-12	-1.0271E-17	55.3710	8.5353E-14
875533.						
270.400	-7.40E-19	-5.2916E-15	-3.2511E-13	4.8698E-20	55.3710	3.8355E-14
875533.						
287.300	-1.55E-21	-2.3144E-14	1.7551E-16	2.1928E-20	55.3710	1.4061E-16
1535789.						
304.200	8.30E-22	-1.0063E-16	6.8554E-16	4.5930E-23	55.3710	-8.0250E-17
1634263.						
321.100	5.15E-24	2.5731E-17	2.9588E-18	-2.4577E-23	55.3710	-5.2889E-19
1734362.						
338.000	-8.15E-25	2.1294E-19	-7.6217E-19	-1.5271E-25	55.3710	8.8537E-20
1836160.						
354.900	0.000	-2.5085E-20	-6.2845E-21	0.0000	55.3710	9.1738E-22

12 inch pipe - stratum 5 through 7.lpo

1939740.						
371.800	0.000	-2.9542E-22	7.4305E-22	0.0000	55.3710	-8.5719E-23
2045190.						
388.700	0.000	2.1660E-23	8.7289E-24	0.0000	55.3710	-1.1825E-24
2152606.						
405.600	0.000	3.2601E-25	-6.4160E-25	0.0000	55.3710	0.0000
2262088.						
422.500	0.000	0.0000	0.0000	0.0000	55.3710	0.0000
2373749.						
439.400	0.000	0.0000	0.0000	0.0000	55.3710	0.0000
2487708.						
456.300	0.000	0.0000	0.0000	0.0000	55.3710	0.0000
2604096.						
473.200	0.000	0.0000	0.0000	0.0000	55.3710	0.0000
2723054.						
490.100	0.000	0.0000	0.0000	0.0000	55.3710	0.0000
2844737.						
507.000	0.000	0.0000	0.0000	0.0000	55.3710	0.0000
2969314.						
523.900	0.000	0.0000	0.0000	0.0000	55.3710	0.0000
5340698.						
540.800	0.000	0.0000	0.0000	0.0000	55.3710	0.0000
5340698.						
557.700	0.000	0.0000	0.0000	0.0000	55.3710	0.0000
5340698.						
574.600	0.000	0.0000	0.0000	0.0000	55.3710	0.0000
5340698.						
591.500	0.000	0.0000	0.0000	0.0000	55.3710	0.0000
5340698.						
608.400	0.000	0.0000	0.0000	0.0000	55.3710	0.0000
5340698.						
625.300	0.000	0.0000	0.0000	0.0000	55.3710	0.0000
6705010.						
642.200	0.000	0.0000	0.0000	0.0000	55.3710	0.0000
6705010.						
659.100	0.000	0.0000	0.0000	0.0000	55.3710	0.0000
6705010.						
676.000	0.000	0.0000	0.0000	0.0000	55.3710	0.0000
6705010.						
692.900	0.000	0.0000	0.0000	0.0000	55.3710	0.0000
6705010.						
709.800	0.000	0.0000	0.0000	0.0000	55.3710	0.0000
6705010.						
726.700	0.000	0.0000	0.0000	0.0000	55.3710	0.0000
6705010.						
743.600	0.000	0.0000	0.0000	0.0000	55.3710	0.0000
6705010.						
760.500	0.000	0.0000	0.0000	0.0000	55.3710	0.0000
6705010.						
777.400	0.000	0.0000	0.0000	0.0000	55.3710	0.0000
6705010.						
794.300	0.000	0.0000	0.0000	0.0000	55.3710	0.0000
6705010.						
811.200	0.000	0.0000	0.0000	0.0000	55.3710	0.0000
6705010.						
828.100	0.000	0.0000	0.0000	0.0000	55.3710	0.0000
5486330.						
845.000	0.000	0.0000	0.0000	0.0000	55.3710	0.0000
5486330.						
861.900	0.000	0.0000	0.0000	0.0000	55.3710	0.0000
5486330.						
878.800	0.000	0.0000	0.0000	0.0000	55.3710	0.0000
5486330.						

12 inch pipe - stratum 5 through 7.1po						
895.700	0.000	0.0000	0.0000	0.0000	55.3710	0.0000
5486330.						
912.600	0.000	0.0000	0.0000	0.0000	55.3710	0.0000
5486330.						
929.500	0.000	0.0000	0.0000	0.0000	55.3710	0.0000
5486330.						
946.400	0.000	0.0000	0.0000	0.0000	55.3710	0.0000
5486330.						
963.300	0.000	0.0000	0.0000	0.0000	55.3710	0.0000
5486330.						
980.200	0.000	0.0000	0.0000	0.0000	55.3710	0.0000
5486330.						
997.100	0.000	0.0000	0.0000	0.0000	55.3710	0.0000
5486330.						
1014.	0.000	0.0000	0.0000	0.0000	55.3710	0.0000
5486330.						
1031.	0.000	0.0000	0.0000	0.0000	55.3710	0.0000
5486330.						
1048.	0.000	0.0000	0.0000	0.0000	55.3710	0.0000
5486330.						
1065.	0.000	0.0000	0.0000	0.0000	55.3710	0.0000
5486330.						
1082.	0.000	0.0000	0.0000	0.0000	55.3710	0.0000
5486330.						
1099.	0.000	0.0000	0.0000	0.0000	55.3710	0.0000
5486330.						
1115.	0.000	0.0000	0.0000	0.0000	55.3710	0.0000
5486330.						
1132.	0.000	0.0000	0.0000	0.0000	55.3710	0.0000
5486330.						
1149.	0.000	0.0000	0.0000	0.0000	55.3710	0.0000
5486330.						
1166.	0.000	0.0000	0.0000	0.0000	55.3710	0.0000
5486330.						
1183.	0.000	0.0000	0.0000	0.0000	55.3710	0.0000
5486330.						
1200.	0.000	0.0000	0.0000	0.0000	55.3710	0.0000
5486330.						
1217.	0.000	0.0000	0.0000	0.0000	55.3710	0.0000
7404154.						
1234.	0.000	0.0000	0.0000	0.0000	55.3710	0.0000
7404154.						
1251.	0.000	0.0000	0.0000	0.0000	55.3710	0.0000
7404154.						
1268.	0.000	0.0000	0.0000	0.0000	55.3710	0.0000
7404154.						
1284.	0.000	0.0000	0.0000	0.0000	55.3710	0.0000
7404154.						
1301.	0.000	0.0000	0.0000	0.0000	55.3710	0.0000
7404154.						
1318.	0.000	0.0000	0.0000	0.0000	55.3710	0.0000
7404154.						
1335.	0.000	0.0000	0.0000	0.0000	55.3710	0.0000
7404154.						
1352.	0.000	0.0000	0.0000	0.0000	55.3710	0.0000
7404154.						
1369.	0.000	0.0000	0.0000	0.0000	55.3710	0.0000
1.0911E+07						
1386.	0.000	0.0000	0.0000	0.0000	55.3710	0.0000
1.0911E+07						
1403.	0.000	0.0000	0.0000	0.0000	55.3710	0.0000
1.0911E+07						
1420.	0.000	0.0000	0.0000	0.0000	55.3710	0.0000

12 inch pipe - stratum 5 through 7.lpo						
1.0911E+07						
1436.	0.000	0.0000	0.0000	0.0000	55.3710	0.0000
1.0911E+07						
1453.	0.000	0.0000	0.0000	0.0000	55.3710	0.0000
1.0911E+07						
1470.	0.000	0.0000	0.0000	0.0000	55.3710	0.0000
1.0911E+07						
1487.	0.000	0.0000	0.0000	0.0000	55.3710	0.0000
1.0911E+07						
1504.	0.000	0.0000	0.0000	0.0000	55.3710	0.0000
1.0911E+07						
1521.	0.000	0.0000	0.0000	0.0000	55.3710	0.0000
1.0911E+07						
1538.	0.000	0.0000	0.0000	0.0000	55.3710	0.0000
1.0911E+07						
1555.	0.000	0.0000	0.0000	0.0000	55.3710	0.0000
1.0911E+07						
1572.	0.000	0.0000	0.0000	0.0000	55.3710	0.0000
1.0911E+07						
1589.	0.000	0.0000	0.0000	0.0000	55.3710	0.0000
1.0911E+07						
1605.	0.000	0.0000	0.0000	0.0000	55.3710	0.0000
1.0911E+07						
1622.	0.000	0.0000	0.0000	0.0000	55.3710	0.0000
1.0911E+07						
1639.	0.000	0.0000	0.0000	0.0000	55.3710	0.0000
1.0911E+07						
1656.	0.000	0.0000	0.0000	0.0000	55.3710	0.0000
1.0911E+07						
1673.	0.000	0.0000	0.0000	0.0000	55.3710	0.0000
1.0911E+07						
1690.	0.000	0.0000	0.0000	0.0000	55.3710	0.0000
5455523.						

Output Verification:

Computed forces and moments are within specified convergence limits.

Output Summary for Load Case No. 1:

Pile-head deflection = .84203969 in
 Computed slope at pile head = -.04391001
 Maximum bending moment = 18626.16954 lbs-in
 Maximum shear force = 1000.00000 lbs
 Depth of maximum bending moment = 16.90000000 in
 Depth of maximum shear force = 0.00000 in
 Number of iterations = 14
 Number of zero deflection points = 49

 Summary of Pile Response(s)

Definition of Symbols for Pile-Head Loading Conditions:

Type 1 = Shear and Moment, y = pile-head displacement in
 Type 2 = Shear and Slope, M = Pile-head Moment lbs-in
 Type 3 = Shear and Rot. Stiffness, V = Pile-head Shear Force lbs
 Page 14

12 inch pipe - stratum 5 through 7.lpo

Type 4 = Deflection and Moment,
Type 5 = Deflection and Slope,

S = Pile-head Slope, radians
R = Rot. Stiffness of Pile-head in-lbs/rad

Load Type	Pile-Head Condition 1	Pile-Head Condition 2	Axial Load lbs	Pile-Head Deflection in	Maximum Moment in-lbs	Maximum Shear lbs
1	V= 1000.000	M= 1000.000	1000.0000	.8420397	18626.1695	1000.0000

The analysis ended normally.

12 inch pipe - stratum 8 through 10.lpo

LPILE Plus for windows, Version 5.0 (5.0.30)

Analysis of Individual Piles and Drilled Shafts
Subjected to Lateral Loading Using the p-y Method

(c) 1985-2007 by Ensoft, Inc.
All Rights Reserved

This program is licensed to:

DJI
Eustis

Path to file locations: U:\sys\WPDATA\Projects\20749\Piles\LPile\
Name of input data file: 12 inch pipe - stratum 8 through 10.lpd
Name of output file: 12 inch pipe - stratum 8 through 10.lpo
Name of plot output file: 12 inch pipe - stratum 8 through 10.lpp
Name of runtime file: 12 inch pipe - stratum 8 through 10.lpr

Time and Date of Analysis

Date: November 9, 2009 Time: 18:31:29

Problem Title

EE20749 - St. Mary Floodgate Structure at Franklin Drainage Canal

Program Options

Units Used in Computations - US Customary Units: Inches, Pounds

Basic Program Options:

Analysis Type 1:

- Computation of Lateral Pile Response Using User-specified Constant EI

Computation Options:

- Only internally-generated p-y curves used in analysis
- Analysis does not use p-y multipliers (individual pile or shaft action only)
- Analysis assumes no shear resistance at pile tip
- Analysis for fixed-length pile or shaft only
- No computation of foundation stiffness matrix elements
- Output pile response for full length of pile
- Analysis assumes no soil movements acting on pile
- Additional p-y curves computed at specified depths

Solution Control Parameters:

- Number of pile increments = 100
- Maximum number of iterations allowed = 100

12 inch pipe - stratum 8 through 10.lpo

- Deflection tolerance for convergence = 1.0000E-05 in
- Maximum allowable deflection = 1.0000E+02 in

Printing Options:

- Values of pile-head deflection, bending moment, shear force, and soil reaction are printed for full length of pile.
- Printing Increment (spacing of output points) = 1

Pile Structural Properties and Geometry

Pile Length = 1690.00 in
Depth of ground surface below top of pile = .00 in
Slope angle of ground surface = .00 deg.

Structural properties of pile defined using 2 points

Point	Depth X in	Pile Diameter in	Moment of Inertia in**4	Pile Area Sq.in	Modulus of Elasticity lbs/Sq.in
1	0.0000	12.00000000	299.2000	18.0600	30000.00000
2	1690.0000	12.00000000	299.2000	18.0600	30000.00000

Soil and Rock Layering Information

The soil profile is modelled using 10 layers

Layer 1 is silt with cohesion and friction
Distance from top of pile to top of layer = .000 in
Distance from top of pile to bottom of layer = 36.000 in
p-y subgrade modulus k for top of soil layer = 55.600 lbs/in**3
p-y subgrade modulus k for bottom of layer = 55.600 lbs/in**3

Layer 2 is soft clay, p-y criteria by Matlock, 1970
Distance from top of pile to top of layer = 36.000 in
Distance from top of pile to bottom of layer = 180.000 in

Layer 3 is silt with cohesion and friction
Distance from top of pile to top of layer = 180.000 in
Distance from top of pile to bottom of layer = 204.000 in
p-y subgrade modulus k for top of soil layer = 55.600 lbs/in**3
p-y subgrade modulus k for bottom of layer = 55.600 lbs/in**3

Layer 4 is soft clay, p-y criteria by Matlock, 1970
Distance from top of pile to top of layer = 204.000 in
Distance from top of pile to bottom of layer = 276.000 in

Layer 5 is soft clay, p-y criteria by Matlock, 1970
Distance from top of pile to top of layer = 276.000 in
Distance from top of pile to bottom of layer = 516.000 in

Layer 6 is stiff clay without free water
Distance from top of pile to top of layer = 516.000 in
Distance from top of pile to bottom of layer = 612.000 in

Layer 7 is stiff clay without free water
Distance from top of pile to top of layer = 612.000 in

12 inch pipe - stratum 8 through 10.1po
 Distance from top of pile to bottom of layer = 828.000 in
 Layer 8 is stiff clay without free water
 Distance from top of pile to top of layer = 828.000 in
 Distance from top of pile to bottom of layer = 1212.000 in
 Layer 9 is stiff clay without free water
 Distance from top of pile to top of layer = 1212.000 in
 Distance from top of pile to bottom of layer = 1356.000 in
 Layer 10 is stiff clay without free water
 Distance from top of pile to top of layer = 1356.000 in
 Distance from top of pile to bottom of layer = 1692.000 in

(Depth of lowest layer extends 2.00 in below pile tip)

 Effective Unit Weight of Soil vs. Depth

Distribution of effective unit weight of soil with depth
 is defined using 20 points

Point No.	Depth X in	Eff. Unit Weight lbs/in**3
1	.00	.03160
2	36.00	.03160
3	36.00	.03330
4	180.00	.03330
5	180.00	.03160
6	204.00	.03160
7	204.00	.03480
8	276.00	.03480
9	276.00	.03250
10	516.00	.03250
11	516.00	.03620
12	612.00	.03620
13	612.00	.03550
14	828.00	.03550
15	828.00	.03110
16	1212.00	.03110
17	1212.00	.03040
18	1356.00	.03040
19	1356.00	.03450
20	1692.00	.03450

 Shear Strength of Soils

Distribution of shear strength parameters with depth
 defined using 20 points

Point No.	Depth X in	Cohesion c lbs/in**2	Angle of Friction Deg.	E50 or k _{rm}	RQD %
1	.000	1.38890	15.00	.02000	.0
2	36.000	1.38890	15.00	.02000	.0

12 inch pipe - stratum 8 through 10.1po						
3	36.000	2.20140	.00	.02000	.0	
4	180.000	2.20140	.00	.02000	.0	
5	180.000	1.38890	15.00	.02000	.0	
6	204.000	1.38890	15.00	.02000	.0	
7	204.000	3.12500	.00	.02000	.0	
8	276.000	3.12500	.00	.02000	.0	
9	276.000	4.16670	.00	.01000	.0	
10	516.000	7.63890	.00	.00700	.0	
11	516.000	7.63890	.00	.00700	.0	
12	612.000	7.63890	.00	.00700	.0	
13	612.000	9.59030	.00	.00700	.0	
14	828.000	9.59030	.00	.00700	.0	
15	828.000	7.84720	.00	.00700	.0	
16	1212.000	7.84720	.00	.00700	.0	
17	1212.000	10.59030	.00	.00700	.0	
18	1356.000	10.59030	.00	.00700	.0	
19	1356.000	14.34720	.00	.00500	.0	
20	1692.000	14.34720	.00	.00500	.0	

Notes:

- (1) Cohesion = uniaxial compressive strength for rock materials.
- (2) Values of E50 are reported for clay strata.
- (3) Default values will be generated for E50 when input values are 0.
- (4) RQD and k_{rm} are reported only for weak rock strata.

Loading Type

Cyclic loading criteria was used for computation of p-y curves

Number of cycles of loading = 1000.

Pile-head Loading and Pile-head Fixity Conditions

Number of loads specified = 1

Load Case Number 1

Pile-head boundary conditions are Shear and Moment (BC Type 1)

Shear force at pile head = 1000.000 lbs
 Bending moment at pile head = 1000.000 in-lbs
 Axial load at pile head = 1000.000 lbs

Non-zero moment at pile head for this load case indicates the pile-head may rotate under the applied pile-head loading, but is not a free-head (zero moment) condition.

Output of p-y Curves at Specified Depths

12 inch pipe - stratum 8 through 10.1po

p-y curves are generated and printed for verification at 8 depths.

Depth No.	Depth Below Pile Head in	Depth Below Ground Surface in
1	840.000	840.000
2	1020.000	1020.000
3	1200.000	1200.000
4	1224.000	1224.000
5	1284.000	1284.000
6	1344.000	1344.000
7	1524.000	1524.000
8	1690.000	1690.000

Depth of ground surface below top of pile = .00 in

p-y Curve Computed Using Cyclic Criteria for Stiff Clay without Free Water

Soil Layer Number = 8
 Depth below pile head = 840.000 in
 Depth below ground surface = 840.000 in
 Equivalent Depth = 591.247 in
 Diameter = 12.000 in
 Undrained cohesion, c = 7.84720 lbs/in**2
 Average Eff. Unit Weight = .03394 lbs/in**3
 Epsilon-50 = .00700
 Pct = 2843.148 lbs/in
 Pcd = 847.498 lbs/in
 Pu = 847.498 lbs/in
 y50 = .210 in
 p-multiplier = 1.00000
 y-multiplier = 1.00000
 Number of cycles of loading = 1000.

y, in	p, lbs/in
0.0000	0.0000
3.3600E-05	36.8425
.0001680	55.0924
.0003360	65.5162
.0016800	97.9696
.0033600	116.5062
.0168000	174.2174
.0336000	207.1805
.0840000	260.5157
.1680000	309.8072
.2520000	342.8580
.3360000	368.4249
.8400000	463.2698
1.6800	550.9237
3.3600	655.1624
7.5600	802.4068
11.7600	847.4976

p-y Curve Computed Using Cyclic Criteria for Stiff Clay without Free Water

Soil Layer Number = 8
 Depth below pile head = 1020.000 in
 Depth below ground surface = 1020.000 in

12 inch pipe - stratum 8 through 10.1po

Equivalent Depth = 771.247 in
 Diameter = 12.000 in
 Undrained cohesion, c = 7.84720 lbs/in**2
 Average Eff. Unit Weight = .03344 lbs/in**3
 Epsilon-50 = .00700
 Pct = 3618.070 lbs/in
 Pcd = 847.498 lbs/in
 Pu = 847.498 lbs/in
 y50 = .210 in
 p-multiplier = 1.00000
 y-multiplier = 1.00000
 Number of cycles of loading = 1000.

y, in	p, lbs/in
0.0000	0.0000
3.3600E-05	36.8425
.0001680	55.0924
.0003360	65.5162
.0016800	97.9696
.0033600	116.5062
.0168000	174.2174
.0336000	207.1805
.0840000	260.5157
.1680000	309.8072
.2520000	342.8580
.3360000	368.4249
.8400000	463.2698
1.6800	550.9237
3.3600	655.1624
7.5600	802.4068
11.7600	847.4976

p-y Curve Computed Using Cyclic Criteria for Stiff Clay without Free Water

Soil Layer Number = 8
 Depth below pile head = 1200.000 in
 Depth below ground surface = 1200.000 in
 Equivalent Depth = 951.247 in
 Diameter = 12.000 in
 Undrained cohesion, c = 7.84720 lbs/in**2
 Average Eff. Unit Weight = .03309 lbs/in**3
 Epsilon-50 = .00700
 Pct = 4392.543 lbs/in
 Pcd = 847.498 lbs/in
 Pu = 847.498 lbs/in
 y50 = .210 in
 p-multiplier = 1.00000
 y-multiplier = 1.00000
 Number of cycles of loading = 1000.

y, in	p, lbs/in
0.0000	0.0000
3.3600E-05	36.8425
.0001680	55.0924
.0003360	65.5162
.0016800	97.9696
.0033600	116.5062
.0168000	174.2174
.0336000	207.1805
.0840000	260.5157

	12 inch pipe - stratum 8 through 10.1po
.1680000	309.8072
.2520000	342.8580
.3360000	368.4249
.8400000	463.2698
1.6800	550.9237
3.3600	655.1624
7.5600	802.4068
11.7600	847.4976

p-y Curve Computed Using Cyclic Criteria for Stiff Clay without Free Water

Soil Layer Number = 9
 Depth below pile head = 1224.000 in
 Depth below ground surface = 1224.000 in
 Equivalent Depth = 738.109 in
 Diameter = 12.000 in
 Undrained cohesion, c = 10.59030 lbs/in**2
 Average Eff. Unit Weight = .03305 lbs/in**3
 Epsilon-50 = .00700
 Pct = 4582.336 lbs/in
 Pcd = 1143.752 lbs/in
 Pu = 1143.752 lbs/in
 y50 = .210 in
 p-multiplier = 1.00000
 y-multiplier = 1.00000
 Number of cycles of loading = 1000.

y, in	p, lbs/in
0.0000	0.0000
3.3600E-05	49.7213
.0001680	74.3507
.0003360	88.4184
.0016800	132.2163
.0033600	157.2326
.0168000	235.1175
.0336000	279.6034
.0840000	351.5827
.1680000	418.1047
.2520000	462.7089
.3360000	497.2130
.8400000	625.2123
1.6800	743.5069
3.3600	884.1837
7.5600	1082.8995
11.7600	1143.7524

p-y Curve Computed Using Cyclic Criteria for Stiff Clay without Free Water

Soil Layer Number = 9
 Depth below pile head = 1284.000 in
 Depth below ground surface = 1284.000 in
 Equivalent Depth = 798.109 in
 Diameter = 12.000 in
 Undrained cohesion, c = 10.59030 lbs/in**2
 Average Eff. Unit Weight = .03292 lbs/in**3
 Epsilon-50 = .00700
 Pct = 4922.654 lbs/in

12 inch pipe - stratum 8 through 10.7po

Pcd = 1143.752 lbs/in
 Pu = 1143.752 lbs/in
 y50 = .210 in
 p-multiplier = 1.00000
 y-multiplier = 1.00000
 Number of cycles of loading = 1000.

y, in	p, lbs/in
0.0000	0.0000
3.3600E-05	49.7213
.0001680	74.3507
.0003360	88.4184
.0016800	132.2163
.0033600	157.2326
.0168000	235.1175
.0336000	279.6034
.0840000	351.5827
.1680000	418.1047
.2520000	462.7089
.3360000	497.2130
.8400000	625.2123
1.6800	743.5069
3.3600	884.1837
7.5600	1082.8995
11.7600	1143.7524

p-y Curve Computed Using Cyclic Criteria for Stiff Clay without Free Water

Soil Layer Number = 9
 Depth below pile head = 1344.000 in
 Depth below ground surface = 1344.000 in
 Equivalent Depth = 858.109 in
 Diameter = 12.000 in
 Undrained cohesion, c = 10.59030 lbs/in**2
 Average Eff. Unit weight = .03281 lbs/in**3
 Epsilon-50 = .00700
 Pct = 5262.908 lbs/in
 Pcd = 1143.752 lbs/in
 Pu = 1143.752 lbs/in
 y50 = .210 in
 p-multiplier = 1.00000
 y-multiplier = 1.00000
 Number of cycles of loading = 1000.

y, in	p, lbs/in
0.0000	0.0000
3.3600E-05	49.7213
.0001680	74.3507
.0003360	88.4184
.0016800	132.2163
.0033600	157.2326
.0168000	235.1175
.0336000	279.6034
.0840000	351.5827
.1680000	418.1047
.2520000	462.7089
.3360000	497.2130
.8400000	625.2123
1.6800	743.5069
3.3600	884.1837

	12 inch pipe - stratum 8 through 10.1po
7.5600	1082.8995
11.7600	1143.7524

p-y Curve Computed Using Cyclic Criteria for stiff Clay without Free Water

Soil Layer Number	=	10
Depth below pile head	=	1524.000 in
Depth below ground surface	=	1524.000 in
Equivalent Depth	=	819.264 in
Diameter	=	12.000 in
Undrained cohesion, c	=	14.34720 lbs/in**2
Average Eff. Unit Weight	=	.03298 lbs/in**3
Epsilon-50	=	.00500
Pct	=	6717.768 lbs/in
Pcd	=	1549.498 lbs/in
Pu	=	1549.498 lbs/in
y50	=	.150 in
p-multiplier	=	1.00000
y-multiplier	=	1.00000
Number of cycles of loading	=	1000.

y, in	p, lbs/in
0.0000	0.0000
2.4000E-05	67.3599
.0001200	100.7265
.0002400	119.7847
.0012000	179.1199
.0024000	213.0107
.0120000	318.5253
.0240000	378.7925
.0600000	476.3064
.1200000	566.4269
.1800000	626.8545
.2400000	673.5989
.6000000	847.0058
1.2000	1007.2654
2.4000	1197.8471
5.4000	1467.0571
8.4000	1549.4976

p-y Curve Computed Using Cyclic Criteria for stiff Clay without Free Water

Soil Layer Number	=	10
Depth below pile head	=	1690.000 in
Depth below ground surface	=	1690.000 in
Equivalent Depth	=	985.264 in
Diameter	=	12.000 in
Undrained cohesion, c	=	14.34720 lbs/in**2
Average Eff. Unit Weight	=	.03313 lbs/in**3
Epsilon-50	=	.00500
Pct	=	7976.044 lbs/in
Pcd	=	1549.498 lbs/in
Pu	=	1549.498 lbs/in
y50	=	.150 in
p-multiplier	=	1.00000
y-multiplier	=	1.00000
Number of cycles of loading	=	1000.

12 inch pipe - stratum 8 through 10.1po

y, in	p, lbs/in
0.0000	0.0000
2.4000E-05	67.3599
.0001200	100.7265
.0002400	119.7847
.0012000	179.1199
.0024000	213.0107
.0120000	318.5253
.0240000	378.7925
.0600000	476.3064
.1200000	566.4269
.1800000	626.8545
.2400000	673.5989
.6000000	847.0058
1.2000	1007.2654
2.4000	1197.8471
5.4000	1467.0571
8.4000	1549.4976

 Computed Values of Load Distribution and Deflection
 for Lateral Loading for Load Case Number 1

Pile-head boundary conditions are Shear and Moment (BC Type 1)
 Specified shear force at pile head = 1000.000 lbs
 Specified moment at pile head = 1000.000 in-lbs
 Specified axial load at pile head = 1000.000 lbs

Non-zero moment for this load case indicates the pile-head may rotate under the applied pile-head loading, but is not a free-head (zero moment) condition.

Depth Es*h X F/L in lbs/in	Deflect. y in	Moment M lbs-in	Shear V lbs	Slope S Rad.	Total Stress lbs/in**2	Soil Res. p lbs/in
0.000	.842040	1000.0000	1000.0000	-.0439100	75.4245	0.0000
0.0000						
16.900	.115870	18626.1695	79.9959	-.0254339	428.8904	-108.8762
15879.9160						
33.800	-.017628	4563.5284	-560.0804	-.0036032	146.8856	33.1276
31759.8320						
50.700	-.005917	-182.7611	-139.9365	.0005209	59.0360	16.5936
47390.5810						
67.600	-2.25E-05	-183.9316	5.5251	.0001757	59.0595	.6207744
466786.						
84.500	1.99E-05	-1.9501	5.4604	6.7410E-07	55.4101	-.6284370
532561.						
101.400	3.09E-07	.6055504	.0574929	-5.9165E-07	55.3831	-.0109547
598337.						
118.300	-5.55E-08	.0131604	-.0179734	-9.2006E-09	55.3712	.0020238
616768.						
135.200	-1.57E-09	-.0016397	-.0003894	1.6449E-09	55.3710	5.7174E-05

12 inch pipe - stratum 8 through 10.lpo

616768.							
152.100	1.46E-10	-5.8207E-05	4.8681E-05	4.6537E-11	55.3710	-5.3254E-06	
616768.							
169.000	6.34E-12	4.1359E-06	1.7266E-06	-4.3660E-12	55.3710	-2.3126E-07	
616768.							
185.900	-1.65E-12	2.9784E-07	-1.2379E-07	-1.9211E-13	55.3710	1.2282E-08	
125909.							
202.800	-1.57E-13	-4.1897E-08	-8.9123E-09	4.8835E-14	55.3710	1.3139E-09	
141789.							
219.700	2.16E-15	-5.0463E-09	1.2456E-09	4.6434E-15	55.3710	-1.1176E-10	
875533.							
236.600	3.46E-16	4.5969E-11	1.4956E-10	-6.3871E-17	55.3710	-1.7947E-11	
875533.							
253.500	-1.65E-18	1.0967E-11	-1.3704E-12	-1.0271E-17	55.3710	8.5353E-14	
875533.							
270.400	-7.40E-19	-5.2916E-15	-3.2511E-13	4.8698E-20	55.3710	3.8355E-14	
875533.							
287.300	-1.55E-21	-2.3144E-14	1.7551E-16	2.1928E-20	55.3710	1.4061E-16	
1535789.							
304.200	8.30E-22	-1.0063E-16	6.8554E-16	4.5930E-23	55.3710	-8.0250E-17	
1634263.							
321.100	5.15E-24	2.5731E-17	2.9588E-18	-2.4577E-23	55.3710	-5.2889E-19	
1734362.							
338.000	-8.15E-25	2.1294E-19	-7.6217E-19	-1.5271E-25	55.3710	8.8537E-20	
1836160.							
354.900	0.000	-2.5085E-20	-6.2845E-21	0.0000	55.3710	9.1738E-22	
1939740.							
371.800	0.000	-2.9542E-22	7.4305E-22	0.0000	55.3710	-8.5719E-23	
2045190.							
388.700	0.000	2.1660E-23	8.7289E-24	0.0000	55.3710	-1.1825E-24	
2152606.							
405.600	0.000	3.2601E-25	-6.4160E-25	0.0000	55.3710	0.0000	
2262088.							
422.500	0.000	0.0000	0.0000	0.0000	55.3710	0.0000	
2373749.							
439.400	0.000	0.0000	0.0000	0.0000	55.3710	0.0000	
2487708.							
456.300	0.000	0.0000	0.0000	0.0000	55.3710	0.0000	
2604096.							
473.200	0.000	0.0000	0.0000	0.0000	55.3710	0.0000	
2723054.							
490.100	0.000	0.0000	0.0000	0.0000	55.3710	0.0000	
2844737.							
507.000	0.000	0.0000	0.0000	0.0000	55.3710	0.0000	
2969314.							
523.900	0.000	0.0000	0.0000	0.0000	55.3710	0.0000	
5340698.							
540.800	0.000	0.0000	0.0000	0.0000	55.3710	0.0000	
5340698.							
557.700	0.000	0.0000	0.0000	0.0000	55.3710	0.0000	
5340698.							
574.600	0.000	0.0000	0.0000	0.0000	55.3710	0.0000	
5340698.							
591.500	0.000	0.0000	0.0000	0.0000	55.3710	0.0000	
5340698.							
608.400	0.000	0.0000	0.0000	0.0000	55.3710	0.0000	
5340698.							
625.300	0.000	0.0000	0.0000	0.0000	55.3710	0.0000	
6705010.							
642.200	0.000	0.0000	0.0000	0.0000	55.3710	0.0000	
6705010.							
659.100	0.000	0.0000	0.0000	0.0000	55.3710	0.0000	
6705010.							

12 inch pipe - stratum 8 through 10.1po

676.000	0.000	0.0000	0.0000	0.0000	55.3710	0.0000
6705010.						
692.900	0.000	0.0000	0.0000	0.0000	55.3710	0.0000
6705010.						
709.800	0.000	0.0000	0.0000	0.0000	55.3710	0.0000
6705010.						
726.700	0.000	0.0000	0.0000	0.0000	55.3710	0.0000
6705010.						
743.600	0.000	0.0000	0.0000	0.0000	55.3710	0.0000
6705010.						
760.500	0.000	0.0000	0.0000	0.0000	55.3710	0.0000
6705010.						
777.400	0.000	0.0000	0.0000	0.0000	55.3710	0.0000
6705010.						
794.300	0.000	0.0000	0.0000	0.0000	55.3710	0.0000
6705010.						
811.200	0.000	0.0000	0.0000	0.0000	55.3710	0.0000
6705010.						
828.100	0.000	0.0000	0.0000	0.0000	55.3710	0.0000
5486330.						
845.000	0.000	0.0000	0.0000	0.0000	55.3710	0.0000
5486330.						
861.900	0.000	0.0000	0.0000	0.0000	55.3710	0.0000
5486330.						
878.800	0.000	0.0000	0.0000	0.0000	55.3710	0.0000
5486330.						
895.700	0.000	0.0000	0.0000	0.0000	55.3710	0.0000
5486330.						
912.600	0.000	0.0000	0.0000	0.0000	55.3710	0.0000
5486330.						
929.500	0.000	0.0000	0.0000	0.0000	55.3710	0.0000
5486330.						
946.400	0.000	0.0000	0.0000	0.0000	55.3710	0.0000
5486330.						
963.300	0.000	0.0000	0.0000	0.0000	55.3710	0.0000
5486330.						
980.200	0.000	0.0000	0.0000	0.0000	55.3710	0.0000
5486330.						
997.100	0.000	0.0000	0.0000	0.0000	55.3710	0.0000
5486330.						
1014.	0.000	0.0000	0.0000	0.0000	55.3710	0.0000
5486330.						
1031.	0.000	0.0000	0.0000	0.0000	55.3710	0.0000
5486330.						
1048.	0.000	0.0000	0.0000	0.0000	55.3710	0.0000
5486330.						
1065.	0.000	0.0000	0.0000	0.0000	55.3710	0.0000
5486330.						
1082.	0.000	0.0000	0.0000	0.0000	55.3710	0.0000
5486330.						
1099.	0.000	0.0000	0.0000	0.0000	55.3710	0.0000
5486330.						
1115.	0.000	0.0000	0.0000	0.0000	55.3710	0.0000
5486330.						
1132.	0.000	0.0000	0.0000	0.0000	55.3710	0.0000
5486330.						
1149.	0.000	0.0000	0.0000	0.0000	55.3710	0.0000
5486330.						
1166.	0.000	0.0000	0.0000	0.0000	55.3710	0.0000
5486330.						
1183.	0.000	0.0000	0.0000	0.0000	55.3710	0.0000
5486330.						
1200.	0.000	0.0000	0.0000	0.0000	55.3710	0.0000

12 inch pipe - stratum 8 through 10.lpo

5486330.						
1217.	0.000	0.0000	0.0000	0.0000	55.3710	0.0000
7404154.						
1234.	0.000	0.0000	0.0000	0.0000	55.3710	0.0000
7404154.						
1251.	0.000	0.0000	0.0000	0.0000	55.3710	0.0000
7404154.						
1268.	0.000	0.0000	0.0000	0.0000	55.3710	0.0000
7404154.						
1284.	0.000	0.0000	0.0000	0.0000	55.3710	0.0000
7404154.						
1301.	0.000	0.0000	0.0000	0.0000	55.3710	0.0000
7404154.						
1318.	0.000	0.0000	0.0000	0.0000	55.3710	0.0000
7404154.						
1335.	0.000	0.0000	0.0000	0.0000	55.3710	0.0000
7404154.						
1352.	0.000	0.0000	0.0000	0.0000	55.3710	0.0000
7404154.						
1369.	0.000	0.0000	0.0000	0.0000	55.3710	0.0000
1.0911E+07						
1386.	0.000	0.0000	0.0000	0.0000	55.3710	0.0000
1.0911E+07						
1403.	0.000	0.0000	0.0000	0.0000	55.3710	0.0000
1.0911E+07						
1420.	0.000	0.0000	0.0000	0.0000	55.3710	0.0000
1.0911E+07						
1436.	0.000	0.0000	0.0000	0.0000	55.3710	0.0000
1.0911E+07						
1453.	0.000	0.0000	0.0000	0.0000	55.3710	0.0000
1.0911E+07						
1470.	0.000	0.0000	0.0000	0.0000	55.3710	0.0000
1.0911E+07						
1487.	0.000	0.0000	0.0000	0.0000	55.3710	0.0000
1.0911E+07						
1504.	0.000	0.0000	0.0000	0.0000	55.3710	0.0000
1.0911E+07						
1521.	0.000	0.0000	0.0000	0.0000	55.3710	0.0000
1.0911E+07						
1538.	0.000	0.0000	0.0000	0.0000	55.3710	0.0000
1.0911E+07						
1555.	0.000	0.0000	0.0000	0.0000	55.3710	0.0000
1.0911E+07						
1572.	0.000	0.0000	0.0000	0.0000	55.3710	0.0000
1.0911E+07						
1589.	0.000	0.0000	0.0000	0.0000	55.3710	0.0000
1.0911E+07						
1605.	0.000	0.0000	0.0000	0.0000	55.3710	0.0000
1.0911E+07						
1622.	0.000	0.0000	0.0000	0.0000	55.3710	0.0000
1.0911E+07						
1639.	0.000	0.0000	0.0000	0.0000	55.3710	0.0000
1.0911E+07						
1656.	0.000	0.0000	0.0000	0.0000	55.3710	0.0000
1.0911E+07						
1673.	0.000	0.0000	0.0000	0.0000	55.3710	0.0000
1.0911E+07						
1690.	0.000	0.0000	0.0000	0.0000	55.3710	0.0000
5455523.						

Output Verification:

Computed forces and moments are within specified convergence limits.
Page 13

12 inch pipe - stratum 8 through 10.lpo

Output Summary for Load Case No. 1:

Pile-head deflection = .84203969 in
 Computed slope at pile head = -.04391001
 Maximum bending moment = 18626.16954 lbs-in
 Maximum shear force = 1000.00000 lbs
 Depth of maximum bending moment = 16.90000000 in
 Depth of maximum shear force = 0.00000 in
 Number of iterations = 14
 Number of zero deflection points = 49

 Summary of Pile Response(s)

Definition of Symbols for Pile-Head Loading Conditions:

Type 1 = Shear and Moment, y = pile-head displacement in
 Type 2 = Shear and Slope, M = Pile-head Moment lbs-in
 Type 3 = Shear and Rot. Stiffness, V = Pile-head Shear Force lbs
 Type 4 = Deflection and Moment, S = Pile-head Slope, radians
 Type 5 = Deflection and Slope, R = Rot. Stiffness of Pile-head in-lbs/rad

Load Type	Pile-Head Condition 1	Pile-Head Condition 2	Axial Load lbs	Pile-Head Deflection in	Maximum Moment in-lbs	Maximum Shear lbs
1	V= 1000.000	M= 1000.000	1000.0000	.8420397	18626.1695	1000.0000

The analysis ended normally.

18inch pipe - stratum 1 through 4.lpo

LPILE Plus for windows, Version 5.0 (5.0.30)

Analysis of Individual Piles and Drilled Shafts
Subjected to Lateral Loading Using the p-y Method

(c) 1985-2007 by Ensoft, Inc.
All Rights Reserved

This program is licensed to:

DJI
Eustis

Path to file locations: U:\sys\WPDATA\Projects\20749\Piles\LPile\
Name of input data file: 18inch pipe - stratum 1 through 4.lpd
Name of output file: 18inch pipe - stratum 1 through 4.lpo
Name of plot output file: 18inch pipe - stratum 1 through 4.lpp
Name of runtime file: 18inch pipe - stratum 1 through 4.lpr

Time and Date of Analysis

Date: November 9, 2009 Time: 18: 0:16

Problem Title

EE20749 - St. Mary Floodgate Structure at Franklin Drainage Canal

Program Options

Units Used in Computations - US Customary Units: Inches, Pounds

Basic Program Options:

Analysis Type 1:

- Computation of Lateral Pile Response Using User-specified Constant EI

Computation Options:

- Only internally-generated p-y curves used in analysis
- Analysis does not use p-y multipliers (individual pile or shaft action only)
- Analysis assumes no shear resistance at pile tip
- Analysis for fixed-length pile or shaft only
- No computation of foundation stiffness matrix elements
- Output pile response for full length of pile
- Analysis assumes no soil movements acting on pile
- Additional p-y curves computed at specified depths

Solution Control Parameters:

- Number of pile increments = 100
- Maximum number of iterations allowed = 100

18inch pipe - stratum 1 through 4.lpo

- Deflection tolerance for convergence = 1.0000E-05 in
- Maximum allowable deflection = 1.0000E+02 in

Printing Options:

- Values of pile-head deflection, bending moment, shear force, and soil reaction are printed for full length of pile.
- Printing Increment (spacing of output points) = 1

Pile Structural Properties and Geometry

Pile Length = 1690.00 in
Depth of ground surface below top of pile = .00 in
Slope angle of ground surface = .00 deg.

Structural properties of pile defined using 2 points

Point	Depth X in	Pile Diameter in	Moment of Inertia in**4	Pile Area Sq.in	Modulus of Elasticity lbs/Sq.in
1	0.0000	18.00000000	1053.2000	27.4900	30000.00000
2	1690.0000	18.00000000	1053.2000	27.4900	30000.00000

Soil and Rock Layering Information

The soil profile is modelled using 10 layers

Layer 1 is silt with cohesion and friction
Distance from top of pile to top of layer = .000 in
Distance from top of pile to bottom of layer = 36.000 in
p-y subgrade modulus k for top of soil layer = 55.600 lbs/in**3
p-y subgrade modulus k for bottom of layer = 55.600 lbs/in**3

Layer 2 is soft clay, p-y criteria by Matlock, 1970
Distance from top of pile to top of layer = 36.000 in
Distance from top of pile to bottom of layer = 180.000 in

Layer 3 is silt with cohesion and friction
Distance from top of pile to top of layer = 180.000 in
Distance from top of pile to bottom of layer = 204.000 in
p-y subgrade modulus k for top of soil layer = 55.600 lbs/in**3
p-y subgrade modulus k for bottom of layer = 55.600 lbs/in**3

Layer 4 is soft clay, p-y criteria by Matlock, 1970
Distance from top of pile to top of layer = 204.000 in
Distance from top of pile to bottom of layer = 276.000 in

Layer 5 is soft clay, p-y criteria by Matlock, 1970
Distance from top of pile to top of layer = 276.000 in
Distance from top of pile to bottom of layer = 516.000 in

Layer 6 is stiff clay without free water
Distance from top of pile to top of layer = 516.000 in
Distance from top of pile to bottom of layer = 612.000 in

Layer 7 is stiff clay without free water
Distance from top of pile to top of layer = 612.000 in

18inch pipe - stratum 1 through 4.lpo
 Distance from top of pile to bottom of layer = 828.000 in

Layer 8 is stiff clay without free water
 Distance from top of pile to top of layer = 828.000 in
 Distance from top of pile to bottom of layer = 1212.000 in

Layer 9 is stiff clay without free water
 Distance from top of pile to top of layer = 1212.000 in
 Distance from top of pile to bottom of layer = 1356.000 in

Layer 10 is stiff clay without free water
 Distance from top of pile to top of layer = 1356.000 in
 Distance from top of pile to bottom of layer = 1692.000 in

(Depth of lowest layer extends 2.00 in below pile tip)

 Effective Unit Weight of Soil vs. Depth

Distribution of effective unit weight of soil with depth
 is defined using 20 points

Point No.	Depth X in	Eff. Unit Weight lbs/in**3
1	.00	.03160
2	36.00	.03160
3	36.00	.03330
4	180.00	.03330
5	180.00	.03160
6	204.00	.03160
7	204.00	.03480
8	276.00	.03480
9	276.00	.03250
10	516.00	.03250
11	516.00	.03620
12	612.00	.03620
13	612.00	.03550
14	828.00	.03550
15	828.00	.03110
16	1212.00	.03110
17	1212.00	.03040
18	1356.00	.03040
19	1356.00	.03450
20	1692.00	.03450

 Shear Strength of Soils

Distribution of shear strength parameters with depth
 defined using 20 points

Point No.	Depth X in	Cohesion c lbs/in**2	Angle of Friction Deg.	E50 or k _{rm}	RQD %
1	.000	1.38890	15.00	.02000	.0
2	36.000	1.38890	15.00	.02000	.0

18inch pipe - stratum 1 through 4.lpo						
3	36.000	2.20140	.00	.02000	.0	
4	180.000	2.20140	.00	.02000	.0	
5	180.000	1.38890	15.00	.02000	.0	
6	204.000	1.38890	15.00	.02000	.0	
7	204.000	3.12500	.00	.02000	.0	
8	276.000	3.12500	.00	.02000	.0	
9	276.000	4.16670	.00	.01000	.0	
10	516.000	7.63890	.00	.00700	.0	
11	516.000	7.63890	.00	.00700	.0	
12	612.000	7.63890	.00	.00700	.0	
13	612.000	9.59030	.00	.00700	.0	
14	828.000	9.59030	.00	.00700	.0	
15	828.000	7.84720	.00	.00700	.0	
16	1212.000	7.84720	.00	.00700	.0	
17	1212.000	10.59030	.00	.00700	.0	
18	1356.000	10.59030	.00	.00700	.0	
19	1356.000	14.34720	.00	.00500	.0	
20	1692.000	14.34720	.00	.00500	.0	

Notes:

- (1) Cohesion = uniaxial compressive strength for rock materials.
- (2) Values of E50 are reported for clay strata.
- (3) Default values will be generated for E50 when input values are 0.
- (4) RQD and K_{rm} are reported only for weak rock strata.

Loading Type

Cyclic loading criteria was used for computation of p-y curves

Number of cycles of loading = 1000.

Pile-head Loading and Pile-head Fixity Conditions

Number of loads specified = 1

Load Case Number 1

Pile-head boundary conditions are Shear and Moment (BC Type 1)

Shear force at pile head = 1000.000 lbs
 Bending moment at pile head = 1000.000 in-lbs
 Axial load at pile head = 1000.000 lbs

Non-zero moment at pile head for this load case indicates the pile-head may rotate under the applied pile-head loading, but is not a free-head (zero moment) condition.

Output of p-y Curves at Specified Depths

18inch pipe - stratum 1 through 4.lpo

p-y curves are generated and printed for verification at 8 depths.

Depth No.	Depth Below Pile Head in	Depth Below Ground Surface in
1	18.000	18.000
2	48.000	48.000
3	108.000	108.000
4	168.000	168.000
5	192.000	192.000
6	216.000	216.000
7	240.000	240.000
8	264.000	264.000

Depth of ground surface below top of pile = .00 in

Eq.	3.65	15.9203
Eq.	3.66	47.2961
Eq.	3.67	3.9095
Eq.	3.67	97.7391
Eq.	3.69	114.7738
Eq.	3.75	-3.8250
Eq.	3.76	124.4505
Eq.	3.77	.1916

p-y Curve Computed Using the Cyclic Criteria for Cemented Silt

Soil Layer Number	=	1
Depth below pile head	=	18.000 in
Depth below ground surface	=	18.000in
Equivalent Depth	=	18.000in
Pile Diameter	=	18.000in
Cohesion, c	=	1.389lbs/in**2
Angle of Friction	=	15.000 deg.
Avg. Eff. Unit Weight	=	.03160lbs/in**3
k (internal default)	=	55.600lbs/in**3
E50 (internal default)	=	.02000
A parameter	=	1.07000
B parameter	=	.83000
Pu	=	97.739lbs/in
Pc	=	15.920lbs/in
Number of Cycles of Loading	=	1000.
p-multiplier	=	1.00000
y-multiplier	=	1.00000
Pu,c	=	97.739lbs/in
Pc,phi	=	15.920lbs/in

y, in	p, lbs/in
0.0000	0.0000
.0250000	25.0200
.0500000	50.0400
.0750000	75.0600
.1000000	100.0800
.1250000	125.1000
.1500000	150.1200
.1750000	175.1400
.2000000	189.5542
.2250000	183.8063
.2500000	178.8124
.2750000	174.4119

```

18inch pipe - stratum 1 through 4.lpo
.3000000    170.4891
.6750000    114.7738
18.6750     114.7738
36.6750     114.7738
54.6750     114.7738

```

p-y Curve Computed Using the Soft Clay Criteria for Cyclic Loading Conditions

```

Soil Layer Number      =          2
Depth below pile head  =        48.000 in
Depth below ground surface =        48.000 in
Equivalent Depth       =        41.250 in
Pile Diameter          =        18.000 in
Cohesion, c           =        2.201 lbs/in**2
Avg Eff Unit Weight    =        .03203 lbs/in**3
E50 parameter          =        .02000
Default J parameter    =          .500
Y50                    =        .90000 in
p-multiplier           =        1.00000
y-multiplier           =        1.00000
Number of cycles of loading =        1000.
Xr                      =        141.759 in

```

y, in	p, lbs/in
0.0000	0.0000
.0072000	19.9379
.2250000	62.8004
.4500000	79.1235
.6750000	90.5738
.9000000	99.6894
1.1250	107.3872
1.3500	114.1159
1.5750	120.1328
1.8000	125.6008
2.0250	130.6301
2.2500	135.2993
2.4750	139.6668
2.7000	143.5527
7.2000	101.1439
13.5000	41.7716
18.0000	41.7716

p-y Curve Computed Using the Soft Clay Criteria for Cyclic Loading Conditions

```

Soil Layer Number      =          2
Depth below pile head  =       108.000 in
Depth below ground surface =       108.000 in
Equivalent Depth       =       101.250 in
Pile Diameter          =        18.000 in
Cohesion, c           =        2.201 lbs/in**2
Avg Eff Unit Weight    =        .03273 lbs/in**3
E50 parameter          =        .02000
Default J parameter    =          .500
Y50                    =        .90000 in
p-multiplier           =        1.00000
y-multiplier           =        1.00000
Number of cycles of loading =        1000.

```

18inch pipe - stratum 1 through 4.1po

Eq. 3.66 524.8473
 Eq. 3.67 11.1928
 Eq. 3.68 225.0018
 Eq. 3.69 643.7506
 Eq. 3.75 -3.2246
 Eq. 3.76 723.7071
 Eq. 3.77 .1479

p-y Curve Computed Using the Cyclic Criteria for Cemented Silt

Soil Layer Number = 3
 Depth below pile head = 192.000 in
 Depth below ground surface = 192.000in
 Equivalent Depth = 159.246in
 Pile Diameter = 18.000in
 Cohesion, c = 1.389lbs/in**2
 Angle of Friction = 15.000 deg.
 Avg. Eff. Unit Weight = .03288lbs/in**3
 k (internal default) = 55.600lbs/in**3
 E50 (internal default) = .02000
 A parameter = .88000
 B parameter = .55000
 Pu = 225.002lbs/in
 Pc = 475.851lbs/in
 Number of Cycles of Loading = 1000.
 p-multiplier = 1.00000
 y-multiplier = 1.00000
 Pu,c = 225.002lbs/in
 Pc,phi = 475.851lbs/in

y, in	p, lbs/in
0.0000	0.0000
.0250000	221.3523
.0500000	442.7046
.0750000	664.0569
.1000000	885.4092
.1250000	1106.7615
.1500000	1303.3873
.1750000	1242.5445
.2000000	1192.1406
.2250000	1149.3811
.2500000	1112.4327
.2750000	1080.0330
.3000000	1051.2791
.6750000	643.7506
18.6750	643.7506
36.6750	643.7506
54.6750	643.7506

p-y Curve Computed Using the Soft Clay Criteria for Cyclic Loading Conditions

Soil Layer Number = 4
 Depth below pile head = 216.000 in
 Depth below ground surface = 216.000 in
 Equivalent Depth = 267.587 in
 Pile Diameter = 18.000 in
 Cohesion, c = 3.125 lbs/in**2

18inch pipe - stratum 1 through 4.1po

```

Avg Eff Unit Weight = .03291 lbs/in**3
E50 parameter = .02000
Default J parameter = .500
Y50 = .90000 in
p-multiplier = 1.00000
y-multiplier = 1.00000
Number of cycles of loading = 1000.
Xr = 156.620 in

```

y, in	p, lbs/in
0.0000	0.0000
.0072000	50.6250
.2250000	159.4588
.4500000	200.9054
.6750000	229.9793
.9000000	253.1250
1.1250	272.6706
1.3500	289.7558
1.5750	305.0336
1.8000	318.9175
2.0250	331.6876
2.2500	343.5435
2.4750	354.6331
2.7000	364.5000
7.2000	364.5000
13.5000	364.5000
18.0000	364.5000

p-y Curve Computed Using the Soft Clay Criteria for Cyclic Loading Conditions

```

Soil Layer Number = 4
Depth below pile head = 240.000 in
Depth below ground surface = 240.000 in
Equivalent Depth = 291.587 in
Pile Diameter = 18.000 in
Cohesion, c = 3.125 lbs/in**2
Avg Eff Unit Weight = .03310 lbs/in**3
E50 parameter = .02000
Default J parameter = .500
Y50 = .90000 in
p-multiplier = 1.00000
y-multiplier = 1.00000
Number of cycles of loading = 1000.
Xr = 156.373 in

```

y, in	p, lbs/in
0.0000	0.0000
.0072000	50.6250
.2250000	159.4588
.4500000	200.9054
.6750000	229.9793
.9000000	253.1250
1.1250	272.6706
1.3500	289.7558
1.5750	305.0336
1.8000	318.9175
2.0250	331.6876
2.2500	343.5435
2.4750	354.6331
2.7000	364.5000

	18inch pipe - stratum 1 through 4.lpo
7.2000	364.5000
13.5000	364.5000
18.0000	364.5000

p-y Curve Computed Using the Soft Clay Criteria for Cyclic Loading Conditions

Soil Layer Number	=	4
Depth below pile head	=	264.000 in
Depth below ground surface	=	264.000 in
Equivalent Depth	=	315.587 in
Pile Diameter	=	18.000 in
Cohesion, c	=	3.125 lbs/in**2
Avg Eff Unit weight	=	.03325 lbs/in**3
E50 parameter	=	.02000
Default J parameter	=	.500
Y50	=	.90000 in
p-multiplier	=	1.00000
y-multiplier	=	1.00000
Number of cycles of loading	=	1000.
Xr	=	156.172 in

y, in	p, lbs/in
0.0000	0.0000
.0072000	50.6250
.2250000	159.4588
.4500000	200.9054
.6750000	229.9793
.9000000	253.1250
1.1250	272.6706
1.3500	289.7558
1.5750	305.0336
1.8000	318.9175
2.0250	331.6876
2.2500	343.5435
2.4750	354.6331
2.7000	364.5000
7.2000	364.5000
13.5000	364.5000
18.0000	364.5000

 Computed Values of Load Distribution and Deflection
 for Lateral Loading for Load Case Number 1

Pile-head boundary conditions are Shear and Moment (BC Type 1)
 Specified shear force at pile head = 1000.000 lbs
 Specified moment at pile head = 1000.000 in-lbs
 Specified axial load at pile head = 1000.000 lbs

Non-zero moment for this load case indicates the pile-head may rotate under the applied pile-head loading, but is not a free-head (zero moment) condition.

Depth	Deflect.	Moment	Shear	Slope	Total	Soil Res.
Es*h	y	M	V	S	Stress	p
F/L	X					

18inch pipe - stratum 1 through 4.1po						
in lbs/in	in	lbs-in	lbs	Rad.	lbs/in**2	lbs/in
0.000	.354019	1000.0000	1000.0000	-.0156145	44.9222	0.0000
0.0000						
16.900	.094653	18159.3660	248.4614	-.0104906	191.5556	-88.9395
15879.9160						
33.800	-.000563	9752.5782	-494.1384	-.0030258	119.7164	1.0578
31759.8320						
50.700	-.007621	1559.7602	-309.4562	-4.8097E-07	49.7056	20.7981
46122.7088						
67.600	-.000579	-707.0240	-48.2473	.0002276	42.4187	10.1142
295141.						
84.500	7.13E-05	-78.6901	21.0993	1.7443E-05	37.0493	-1.9075
452134.						
101.400	1.04E-05	5.5417	2.3619	-2.1194E-06	36.4242	-.3098926
501824.						
118.300	-3.34E-07	1.2151	-.1645787	-3.1233E-07	36.3872	.0108963
551514.						
135.200	-1.20E-07	-.0104613	-.0363204	9.8366E-09	36.3770	.0042822
601204.						
152.100	-1.42E-09	-.0128751	.0003016	3.5955E-09	36.3770	5.1763E-05
616768.						
169.000	1.15E-09	-.0003884	.0003833	4.8293E-11	36.3769	-4.2095E-05
616768.						
185.900	2.14E-10	7.9146E-05	1.2218E-05	-3.4424E-11	36.3769	-1.8218E-06
143902.						
202.800	-1.01E-11	2.5701E-05	-2.3690E-06	-6.3837E-12	36.3769	9.5458E-08
159782.						
219.700	-1.82E-12	-7.1219E-07	-7.6613E-07	2.9932E-13	36.3769	9.4236E-08
875533.						
236.600	2.07E-14	-2.0430E-07	2.1104E-08	5.4219E-14	36.3769	-1.0719E-09
875533.						
253.500	1.36E-14	-6.9720E-10	6.0866E-09	-6.0504E-16	36.3769	-7.0538E-10
875533.						
270.400	2.39E-16	1.4475E-09	2.1345E-11	-4.0439E-16	36.3769	-1.2398E-11
875533.						
287.300	-5.27E-17	3.7930E-11	-4.2992E-11	-7.1325E-18	36.3769	4.7846E-12
1535789.						
304.200	-1.76E-18	-5.4175E-12	-1.1275E-12	1.5627E-18	36.3769	1.6976E-13
1634263.						
321.100	1.69E-19	-2.3057E-13	1.6083E-13	5.2189E-20	36.3769	-1.7302E-14
1734362.						
338.000	8.47E-21	1.6728E-14	6.8472E-15	-5.0013E-21	36.3769	-9.2029E-16
1836160.						
354.900	-4.46E-22	1.0322E-15	-4.9641E-16	-2.5155E-22	36.3769	5.1226E-17
1939740.						
371.800	-3.22E-23	-4.2147E-17	-3.0637E-17	1.3232E-23	36.3769	3.8948E-18
2045190.						
388.700	9.51E-25	-3.7593E-18	1.2503E-18	9.5520E-25	36.3769	-1.2107E-19
2152606.						
405.600	1.02E-25	8.2354E-20	1.1154E-19	0.0000	36.3769	-1.3696E-20
2262088.						
422.500	0.000	1.1615E-20	-2.4425E-21	0.0000	36.3769	2.0703E-22
2373749.						
439.400	0.000	-1.0094E-22	-3.4450E-22	0.0000	36.3769	4.1261E-23
2487708.						
456.300	0.000	-3.1130E-23	2.9932E-24	0.0000	36.3769	-1.3659E-25
2604096.						
473.200	0.000	0.0000	9.2316E-25	0.0000	36.3769	-1.0839E-25
2723054.						
490.100	0.000	0.0000	0.0000	0.0000	36.3769	0.0000

18inch pipe - stratum 1 through 4.lpo

2844737.						
507.000	0.000	0.0000	0.0000	0.0000	36.3769	0.0000
2969314.						
523.900	0.000	0.0000	0.0000	0.0000	36.3769	0.0000
5340698.						
540.800	0.000	0.0000	0.0000	0.0000	36.3769	0.0000
5340698.						
557.700	0.000	0.0000	0.0000	0.0000	36.3769	0.0000
5340698.						
574.600	0.000	0.0000	0.0000	0.0000	36.3769	0.0000
5340698.						
591.500	0.000	0.0000	0.0000	0.0000	36.3769	0.0000
5340698.						
608.400	0.000	0.0000	0.0000	0.0000	36.3769	0.0000
5340698.						
625.300	0.000	0.0000	0.0000	0.0000	36.3769	0.0000
6705010.						
642.200	0.000	0.0000	0.0000	0.0000	36.3769	0.0000
6705010.						
659.100	0.000	0.0000	0.0000	0.0000	36.3769	0.0000
6705010.						
676.000	0.000	0.0000	0.0000	0.0000	36.3769	0.0000
6705010.						
692.900	0.000	0.0000	0.0000	0.0000	36.3769	0.0000
6705010.						
709.800	0.000	0.0000	0.0000	0.0000	36.3769	0.0000
6705010.						
726.700	0.000	0.0000	0.0000	0.0000	36.3769	0.0000
6705010.						
743.600	0.000	0.0000	0.0000	0.0000	36.3769	0.0000
6705010.						
760.500	0.000	0.0000	0.0000	0.0000	36.3769	0.0000
6705010.						
777.400	0.000	0.0000	0.0000	0.0000	36.3769	0.0000
6705010.						
794.300	0.000	0.0000	0.0000	0.0000	36.3769	0.0000
6705010.						
811.200	0.000	0.0000	0.0000	0.0000	36.3769	0.0000
6705010.						
828.100	0.000	0.0000	0.0000	0.0000	36.3769	0.0000
5486330.						
845.000	0.000	0.0000	0.0000	0.0000	36.3769	0.0000
5486330.						
861.900	0.000	0.0000	0.0000	0.0000	36.3769	0.0000
5486330.						
878.800	0.000	0.0000	0.0000	0.0000	36.3769	0.0000
5486330.						
895.700	0.000	0.0000	0.0000	0.0000	36.3769	0.0000
5486330.						
912.600	0.000	0.0000	0.0000	0.0000	36.3769	0.0000
5486330.						
929.500	0.000	0.0000	0.0000	0.0000	36.3769	0.0000
5486330.						
946.400	0.000	0.0000	0.0000	0.0000	36.3769	0.0000
5486330.						
963.300	0.000	0.0000	0.0000	0.0000	36.3769	0.0000
5486330.						
980.200	0.000	0.0000	0.0000	0.0000	36.3769	0.0000
5486330.						
997.100	0.000	0.0000	0.0000	0.0000	36.3769	0.0000
5486330.						
1014.	0.000	0.0000	0.0000	0.0000	36.3769	0.0000
5486330.						

18inch pipe - stratum 1 through 4.lpo						
1031.	0.000	0.0000	0.0000	0.0000	36.3769	0.0000
5486330.						
1048.	0.000	0.0000	0.0000	0.0000	36.3769	0.0000
5486330.						
1065.	0.000	0.0000	0.0000	0.0000	36.3769	0.0000
5486330.						
1082.	0.000	0.0000	0.0000	0.0000	36.3769	0.0000
5486330.						
1099.	0.000	0.0000	0.0000	0.0000	36.3769	0.0000
5486330.						
1115.	0.000	0.0000	0.0000	0.0000	36.3769	0.0000
5486330.						
1132.	0.000	0.0000	0.0000	0.0000	36.3769	0.0000
5486330.						
1149.	0.000	0.0000	0.0000	0.0000	36.3769	0.0000
5486330.						
1166.	0.000	0.0000	0.0000	0.0000	36.3769	0.0000
5486330.						
1183.	0.000	0.0000	0.0000	0.0000	36.3769	0.0000
5486330.						
1200.	0.000	0.0000	0.0000	0.0000	36.3769	0.0000
5486330.						
1217.	0.000	0.0000	0.0000	0.0000	36.3769	0.0000
7404154.						
1234.	0.000	0.0000	0.0000	0.0000	36.3769	0.0000
7404154.						
1251.	0.000	0.0000	0.0000	0.0000	36.3769	0.0000
7404154.						
1268.	0.000	0.0000	0.0000	0.0000	36.3769	0.0000
7404154.						
1284.	0.000	0.0000	0.0000	0.0000	36.3769	0.0000
7404154.						
1301.	0.000	0.0000	0.0000	0.0000	36.3769	0.0000
7404154.						
1318.	0.000	0.0000	0.0000	0.0000	36.3769	0.0000
7404154.						
1335.	0.000	0.0000	0.0000	0.0000	36.3769	0.0000
7404154.						
1352.	0.000	0.0000	0.0000	0.0000	36.3769	0.0000
7404154.						
1369.	0.000	0.0000	0.0000	0.0000	36.3769	0.0000
1.0911E+07						
1386.	0.000	0.0000	0.0000	0.0000	36.3769	0.0000
1.0911E+07						
1403.	0.000	0.0000	0.0000	0.0000	36.3769	0.0000
1.0911E+07						
1420.	0.000	0.0000	0.0000	0.0000	36.3769	0.0000
1.0911E+07						
1436.	0.000	0.0000	0.0000	0.0000	36.3769	0.0000
1.0911E+07						
1453.	0.000	0.0000	0.0000	0.0000	36.3769	0.0000
1.0911E+07						
1470.	0.000	0.0000	0.0000	0.0000	36.3769	0.0000
1.0911E+07						
1487.	0.000	0.0000	0.0000	0.0000	36.3769	0.0000
1.0911E+07						
1504.	0.000	0.0000	0.0000	0.0000	36.3769	0.0000
1.0911E+07						
1521.	0.000	0.0000	0.0000	0.0000	36.3769	0.0000
1.0911E+07						
1538.	0.000	0.0000	0.0000	0.0000	36.3769	0.0000
1.0911E+07						
1555.	0.000	0.0000	0.0000	0.0000	36.3769	0.0000

18inch pipe - stratum 1 through 4.lpo

1.0911E+07						
1572.	0.000	0.0000	0.0000	0.0000	36.3769	0.0000
1.0911E+07						
1589.	0.000	0.0000	0.0000	0.0000	36.3769	0.0000
1.0911E+07						
1605.	0.000	0.0000	0.0000	0.0000	36.3769	0.0000
1.0911E+07						
1622.	0.000	0.0000	0.0000	0.0000	36.3769	0.0000
1.0911E+07						
1639.	0.000	0.0000	0.0000	0.0000	36.3769	0.0000
1.0911E+07						
1656.	0.000	0.0000	0.0000	0.0000	36.3769	0.0000
1.0911E+07						
1673.	0.000	0.0000	0.0000	0.0000	36.3769	0.0000
1.0911E+07						
1690.	0.000	0.0000	0.0000	0.0000	36.3769	0.0000
5455523.						

Output Verification:

Computed forces and moments are within specified convergence limits.

Output Summary for Load Case No. 1:

Pile-head deflection = .35401873 in
 Computed slope at pile head = -.01561454
 Maximum bending moment = 18159.36602 lbs-in
 Maximum shear force = 1000.00000 lbs
 Depth of maximum bending moment = 16.90000000 in
 Depth of maximum shear force = 0.00000 in
 Number of iterations = 13
 Number of zero deflection points = 47

 Summary of Pile Response(s)

Definition of symbols for Pile-Head Loading Conditions:

Type 1 = Shear and Moment, y = pile-head displacement in
 Type 2 = Shear and Slope, M = Pile-head Moment lbs-in
 Type 3 = Shear and Rot. Stiffness, V = Pile-head Shear Force lbs
 Type 4 = Deflection and Moment, S = Pile-head Slope, radians
 Type 5 = Deflection and Slope, R = Rot. Stiffness of Pile-head in-lbs/rad

Load Type	Pile-Head Condition 1	Pile-Head Condition 2	Axial Load lbs	Pile-Head Deflection in	Maximum Moment in-lbs	Maximum Shear lbs
1	V= 1000.000	M= 1000.000	1000.0000	.3540187	18159.3660	1000.0000

The analysis ended normally.

18 inch pipe - stratum 5 through 7.lpo

LPILE Plus for windows, Version 5.0 (5.0.30)

Analysis of Individual Piles and Drilled Shafts
Subjected to Lateral Loading Using the p-y Method

(c) 1985-2007 by Ensoft, Inc.
All Rights Reserved

This program is licensed to:

DJI
Eustis

Path to file locations: U:\sys\WPDATA\Projects\20749\Piles\LPile\
Name of input data file: 18 inch pipe - stratum 5 through 7.lpd
Name of output file: 18 inch pipe - stratum 5 through 7.lpo
Name of plot output file: 18 inch pipe - stratum 5 through 7.lpp
Name of runtime file: 18 inch pipe - stratum 5 through 7.lpr

Time and Date of Analysis

Date: November 9, 2009 Time: 18: 2:44

Problem Title

EE20749 - St. Mary Floodgate Structure at Franklin Drainage Canal

Program Options

Units Used in Computations - US Customary Units: Inches, Pounds

Basic Program Options:

Analysis Type 1:

- Computation of Lateral Pile Response Using User-specified Constant EI

Computation Options:

- Only internally-generated p-y curves used in analysis
- Analysis does not use p-y multipliers (individual pile or shaft action only)
- Analysis assumes no shear resistance at pile tip
- Analysis for fixed-length pile or shaft only
- No computation of foundation stiffness matrix elements
- Output pile response for full length of pile
- Analysis assumes no soil movements acting on pile
- Additional p-y curves computed at specified depths

Solution Control Parameters:

- Number of pile increments = 100
- Maximum number of iterations allowed = 100

18 inch pipe - stratum 5 through 7.lpo

- Deflection tolerance for convergence = 1.0000E-05 in
- Maximum allowable deflection = 1.0000E+02 in

Printing Options:

- Values of pile-head deflection, bending moment, shear force, and soil reaction are printed for full length of pile.
- Printing Increment (spacing of output points) = 1

Pile Structural Properties and Geometry

Pile Length = 1690.00 in
Depth of ground surface below top of pile = .00 in
Slope angle of ground surface = .00 deg.

Structural properties of pile defined using 2 points

Point	Depth X in	Pile Diameter in	Moment of Inertia in**4	Pile Area Sq.in	Modulus of Elasticity lbs/Sq.in
1	0.0000	18.00000000	1053.2000	27.4900	30000.00000
2	1690.0000	18.00000000	1053.2000	27.4900	30000.00000

Soil and Rock Layering Information

The soil profile is modelled using 10 layers

Layer 1 is silt with cohesion and friction
Distance from top of pile to top of layer = .000 in
Distance from top of pile to bottom of layer = 36.000 in
p-y subgrade modulus k for top of soil layer = 55.600 lbs/in**3
p-y subgrade modulus k for bottom of layer = 55.600 lbs/in**3

Layer 2 is soft clay, p-y criteria by Matlock, 1970
Distance from top of pile to top of layer = 36.000 in
Distance from top of pile to bottom of layer = 180.000 in

Layer 3 is silt with cohesion and friction
Distance from top of pile to top of layer = 180.000 in
Distance from top of pile to bottom of layer = 204.000 in
p-y subgrade modulus k for top of soil layer = 55.600 lbs/in**3
p-y subgrade modulus k for bottom of layer = 55.600 lbs/in**3

Layer 4 is soft clay, p-y criteria by Matlock, 1970
Distance from top of pile to top of layer = 204.000 in
Distance from top of pile to bottom of layer = 276.000 in

Layer 5 is soft clay, p-y criteria by Matlock, 1970
Distance from top of pile to top of layer = 276.000 in
Distance from top of pile to bottom of layer = 516.000 in

Layer 6 is stiff clay without free water
Distance from top of pile to top of layer = 516.000 in
Distance from top of pile to bottom of layer = 612.000 in

Layer 7 is stiff clay without free water
Distance from top of pile to top of layer = 612.000 in

18 inch pipe - stratum 5 through 7.1po
 Distance from top of pile to bottom of layer = 828.000 in

Layer 8 is stiff clay without free water
 Distance from top of pile to top of layer = 828.000 in
 Distance from top of pile to bottom of layer = 1212.000 in

Layer 9 is stiff clay without free water
 Distance from top of pile to top of layer = 1212.000 in
 Distance from top of pile to bottom of layer = 1356.000 in

Layer 10 is stiff clay without free water
 Distance from top of pile to top of layer = 1356.000 in
 Distance from top of pile to bottom of layer = 1692.000 in

(Depth of lowest layer extends 2.00 in below pile tip)

 Effective Unit Weight of Soil vs. Depth

Distribution of effective unit weight of soil with depth
 is defined using 20 points

Point No.	Depth X in	Eff. Unit Weight lbs/in**3
1	.00	.03160
2	36.00	.03160
3	36.00	.03330
4	180.00	.03330
5	180.00	.03160
6	204.00	.03160
7	204.00	.03480
8	276.00	.03480
9	276.00	.03250
10	516.00	.03250
11	516.00	.03620
12	612.00	.03620
13	612.00	.03550
14	828.00	.03550
15	828.00	.03110
16	1212.00	.03110
17	1212.00	.03040
18	1356.00	.03040
19	1356.00	.03450
20	1692.00	.03450

 Shear Strength of Soils

Distribution of shear strength parameters with depth
 defined using 20 points

Point No.	Depth X in	Cohesion c lbs/in**2	Angle of Friction Deg.	E50 or k_rm	RQD %
1	.000	1.38890	15.00	.02000	.0
2	36.000	1.38890	15.00	.02000	.0

18 inch pipe - stratum 5 through 7.lpo					
3	36.000	2.20140	.00	.02000	.0
4	180.000	2.20140	.00	.02000	.0
5	180.000	1.38890	15.00	.02000	.0
6	204.000	1.38890	15.00	.02000	.0
7	204.000	3.12500	.00	.02000	.0
8	276.000	3.12500	.00	.02000	.0
9	276.000	4.16670	.00	.01000	.0
10	516.000	7.63890	.00	.00700	.0
11	516.000	7.63890	.00	.00700	.0
12	612.000	7.63890	.00	.00700	.0
13	612.000	9.59030	.00	.00700	.0
14	828.000	9.59030	.00	.00700	.0
15	828.000	7.84720	.00	.00700	.0
16	1212.000	7.84720	.00	.00700	.0
17	1212.000	10.59030	.00	.00700	.0
18	1356.000	10.59030	.00	.00700	.0
19	1356.000	14.34720	.00	.00500	.0
20	1692.000	14.34720	.00	.00500	.0

Notes:

- (1) Cohesion = uniaxial compressive strength for rock materials.
- (2) Values of E50 are reported for clay strata.
- (3) Default values will be generated for E50 when input values are 0.
- (4) RQD and k_{rm} are reported only for weak rock strata.

Loading Type

Cyclic loading criteria was used for computation of p-y curves

Number of cycles of loading = 1000.

Pile-head Loading and Pile-head Fixity Conditions

Number of loads specified = 1

Load Case Number 1

Pile-head boundary conditions are Shear and Moment (BC Type 1)

Shear force at pile head = 1000.000 lbs
 Bending moment at pile head = 1000.000 in-lbs
 Axial load at pile head = 1000.000 lbs

Non-zero moment at pile head for this load case indicates the pile-head may rotate under the applied pile-head loading, but is not a free-head (zero moment) condition.

Output of p-y Curves at Specified Depths

18 inch pipe - stratum 5 through 7.1po

p-y curves are generated and printed for verification at 9 depths.

Depth No.	Depth Below Pile Head in	Depth Below Ground Surface in
1	288.000	288.000
2	396.000	396.000
3	504.000	504.000
4	528.000	528.000
5	564.000	564.000
6	600.000	600.000
7	624.000	624.000
8	720.000	720.000
9	816.000	816.000

Depth of ground surface below top of pile = .00 in

p-y Curve Computed Using the Soft Clay Criteria for Cyclic Loading Conditions

Soil Layer Number = 5
 Depth below pile head = 288.000 in
 Depth below ground surface = 288.000 in
 Equivalent Depth = 284.312 in
 Pile Diameter = 18.000 in
 Cohesion, c = 4.340 lbs/in**2
 Avg Eff Unit Weight = .03329 lbs/in**3
 E50 parameter = .00985
 Default J parameter = .500
 Y50 = .44325 in
 p-multiplier = 1.00000
 y-multiplier = 1.00000
 Number of cycles of loading = 1000.
 Xr = 169.266 in

y, in	p, lbs/in
0.0000	0.0000
.0035460	70.3130
.1108125	221.4721
.2216250	279.0374
.3324375	319.4181
.4432500	351.5651
.5540625	378.7120
.6648750	402.4416
.7756875	423.6610
.8865000	442.9443
.9973125	460.6806
1.1081	477.1473
1.2189	492.5496
1.3298	507.0446
3.5460	506.2538
6.6487	506.2538
8.8650	506.2538

p-y Curve Computed Using the Soft Clay Criteria for Cyclic Loading Conditions

Soil Layer Number = 5
 Depth below pile head = 396.000 in
 Depth below ground surface = 396.000 in
 Page 5

18 inch pipe - stratum 5 through 7.lpo

Equivalent Depth = 392.312 in
 Pile Diameter = 18.000 in
 Cohesion, c = 5.903 lbs/in**2
 Avg Eff Unit Weight = .03307 lbs/in**3
 E50 parameter = .00850
 Default J parameter = .500
 Y50 = .38250 in
 p-multiplier = 1.00000
 y-multiplier = 1.00000
 Number of cycles of loading = 1000.
 Xr = 179.745 in

y, in	p, lbs/in
0.0000	0.0000
.0030600	95.6254
.0956250	301.2010
.1912500	379.4895
.2868750	434.4070
.3825000	478.1268
.4781250	515.0465
.5737500	547.3186
.6693750	576.1768
.7650000	602.4020
.8606250	626.5234
.9562500	648.9179
1.0519	669.8651
1.1475	688.5026
3.0600	688.5026
5.7375	688.5026
7.6500	688.5026

p-y Curve Computed Using the Soft Clay Criteria for Cyclic Loading Conditions

Soil Layer Number = 5
 Depth below pile head = 504.000 in
 Depth below ground surface = 504.000 in
 Equivalent Depth = 500.312 in
 Pile Diameter = 18.000 in
 Cohesion, c = 7.465 lbs/in**2
 Avg Eff Unit Weight = .03295 lbs/in**3
 E50 parameter = .00715
 Default J parameter = .500
 Y50 = .32175 in
 p-multiplier = 1.00000
 y-multiplier = 1.00000
 Number of cycles of loading = 1000.
 Xr = 186.384 in

y, in	p, lbs/in
0.0000	0.0000
.0025740	120.9377
.0804375	380.9299
.1608750	479.9416
.2413125	549.3960
.3217500	604.6885
.4021875	651.3809
.4826250	692.1955
.5630625	728.6926
.6435000	761.8598
.7239375	792.3661

18 inch pipe - stratum 5 through 7.lpo

.8043750	820.6886
.8848125	847.1805
.9652500	870.7515
2.5740	870.7515
4.8263	870.7515
6.4350	870.7515

p-y Curve Computed Using Cyclic Criteria for Stiff Clay without Free Water

Soil Layer Number	=	6
Depth below pile head	=	528.000 in
Depth below ground surface	=	528.000 in
Equivalent Depth	=	282.447 in
Diameter	=	18.000 in
Undrained cohesion, c	=	7.63890 lbs/in**2
Average Eff. Unit Weight	=	.03301 lbs/in**3
Epsilon-50	=	.00700
Pct	=	1659.137 lbs/in
Pcd	=	1237.502 lbs/in
Pu	=	1237.502 lbs/in
y50	=	.315 in
p-multiplier	=	1.00000
y-multiplier	=	1.00000
Number of cycles of loading	=	1000.

y, in	p, lbs/in
0.0000	0.0000
5.0400E-05	53.7968
.0002520	80.4450
.0005040	95.6657
.0025200	143.0536
.0050400	170.1204
.0252000	254.3893
.0504000	302.5216
.1260000	380.4007
.2520000	452.3752
.3780000	500.6355
.5040000	537.9679
1.2600	676.4588
2.5200	804.4496
5.0400	956.6572
11.3400	1171.6610
17.6400	1237.5018

p-y Curve Computed Using Cyclic Criteria for Stiff Clay without Free Water

Soil Layer Number	=	6
Depth below pile head	=	564.000 in
Depth below ground surface	=	564.000 in
Equivalent Depth	=	318.447 in
Diameter	=	18.000 in
Undrained cohesion, c	=	7.63890 lbs/in**2
Average Eff. Unit Weight	=	.03322 lbs/in**3
Epsilon-50	=	.00700
Pct	=	1819.196 lbs/in
Pcd	=	1237.502 lbs/in
Pu	=	1237.502 lbs/in

18 inch pipe - stratum 5 through 7.1po
y50 = .315 in
p-multiplier = 1.00000
y-multiplier = 1.00000
Number of cycles of loading = 1000.

y, in	p, lbs/in
0.0000	0.0000
5.0400E-05	53.7968
.0002520	80.4450
.0005040	95.6657
.0025200	143.0536
.0050400	170.1204
.0252000	254.3893
.0504000	302.5216
.1260000	380.4007
.2520000	452.3752
.3780000	500.6355
.5040000	537.9679
1.2600	676.4588
2.5200	804.4496
5.0400	956.6572
11.3400	1171.6610
17.6400	1237.5018

p-y Curve Computed Using Cyclic Criteria for Stiff Clay without Free Water

Soil Layer Number = 6
Depth below pile head = 600.000 in
Depth below ground surface = 600.000 in
Equivalent Depth = 354.447 in
Diameter = 18.000 in
Undrained cohesion, c = 7.63890 lbs/in**2
Average Eff. Unit Weight = .03340 lbs/in**3
Epsilon-50 = .00700
Pct = 1979.363 lbs/in
Pcd = 1237.502 lbs/in
Pu = 1237.502 lbs/in
y50 = .315 in
p-multiplier = 1.00000
y-multiplier = 1.00000
Number of cycles of loading = 1000.

y, in	p, lbs/in
0.0000	0.0000
5.0400E-05	53.7968
.0002520	80.4450
.0005040	95.6657
.0025200	143.0536
.0050400	170.1204
.0252000	254.3893
.0504000	302.5216
.1260000	380.4007
.2520000	452.3752
.3780000	500.6355
.5040000	537.9679
1.2600	676.4588
2.5200	804.4496
5.0400	956.6572
11.3400	1171.6610
17.6400	1237.5018

18 inch pipe - stratum 5 through 7.lpo

p-y Curve Computed Using Cyclic Criteria for Stiff Clay without Free Water

Soil Layer Number = 7
 Depth below pile head = 624.000 in
 Depth below ground surface = 624.000 in
 Equivalent Depth = 311.916 in
 Diameter = 18.000 in
 Undrained cohesion, c = 9.59030 lbs/in**2
 Average Eff. Unit Weight = .03349 lbs/in**3
 Epsilon-50 = .00700
 Pct = 2201.594 lbs/in
 Pcd = 1553.629 lbs/in
 Pu = 1553.629 lbs/in
 y50 = .315 in
 p-multiplier = 1.00000
 y-multiplier = 1.00000
 Number of cycles of loading = 1000.

y, in	p, lbs/in
0.0000	0.0000
5.0400E-05	67.5395
.0002520	100.9951
.0005040	120.1041
.0025200	179.5975
.0050400	213.5786
.0252000	319.3745
.0504000	379.8024
.1260000	477.5762
.2520000	567.9370
.3780000	628.5257
.5040000	675.3948
1.2600	849.2640
2.5200	1009.9508
5.0400	1201.0406
11.3400	1470.9684
17.6400	1553.6286

p-y Curve Computed Using Cyclic Criteria for Stiff Clay without Free Water

Soil Layer Number = 7
 Depth below pile head = 720.000 in
 Depth below ground surface = 720.000 in
 Equivalent Depth = 407.916 in
 Diameter = 18.000 in
 Undrained cohesion, c = 9.59030 lbs/in**2
 Average Eff. Unit Weight = .03376 lbs/in**3
 Epsilon-50 = .00700
 Pct = 2721.767 lbs/in
 Pcd = 1553.629 lbs/in
 Pu = 1553.629 lbs/in
 y50 = .315 in
 p-multiplier = 1.00000
 y-multiplier = 1.00000
 Number of cycles of loading = 1000.

y, in p, lbs/in

18 inch pipe - stratum 5 through 7.lpo

0.0000	0.0000
5.0400E-05	67.5395
.0002520	100.9951
.0005040	120.1041
.0025200	179.5975
.0050400	213.5786
.0252000	319.3745
.0504000	379.8024
.1260000	477.5762
.2520000	567.9370
.3780000	628.5257
.5040000	675.3948
1.2600	849.2640
2.5200	1009.9508
5.0400	1201.0406
11.3400	1470.9684
17.6400	1553.6286

p-y Curve Computed Using Cyclic Criteria for Stiff Clay without Free Water

Soil Layer Number	=	7
Depth below pile head	=	816.000 in
Depth below ground surface	=	816.000 in
Equivalent Depth	=	503.916 in
Diameter	=	18.000 in
Undrained cohesion, c	=	9.59030 lbs/in**2
Average Eff. Unit Weight	=	.03396 lbs/in**3
Epsilon-50	=	.00700
Pct	=	3242.294 lbs/in
Pcd	=	1553.629 lbs/in
Pu	=	1553.629 lbs/in
y50	=	.315 in
p-multiplier	=	1.00000
y-multiplier	=	1.00000
Number of cycles of loading	=	1000.

y, in	p, lbs/in
0.0000	0.0000
5.0400E-05	67.5395
.0002520	100.9951
.0005040	120.1041
.0025200	179.5975
.0050400	213.5786
.0252000	319.3745
.0504000	379.8024
.1260000	477.5762
.2520000	567.9370
.3780000	628.5257
.5040000	675.3948
1.2600	849.2640
2.5200	1009.9508
5.0400	1201.0406
11.3400	1470.9684
17.6400	1553.6286

18 inch pipe - stratum 5 through 7.1po
 Computed Values of Load Distribution and Deflection
 for Lateral Loading for Load Case Number 1

Pile-head boundary conditions are Shear and Moment (BC Type 1)
 Specified shear force at pile head = 1000.000 lbs
 Specified moment at pile head = 1000.000 in-lbs
 Specified axial load at pile head = 1000.000 lbs

Non-zero moment for this load case indicates the pile-head may rotate under the applied pile-head loading, but is not a free-head (zero moment) condition.

Depth Es*h	Deflect. y	Moment M	Shear V	Slope S	Total Stress	Soil Res. p
F/L lbs/in	in	lbs-in	lbs	Rad.	lbs/in**2	lbs/in
0.000	.354019	1000.0000	1000.0000	-.0156145	44.9222	0.0000
0.0000						
16.900	.094653	18159.3660	248.4614	-.0104906	191.5556	-88.9395
15879.9160						
33.800	-.000563	9752.5782	-494.1384	-.0030258	119.7164	1.0578
31759.8320						
50.700	-.007621	1559.7602	-309.4562	-4.8097E-07	49.7056	20.7981
46122.7088						
67.600	-.000579	-707.0240	-48.2473	.0002276	42.4187	10.1142
295141.						
84.500	7.13E-05	-78.6901	21.0993	1.7443E-05	37.0493	-1.9075
452134.						
101.400	1.04E-05	5.5417	2.3619	-2.1194E-06	36.4242	-.3098926
501824.						
118.300	-3.34E-07	1.2151	-.1645787	-3.1233E-07	36.3872	.0108963
551514.						
135.200	-1.20E-07	-.0104613	-.0363204	9.8366E-09	36.3770	.0042822
601204.						
152.100	-1.42E-09	-.0128751	.0003016	3.5955E-09	36.3770	5.1763E-05
616768.						
169.000	1.15E-09	-.0003884	.0003833	4.8293E-11	36.3769	-4.2095E-05
616768.						
185.900	2.14E-10	7.9146E-05	1.2218E-05	-3.4424E-11	36.3769	-1.8218E-06
143902.						
202.800	-1.01E-11	2.5701E-05	-2.3690E-06	-6.3837E-12	36.3769	9.5458E-08
159782.						
219.700	-1.82E-12	-7.1219E-07	-7.6613E-07	2.9932E-13	36.3769	9.4236E-08
875533.						
236.600	2.07E-14	-2.0430E-07	2.1104E-08	5.4219E-14	36.3769	-1.0719E-09
875533.						
253.500	1.36E-14	-6.9720E-10	6.0866E-09	-6.0504E-16	36.3769	-7.0538E-10
875533.						
270.400	2.39E-16	1.4475E-09	2.1345E-11	-4.0439E-16	36.3769	-1.2398E-11
875533.						
287.300	-5.27E-17	3.7930E-11	-4.2992E-11	-7.1325E-18	36.3769	4.7846E-12
1535789.						
304.200	-1.76E-18	-5.4175E-12	-1.1275E-12	1.5627E-18	36.3769	1.6976E-13
1634263.						
321.100	1.69E-19	-2.3057E-13	1.6083E-13	5.2189E-20	36.3769	-1.7302E-14
1734362.						
338.000	8.47E-21	1.6728E-14	6.8472E-15	-5.0013E-21	36.3769	-9.2029E-16
1836160.						
354.900	-4.46E-22	1.0322E-15	-4.9641E-16	-2.5155E-22	36.3769	5.1226E-17

18 inch pipe - stratum 5 through 7.lpo

1939740.						
371.800	-3.22E-23	-4.2147E-17	-3.0637E-17	1.3232E-23	36.3769	3.8948E-18
2045190.						
388.700	9.51E-25	-3.7593E-18	1.2503E-18	9.5520E-25	36.3769	-1.2107E-19
2152606.						
405.600	1.02E-25	8.2354E-20	1.1154E-19	0.0000	36.3769	-1.3696E-20
2262088.						
422.500	0.000	1.1615E-20	-2.4425E-21	0.0000	36.3769	2.0703E-22
2373749.						
439.400	0.000	-1.0094E-22	-3.4450E-22	0.0000	36.3769	4.1261E-23
2487708.						
456.300	0.000	-3.1130E-23	2.9932E-24	0.0000	36.3769	-1.3659E-25
2604096.						
473.200	0.000	0.0000	9.2316E-25	0.0000	36.3769	-1.0839E-25
2723054.						
490.100	0.000	0.0000	0.0000	0.0000	36.3769	0.0000
2844737.						
507.000	0.000	0.0000	0.0000	0.0000	36.3769	0.0000
2969314.						
523.900	0.000	0.0000	0.0000	0.0000	36.3769	0.0000
5340698.						
540.800	0.000	0.0000	0.0000	0.0000	36.3769	0.0000
5340698.						
557.700	0.000	0.0000	0.0000	0.0000	36.3769	0.0000
5340698.						
574.600	0.000	0.0000	0.0000	0.0000	36.3769	0.0000
5340698.						
591.500	0.000	0.0000	0.0000	0.0000	36.3769	0.0000
5340698.						
608.400	0.000	0.0000	0.0000	0.0000	36.3769	0.0000
5340698.						
625.300	0.000	0.0000	0.0000	0.0000	36.3769	0.0000
6705010.						
642.200	0.000	0.0000	0.0000	0.0000	36.3769	0.0000
6705010.						
659.100	0.000	0.0000	0.0000	0.0000	36.3769	0.0000
6705010.						
676.000	0.000	0.0000	0.0000	0.0000	36.3769	0.0000
6705010.						
692.900	0.000	0.0000	0.0000	0.0000	36.3769	0.0000
6705010.						
709.800	0.000	0.0000	0.0000	0.0000	36.3769	0.0000
6705010.						
726.700	0.000	0.0000	0.0000	0.0000	36.3769	0.0000
6705010.						
743.600	0.000	0.0000	0.0000	0.0000	36.3769	0.0000
6705010.						
760.500	0.000	0.0000	0.0000	0.0000	36.3769	0.0000
6705010.						
777.400	0.000	0.0000	0.0000	0.0000	36.3769	0.0000
6705010.						
794.300	0.000	0.0000	0.0000	0.0000	36.3769	0.0000
6705010.						
811.200	0.000	0.0000	0.0000	0.0000	36.3769	0.0000
6705010.						
828.100	0.000	0.0000	0.0000	0.0000	36.3769	0.0000
5486330.						
845.000	0.000	0.0000	0.0000	0.0000	36.3769	0.0000
5486330.						
861.900	0.000	0.0000	0.0000	0.0000	36.3769	0.0000
5486330.						
878.800	0.000	0.0000	0.0000	0.0000	36.3769	0.0000
5486330.						

18 inch pipe - stratum 5 through 7.1po

895.700	0.000	0.0000	0.0000	0.0000	36.3769	0.0000
5486330.						
912.600	0.000	0.0000	0.0000	0.0000	36.3769	0.0000
5486330.						
929.500	0.000	0.0000	0.0000	0.0000	36.3769	0.0000
5486330.						
946.400	0.000	0.0000	0.0000	0.0000	36.3769	0.0000
5486330.						
963.300	0.000	0.0000	0.0000	0.0000	36.3769	0.0000
5486330.						
980.200	0.000	0.0000	0.0000	0.0000	36.3769	0.0000
5486330.						
997.100	0.000	0.0000	0.0000	0.0000	36.3769	0.0000
5486330.						
1014.	0.000	0.0000	0.0000	0.0000	36.3769	0.0000
5486330.						
1031.	0.000	0.0000	0.0000	0.0000	36.3769	0.0000
5486330.						
1048.	0.000	0.0000	0.0000	0.0000	36.3769	0.0000
5486330.						
1065.	0.000	0.0000	0.0000	0.0000	36.3769	0.0000
5486330.						
1082.	0.000	0.0000	0.0000	0.0000	36.3769	0.0000
5486330.						
1099.	0.000	0.0000	0.0000	0.0000	36.3769	0.0000
5486330.						
1115.	0.000	0.0000	0.0000	0.0000	36.3769	0.0000
5486330.						
1132.	0.000	0.0000	0.0000	0.0000	36.3769	0.0000
5486330.						
1149.	0.000	0.0000	0.0000	0.0000	36.3769	0.0000
5486330.						
1166.	0.000	0.0000	0.0000	0.0000	36.3769	0.0000
5486330.						
1183.	0.000	0.0000	0.0000	0.0000	36.3769	0.0000
5486330.						
1200.	0.000	0.0000	0.0000	0.0000	36.3769	0.0000
5486330.						
1217.	0.000	0.0000	0.0000	0.0000	36.3769	0.0000
7404154.						
1234.	0.000	0.0000	0.0000	0.0000	36.3769	0.0000
7404154.						
1251.	0.000	0.0000	0.0000	0.0000	36.3769	0.0000
7404154.						
1268.	0.000	0.0000	0.0000	0.0000	36.3769	0.0000
7404154.						
1284.	0.000	0.0000	0.0000	0.0000	36.3769	0.0000
7404154.						
1301.	0.000	0.0000	0.0000	0.0000	36.3769	0.0000
7404154.						
1318.	0.000	0.0000	0.0000	0.0000	36.3769	0.0000
7404154.						
1335.	0.000	0.0000	0.0000	0.0000	36.3769	0.0000
7404154.						
1352.	0.000	0.0000	0.0000	0.0000	36.3769	0.0000
7404154.						
1369.	0.000	0.0000	0.0000	0.0000	36.3769	0.0000
1.0911E+07						
1386.	0.000	0.0000	0.0000	0.0000	36.3769	0.0000
1.0911E+07						
1403.	0.000	0.0000	0.0000	0.0000	36.3769	0.0000
1.0911E+07						
1420.	0.000	0.0000	0.0000	0.0000	36.3769	0.0000

18 inch pipe - stratum 5 through 7.lpo

1.0911E+07						
1436.	0.000	0.0000	0.0000	0.0000	36.3769	0.0000
1.0911E+07						
1453.	0.000	0.0000	0.0000	0.0000	36.3769	0.0000
1.0911E+07						
1470.	0.000	0.0000	0.0000	0.0000	36.3769	0.0000
1.0911E+07						
1487.	0.000	0.0000	0.0000	0.0000	36.3769	0.0000
1.0911E+07						
1504.	0.000	0.0000	0.0000	0.0000	36.3769	0.0000
1.0911E+07						
1521.	0.000	0.0000	0.0000	0.0000	36.3769	0.0000
1.0911E+07						
1538.	0.000	0.0000	0.0000	0.0000	36.3769	0.0000
1.0911E+07						
1555.	0.000	0.0000	0.0000	0.0000	36.3769	0.0000
1.0911E+07						
1572.	0.000	0.0000	0.0000	0.0000	36.3769	0.0000
1.0911E+07						
1589.	0.000	0.0000	0.0000	0.0000	36.3769	0.0000
1.0911E+07						
1605.	0.000	0.0000	0.0000	0.0000	36.3769	0.0000
1.0911E+07						
1622.	0.000	0.0000	0.0000	0.0000	36.3769	0.0000
1.0911E+07						
1639.	0.000	0.0000	0.0000	0.0000	36.3769	0.0000
1.0911E+07						
1656.	0.000	0.0000	0.0000	0.0000	36.3769	0.0000
1.0911E+07						
1673.	0.000	0.0000	0.0000	0.0000	36.3769	0.0000
1.0911E+07						
1690.	0.000	0.0000	0.0000	0.0000	36.3769	0.0000
5455523.						

Output Verification:

Computed forces and moments are within specified convergence limits.

Output Summary for Load Case No. 1:

Pile-head deflection = .35401873 in
 Computed slope at pile head = -.01561454
 Maximum bending moment = 18159.36602 lbs-in
 Maximum shear force = 1000.00000 lbs
 Depth of maximum bending moment = 16.90000000 in
 Depth of maximum shear force = 0.00000 in
 Number of iterations = 13
 Number of zero deflection points = 47

 Summary of Pile Response(s)

Definition of Symbols for Pile-Head Loading Conditions:

Type 1 = Shear and Moment, y = pile-head displacment in
 Type 2 = Shear and Slope, M = Pile-head Moment lbs-in
 Type 3 = Shear and Rot. Stiffness, V = Pile-head Shear Force lbs
 Page 14

18 inch pipe - stratum 5 through 7.1po

Type 4 = Deflection and Moment,
Type 5 = Deflection and Slope,

S = Pile-head Slope, radians
R = Rot. Stiffness of Pile-head in-lbs/rad

Load Type	Pile-Head Condition 1	Pile-Head Condition 2	Axial Load lbs	Pile-Head Deflection in	Maximum Moment in-lbs	Maximum Shear lbs
1	V= 1000.000	M= 1000.000	1000.0000	.3540187	18159.3660	1000.0000

The analysis ended normally.

18 inch pipe - stratum 8 through 10.lpo

LPILE Plus for Windows, Version 5.0 (5.0.30)

Analysis of Individual Piles and Drilled Shafts
Subjected to Lateral Loading Using the p-y Method

(c) 1985-2007 by Ensoft, Inc.
All Rights Reserved

This program is licensed to:

DJI
Eustis

Path to file locations: U:\sys\WPDATA\Projects\20749\Piles\LPile\
Name of input data file: 18 inch pipe - stratum 8 through 10.lpd
Name of output file: 18 inch pipe - stratum 8 through 10.lpo
Name of plot output file: 18 inch pipe - stratum 8 through 10.lpp
Name of runtime file: 18 inch pipe - stratum 8 through 10.lpr

Time and Date of Analysis

Date: November 9, 2009 Time: 18: 5:24

Problem Title

EE20749 - St. Mary Floodgate Structure at Franklin Drainage Canal

Program Options

Units Used in Computations - US Customary Units: Inches, Pounds

Basic Program Options:

Analysis Type 1:

- Computation of Lateral Pile Response Using User-specified Constant EI

Computation Options:

- Only internally-generated p-y curves used in analysis
- Analysis does not use p-y multipliers (individual pile or shaft action only)
- Analysis assumes no shear resistance at pile tip
- Analysis for fixed-length pile or shaft only
- No computation of foundation stiffness matrix elements
- Output pile response for full length of pile
- Analysis assumes no soil movements acting on pile
- Additional p-y curves computed at specified depths

Solution Control Parameters:

- Number of pile increments = 100
- Maximum number of iterations allowed = 100

- 18 inch pipe - stratum 8 through 10.1po
- Deflection tolerance for convergence = 1.0000E-05 in
 - Maximum allowable deflection = 1.0000E+02 in

Printing Options:

- Values of pile-head deflection, bending moment, shear force, and soil reaction are printed for full length of pile.
- Printing Increment (spacing of output points) = 1

Pile Structural Properties and Geometry

Pile Length = 1690.00 in
Depth of ground surface below top of pile = .00 in
Slope angle of ground surface = .00 deg.

Structural properties of pile defined using 2 points

Point	Depth X in	Pile Diameter in	Moment of Inertia in**4	Pile Area Sq.in	Modulus of Elasticity lbs/Sq.in
1	0.0000	18.00000000	1053.2000	27.4900	30000.00000
2	1690.0000	18.00000000	1053.2000	27.4900	30000.00000

Soil and Rock Layering Information

The soil profile is modelled using 10 layers

Layer 1 is silt with cohesion and friction
Distance from top of pile to top of layer = .000 in
Distance from top of pile to bottom of layer = 36.000 in
p-y subgrade modulus k for top of soil layer = 55.600 lbs/in**3
p-y subgrade modulus k for bottom of layer = 55.600 lbs/in**3

Layer 2 is soft clay, p-y criteria by Matlock, 1970
Distance from top of pile to top of layer = 36.000 in
Distance from top of pile to bottom of layer = 180.000 in

Layer 3 is silt with cohesion and friction
Distance from top of pile to top of layer = 180.000 in
Distance from top of pile to bottom of layer = 204.000 in
p-y subgrade modulus k for top of soil layer = 55.600 lbs/in**3
p-y subgrade modulus k for bottom of layer = 55.600 lbs/in**3

Layer 4 is soft clay, p-y criteria by Matlock, 1970
Distance from top of pile to top of layer = 204.000 in
Distance from top of pile to bottom of layer = 276.000 in

Layer 5 is soft clay, p-y criteria by Matlock, 1970
Distance from top of pile to top of layer = 276.000 in
Distance from top of pile to bottom of layer = 516.000 in

Layer 6 is stiff clay without free water
Distance from top of pile to top of layer = 516.000 in
Distance from top of pile to bottom of layer = 612.000 in

Layer 7 is stiff clay without free water
Distance from top of pile to top of layer = 612.000 in

18 inch pipe - stratum 8 through 10.1po
 Distance from top of pile to bottom of layer = 828.000 in

Layer 8 is stiff clay without free water
 Distance from top of pile to top of layer = 828.000 in
 Distance from top of pile to bottom of layer = 1212.000 in

Layer 9 is stiff clay without free water
 Distance from top of pile to top of layer = 1212.000 in
 Distance from top of pile to bottom of layer = 1356.000 in

Layer 10 is stiff clay without free water
 Distance from top of pile to top of layer = 1356.000 in
 Distance from top of pile to bottom of layer = 1692.000 in

(Depth of lowest layer extends 2.00 in below pile tip)

 Effective Unit Weight of Soil vs. Depth

Distribution of effective unit weight of soil with depth
 is defined using 20 points

Point No.	Depth X in	Eff. Unit Weight lbs/in**3
1	.00	.03160
2	36.00	.03160
3	36.00	.03330
4	180.00	.03330
5	180.00	.03160
6	204.00	.03160
7	204.00	.03480
8	276.00	.03480
9	276.00	.03250
10	516.00	.03250
11	516.00	.03620
12	612.00	.03620
13	612.00	.03550
14	828.00	.03550
15	828.00	.03110
16	1212.00	.03110
17	1212.00	.03040
18	1356.00	.03040
19	1356.00	.03450
20	1692.00	.03450

 Shear Strength of Soils

Distribution of shear strength parameters with depth
 defined using 20 points

Point No.	Depth X in	Cohesion c lbs/in**2	Angle of Friction Deg.	E50 or k_rm	RQD %
1	.000	1.38890	15.00	.02000	.0
2	36.000	1.38890	15.00	.02000	.0

18 inch pipe - stratum 8 through 10.1po						
3	36.000	2.20140	.00	.02000	.0	
4	180.000	2.20140	.00	.02000	.0	
5	180.000	1.38890	15.00	.02000	.0	
6	204.000	1.38890	15.00	.02000	.0	
7	204.000	3.12500	.00	.02000	.0	
8	276.000	3.12500	.00	.02000	.0	
9	276.000	4.16670	.00	.01000	.0	
10	516.000	7.63890	.00	.00700	.0	
11	516.000	7.63890	.00	.00700	.0	
12	612.000	7.63890	.00	.00700	.0	
13	612.000	9.59030	.00	.00700	.0	
14	828.000	9.59030	.00	.00700	.0	
15	828.000	7.84720	.00	.00700	.0	
16	1212.000	7.84720	.00	.00700	.0	
17	1212.000	10.59030	.00	.00700	.0	
18	1356.000	10.59030	.00	.00700	.0	
19	1356.000	14.34720	.00	.00500	.0	
20	1692.000	14.34720	.00	.00500	.0	

Notes:

- (1) Cohesion = uniaxial compressive strength for rock materials.
- (2) Values of E50 are reported for clay strata.
- (3) Default values will be generated for E50 when input values are 0.
- (4) RQD and k_{rm} are reported only for weak rock strata.

Loading Type

Cyclic loading criteria was used for computation of p-y curves

Number of cycles of loading = 1000.

Pile-head Loading and Pile-head Fixity Conditions

Number of loads specified = 1

Load Case Number 1

Pile-head boundary conditions are Shear and Moment (BC Type 1)

Shear force at pile head = 1000.000 lbs
Bending moment at pile head = 1000.000 in-lbs
Axial load at pile head = 1000.000 lbs

Non-zero moment at pile head for this load case indicates the pile-head may rotate under the applied pile-head loading, but is not a free-head (zero moment) condition.

Output of p-y Curves at Specified Depths

18 inch pipe - stratum 8 through 10.1po

p-y curves are generated and printed for verification at 8 depths.

Depth No.	Depth Below Pile Head in	Depth Below Ground Surface in
1	840.000	840.000
2	1020.000	1020.000
3	1200.000	1200.000
4	1224.000	1224.000
5	1284.000	1284.000
6	1344.000	1344.000
7	1524.000	1524.000
8	1690.000	1690.000

Depth of ground surface below top of pile = .00 in

p-y Curve Computed Using Cyclic Criteria for Stiff Clay without Free Water

Soil Layer Number = 8
 Depth below pile head = 840.000 in
 Depth below ground surface = 840.000 in
 Equivalent Depth = 610.386 in
 Diameter = 18.000 in
 Undrained cohesion, c = 7.84720 lbs/in**2
 Average Eff. Unit Weight = .03394 lbs/in**3
 Epsilon-50 = .00700
 Pct = 3191.602 lbs/in
 Pcd = 1271.246 lbs/in
 Pu = 1271.246 lbs/in
 y50 = .315 in
 p-multiplier = 1.00000
 y-multiplier = 1.00000
 Number of cycles of loading = 1000.

y, in	p, lbs/in
0.0000	0.0000
5.0400E-05	55.2637
.0002520	82.6386
.0005040	98.2744
.0025200	146.9544
.0050400	174.7593
.0252000	261.3261
.0504000	310.7708
.1260000	390.7736
.2520000	464.7108
.3780000	514.2870
.5040000	552.6373
1.2600	694.9047
2.5200	826.3856
5.0400	982.7436
11.3400	1203.6102
17.6400	1271.2464

p-y Curve Computed Using Cyclic Criteria for Stiff Clay without Free Water

Soil Layer Number = 8
 Depth below pile head = 1020.000 in
 Depth below ground surface = 1020.000 in
 Page 5

18 inch pipe - stratum 8 through 10.lpo

Equivalent Depth = 790.386 in
 Diameter = 18.000 in
 Undrained cohesion, c = 7.84720 lbs/in**2
 Average Eff. Unit Weight = .03344 lbs/in**3
 Epsilon-50 = .00700
 Pct = 4000.689 lbs/in
 Pcd = 1271.246 lbs/in
 Pu = 1271.246 lbs/in
 y50 = .315 in
 p-multiplier = 1.00000
 y-multiplier = 1.00000
 Number of cycles of loading = 1000.

y, in	p, lbs/in
0.0000	0.0000
5.0400E-05	55.2637
.0002520	82.6386
.0005040	98.2744
.0025200	146.9544
.0050400	174.7593
.0252000	261.3261
.0504000	310.7708
.1260000	390.7736
.2520000	464.7108
.3780000	514.2870
.5040000	552.6373
1.2600	694.9047
2.5200	826.3856
5.0400	982.7436
11.3400	1203.6102
17.6400	1271.2464

p-y Curve Computed Using Cyclic Criteria for Stiff Clay without Free Water

Soil Layer Number = 8
 Depth below pile head = 1200.000 in
 Depth below ground surface = 1200.000 in
 Equivalent Depth = 970.386 in
 Diameter = 18.000 in
 Undrained cohesion, c = 7.84720 lbs/in**2
 Average Eff. Unit Weight = .03309 lbs/in**3
 Epsilon-50 = .00700
 Pct = 4809.153 lbs/in
 Pcd = 1271.246 lbs/in
 Pu = 1271.246 lbs/in
 y50 = .315 in
 p-multiplier = 1.00000
 y-multiplier = 1.00000
 Number of cycles of loading = 1000.

y, in	p, lbs/in
0.0000	0.0000
5.0400E-05	55.2637
.0002520	82.6386
.0005040	98.2744
.0025200	146.9544
.0050400	174.7593
.0252000	261.3261
.0504000	310.7708
.1260000	390.7736

18 inch pipe - stratum 8 through 10.lpo

.2520000	464.7108
.3780000	514.2870
.5040000	552.6373
1.2600	694.9047
2.5200	826.3856
5.0400	982.7436
11.3400	1203.6102
17.6400	1271.2464

p-y Curve Computed Using Cyclic Criteria for Stiff Clay without Free Water

Soil Layer Number = 9
 Depth below pile head = 1224.000 in
 Depth below ground surface = 1224.000 in
 Equivalent Depth = 758.425 in
 Diameter = 18.000 in
 Undrained cohesion, c = 10.59030 lbs/in**2
 Average Eff. Unit Weight = .03305 lbs/in**3
 Epsilon-50 = .00700
 Pct = 5038.972 lbs/in
 Pcd = 1715.629 lbs/in
 Pu = 1715.629 lbs/in
 y50 = .315 in
 p-multiplier = 1.00000
 y-multiplier = 1.00000
 Number of cycles of loading = 1000.

y, in	p, lbs/in
0.0000	0.0000
5.0400E-05	74.5820
.0002520	111.5260
.0005040	132.6276
.0025200	198.3245
.0050400	235.8489
.0252000	352.6763
.0504000	419.4052
.1260000	527.3741
.2520000	627.1570
.3780000	694.0633
.5040000	745.8196
1.2600	937.8184
2.5200	1115.2604
5.0400	1326.2756
11.3400	1624.3492
17.6400	1715.6286

p-y Curve Computed Using Cyclic Criteria for Stiff Clay without Free Water

Soil Layer Number = 9
 Depth below pile head = 1284.000 in
 Depth below ground surface = 1284.000 in
 Equivalent Depth = 818.425 in
 Diameter = 18.000 in
 Undrained cohesion, c = 10.59030 lbs/in**2
 Average Eff. Unit Weight = .03292 lbs/in**3
 Epsilon-50 = .00700
 Pct = 5390.549 lbs/in

18 inch pipe - stratum 8 through 10.lpo

Pcd = 1715.629 lbs/in
 Pu = 1715.629 lbs/in
 y50 = .315 in
 p-multiplier = 1.00000
 y-multiplier = 1.00000
 Number of cycles of loading = 1000.

y, in	p, lbs/in
0.0000	0.0000
5.0400E-05	74.5820
.0002520	111.5260
.0005040	132.6276
.0025200	198.3245
.0050400	235.8489
.0252000	352.6763
.0504000	419.4052
.1260000	527.3741
.2520000	627.1570
.3780000	694.0633
.5040000	745.8196
1.2600	937.8184
2.5200	1115.2604
5.0400	1326.2756
11.3400	1624.3492
17.6400	1715.6286

p-y Curve Computed Using Cyclic Criteria for Stiff Clay without Free Water

Soil Layer Number = 9
 Depth below pile head = 1344.000 in
 Depth below ground surface = 1344.000 in
 Equivalent Depth = 878.425 in
 Diameter = 18.000 in
 Undrained cohesion, c = 10.59030 lbs/in**2
 Average Eff. Unit Weight = .03281 lbs/in**3
 Epsilon-50 = .00700
 Pct = 5742.033 lbs/in
 Pcd = 1715.629 lbs/in
 Pu = 1715.629 lbs/in
 y50 = .315 in
 p-multiplier = 1.00000
 y-multiplier = 1.00000
 Number of cycles of loading = 1000.

y, in	p, lbs/in
0.0000	0.0000
5.0400E-05	74.5820
.0002520	111.5260
.0005040	132.6276
.0025200	198.3245
.0050400	235.8489
.0252000	352.6763
.0504000	419.4052
.1260000	527.3741
.2520000	627.1570
.3780000	694.0633
.5040000	745.8196
1.2600	937.8184
2.5200	1115.2604
5.0400	1326.2756

11.3400 18 inch pipe - stratum 8 through 10.lpo
 17.6400 1624.3492
 1715.6286

p-y Curve Computed Using Cyclic Criteria for Stiff Clay without Free Water

Soil Layer Number = 10
 Depth below pile head = 1524.000 in
 Depth below ground surface = 1524.000 in
 Equivalent Depth = 840.466 in
 Diameter = 18.000 in
 Undrained cohesion, c = 14.34720 lbs/in**2
 Average Eff. Unit Weight = .03298 lbs/in**3
 Epsilon-50 = .00500
 Pct = 7302.798 lbs/in
 Pcd = 2324.246 lbs/in
 Pu = 2324.246 lbs/in
 y50 = .225 in
 p-multiplier = 1.00000
 y-multiplier = 1.00000
 Number of cycles of loading = 1000.

y, in	p, lbs/in
0.0000	0.0000
3.6000E-05	101.0398
.0001800	151.0898
.0003600	179.6771
.0018000	268.6799
.0036000	319.5160
.0180000	477.7879
.0360000	568.1888
.0900000	714.4596
.1800000	849.6404
.2700000	940.2817
.3600000	1010.3984
.9000000	1270.5087
1.8000	1510.8980
3.6000	1796.7707
8.1000	2200.5857
12.6000	2324.2464

p-y Curve Computed Using Cyclic Criteria for Stiff Clay without Free Water

Soil Layer Number = 10
 Depth below pile head = 1690.000 in
 Depth below ground surface = 1690.000 in
 Equivalent Depth = 1006.466 in
 Diameter = 18.000 in
 Undrained cohesion, c = 14.34720 lbs/in**2
 Average Eff. Unit Weight = .03313 lbs/in**3
 Epsilon-50 = .00500
 Pct = 8594.860 lbs/in
 Pcd = 2324.246 lbs/in
 Pu = 2324.246 lbs/in
 y50 = .225 in
 p-multiplier = 1.00000
 y-multiplier = 1.00000
 Number of cycles of loading = 1000.

18 inch pipe - stratum 8 through 10.lpo

y, in	p, lbs/in
0.0000	0.0000
3.6000E-05	101.0398
.0001800	151.0898
.0003600	179.6771
.0018000	268.6799
.0036000	319.5160
.0180000	477.7879
.0360000	568.1888
.0900000	714.4596
.1800000	849.6404
.2700000	940.2817
.3600000	1010.3984
.9000000	1270.5087
1.8000	1510.8980
3.6000	1796.7707
8.1000	2200.5857
12.6000	2324.2464

 Computed Values of Load Distribution and Deflection
 for Lateral Loading for Load Case Number 1

Pile-head boundary conditions are Shear and Moment (BC Type 1)
 Specified shear force at pile head = 1000.000 lbs
 Specified moment at pile head = 1000.000 in-lbs
 Specified axial load at pile head = 1000.000 lbs

Non-zero moment for this load case indicates the pile-head may rotate under the applied pile-head loading, but is not a free-head (zero moment) condition.

Depth Es*h X F/L in lbs/in	Deflect. y in	Moment M lbs-in	Shear V lbs	Slope S Rad.	Total Stress lbs/in**2	Soil Res. p lbs/in
0.000	.354019	1000.0000	1000.0000	-.0156145	44.9222	0.0000
0.0000						
16.900	.094653	18159.3660	248.4614	-.0104906	191.5556	-88.9395
15879.9160						
33.800	-.000563	9752.5782	-494.1384	-.0030258	119.7164	1.0578
31759.8320						
50.700	-.007621	1559.7602	-309.4562	-4.8097E-07	49.7056	20.7981
46122.7088						
67.600	-.000579	-707.0240	-48.2473	.0002276	42.4187	10.1142
295141.						
84.500	7.13E-05	-78.6901	21.0993	1.7443E-05	37.0493	-1.9075
452134.						
101.400	1.04E-05	5.5417	2.3619	-2.1194E-06	36.4242	-.3098926
501824.						
118.300	-3.34E-07	1.2151	-.1645787	-3.1233E-07	36.3872	.0108963
551514.						
135.200	-1.20E-07	-.0104613	-.0363204	9.8366E-09	36.3770	.0042822

18 inch pipe - stratum 8 through 10.lpo

601204.						
152.100	-1.42E-09	-.0128751	.0003016	3.5955E-09	36.3770	5.1763E-05
616768.						
169.000	1.15E-09	-.0003884	.0003833	4.8293E-11	36.3769	-4.2095E-05
616768.						
185.900	2.14E-10	7.9146E-05	1.2218E-05	-3.4424E-11	36.3769	-1.8218E-06
143902.						
202.800	-1.01E-11	2.5701E-05	-2.3690E-06	-6.3837E-12	36.3769	9.5458E-08
159782.						
219.700	-1.82E-12	-7.1219E-07	-7.6613E-07	2.9932E-13	36.3769	9.4236E-08
875533.						
236.600	2.07E-14	-2.0430E-07	2.1104E-08	5.4219E-14	36.3769	-1.0719E-09
875533.						
253.500	1.36E-14	-6.9720E-10	6.0866E-09	-6.0504E-16	36.3769	-7.0538E-10
875533.						
270.400	2.39E-16	1.4475E-09	2.1345E-11	-4.0439E-16	36.3769	-1.2398E-11
875533.						
287.300	-5.27E-17	3.7930E-11	-4.2992E-11	-7.1325E-18	36.3769	4.7846E-12
1535789.						
304.200	-1.76E-18	-5.4175E-12	-1.1275E-12	1.5627E-18	36.3769	1.6976E-13
1634263.						
321.100	1.69E-19	-2.3057E-13	1.6083E-13	5.2189E-20	36.3769	-1.7302E-14
1734362.						
338.000	8.47E-21	1.6728E-14	6.8472E-15	-5.0013E-21	36.3769	-9.2029E-16
1836160.						
354.900	-4.46E-22	1.0322E-15	-4.9641E-16	-2.5155E-22	36.3769	5.1226E-17
1939740.						
371.800	-3.22E-23	-4.2147E-17	-3.0637E-17	1.3232E-23	36.3769	3.8948E-18
2045190.						
388.700	9.51E-25	-3.7593E-18	1.2503E-18	9.5520E-25	36.3769	-1.2107E-19
2152606.						
405.600	1.02E-25	8.2354E-20	1.1154E-19	0.0000	36.3769	-1.3696E-20
2262088.						
422.500	0.000	1.1615E-20	-2.4425E-21	0.0000	36.3769	2.0703E-22
2373749.						
439.400	0.000	-1.0094E-22	-3.4450E-22	0.0000	36.3769	4.1261E-23
2487708.						
456.300	0.000	-3.1130E-23	2.9932E-24	0.0000	36.3769	-1.3659E-25
2604096.						
473.200	0.000	0.0000	9.2316E-25	0.0000	36.3769	-1.0839E-25
2723054.						
490.100	0.000	0.0000	0.0000	0.0000	36.3769	0.0000
2844737.						
507.000	0.000	0.0000	0.0000	0.0000	36.3769	0.0000
2969314.						
523.900	0.000	0.0000	0.0000	0.0000	36.3769	0.0000
5340698.						
540.800	0.000	0.0000	0.0000	0.0000	36.3769	0.0000
5340698.						
557.700	0.000	0.0000	0.0000	0.0000	36.3769	0.0000
5340698.						
574.600	0.000	0.0000	0.0000	0.0000	36.3769	0.0000
5340698.						
591.500	0.000	0.0000	0.0000	0.0000	36.3769	0.0000
5340698.						
608.400	0.000	0.0000	0.0000	0.0000	36.3769	0.0000
5340698.						
625.300	0.000	0.0000	0.0000	0.0000	36.3769	0.0000
6705010.						
642.200	0.000	0.0000	0.0000	0.0000	36.3769	0.0000
6705010.						
659.100	0.000	0.0000	0.0000	0.0000	36.3769	0.0000
6705010.						

18 inch pipe - stratum 8 through 10.1po

676.000	0.000	0.0000	0.0000	0.0000	36.3769	0.0000
6705010.						
692.900	0.000	0.0000	0.0000	0.0000	36.3769	0.0000
6705010.						
709.800	0.000	0.0000	0.0000	0.0000	36.3769	0.0000
6705010.						
726.700	0.000	0.0000	0.0000	0.0000	36.3769	0.0000
6705010.						
743.600	0.000	0.0000	0.0000	0.0000	36.3769	0.0000
6705010.						
760.500	0.000	0.0000	0.0000	0.0000	36.3769	0.0000
6705010.						
777.400	0.000	0.0000	0.0000	0.0000	36.3769	0.0000
6705010.						
794.300	0.000	0.0000	0.0000	0.0000	36.3769	0.0000
6705010.						
811.200	0.000	0.0000	0.0000	0.0000	36.3769	0.0000
6705010.						
828.100	0.000	0.0000	0.0000	0.0000	36.3769	0.0000
5486330.						
845.000	0.000	0.0000	0.0000	0.0000	36.3769	0.0000
5486330.						
861.900	0.000	0.0000	0.0000	0.0000	36.3769	0.0000
5486330.						
878.800	0.000	0.0000	0.0000	0.0000	36.3769	0.0000
5486330.						
895.700	0.000	0.0000	0.0000	0.0000	36.3769	0.0000
5486330.						
912.600	0.000	0.0000	0.0000	0.0000	36.3769	0.0000
5486330.						
929.500	0.000	0.0000	0.0000	0.0000	36.3769	0.0000
5486330.						
946.400	0.000	0.0000	0.0000	0.0000	36.3769	0.0000
5486330.						
963.300	0.000	0.0000	0.0000	0.0000	36.3769	0.0000
5486330.						
980.200	0.000	0.0000	0.0000	0.0000	36.3769	0.0000
5486330.						
997.100	0.000	0.0000	0.0000	0.0000	36.3769	0.0000
5486330.						
1014.	0.000	0.0000	0.0000	0.0000	36.3769	0.0000
5486330.						
1031.	0.000	0.0000	0.0000	0.0000	36.3769	0.0000
5486330.						
1048.	0.000	0.0000	0.0000	0.0000	36.3769	0.0000
5486330.						
1065.	0.000	0.0000	0.0000	0.0000	36.3769	0.0000
5486330.						
1082.	0.000	0.0000	0.0000	0.0000	36.3769	0.0000
5486330.						
1099.	0.000	0.0000	0.0000	0.0000	36.3769	0.0000
5486330.						
1115.	0.000	0.0000	0.0000	0.0000	36.3769	0.0000
5486330.						
1132.	0.000	0.0000	0.0000	0.0000	36.3769	0.0000
5486330.						
1149.	0.000	0.0000	0.0000	0.0000	36.3769	0.0000
5486330.						
1166.	0.000	0.0000	0.0000	0.0000	36.3769	0.0000
5486330.						
1183.	0.000	0.0000	0.0000	0.0000	36.3769	0.0000
5486330.						
1200.	0.000	0.0000	0.0000	0.0000	36.3769	0.0000

18 inch pipe - stratum 8 through 10.lpo

5486330.						
1217.	0.000	0.0000	0.0000	0.0000	36.3769	0.0000
7404154.						
1234.	0.000	0.0000	0.0000	0.0000	36.3769	0.0000
7404154.						
1251.	0.000	0.0000	0.0000	0.0000	36.3769	0.0000
7404154.						
1268.	0.000	0.0000	0.0000	0.0000	36.3769	0.0000
7404154.						
1284.	0.000	0.0000	0.0000	0.0000	36.3769	0.0000
7404154.						
1301.	0.000	0.0000	0.0000	0.0000	36.3769	0.0000
7404154.						
1318.	0.000	0.0000	0.0000	0.0000	36.3769	0.0000
7404154.						
1335.	0.000	0.0000	0.0000	0.0000	36.3769	0.0000
7404154.						
1352.	0.000	0.0000	0.0000	0.0000	36.3769	0.0000
7404154.						
1369.	0.000	0.0000	0.0000	0.0000	36.3769	0.0000
1.0911E+07						
1386.	0.000	0.0000	0.0000	0.0000	36.3769	0.0000
1.0911E+07						
1403.	0.000	0.0000	0.0000	0.0000	36.3769	0.0000
1.0911E+07						
1420.	0.000	0.0000	0.0000	0.0000	36.3769	0.0000
1.0911E+07						
1436.	0.000	0.0000	0.0000	0.0000	36.3769	0.0000
1.0911E+07						
1453.	0.000	0.0000	0.0000	0.0000	36.3769	0.0000
1.0911E+07						
1470.	0.000	0.0000	0.0000	0.0000	36.3769	0.0000
1.0911E+07						
1487.	0.000	0.0000	0.0000	0.0000	36.3769	0.0000
1.0911E+07						
1504.	0.000	0.0000	0.0000	0.0000	36.3769	0.0000
1.0911E+07						
1521.	0.000	0.0000	0.0000	0.0000	36.3769	0.0000
1.0911E+07						
1538.	0.000	0.0000	0.0000	0.0000	36.3769	0.0000
1.0911E+07						
1555.	0.000	0.0000	0.0000	0.0000	36.3769	0.0000
1.0911E+07						
1572.	0.000	0.0000	0.0000	0.0000	36.3769	0.0000
1.0911E+07						
1589.	0.000	0.0000	0.0000	0.0000	36.3769	0.0000
1.0911E+07						
1605.	0.000	0.0000	0.0000	0.0000	36.3769	0.0000
1.0911E+07						
1622.	0.000	0.0000	0.0000	0.0000	36.3769	0.0000
1.0911E+07						
1639.	0.000	0.0000	0.0000	0.0000	36.3769	0.0000
1.0911E+07						
1656.	0.000	0.0000	0.0000	0.0000	36.3769	0.0000
1.0911E+07						
1673.	0.000	0.0000	0.0000	0.0000	36.3769	0.0000
1.0911E+07						
1690.	0.000	0.0000	0.0000	0.0000	36.3769	0.0000
5455523.						

Output Verification:

Computed forces and moments are within specified convergence limits.

18 inch pipe - stratum 8 through 10.7po

Output Summary for Load Case No. 1:

Pile-head deflection = .35401873 in
 Computed slope at pile head = -.01561454
 Maximum bending moment = 18159.36602 lbs-in
 Maximum shear force = 1000.00000 lbs
 Depth of maximum bending moment = 16.90000000 in
 Depth of maximum shear force = 0.00000 in
 Number of iterations = 13
 Number of zero deflection points = 47

 Summary of Pile Response(s)

Definition of Symbols for Pile-Head Loading Conditions:

Type 1 = Shear and Moment, y = pile-head displacement in
 Type 2 = Shear and Slope, M = Pile-head Moment lbs-in
 Type 3 = Shear and Rot. Stiffness, V = Pile-head Shear Force lbs
 Type 4 = Deflection and Moment, S = Pile-head Slope, radians
 Type 5 = Deflection and Slope, R = Rot. Stiffness of Pile-head in-lbs/rad

Load Type	Pile-Head Condition 1	Pile-Head Condition 2	Axial Load lbs	Pile-Head Deflection in	Maximum Moment in-lbs	Maximum Shear lbs
1	V= 1000.000	M= 1000.000	1000.0000	.3540187	18159.3660	1000.0000

The analysis ended normally.

24 inch pipe - stratum 1 through 4.lpo

LPILE Plus for Windows, Version 5.0 (5.0.30)

Analysis of Individual Piles and Drilled Shafts
Subjected to Lateral Loading Using the p-y Method

(c) 1985-2007 by Ensoft, Inc.
All Rights Reserved

This program is licensed to:

DJI
Eustis

Path to file locations: U:\sys\WPDATA\Projects\20749\Piles\LPile\
Name of input data file: 24 inch pipe - stratum 1 through 4.lpd
Name of output file: 24 inch pipe - stratum 1 through 4.lpo
Name of plot output file: 24 inch pipe - stratum 1 through 4.lpp
Name of runtime file: 24 inch pipe - stratum 1 through 4.lpr

Time and Date of Analysis

Date: November 9, 2009 Time: 17:47: 6

Problem Title

EE20749 - St. Mary Floodgate Structure at Franklin Drainage Canal

Program Options

Units Used in Computations - US Customary Units: Inches, Pounds

Basic Program Options:

Analysis Type 1:

- Computation of Lateral Pile Response Using User-specified Constant EI

Computation Options:

- Only internally-generated p-y curves used in analysis
- Analysis does not use p-y multipliers (individual pile or shaft action only)
- Analysis assumes no shear resistance at pile tip
- Analysis for fixed-length pile or shaft only
- No computation of foundation stiffness matrix elements
- Output pile response for full length of pile
- Analysis assumes no soil movements acting on pile
- Additional p-y curves computed at specified depths

Solution Control Parameters:

- Number of pile increments = 100
- Maximum number of iterations allowed = 100

24 inch pipe - stratum 1 through 4.1po

- Deflection tolerance for convergence = 1.0000E-05 in
- Maximum allowable deflection = 1.0000E+02 in

Printing Options:

- Values of pile-head deflection, bending moment, shear force, and soil reaction are printed for full length of pile.
- Printing Increment (spacing of output points) = 1

Pile Structural Properties and Geometry

Pile Length = 1690.00 in
Depth of ground surface below top of pile = .00 in
Slope angle of ground surface = .00 deg.

Structural properties of pile defined using 2 points

Point	Depth X in	Pile Diameter in	Moment of Inertia in**4	Pile Area Sq.in	Modulus of Elasticity lbs/Sq.in
1	0.0000	24.00000000	2549.4000	36.9100	30000.00000
2	1690.0000	24.00000000	2549.4000	36.9100	30000.00000

Soil and Rock Layering Information

The soil profile is modelled using 10 layers

Layer 1 is silt with cohesion and friction
Distance from top of pile to top of layer = .000 in
Distance from top of pile to bottom of layer = 36.000 in
p-y subgrade modulus k for top of soil layer = 55.600 lbs/in**3
p-y subgrade modulus k for bottom of layer = 55.600 lbs/in**3

Layer 2 is soft clay, p-y criteria by Matlock, 1970
Distance from top of pile to top of layer = 36.000 in
Distance from top of pile to bottom of layer = 180.000 in

Layer 3 is silt with cohesion and friction
Distance from top of pile to top of layer = 180.000 in
Distance from top of pile to bottom of layer = 204.000 in
p-y subgrade modulus k for top of soil layer = 55.600 lbs/in**3
p-y subgrade modulus k for bottom of layer = 55.600 lbs/in**3

Layer 4 is soft clay, p-y criteria by Matlock, 1970
Distance from top of pile to top of layer = 204.000 in
Distance from top of pile to bottom of layer = 276.000 in

Layer 5 is soft clay, p-y criteria by Matlock, 1970
Distance from top of pile to top of layer = 276.000 in
Distance from top of pile to bottom of layer = 516.000 in

Layer 6 is stiff clay without free water
Distance from top of pile to top of layer = 516.000 in
Distance from top of pile to bottom of layer = 612.000 in

Layer 7 is stiff clay without free water
Distance from top of pile to top of layer = 612.000 in

24 inch pipe - stratum 1 through 4.1po
 Distance from top of pile to bottom of layer = 828.000 in

Layer 8 is stiff clay without free water
 Distance from top of pile to top of layer = 828.000 in
 Distance from top of pile to bottom of layer = 1212.000 in

Layer 9 is stiff clay without free water
 Distance from top of pile to top of layer = 1212.000 in
 Distance from top of pile to bottom of layer = 1356.000 in

Layer 10 is stiff clay without free water
 Distance from top of pile to top of layer = 1356.000 in
 Distance from top of pile to bottom of layer = 1692.000 in

(Depth of lowest layer extends 2.00 in below pile tip)

 Effective Unit Weight of Soil vs. Depth

Distribution of effective unit weight of soil with depth
 is defined using 20 points

Point No.	Depth X in	Eff. Unit Weight lbs/in**3
1	.00	.03160
2	36.00	.03160
3	36.00	.03330
4	180.00	.03330
5	180.00	.03160
6	204.00	.03160
7	204.00	.03480
8	276.00	.03480
9	276.00	.03250
10	516.00	.03250
11	516.00	.03620
12	612.00	.03620
13	612.00	.03550
14	828.00	.03550
15	828.00	.03110
16	1212.00	.03110
17	1212.00	.03040
18	1356.00	.03040
19	1356.00	.03450
20	1692.00	.03450

 Shear strength of soils

Distribution of shear strength parameters with depth
 defined using 20 points

Point No.	Depth X in	Cohesion c lbs/in**2	Angle of Friction Deg.	E50 or k_rm	RQD %
1	.000	1.38890	15.00	.02000	.0
2	36.000	1.38890	15.00	.02000	.0

24 inch pipe - stratum 1 through 4.1po					
3	36.000	2.20140	.00	.02000	.0
4	180.000	2.20140	.00	.02000	.0
5	180.000	1.38890	15.00	.02000	.0
6	204.000	1.38890	15.00	.02000	.0
7	204.000	3.12500	.00	.02000	.0
8	276.000	3.12500	.00	.02000	.0
9	276.000	4.16670	.00	.01000	.0
10	516.000	7.63890	.00	.00700	.0
11	516.000	7.63890	.00	.00700	.0
12	612.000	7.63890	.00	.00700	.0
13	612.000	9.59030	.00	.00700	.0
14	828.000	9.59030	.00	.00700	.0
15	828.000	7.84720	.00	.00700	.0
16	1212.000	7.84720	.00	.00700	.0
17	1212.000	10.59030	.00	.00700	.0
18	1356.000	10.59030	.00	.00700	.0
19	1356.000	14.34720	.00	.00500	.0
20	1692.000	14.34720	.00	.00500	.0

Notes:

- (1) Cohesion = uniaxial compressive strength for rock materials.
- (2) Values of E50 are reported for clay strata.
- (3) Default values will be generated for E50 when input values are 0.
- (4) RQD and k_{rm} are reported only for weak rock strata.

Loading Type

Cyclic loading criteria was used for computation of p-y curves

Number of cycles of loading = 1000.

Pile-head Loading and Pile-head Fixity Conditions

Number of loads specified = 1

Load Case Number 1

Pile-head boundary conditions are Shear and Moment (BC Type 1)

Shear force at pile head = 1000.000 lbs
 Bending moment at pile head = 1000.000 in-lbs
 Axial load at pile head = 1000.000 lbs

Non-zero moment at pile head for this load case indicates the pile-head may rotate under the applied pile-head loading, but is not a free-head (zero moment) condition.

Output of p-y Curves at Specified Depths

24 inch pipe - stratum 1 through 4.1po

p-y curves are generated and printed for verification at 8 depths.

Depth No.	Depth Below Pile Head in	Depth Below Ground Surface in
1	18.000	18.000
2	48.000	48.000
3	108.000	108.000
4	168.000	168.000
5	192.000	192.000
6	216.000	216.000
7	240.000	240.000
8	264.000	264.000

Depth of ground surface below top of pile = .00 in

Eq. 3.65	19.7072
Eq. 3.66	63.0615
Eq. 3.67	3.7845
Eq. 3.67	126.1521
Eq. 3.69	145.8593
Eq. 3.75	-3.7500
Eq. 3.76	171.3594
Eq. 3.77	.2483

p-y Curve Computed Using the Cyclic Criteria for Cemented Silt

Soil Layer Number	=	1
Depth below pile head	=	18.000 in
Depth below ground surface	=	18.000in
Equivalent Depth	=	18.000in
Pile Diameter	=	24.000in
Cohesion, c	=	1.389lbs/in**2
Angle of Friction	=	15.000 deg.
Avg. Eff. Unit Weight	=	.03160lbs/in**3
k (internal default)	=	55.600lbs/in**3
E50 (internal default)	=	.02000
A parameter	=	1.00000
B parameter	=	.77500
Pu	=	126.152lbs/in
Pc	=	19.707lbs/in
Number of Cycles of Loading	=	1000.
p-multiplier	=	1.00000
y-multiplier	=	1.00000
Pu,c	=	126.152lbs/in
Pc,phi	=	19.707lbs/in

y, in	p, lbs/in
0.0000	0.0000
.0333333	33.3600
.0666667	66.7200
.1000000	100.0800
.1333333	133.4400
.1666667	166.8000
.2000000	200.1600
.2333333	233.5200
.2666667	243.7715
.3000000	236.2340
.3333333	229.6891
.3666667	223.9248

	24 inch pipe - stratum 1 through 4.lpo
.4000000	218.7889
.9000000	145.8593
24.9000	145.8593
48.9000	145.8593
72.9000	145.8593

p-y Curve Computed Using the Soft Clay Criteria for Cyclic Loading Conditions

Soil Layer Number	=	2
Depth below pile head	=	48.000 in
Depth below ground surface	=	48.000 in
Equivalent Depth	=	40.915 in
Pile Diameter	=	24.000 in
Cohesion, c	=	2.201 lbs/in**2
Avg Eff Unit Weight	=	.03203 lbs/in**3
E50 parameter	=	.02000
Default J parameter	=	.500
Y50	=	1.20000 in
p-multiplier	=	1.00000
y-multiplier	=	1.00000
Number of cycles of loading	=	1000.
Xr	=	169.583 in

y, in	p, lbs/in
0.0000	0.0000
.0096000	24.8227
.3000000	78.1867
.6000000	98.5090
.9000000	112.7647
1.2000	124.1136
1.5000	133.6973
1.8000	142.0746
2.1000	149.5657
2.4000	156.3733
2.7000	162.6348
3.0000	168.4481
3.3000	173.8856
3.6000	179.0028
9.6000	122.2221
18.0000	43.1200
24.0000	43.1200

p-y Curve Computed Using the Soft Clay Criteria for Cyclic Loading Conditions

Soil Layer Number	=	2
Depth below pile head	=	108.000 in
Depth below ground surface	=	108.000 in
Equivalent Depth	=	100.915 in
Pile Diameter	=	24.000 in
Cohesion, c	=	2.201 lbs/in**2
Avg Eff Unit Weight	=	.03273 lbs/in**3
E50 parameter	=	.02000
Default J parameter	=	.500
Y50	=	1.20000 in
p-multiplier	=	1.00000
y-multiplier	=	1.00000
Number of cycles of loading	=	1000.

Xr 24 inch pipe - stratum 1 through 4.1po
 = 168.055 in

y, in	p, lbs/in
0.0000	0.0000
.0096000	36.2221
.3000000	114.0925
.6000000	143.7476
.9000000	164.5499
1.2000	181.1106
1.5000	195.0955
1.8000	207.3199
2.1000	218.2512
2.4000	228.1851
2.7000	237.3220
3.0000	245.8049
3.3000	253.7395
3.6000	261.2067
9.6000	217.3857
18.0000	156.6067
24.0000	156.6067

p-y Curve Computed Using the Soft Clay Criteria for Cyclic Loading Conditions

Soil Layer Number = 2
 Depth below pile head = 168.000 in
 Depth below ground surface = 168.000 in
 Equivalent Depth = 160.915 in
 Pile Diameter = 24.000 in
 Cohesion, c = 2.201 lbs/in**2
 Avg Eff Unit Weight = .03294 lbs/in**3
 E50 parameter = .02000
 Default J parameter = .500
 Y50 = 1.20000 in
 p-multiplier = 1.00000
 y-multiplier = 1.00000
 Number of cycles of loading = 1000.
 Xr = 167.623 in

y, in	p, lbs/in
0.0000	0.0000
.0096000	47.5502
.3000000	149.7739
.6000000	188.7033
.9000000	216.0113
1.2000	237.7512
1.5000	256.1097
1.8000	272.1572
2.1000	286.5071
2.4000	299.5477
2.7000	311.5422
3.0000	322.6780
3.3000	333.0941
3.6000	342.8966
9.6000	336.6528
18.0000	328.6602
24.0000	328.6602

24 inch pipe - stratum 1 through 4.1po

Eq. 3.66 699.7964
 Eq. 3.67 10.6652
 Eq. 3.68 300.0024
 Eq. 3.69 814.9250
 Eq. 3.75 -3.2365
 Eq. 3.76 1000.3467
 Eq. 3.77 .1780

p-y Curve Computed Using the Cyclic Criteria for Cemented Silt

Soil Layer Number = 3
 Depth below pile head = 192.000 in
 Depth below ground surface = 192.000in
 Equivalent Depth = 172.239in
 Pile Diameter = 24.000in
 Cohesion, c = 1.389lbs/in**2
 Angle of Friction = 15.000 deg.
 Avg. Eff. Unit Weight = .03288lbs/in**3
 k (internal default) = 55.600lbs/in**3
 E50 (internal default) = .02000
 A parameter = .88000
 B parameter = .55000
 Pu = 300.002lbs/in
 Pc = 585.139lbs/in
 Number of Cycles of Loading = 1000.
 p-multiplier = 1.00000
 y-multiplier = 1.00000
 Pu,c = 300.002lbs/in
 Pc,phi = 585.139lbs/in

y, in	p, lbs/in
0.0000	0.0000
.0333333	319.2168
.0666667	638.4336
.1000000	957.6504
.1333333	1276.8672
.1666667	1596.0840
.2000000	1644.8066
.2333333	1568.3030
.2666667	1504.9147
.3000000	1451.1324
.3333333	1404.6532
.3666667	1363.8915
.4000000	1327.7126
.9000000	814.9250
24.9000	814.9250
48.9000	814.9250
72.9000	814.9250

p-y Curve Computed Using the Soft Clay Criteria for Cyclic Loading Conditions

Soil Layer Number = 4
 Depth below pile head = 216.000 in
 Depth below ground surface = 216.000 in
 Equivalent Depth = 293.038 in
 Pile Diameter = 24.000 in
 Cohesion, c = 3.125 lbs/in**2

24 inch pipe - stratum 1 through 4.1po

Avg Eff Unit Weight = .03291 lbs/in**3
 E50 parameter = .02000
 Default J parameter = .500
 Y50 = 1.20000 in
 p-multiplier = 1.00000
 y-multiplier = 1.00000
 Number of cycles of loading = 1000.
 Xr = 191.297 in

y, in	p, lbs/in
0.0000	0.0000
.0096000	67.5000
.3000000	212.6117
.6000000	267.8739
.9000000	306.6391
1.2000	337.5000
1.5000	363.5609
1.8000	386.3411
2.1000	406.7115
2.4000	425.2234
2.7000	442.2501
3.0000	458.0580
3.3000	472.8441
3.6000	486.7592
9.6000	486.0000
18.0000	486.0000
24.0000	486.0000

p-y Curve Computed Using the Soft Clay Criteria for Cyclic Loading Conditions

Soil Layer Number = 4
 Depth below pile head = 240.000 in
 Depth below ground surface = 240.000 in
 Equivalent Depth = 317.038 in
 Pile Diameter = 24.000 in
 Cohesion, c = 3.125 lbs/in**2
 Avg Eff Unit Weight = .03310 lbs/in**3
 E50 parameter = .02000
 Default J parameter = .500
 Y50 = 1.20000 in
 p-multiplier = 1.00000
 y-multiplier = 1.00000
 Number of cycles of loading = 1000.
 Xr = 190.929 in

y, in	p, lbs/in
0.0000	0.0000
.0096000	67.5000
.3000000	212.6117
.6000000	267.8739
.9000000	306.6391
1.2000	337.5000
1.5000	363.5609
1.8000	386.3411
2.1000	406.7115
2.4000	425.2234
2.7000	442.2501
3.0000	458.0580
3.3000	472.8441
3.6000	486.7592

	24 inch pipe - stratum 1 through 4.1po
9.6000	486.0000
18.0000	486.0000
24.0000	486.0000

p-y Curve Computed Using the Soft Clay Criteria for Cyclic Loading Conditions

Soil Layer Number	=	4
Depth below pile head	=	264.000 in
Depth below ground surface	=	264.000 in
Equivalent Depth	=	341.038 in
Pile Diameter	=	24.000 in
Cohesion, c	=	3.125 lbs/in**2
Avg Eff Unit Weight	=	.03325 lbs/in**3
E50 parameter	=	.02000
Default J parameter	=	.500
Y50	=	1.20000 in
p-multiplier	=	1.00000
y-multiplier	=	1.00000
Number of cycles of loading	=	1000.
Xr	=	190.629 in

y, in	p, lbs/in
0.0000	0.0000
.0096000	67.5000
.3000000	212.6117
.6000000	267.8739
.9000000	306.6391
1.2000	337.5000
1.5000	363.5609
1.8000	386.3411
2.1000	406.7115
2.4000	425.2234
2.7000	442.2501
3.0000	458.0580
3.3000	472.8441
3.6000	486.7592
9.6000	486.0000
18.0000	486.0000
24.0000	486.0000

 Computed Values of Load Distribution and Deflection
 for Lateral Loading for Load Case Number 1

Pile-head boundary conditions are Shear and Moment (BC Type 1)
 Specified shear force at pile head = 1000.000 lbs
 Specified moment at pile head = 1000.000 in-lbs
 Specified axial load at pile head = 1000.000 lbs

Non-zero moment for this load case indicates the pile-head may rotate under the applied pile-head loading, but is not a free-head (zero moment) condition.

Depth	Deflect.	Moment	Shear	Slope	Total	Soil Res.
Es*h	y	M	V	S	Stress	p
F/L	X					

in lbs/in	in	24 inch lbs-in	pipe - stratum 1 through lbs	4.7po Rad.	lbs/in**2	lbs/in
0.000	.212185	1000.0000	1000.0000	-.0080623	31.7999	0.0000
0.0000						
16.900	.077799	18034.3857	382.2779	-.0059593	111.9806	-73.1032
15879.9160						
33.800	.010760	14122.4169	-406.3130	-.0024065	93.5670	-20.2211
31759.8320						
50.700	-.003541	4382.3478	-423.3863	-.0003620	47.7206	18.2006
86862.5170						
67.600	-.001477	-175.8028	-139.8727	.0001027	27.9204	15.3513
175638.						
84.500	-6.96E-05	-348.8207	4.1799	4.4746E-05	28.7348	1.6964
411920.						
101.400	3.53E-05	-36.0337	10.5102	2.2255E-06	27.2625	-.9472321
453568.						
118.300	5.62E-06	6.3489	1.1136	-1.0542E-06	27.1228	-.1647877
495215.						
135.200	-3.38E-07	1.6427	-.1881220	-1.7126E-07	27.1007	.0107338
536862.						
152.100	-1.65E-07	-.0038687	-.0497223	9.8084E-09	27.0929	.0056449
578509.						
169.000	-6.37E-09	-.0382154	-5.9949E-05	5.1588E-09	27.0931	.0002323
616768.						
185.900	9.46E-09	-.0060694	.0011643	2.6610E-10	27.0930	-8.7423E-05
156111.						
202.800	2.63E-09	.0011303	.0001996	-2.7958E-10	27.0929	-2.6752E-05
171991.						
219.700	1.43E-11	.0006850	-3.2762E-05	-7.9021E-11	27.0929	-7.4038E-07
875533.						
236.600	-4.22E-11	2.5630E-05	-2.0550E-05	-5.1022E-13	27.0929	2.1856E-06
875533.						
253.500	-2.95E-12	-9.5814E-06	-7.8797E-07	1.2629E-12	27.0929	1.5305E-07
875533.						
270.400	4.99E-13	-1.0456E-06	2.8674E-07	8.8822E-14	27.0929	-2.5863E-08
875533.						
287.300	4.80E-14	1.0723E-07	3.1341E-08	-1.4854E-14	27.0929	-4.3606E-09
1535789.						
304.200	-2.84E-15	1.4231E-08	-3.1881E-09	-1.4349E-15	27.0929	2.7428E-10
1634263.						
321.100	-5.14E-16	-4.8268E-10	-4.2509E-10	8.4108E-17	27.0929	5.2711E-11
1734362.						
338.000	6.57E-18	-1.3993E-10	1.4282E-11	1.5320E-17	27.0929	-7.1360E-13
1836160.						
354.900	4.21E-18	-4.7416E-13	4.1717E-12	-1.9210E-19	27.0929	-4.8285E-13
1939740.						
371.800	7.50E-20	1.0790E-12	1.4925E-14	-1.2528E-19	27.0929	-9.0806E-15
2045190.						
388.700	-2.76E-20	3.4532E-14	-3.2122E-14	-2.2567E-21	27.0929	3.5130E-15
2152606.						
405.600	-1.24E-21	-6.6816E-15	-1.0329E-15	8.2028E-22	27.0929	1.6618E-16
2262088.						
422.500	1.45E-22	-4.0738E-16	1.9869E-16	3.7062E-23	27.0929	-2.0432E-17
2373749.						
439.400	1.12E-23	3.2813E-17	1.2146E-17	-4.3213E-24	27.0929	-1.6442E-18
2487708.						
456.300	-5.94E-25	3.2886E-18	-9.7460E-19	-3.3271E-25	27.0929	9.1488E-20
2604096.						
473.200	0.000	-1.1781E-19	-9.7904E-20	0.0000	27.0929	1.2264E-20
2723054.						
490.100	0.000	-2.1109E-20	3.4934E-21	0.0000	27.0929	-2.6427E-22

24 inch pipe - stratum 1 through 4.1po

2844737.						
507.000	0.000	1.9234E-22	6.2783E-22	0.0000	27.0929	-7.4854E-23
2969314.						
523.900	0.000	1.1356E-22	-5.6807E-24	0.0000	27.0929	-1.1760E-25
5340698.						
540.800	0.000	7.5843E-25	-3.3692E-24	0.0000	27.0929	3.9116E-25
5340698.						
557.700	0.000	-3.2226E-25	0.0000	0.0000	27.0929	0.0000
5340698.						
574.600	0.000	0.0000	0.0000	0.0000	27.0929	0.0000
5340698.						
591.500	0.000	0.0000	0.0000	0.0000	27.0929	0.0000
5340698.						
608.400	0.000	0.0000	0.0000	0.0000	27.0929	0.0000
5340698.						
625.300	0.000	0.0000	0.0000	0.0000	27.0929	0.0000
6705010.						
642.200	0.000	0.0000	0.0000	0.0000	27.0929	0.0000
6705010.						
659.100	0.000	0.0000	0.0000	0.0000	27.0929	0.0000
6705010.						
676.000	0.000	0.0000	0.0000	0.0000	27.0929	0.0000
6705010.						
692.900	0.000	0.0000	0.0000	0.0000	27.0929	0.0000
6705010.						
709.800	0.000	0.0000	0.0000	0.0000	27.0929	0.0000
6705010.						
726.700	0.000	0.0000	0.0000	0.0000	27.0929	0.0000
6705010.						
743.600	0.000	0.0000	0.0000	0.0000	27.0929	0.0000
6705010.						
760.500	0.000	0.0000	0.0000	0.0000	27.0929	0.0000
6705010.						
777.400	0.000	0.0000	0.0000	0.0000	27.0929	0.0000
6705010.						
794.300	0.000	0.0000	0.0000	0.0000	27.0929	0.0000
6705010.						
811.200	0.000	0.0000	0.0000	0.0000	27.0929	0.0000
6705010.						
828.100	0.000	0.0000	0.0000	0.0000	27.0929	0.0000
5486330.						
845.000	0.000	0.0000	0.0000	0.0000	27.0929	0.0000
5486330.						
861.900	0.000	0.0000	0.0000	0.0000	27.0929	0.0000
5486330.						
878.800	0.000	0.0000	0.0000	0.0000	27.0929	0.0000
5486330.						
895.700	0.000	0.0000	0.0000	0.0000	27.0929	0.0000
5486330.						
912.600	0.000	0.0000	0.0000	0.0000	27.0929	0.0000
5486330.						
929.500	0.000	0.0000	0.0000	0.0000	27.0929	0.0000
5486330.						
946.400	0.000	0.0000	0.0000	0.0000	27.0929	0.0000
5486330.						
963.300	0.000	0.0000	0.0000	0.0000	27.0929	0.0000
5486330.						
980.200	0.000	0.0000	0.0000	0.0000	27.0929	0.0000
5486330.						
997.100	0.000	0.0000	0.0000	0.0000	27.0929	0.0000
5486330.						
1014.	0.000	0.0000	0.0000	0.0000	27.0929	0.0000
5486330.						

		24 inch pipe - stratum 1 through 4.1po					
1031.	0.000	0.0000	0.0000	0.0000	27.0929	0.0000	
5486330.							
1048.	0.000	0.0000	0.0000	0.0000	27.0929	0.0000	
5486330.							
1065.	0.000	0.0000	0.0000	0.0000	27.0929	0.0000	
5486330.							
1082.	0.000	0.0000	0.0000	0.0000	27.0929	0.0000	
5486330.							
1099.	0.000	0.0000	0.0000	0.0000	27.0929	0.0000	
5486330.							
1115.	0.000	0.0000	0.0000	0.0000	27.0929	0.0000	
5486330.							
1132.	0.000	0.0000	0.0000	0.0000	27.0929	0.0000	
5486330.							
1149.	0.000	0.0000	0.0000	0.0000	27.0929	0.0000	
5486330.							
1166.	0.000	0.0000	0.0000	0.0000	27.0929	0.0000	
5486330.							
1183.	0.000	0.0000	0.0000	0.0000	27.0929	0.0000	
5486330.							
1200.	0.000	0.0000	0.0000	0.0000	27.0929	0.0000	
5486330.							
1217.	0.000	0.0000	0.0000	0.0000	27.0929	0.0000	
7404154.							
1234.	0.000	0.0000	0.0000	0.0000	27.0929	0.0000	
7404154.							
1251.	0.000	0.0000	0.0000	0.0000	27.0929	0.0000	
7404154.							
1268.	0.000	0.0000	0.0000	0.0000	27.0929	0.0000	
7404154.							
1284.	0.000	0.0000	0.0000	0.0000	27.0929	0.0000	
7404154.							
1301.	0.000	0.0000	0.0000	0.0000	27.0929	0.0000	
7404154.							
1318.	0.000	0.0000	0.0000	0.0000	27.0929	0.0000	
7404154.							
1335.	0.000	0.0000	0.0000	0.0000	27.0929	0.0000	
7404154.							
1352.	0.000	0.0000	0.0000	0.0000	27.0929	0.0000	
7404154.							
1369.	0.000	0.0000	0.0000	0.0000	27.0929	0.0000	
1.0911E+07							
1386.	0.000	0.0000	0.0000	0.0000	27.0929	0.0000	
1.0911E+07							
1403.	0.000	0.0000	0.0000	0.0000	27.0929	0.0000	
1.0911E+07							
1420.	0.000	0.0000	0.0000	0.0000	27.0929	0.0000	
1.0911E+07							
1436.	0.000	0.0000	0.0000	0.0000	27.0929	0.0000	
1.0911E+07							
1453.	0.000	0.0000	0.0000	0.0000	27.0929	0.0000	
1.0911E+07							
1470.	0.000	0.0000	0.0000	0.0000	27.0929	0.0000	
1.0911E+07							
1487.	0.000	0.0000	0.0000	0.0000	27.0929	0.0000	
1.0911E+07							
1504.	0.000	0.0000	0.0000	0.0000	27.0929	0.0000	
1.0911E+07							
1521.	0.000	0.0000	0.0000	0.0000	27.0929	0.0000	
1.0911E+07							
1538.	0.000	0.0000	0.0000	0.0000	27.0929	0.0000	
1.0911E+07							
1555.	0.000	0.0000	0.0000	0.0000	27.0929	0.0000	

24 inch pipe - stratum 1 through 4.1po

1.0911E+07						
1572.	0.000	0.0000	0.0000	0.0000	27.0929	0.0000
1.0911E+07						
1589.	0.000	0.0000	0.0000	0.0000	27.0929	0.0000
1.0911E+07						
1605.	0.000	0.0000	0.0000	0.0000	27.0929	0.0000
1.0911E+07						
1622.	0.000	0.0000	0.0000	0.0000	27.0929	0.0000
1.0911E+07						
1639.	0.000	0.0000	0.0000	0.0000	27.0929	0.0000
1.0911E+07						
1656.	0.000	0.0000	0.0000	0.0000	27.0929	0.0000
1.0911E+07						
1673.	0.000	0.0000	0.0000	0.0000	27.0929	0.0000
1.0911E+07						
1690.	0.000	0.0000	0.0000	0.0000	27.0929	0.0000
5455523.						

Output Verification:

Computed forces and moments are within specified convergence limits.

Output Summary for Load Case No. 1:

Pile-head deflection = .21218486 in
 Computed slope at pile head = -.00806230
 Maximum bending moment = 18034.38569 lbs-in
 Maximum shear force = 1000.00000 lbs
 Depth of maximum bending moment = 16.90000000 in
 Depth of maximum shear force = 0.00000 in
 Number of iterations = 12
 Number of zero deflection points = 45

 Summary of Pile Response(s)

Definition of symbols for Pile-Head Loading Conditions:

Type 1 = Shear and Moment, y = pile-head displacement in
 Type 2 = Shear and Slope, M = Pile-head Moment lbs-in
 Type 3 = Shear and Rot. Stiffness, V = Pile-head Shear Force lbs
 Type 4 = Deflection and Moment, S = Pile-head Slope, radians
 Type 5 = Deflection and Slope, R = Rot. Stiffness of Pile-head in-lbs/rad

Load Type	Pile-Head Condition 1	Pile-Head Condition 2	Axial Load lbs	Pile-Head Deflection in	Maximum Moment in-lbs	Maximum Shear lbs
1	V= 1000.000	M= 1000.000	1000.0000	.2121849	18034.3857	1000.0000

The analysis ended normally.

24 inch pipe - stratum 5 through 7.lpo

LPILE Plus for windows, Version 5.0 (5.0.30)

Analysis of Individual Piles and Drilled Shafts
Subjected to Lateral Loading Using the p-y Method

(c) 1985-2007 by Ensoft, Inc.
All Rights Reserved

This program is licensed to:

DJI
Eustis

Path to file locations: U:\sys\WPDATA\Projects\20749\Piles\LPile\
Name of input data file: 24 inch pipe - stratum 5 through 7.lpd
Name of output file: 24 inch pipe - stratum 5 through 7.lpo
Name of plot output file: 24 inch pipe - stratum 5 through 7.lpp
Name of runtime file: 24 inch pipe - stratum 5 through 7.lpr

Time and Date of Analysis

Date: November 9, 2009 Time: 17:54:16

Problem Title

EE20749 - St. Mary Floodgate Structure at Franklin Drainage Canal

Program Options

Units Used in Computations - US Customary Units: Inches, Pounds

Basic Program Options:

Analysis Type 1:

- Computation of Lateral Pile Response Using User-specified Constant EI

Computation Options:

- Only internally-generated p-y curves used in analysis
- Analysis does not use p-y multipliers (individual pile or shaft action only)
- Analysis assumes no shear resistance at pile tip
- Analysis for fixed-length pile or shaft only
- No computation of foundation stiffness matrix elements
- Output pile response for full length of pile
- Analysis assumes no soil movements acting on pile
- Additional p-y curves computed at specified depths

Solution Control Parameters:

- Number of pile increments = 100
- Maximum number of iterations allowed = 100

- 24 inch pipe - stratum 5 through 7.lpo
- Deflection tolerance for convergence = 1.0000E-05 in
 - Maximum allowable deflection = 1.0000E+02 in

Printing Options:

- Values of pile-head deflection, bending moment, shear force, and soil reaction are printed for full length of pile.
- Printing Increment (spacing of output points) = 1

Pile Structural Properties and Geometry

Pile Length = 1690.00 in
Depth of ground surface below top of pile = .00 in
Slope angle of ground surface = .00 deg.

Structural properties of pile defined using 2 points

Point	Depth X in	Pile Diameter in	Moment of Inertia in**4	Pile Area Sq.in	Modulus of Elasticity lbs/Sq.in
1	0.0000	24.00000000	2549.4000	36.9100	30000.00000
2	1690.0000	24.00000000	2549.4000	36.9100	30000.00000

Soil and Rock Layering Information

The soil profile is modelled using 10 layers

Layer 1 is silt with cohesion and friction
Distance from top of pile to top of layer = .000 in
Distance from top of pile to bottom of layer = 36.000 in
p-y subgrade modulus k for top of soil layer = 55.600 lbs/in**3
p-y subgrade modulus k for bottom of layer = 55.600 lbs/in**3

Layer 2 is soft clay, p-y criteria by Matlock, 1970
Distance from top of pile to top of layer = 36.000 in
Distance from top of pile to bottom of layer = 180.000 in

Layer 3 is silt with cohesion and friction
Distance from top of pile to top of layer = 180.000 in
Distance from top of pile to bottom of layer = 204.000 in
p-y subgrade modulus k for top of soil layer = 55.600 lbs/in**3
p-y subgrade modulus k for bottom of layer = 55.600 lbs/in**3

Layer 4 is soft clay, p-y criteria by Matlock, 1970
Distance from top of pile to top of layer = 204.000 in
Distance from top of pile to bottom of layer = 276.000 in

Layer 5 is soft clay, p-y criteria by Matlock, 1970
Distance from top of pile to top of layer = 276.000 in
Distance from top of pile to bottom of layer = 516.000 in

Layer 6 is stiff clay without free water
Distance from top of pile to top of layer = 516.000 in
Distance from top of pile to bottom of layer = 612.000 in

Layer 7 is stiff clay without free water
Distance from top of pile to top of layer = 612.000 in

24 inch pipe - stratum 5 through 7.1po
 Distance from top of pile to bottom of layer = 828.000 in

Layer 8 is stiff clay without free water
 Distance from top of pile to top of layer = 828.000 in
 Distance from top of pile to bottom of layer = 1212.000 in

Layer 9 is stiff clay without free water
 Distance from top of pile to top of layer = 1212.000 in
 Distance from top of pile to bottom of layer = 1356.000 in

Layer 10 is stiff clay without free water
 Distance from top of pile to top of layer = 1356.000 in
 Distance from top of pile to bottom of layer = 1692.000 in

(Depth of lowest layer extends 2.00 in below pile tip)

 Effective Unit Weight of Soil vs. Depth

Distribution of effective unit weight of soil with depth
 is defined using 20 points

Point No.	Depth X in	Eff. Unit Weight lbs/in**3
1	.00	.03160
2	36.00	.03160
3	36.00	.03330
4	180.00	.03330
5	180.00	.03160
6	204.00	.03160
7	204.00	.03480
8	276.00	.03480
9	276.00	.03250
10	516.00	.03250
11	516.00	.03620
12	612.00	.03620
13	612.00	.03550
14	828.00	.03550
15	828.00	.03110
16	1212.00	.03110
17	1212.00	.03040
18	1356.00	.03040
19	1356.00	.03450
20	1692.00	.03450

 Shear Strength of Soils

Distribution of shear strength parameters with depth
 defined using 20 points

Point No.	Depth X in	Cohesion c lbs/in**2	Angle of Friction Deg.	E50 or k _{rm}	RQD %
1	.000	1.38890	15.00	.02000	.0
2	36.000	1.38890	15.00	.02000	.0

24 inch pipe - stratum 5 through 7.lpo						
3	36.000	2.20140	.00	.02000	.0	
4	180.000	2.20140	.00	.02000	.0	
5	180.000	1.38890	15.00	.02000	.0	
6	204.000	1.38890	15.00	.02000	.0	
7	204.000	3.12500	.00	.02000	.0	
8	276.000	3.12500	.00	.02000	.0	
9	276.000	4.16670	.00	.01000	.0	
10	516.000	7.63890	.00	.00700	.0	
11	516.000	7.63890	.00	.00700	.0	
12	612.000	7.63890	.00	.00700	.0	
13	612.000	9.59030	.00	.00700	.0	
14	828.000	9.59030	.00	.00700	.0	
15	828.000	7.84720	.00	.00700	.0	
16	1212.000	7.84720	.00	.00700	.0	
17	1212.000	10.59030	.00	.00700	.0	
18	1356.000	10.59030	.00	.00700	.0	
19	1356.000	14.34720	.00	.00500	.0	
20	1692.000	14.34720	.00	.00500	.0	

Notes:

- (1) Cohesion = uniaxial compressive strength for rock materials.
- (2) Values of E50 are reported for clay strata.
- (3) Default values will be generated for E50 when input values are 0.
- (4) RQD and k_{rm} are reported only for weak rock strata.

Loading Type

Cyclic loading criteria was used for computation of p-y curves

Number of cycles of loading = 1000.

Pile-head Loading and Pile-head Fixity Conditions

Number of loads specified = 1

Load Case Number 1

Pile-head boundary conditions are Shear and Moment (BC Type 1)

Shear force at pile head = 1000.000 lbs
 Bending moment at pile head = 1000.000 in-lbs
 Axial load at pile head = 1000.000 lbs

Non-zero moment at pile head for this load case indicates the pile-head may rotate under the applied pile-head loading, but is not a free-head (zero moment) condition.

Output of p-y Curves at Specified Depths

24 inch pipe - stratum 5 through 7.lpo

p-y curves are generated and printed for verification at 9 depths.

Depth No.	Depth Below Pile Head in	Depth Below Ground Surface in
1	288.000	288.000
2	396.000	396.000
3	504.000	504.000
4	528.000	528.000
5	564.000	564.000
6	600.000	600.000
7	624.000	624.000
8	720.000	720.000
9	816.000	816.000

Depth of ground surface below top of pile = .00 in

p-y Curve Computed Using the Soft Clay Criteria for Cyclic Loading Conditions

Soil Layer Number = 5
 Depth below pile head = 288.000 in
 Depth below ground surface = 288.000 in
 Equivalent Depth = 312.568 in
 Pile Diameter = 24.000 in
 Cohesion, c = 4.340 lbs/in**2
 Avg Eff Unit Weight = .03329 lbs/in**3
 E50 parameter = .00985
 Default J parameter = .500
 Y50 = .59100 in
 p-multiplier = 1.00000
 y-multiplier = 1.00000
 Number of cycles of loading = 1000.
 Xr = 210.506 in

y, in	p, lbs/in
0.0000	0.0000
.0047280	93.7507
.1477500	295.2962
.2955000	372.0499
.4432500	425.8908
.5910000	468.7535
.7387500	504.9494
.8865000	536.5888
1.0343	564.8813
1.1820	590.5924
1.3298	614.2408
1.4775	636.1964
1.6253	656.7329
1.7730	675.0050
4.7280	675.0050
8.8650	675.0050
11.8200	675.0050

p-y Curve Computed Using the Soft Clay Criteria for Cyclic Loading Conditions

Soil Layer Number = 5
 Depth below pile head = 396.000 in
 Depth below ground surface = 396.000 in
 Page 5

24 inch pipe - stratum 5 through 7.lpo

Equivalent Depth = 420.568 in
 Pile Diameter = 24.000 in
 Cohesion, c = 5.903 lbs/in**2
 Avg Eff Unit Weight = .03307 lbs/in**3
 E50 parameter = .00850
 Default J parameter = .500
 Y50 = .51000 in
 p-multiplier = 1.00000
 y-multiplier = 1.00000
 Number of cycles of loading = 1000.
 Xr = 226.961 in

y, in	p, lbs/in
0.0000	0.0000
.0040800	127.5005
.1275000	401.6013
.2550000	505.9860
.3825000	579.2094
.5100000	637.5024
.6375000	686.7286
.7650000	729.7581
.8925000	768.2357
1.0200	803.2027
1.1475	835.3645
1.2750	865.2239
1.4025	893.1534
1.5300	919.4376
4.0800	918.0035
7.6500	918.0035
10.2000	918.0035

p-y Curve Computed Using the Soft Clay Criteria for Cyclic Loading Conditions

Soil Layer Number = 5
 Depth below pile head = 504.000 in
 Depth below ground surface = 504.000 in
 Equivalent Depth = 528.568 in
 Pile Diameter = 24.000 in
 Cohesion, c = 7.465 lbs/in**2
 Avg Eff Unit Weight = .03295 lbs/in**3
 E50 parameter = .00715
 Default J parameter = .500
 Y50 = .42900 in
 p-multiplier = 1.00000
 y-multiplier = 1.00000
 Number of cycles of loading = 1000.
 Xr = 237.651 in

y, in	p, lbs/in
0.0000	0.0000
.0034320	161.2503
.1072500	507.9065
.2145000	639.9221
.3217500	732.5279
.4290000	806.2513
.5362500	868.5079
.6435000	922.9274
.7507500	971.5902
.8580000	1015.8130
.9652500	1056.4881

	24 inch pipe - stratum 5 through 7.1po
1.0725	1094.2514
1.1797	1129.5740
1.2870	1162.8156
3.4320	1161.0019
6.4350	1161.0019
8.5800	1161.0019

p-y Curve Computed Using Cyclic Criteria for Stiff Clay without Free Water

Soil Layer Number	=	6
Depth below pile head	=	528.000 in
Depth below ground surface	=	528.000 in
Equivalent Depth	=	300.910 in
Diameter	=	24.000 in
Undrained cohesion, c	=	7.63890 lbs/in**2
Average Eff. Unit Weight	=	.03301 lbs/in**3
Epsilon-50	=	.00700
Pct	=	1937.732 lbs/in
Pcd	=	1650.002 lbs/in
Pu	=	1650.002 lbs/in
y50	=	.420 in
p-multiplier	=	1.00000
y-multiplier	=	1.00000
Number of cycles of loading	=	1000.

y, in	p, lbs/in
0.0000	0.0000
6.7200E-05	71.7290
.0003360	107.2599
.0006720	127.5543
.0033600	190.7382
.0067200	226.8272
.0336000	339.1857
.0672000	403.3621
.1680000	507.2010
.3360000	603.1670
.5040000	667.5140
.6720000	717.2905
1.6800	901.9450
3.3600	1072.5994
6.7200	1275.5429
15.1200	1562.2146
23.5200	1650.0024

p-y Curve Computed Using Cyclic Criteria for Stiff Clay without Free Water

Soil Layer Number	=	6
Depth below pile head	=	564.000 in
Depth below ground surface	=	564.000 in
Equivalent Depth	=	336.910 in
Diameter	=	24.000 in
Undrained cohesion, c	=	7.63890 lbs/in**2
Average Eff. Unit Weight	=	.03322 lbs/in**3
Epsilon-50	=	.00700
Pct	=	2105.400 lbs/in
Pcd	=	1650.002 lbs/in
Pu	=	1650.002 lbs/in

Page 7

24 inch pipe - stratum 5 through 7.lpo

y50 = .420 in
 p-multiplier = 1.00000
 y-multiplier = 1.00000
 Number of cycles of loading = 1000.

y, in	p, lbs/in
0.0000	0.0000
6.7200E-05	71.7290
.0003360	107.2599
.0006720	127.5543
.0033600	190.7382
.0067200	226.8272
.0336000	339.1857
.0672000	403.3621
.1680000	507.2010
.3360000	603.1670
.5040000	667.5140
.6720000	717.2905
1.6800	901.9450
3.3600	1072.5994
6.7200	1275.5429
15.1200	1562.2146
23.5200	1650.0024

p-y Curve Computed Using Cyclic Criteria for Stiff Clay without Free Water

Soil Layer Number = 6
 Depth below pile head = 600.000 in
 Depth below ground surface = 600.000 in
 Equivalent Depth = 372.910 in
 Diameter = 24.000 in
 Undrained cohesion, c = 7.63890 lbs/in**2
 Average Eff. Unit Weight = .03340 lbs/in**3
 Epsilon-50 = .00700
 Pct = 2273.202 lbs/in
 Pcd = 1650.002 lbs/in
 Pu = 1650.002 lbs/in
 y50 = .420 in
 p-multiplier = 1.00000
 y-multiplier = 1.00000
 Number of cycles of loading = 1000.

y, in	p, lbs/in
0.0000	0.0000
6.7200E-05	71.7290
.0003360	107.2599
.0006720	127.5543
.0033600	190.7382
.0067200	226.8272
.0336000	339.1857
.0672000	403.3621
.1680000	507.2010
.3360000	603.1670
.5040000	667.5140
.6720000	717.2905
1.6800	901.9450
3.3600	1072.5994
6.7200	1275.5429
15.1200	1562.2146
23.5200	1650.0024

24 inch pipe - stratum 5 through 7.lpo

p-y Curve Computed Using Cyclic Criteria for Stiff Clay without Free Water

Soil Layer Number = 7
 Depth below pile head = 624.000 in
 Depth below ground surface = 624.000 in
 Equivalent Depth = 331.177 in
 Diameter = 24.000 in
 Undrained cohesion, c = 9.59030 lbs/in**2
 Average Eff. Unit Weight = .03349 lbs/in**3
 Epsilon-50 = .00700
 Pct = 2544.737 lbs/in
 Pcd = 2071.505 lbs/in
 Pu = 2071.505 lbs/in
 y50 = .420 in
 p-multiplier = 1.00000
 y-multiplier = 1.00000
 Number of cycles of loading = 1000.

y, in	p, lbs/in
0.0000	0.0000
6.7200E-05	90.0526
.0003360	134.6601
.0006720	160.1387
.0033600	239.4633
.0067200	284.7714
.0336000	425.8326
.0672000	506.4032
.1680000	636.7683
.3360000	757.2494
.5040000	838.0342
.6720000	900.5264
1.6800	1132.3520
3.3600	1346.6010
6.7200	1601.3875
15.1200	1961.2911
23.5200	2071.5048

p-y Curve Computed Using Cyclic Criteria for Stiff Clay without Free Water

Soil Layer Number = 7
 Depth below pile head = 720.000 in
 Depth below ground surface = 720.000 in
 Equivalent Depth = 427.177 in
 Diameter = 24.000 in
 Undrained cohesion, c = 9.59030 lbs/in**2
 Average Eff. Unit Weight = .03376 lbs/in**3
 Epsilon-50 = .00700
 Pct = 3084.980 lbs/in
 Pcd = 2071.505 lbs/in
 Pu = 2071.505 lbs/in
 y50 = .420 in
 p-multiplier = 1.00000
 y-multiplier = 1.00000
 Number of cycles of loading = 1000.

y, in p, lbs/in

24 inch pipe - stratum 5 through 7.lpo

0.0000	0.0000
6.7200E-05	90.0526
.0003360	134.6601
.0006720	160.1387
.0033600	239.4633
.0067200	284.7714
.0336000	425.8326
.0672000	506.4032
.1680000	636.7683
.3360000	757.2494
.5040000	838.0342
.6720000	900.5264
1.6800	1132.3520
3.3600	1346.6010
6.7200	1601.3875
15.1200	1961.2911
23.5200	2071.5048

p-y Curve Computed Using Cyclic Criteria for Stiff Clay without Free Water

Soil Layer Number	=	7
Depth below pile head	=	816.000 in
Depth below ground surface	=	816.000 in
Equivalent Depth	=	523.177 in
Diameter	=	24.000 in
Undrained cohesion, c	=	9.59030 lbs/in**2
Average Eff. Unit Weight	=	.03396 lbs/in**3
Epsilon-50	=	.00700
Pct	=	3625.666 lbs/in
Pcd	=	2071.505 lbs/in
Pu	=	2071.505 lbs/in
y50	=	.420 in
p-multiplier	=	1.00000
y-multiplier	=	1.00000
Number of cycles of loading	=	1000.

y, in	p, lbs/in
0.0000	0.0000
6.7200E-05	90.0526
.0003360	134.6601
.0006720	160.1387
.0033600	239.4633
.0067200	284.7714
.0336000	425.8326
.0672000	506.4032
.1680000	636.7683
.3360000	757.2494
.5040000	838.0342
.6720000	900.5264
1.6800	1132.3520
3.3600	1346.6010
6.7200	1601.3875
15.1200	1961.2911
23.5200	2071.5048

24 inch pipe - stratum 5 through 7.lpo
 Computed Values of Load Distribution and Deflection
 for Lateral Loading for Load Case Number 1

Pile-head boundary conditions are Shear and Moment (BC Type 1)
 Specified shear force at pile head = 1000.000 lbs
 Specified moment at pile head = 1000.000 in-lbs
 Specified axial load at pile head = 1000.000 lbs

Non-zero moment for this load case indicates the pile-head may rotate under the applied pile-head loading, but is not a free-head (zero moment) condition.

Depth Es*h X F/L in lbs/in	Deflect. y in	Moment M lbs-in	Shear V lbs	Slope S Rad.	Total Stress lbs/in**2	Soil Res. p lbs/in
0.000	.212185	1000.0000	1000.0000	-.0080623	31.7999	0.0000
16.900	.077799	18034.3857	382.2779	-.0059593	111.9806	-73.1032
33.800	.010760	14122.4169	-406.3130	-.0024065	93.5670	-20.2211
50.700	-.003541	4382.3478	-423.3863	-.0003620	47.7206	18.2006
67.600	-.001477	-175.8028	-139.8727	.0001027	27.9204	15.3513
84.500	-6.96E-05	-348.8207	4.1799	4.4746E-05	28.7348	1.6964
101.400	3.53E-05	-36.0337	10.5102	2.2255E-06	27.2625	-.9472321
118.300	5.62E-06	6.3489	1.1136	-1.0542E-06	27.1228	-.1647877
135.200	-3.38E-07	1.6427	-.1881220	-1.7126E-07	27.1007	.0107338
152.100	-1.65E-07	-.0038687	-.0497223	9.8084E-09	27.0929	.0056449
169.000	-6.37E-09	-.0382154	-5.9949E-05	5.1588E-09	27.0931	.0002323
185.900	9.46E-09	-.0060694	.0011643	2.6610E-10	27.0930	-8.7423E-05
202.800	2.63E-09	.0011303	.0001996	-2.7958E-10	27.0929	-2.6752E-05
219.700	1.43E-11	.0006850	-3.2762E-05	-7.9021E-11	27.0929	-7.4038E-07
236.600	-4.22E-11	2.5630E-05	-2.0550E-05	-5.1022E-13	27.0929	2.1856E-06
253.500	-2.95E-12	-9.5814E-06	-7.8797E-07	1.2629E-12	27.0929	1.5305E-07
270.400	4.99E-13	-1.0456E-06	2.8674E-07	8.8822E-14	27.0929	-2.5863E-08
287.300	4.80E-14	1.0723E-07	3.1341E-08	-1.4854E-14	27.0929	-4.3606E-09
304.200	-2.84E-15	1.4231E-08	-3.1881E-09	-1.4349E-15	27.0929	2.7428E-10
321.100	-5.14E-16	-4.8268E-10	-4.2509E-10	8.4108E-17	27.0929	5.2711E-11
338.000	6.57E-18	-1.3993E-10	1.4282E-11	1.5320E-17	27.0929	-7.1360E-13
354.900	4.21E-18	-4.7416E-13	4.1717E-12	-1.9210E-19	27.0929	-4.8285E-13

24 inch pipe - stratum 5 through 7.lpo

1939740.						
371.800	7.50E-20	1.0790E-12	1.4925E-14	-1.2528E-19	27.0929	-9.0806E-15
2045190.						
388.700	-2.76E-20	3.4532E-14	-3.2122E-14	-2.2567E-21	27.0929	3.5130E-15
2152606.						
405.600	-1.24E-21	-6.6816E-15	-1.0329E-15	8.2028E-22	27.0929	1.6618E-16
2262088.						
422.500	1.45E-22	-4.0738E-16	1.9869E-16	3.7062E-23	27.0929	-2.0432E-17
2373749.						
439.400	1.12E-23	3.2813E-17	1.2146E-17	-4.3213E-24	27.0929	-1.6442E-18
2487708.						
456.300	-5.94E-25	3.2886E-18	-9.7460E-19	-3.3271E-25	27.0929	9.1488E-20
2604096.						
473.200	0.000	-1.1781E-19	-9.7904E-20	0.0000	27.0929	1.2264E-20
2723054.						
490.100	0.000	-2.1109E-20	3.4934E-21	0.0000	27.0929	-2.6427E-22
2844737.						
507.000	0.000	1.9234E-22	6.2783E-22	0.0000	27.0929	-7.4854E-23
2969314.						
523.900	0.000	1.1356E-22	-5.6807E-24	0.0000	27.0929	-1.1760E-25
5340698.						
540.800	0.000	7.5843E-25	-3.3692E-24	0.0000	27.0929	3.9116E-25
5340698.						
557.700	0.000	-3.2226E-25	0.0000	0.0000	27.0929	0.0000
5340698.						
574.600	0.000	0.0000	0.0000	0.0000	27.0929	0.0000
5340698.						
591.500	0.000	0.0000	0.0000	0.0000	27.0929	0.0000
5340698.						
608.400	0.000	0.0000	0.0000	0.0000	27.0929	0.0000
5340698.						
625.300	0.000	0.0000	0.0000	0.0000	27.0929	0.0000
6705010.						
642.200	0.000	0.0000	0.0000	0.0000	27.0929	0.0000
6705010.						
659.100	0.000	0.0000	0.0000	0.0000	27.0929	0.0000
6705010.						
676.000	0.000	0.0000	0.0000	0.0000	27.0929	0.0000
6705010.						
692.900	0.000	0.0000	0.0000	0.0000	27.0929	0.0000
6705010.						
709.800	0.000	0.0000	0.0000	0.0000	27.0929	0.0000
6705010.						
726.700	0.000	0.0000	0.0000	0.0000	27.0929	0.0000
6705010.						
743.600	0.000	0.0000	0.0000	0.0000	27.0929	0.0000
6705010.						
760.500	0.000	0.0000	0.0000	0.0000	27.0929	0.0000
6705010.						
777.400	0.000	0.0000	0.0000	0.0000	27.0929	0.0000
6705010.						
794.300	0.000	0.0000	0.0000	0.0000	27.0929	0.0000
6705010.						
811.200	0.000	0.0000	0.0000	0.0000	27.0929	0.0000
6705010.						
828.100	0.000	0.0000	0.0000	0.0000	27.0929	0.0000
5486330.						
845.000	0.000	0.0000	0.0000	0.0000	27.0929	0.0000
5486330.						
861.900	0.000	0.0000	0.0000	0.0000	27.0929	0.0000
5486330.						
878.800	0.000	0.0000	0.0000	0.0000	27.0929	0.0000
5486330.						

		24 inch pipe - stratum 5 through 7.1po					
895.700	0.000	0.0000	0.0000	0.0000	27.0929	0.0000	
5486330.							
912.600	0.000	0.0000	0.0000	0.0000	27.0929	0.0000	
5486330.							
929.500	0.000	0.0000	0.0000	0.0000	27.0929	0.0000	
5486330.							
946.400	0.000	0.0000	0.0000	0.0000	27.0929	0.0000	
5486330.							
963.300	0.000	0.0000	0.0000	0.0000	27.0929	0.0000	
5486330.							
980.200	0.000	0.0000	0.0000	0.0000	27.0929	0.0000	
5486330.							
997.100	0.000	0.0000	0.0000	0.0000	27.0929	0.0000	
5486330.							
1014.	0.000	0.0000	0.0000	0.0000	27.0929	0.0000	
5486330.							
1031.	0.000	0.0000	0.0000	0.0000	27.0929	0.0000	
5486330.							
1048.	0.000	0.0000	0.0000	0.0000	27.0929	0.0000	
5486330.							
1065.	0.000	0.0000	0.0000	0.0000	27.0929	0.0000	
5486330.							
1082.	0.000	0.0000	0.0000	0.0000	27.0929	0.0000	
5486330.							
1099.	0.000	0.0000	0.0000	0.0000	27.0929	0.0000	
5486330.							
1115.	0.000	0.0000	0.0000	0.0000	27.0929	0.0000	
5486330.							
1132.	0.000	0.0000	0.0000	0.0000	27.0929	0.0000	
5486330.							
1149.	0.000	0.0000	0.0000	0.0000	27.0929	0.0000	
5486330.							
1166.	0.000	0.0000	0.0000	0.0000	27.0929	0.0000	
5486330.							
1183.	0.000	0.0000	0.0000	0.0000	27.0929	0.0000	
5486330.							
1200.	0.000	0.0000	0.0000	0.0000	27.0929	0.0000	
5486330.							
1217.	0.000	0.0000	0.0000	0.0000	27.0929	0.0000	
7404154.							
1234.	0.000	0.0000	0.0000	0.0000	27.0929	0.0000	
7404154.							
1251.	0.000	0.0000	0.0000	0.0000	27.0929	0.0000	
7404154.							
1268.	0.000	0.0000	0.0000	0.0000	27.0929	0.0000	
7404154.							
1284.	0.000	0.0000	0.0000	0.0000	27.0929	0.0000	
7404154.							
1301.	0.000	0.0000	0.0000	0.0000	27.0929	0.0000	
7404154.							
1318.	0.000	0.0000	0.0000	0.0000	27.0929	0.0000	
7404154.							
1335.	0.000	0.0000	0.0000	0.0000	27.0929	0.0000	
7404154.							
1352.	0.000	0.0000	0.0000	0.0000	27.0929	0.0000	
7404154.							
1369.	0.000	0.0000	0.0000	0.0000	27.0929	0.0000	
1.0911E+07							
1386.	0.000	0.0000	0.0000	0.0000	27.0929	0.0000	
1.0911E+07							
1403.	0.000	0.0000	0.0000	0.0000	27.0929	0.0000	
1.0911E+07							
1420.	0.000	0.0000	0.0000	0.0000	27.0929	0.0000	

24 inch pipe - stratum 5 through 7.1po

1.0911E+07						
1436.	0.000	0.0000	0.0000	0.0000	27.0929	0.0000
1.0911E+07						
1453.	0.000	0.0000	0.0000	0.0000	27.0929	0.0000
1.0911E+07						
1470.	0.000	0.0000	0.0000	0.0000	27.0929	0.0000
1.0911E+07						
1487.	0.000	0.0000	0.0000	0.0000	27.0929	0.0000
1.0911E+07						
1504.	0.000	0.0000	0.0000	0.0000	27.0929	0.0000
1.0911E+07						
1521.	0.000	0.0000	0.0000	0.0000	27.0929	0.0000
1.0911E+07						
1538.	0.000	0.0000	0.0000	0.0000	27.0929	0.0000
1.0911E+07						
1555.	0.000	0.0000	0.0000	0.0000	27.0929	0.0000
1.0911E+07						
1572.	0.000	0.0000	0.0000	0.0000	27.0929	0.0000
1.0911E+07						
1589.	0.000	0.0000	0.0000	0.0000	27.0929	0.0000
1.0911E+07						
1605.	0.000	0.0000	0.0000	0.0000	27.0929	0.0000
1.0911E+07						
1622.	0.000	0.0000	0.0000	0.0000	27.0929	0.0000
1.0911E+07						
1639.	0.000	0.0000	0.0000	0.0000	27.0929	0.0000
1.0911E+07						
1656.	0.000	0.0000	0.0000	0.0000	27.0929	0.0000
1.0911E+07						
1673.	0.000	0.0000	0.0000	0.0000	27.0929	0.0000
1.0911E+07						
1690.	0.000	0.0000	0.0000	0.0000	27.0929	0.0000
5455523.						

Output Verification:

Computed forces and moments are within specified convergence limits.

Output Summary for Load Case No. 1:

Pile-head deflection = .21218486 in
 Computed slope at pile head = -.00806230
 Maximum bending moment = 18034.38569 lbs-in
 Maximum shear force = 1000.00000 lbs
 Depth of maximum bending moment = 16.90000000 in
 Depth of maximum shear force = 0.00000 in
 Number of iterations = 12
 Number of zero deflection points = 45

 Summary of Pile Response(s)

Definition of Symbols for Pile-Head Loading Conditions:

Type 1 = Shear and Moment, y = pile-head displacement in
 Type 2 = Shear and Slope, M = Pile-head Moment lbs-in
 Type 3 = Shear and Rot. Stiffness, V = Pile-head Shear Force lbs
 Page 14

24 inch pipe - stratum 5 through 7.1po

Type 4 = Deflection and Moment,
Type 5 = Deflection and Slope,

S = Pile-head Slope, radians
R = Rot. Stiffness of Pile-head in-lbs/rad

Load Type	Pile-Head Condition 1	Pile-Head Condition 2	Axial Load lbs	Pile-Head Deflection in	Maximum Moment in-lbs	Maximum Shear lbs
1	v= 1000.000	M= 1000.000	1000.0000	.2121849	18034.3857	1000.0000

The analysis ended normally.

24 inch pipe - stratum 8 through 10.lpo

LPILE Plus for Windows, Version 5.0 (5.0.30)

Analysis of Individual Piles and Drilled Shafts
Subjected to Lateral Loading Using the p-y Method

(c) 1985-2007 by Ensoft, Inc.
All Rights Reserved

This program is licensed to:

DJI
Eustis

Path to file locations: U:\sys\WPDATA\Projects\20749\Piles\LPile\
Name of input data file: 24 inch pipe - stratum 8 through 10.lpd
Name of output file: 24 inch pipe - stratum 8 through 10.lpo
Name of plot output file: 24 inch pipe - stratum 8 through 10.lpp
Name of runtime file: 24 inch pipe - stratum 8 through 10.lpr

Time and Date of Analysis

Date: November 9, 2009 Time: 17:55:57

Problem Title

EE20749 - St. Mary Floodgate Structure at Franklin Drainage Canal

Program Options

Units Used in Computations - US Customary Units: Inches, Pounds

Basic Program Options:

Analysis Type 1:

- Computation of Lateral Pile Response Using User-specified Constant EI

Computation Options:

- Only internally-generated p-y curves used in analysis
- Analysis does not use p-y multipliers (individual pile or shaft action only)
- Analysis assumes no shear resistance at pile tip
- Analysis for fixed-length pile or shaft only
- No computation of foundation stiffness matrix elements
- Output pile response for full length of pile
- Analysis assumes no soil movements acting on pile
- Additional p-y curves computed at specified depths

Solution Control Parameters:

- Number of pile increments = 100
- Maximum number of iterations allowed = 100

24 inch pipe - stratum 8 through 10.lpo

- Deflection tolerance for convergence = 1.0000E-05 in
- Maximum allowable deflection = 1.0000E+02 in

Printing Options:

- Values of pile-head deflection, bending moment, shear force, and soil reaction are printed for full length of pile.
- Printing Increment (spacing of output points) = 1

Pile Structural Properties and Geometry

Pile Length = 1690.00 in
Depth of ground surface below top of pile = .00 in
Slope angle of ground surface = .00 deg.

Structural properties of pile defined using 2 points

Point	Depth X in	Pile Diameter in	Moment of Inertia in**4	Pile Area Sq.in	Modulus of Elasticity lbs/Sq.in
1	0.0000	24.00000000	2549.4000	36.9100	30000.00000
2	1690.0000	24.00000000	2549.4000	36.9100	30000.00000

Soil and Rock Layering Information

The soil profile is modelled using 10 layers

Layer 1 is silt with cohesion and friction
Distance from top of pile to top of layer = .000 in
Distance from top of pile to bottom of layer = 36.000 in
p-y subgrade modulus k for top of soil layer = 55.600 lbs/in**3
p-y subgrade modulus k for bottom of layer = 55.600 lbs/in**3

Layer 2 is soft clay, p-y criteria by Matlock, 1970
Distance from top of pile to top of layer = 36.000 in
Distance from top of pile to bottom of layer = 180.000 in

Layer 3 is silt with cohesion and friction
Distance from top of pile to top of layer = 180.000 in
Distance from top of pile to bottom of layer = 204.000 in
p-y subgrade modulus k for top of soil layer = 55.600 lbs/in**3
p-y subgrade modulus k for bottom of layer = 55.600 lbs/in**3

Layer 4 is soft clay, p-y criteria by Matlock, 1970
Distance from top of pile to top of layer = 204.000 in
Distance from top of pile to bottom of layer = 276.000 in

Layer 5 is soft clay, p-y criteria by Matlock, 1970
Distance from top of pile to top of layer = 276.000 in
Distance from top of pile to bottom of layer = 516.000 in

Layer 6 is stiff clay without free water
Distance from top of pile to top of layer = 516.000 in
Distance from top of pile to bottom of layer = 612.000 in

Layer 7 is stiff clay without free water
Distance from top of pile to top of layer = 612.000 in

24 inch pipe - stratum 8 through 10.lpo
 Distance from top of pile to bottom of layer = 828.000 in

Layer 8 is stiff clay without free water
 Distance from top of pile to top of layer = 828.000 in
 Distance from top of pile to bottom of layer = 1212.000 in

Layer 9 is stiff clay without free water
 Distance from top of pile to top of layer = 1212.000 in
 Distance from top of pile to bottom of layer = 1356.000 in

Layer 10 is stiff clay without free water
 Distance from top of pile to top of layer = 1356.000 in
 Distance from top of pile to bottom of layer = 1692.000 in

(Depth of lowest layer extends 2.00 in below pile tip)

 Effective Unit Weight of Soil vs. Depth

Distribution of effective unit weight of soil with depth
 is defined using 20 points

Point No.	Depth X in	Eff. Unit Weight lbs/in**3
1	.00	.03160
2	36.00	.03160
3	36.00	.03330
4	180.00	.03330
5	180.00	.03160
6	204.00	.03160
7	204.00	.03480
8	276.00	.03480
9	276.00	.03250
10	516.00	.03250
11	516.00	.03620
12	612.00	.03620
13	612.00	.03550
14	828.00	.03550
15	828.00	.03110
16	1212.00	.03110
17	1212.00	.03040
18	1356.00	.03040
19	1356.00	.03450
20	1692.00	.03450

 Shear strength of soils

Distribution of shear strength parameters with depth
 defined using 20 points

Point No.	Depth X in	Cohesion c lbs/in**2	Angle of Friction Deg.	E50 or k_rm	RQD %
1	.000	1.38890	15.00	.02000	.0
2	36.000	1.38890	15.00	.02000	.0

24 inch pipe - stratum 8 through 10.1po						
3	36.000	2.20140	.00	.02000	.0	
4	180.000	2.20140	.00	.02000	.0	
5	180.000	1.38890	15.00	.02000	.0	
6	204.000	1.38890	15.00	.02000	.0	
7	204.000	3.12500	.00	.02000	.0	
8	276.000	3.12500	.00	.02000	.0	
9	276.000	4.16670	.00	.01000	.0	
10	516.000	7.63890	.00	.00700	.0	
11	516.000	7.63890	.00	.00700	.0	
12	612.000	7.63890	.00	.00700	.0	
13	612.000	9.59030	.00	.00700	.0	
14	828.000	9.59030	.00	.00700	.0	
15	828.000	7.84720	.00	.00700	.0	
16	1212.000	7.84720	.00	.00700	.0	
17	1212.000	10.59030	.00	.00700	.0	
18	1356.000	10.59030	.00	.00700	.0	
19	1356.000	14.34720	.00	.00500	.0	
20	1692.000	14.34720	.00	.00500	.0	

Notes:

- (1) Cohesion = uniaxial compressive strength for rock materials.
- (2) Values of E50 are reported for clay strata.
- (3) Default values will be generated for E50 when input values are 0.
- (4) RQD and k_{rm} are reported only for weak rock strata.

Loading Type

Cyclic loading criteria was used for computation of p-y curves

Number of cycles of loading = 1000.

Pile-head Loading and Pile-head Fixity Conditions

Number of loads specified = 1

Load Case Number 1

Pile-head boundary conditions are Shear and Moment (BC Type 1)

Shear force at pile head = 1000.000 lbs
Bending moment at pile head = 1000.000 in-lbs
Axial load at pile head = 1000.000 lbs

Non-zero moment at pile head for this load case indicates the pile-head may rotate under the applied pile-head loading, but is not a free-head (zero moment) condition.

Output of p-y Curves at Specified Depths

24 inch pipe - stratum 8 through 10.1po

p-y curves are generated and printed for verification at 8 depths.

Depth No.	Depth Below Pile Head in	Depth Below Ground Surface in
1	840.000	840.000
2	1020.000	1020.000
3	1200.000	1200.000
4	1224.000	1224.000
5	1284.000	1284.000
6	1344.000	1344.000
7	1524.000	1524.000
8	1690.000	1690.000

Depth of ground surface below top of pile = .00 in

p-y Curve Computed Using Cyclic Criteria for Stiff Clay without Free Water

Soil Layer Number = 8
 Depth below pile head = 840.000 in
 Depth below ground surface = 840.000 in
 Equivalent Depth = 628.800 in
 Diameter = 24.000 in
 Undrained cohesion, c = 7.84720 lbs/in**2
 Average Eff. Unit Weight = .03394 lbs/in**3
 Epsilon-50 = .00700
 Pct = 3544.419 lbs/in
 Pcd = 1694.995 lbs/in
 Pu = 1694.995 lbs/in
 y50 = .420 in
 p-multiplier = 1.00000
 y-multiplier = 1.00000
 Number of cycles of loading = 1000.

y, in	p, lbs/in
0.0000	0.0000
6.7200E-05	73.6850
.0003360	110.1847
.0006720	131.0325
.0033600	195.9393
.0067200	233.0124
.0336000	348.4347
.0672000	414.3611
.1680000	521.0315
.3360000	619.6143
.5040000	685.7160
.6720000	736.8498
1.6800	926.5396
3.3600	1101.8474
6.7200	1310.3248
15.1200	1604.8136
23.5200	1694.9952

p-y Curve Computed Using Cyclic Criteria for Stiff Clay without Free Water

Soil Layer Number = 8
 Depth below pile head = 1020.000 in
 Depth below ground surface = 1020.000 in

24 inch pipe - stratum 8 through 10.lpo

Equivalent Depth = 808.800 in
 Diameter = 24.000 in
 Undrained cohesion, c = 7.84720 lbs/in**2
 Average Eff. Unit Weight = .03344 lbs/in**3
 Epsilon-50 = .00700
 Pct = 4387.563 lbs/in
 Pcd = 1694.995 lbs/in
 Pu = 1694.995 lbs/in
 y50 = .420 in
 p-multiplier = 1.00000
 y-multiplier = 1.00000
 Number of cycles of loading = 1000.

y, in	p, lbs/in
0.0000	0.0000
6.7200E-05	73.6850
.0003360	110.1847
.0006720	131.0325
.0033600	195.9393
.0067200	233.0124
.0336000	348.4347
.0672000	414.3611
.1680000	521.0315
.3360000	619.6143
.5040000	685.7160
.6720000	736.8498
1.6800	926.5396
3.3600	1101.8474
6.7200	1310.3248
15.1200	1604.8136
23.5200	1694.9952

p-y Curve Computed Using Cyclic Criteria for Stiff Clay without Free Water

Soil Layer Number = 8
 Depth below pile head = 1200.000 in
 Depth below ground surface = 1200.000 in
 Equivalent Depth = 988.800 in
 Diameter = 24.000 in
 Undrained cohesion, c = 7.84720 lbs/in**2
 Average Eff. Unit Weight = .03309 lbs/in**3
 Epsilon-50 = .00700
 Pct = 5229.944 lbs/in
 Pcd = 1694.995 lbs/in
 Pu = 1694.995 lbs/in
 y50 = .420 in
 p-multiplier = 1.00000
 y-multiplier = 1.00000
 Number of cycles of loading = 1000.

y, in	p, lbs/in
0.0000	0.0000
6.7200E-05	73.6850
.0003360	110.1847
.0006720	131.0325
.0033600	195.9393
.0067200	233.0124
.0336000	348.4347
.0672000	414.3611
.1680000	521.0315

24 inch pipe - stratum 8 through 10.1po

.3360000	619.6143
.5040000	685.7160
.6720000	736.8498
1.6800	926.5396
3.3600	1101.8474
6.7200	1310.3248
15.1200	1604.8136
23.5200	1694.9952

p-y Curve Computed Using Cyclic Criteria for Stiff Clay without Free Water

Soil Layer Number	=	9
Depth below pile head	=	1224.000 in
Depth below ground surface	=	1224.000 in
Equivalent Depth	=	778.097 in
Diameter	=	24.000 in
Undrained cohesion, c	=	10.59030 lbs/in**2
Average Eff. Unit Weight	=	.03305 lbs/in**3
Epsilon-50	=	.00700
Pct	=	5499.734 lbs/in
Pcd	=	2287.505 lbs/in
Pu	=	2287.505 lbs/in
y50	=	.420 in
p-multiplier	=	1.00000
y-multiplier	=	1.00000
Number of cycles of loading	=	1000.

y, in	p, lbs/in
0.0000	0.0000
6.7200E-05	99.4426
.0003360	148.7014
.0006720	176.8367
.0033600	264.4326
.0067200	314.4651
.0336000	470.2351
.0672000	559.2069
.1680000	703.1654
.3360000	836.2093
.5040000	925.4177
.6720000	994.4261
1.6800	1250.4246
3.3600	1487.0138
6.7200	1768.3674
15.1200	2165.7989
23.5200	2287.5048

p-y Curve Computed Using Cyclic Criteria for Stiff Clay without Free Water

Soil Layer Number	=	9
Depth below pile head	=	1284.000 in
Depth below ground surface	=	1284.000 in
Equivalent Depth	=	838.097 in
Diameter	=	24.000 in
Undrained cohesion, c	=	10.59030 lbs/in**2
Average Eff. Unit Weight	=	.03292 lbs/in**3
Epsilon-50	=	.00700
Pct	=	5862.542 lbs/in

24 inch pipe - stratum 8 through 10.lpo

Pcd = 2287.505 lbs/in
 Pu = 2287.505 lbs/in
 y50 = .420 in
 p-multiplier = 1.00000
 y-multiplier = 1.00000
 Number of cycles of loading = 1000.

y, in	p, lbs/in
0.0000	0.0000
6.7200E-05	99.4426
.0003360	148.7014
.0006720	176.8367
.0033600	264.4326
.0067200	314.4651
.0336000	470.2351
.0672000	559.2069
.1680000	703.1654
.3360000	836.2093
.5040000	925.4177
.6720000	994.4261
1.6800	1250.4246
3.3600	1487.0138
6.7200	1768.3674
15.1200	2165.7989
23.5200	2287.5048

p-y Curve Computed Using Cyclic Criteria for Stiff Clay without Free Water

Soil Layer Number = 9
 Depth below pile head = 1344.000 in
 Depth below ground surface = 1344.000 in
 Equivalent Depth = 898.097 in
 Diameter = 24.000 in
 Undrained cohesion, c = 10.59030 lbs/in**2
 Average Eff. Unit Weight = .03281 lbs/in**3
 Epsilon-50 = .00700
 Pct = 6225.232 lbs/in
 Pcd = 2287.505 lbs/in
 Pu = 2287.505 lbs/in
 y50 = .420 in
 p-multiplier = 1.00000
 y-multiplier = 1.00000
 Number of cycles of loading = 1000.

y, in	p, lbs/in
0.0000	0.0000
6.7200E-05	99.4426
.0003360	148.7014
.0006720	176.8367
.0033600	264.4326
.0067200	314.4651
.0336000	470.2351
.0672000	559.2069
.1680000	703.1654
.3360000	836.2093
.5040000	925.4177
.6720000	994.4261
1.6800	1250.4246
3.3600	1487.0138
6.7200	1768.3674

24 inch pipe - stratum 8 through 10.lpo
 15.1200 2165.7989
 23.5200 2287.5048

p-y Curve Computed Using Cyclic Criteria for Stiff Clay without Free Water

Soil Layer Number = 10
 Depth below pile head = 1524.000 in
 Depth below ground surface = 1524.000 in
 Equivalent Depth = 861.118 in
 Diameter = 24.000 in
 Undrained cohesion, c = 14.34720 lbs/in**2
 Average Eff. Unit Weight = .03298 lbs/in**3
 Epsilon-50 = .00500
 Pct = 7891.833 lbs/in
 Pcd = 3098.995 lbs/in
 Pu = 3098.995 lbs/in
 y50 = .300 in
 p-multiplier = 1.00000
 y-multiplier = 1.00000
 Number of cycles of loading = 1000.

y, in	p, lbs/in
0.0000	0.0000
4.8000E-05	134.7198
.0002400	201.4531
.0004800	239.5694
.0024000	358.2399
.0048000	426.0214
.0240000	637.0505
.0480000	757.5850
.1200000	952.6128
.2400000	1132.8539
.3600000	1253.7089
.4800000	1347.1979
1.2000	1694.0117
2.4000	2014.5307
4.8000	2395.6943
10.8000	2934.1143
16.8000	3098.9952

p-y Curve Computed Using Cyclic Criteria for Stiff Clay without Free Water

Soil Layer Number = 10
 Depth below pile head = 1690.000 in
 Depth below ground surface = 1690.000 in
 Equivalent Depth = 1027.118 in
 Diameter = 24.000 in
 Undrained cohesion, c = 14.34720 lbs/in**2
 Average Eff. Unit Weight = .03313 lbs/in**3
 Epsilon-50 = .00500
 Pct = 9217.718 lbs/in
 Pcd = 3098.995 lbs/in
 Pu = 3098.995 lbs/in
 y50 = .300 in
 p-multiplier = 1.00000
 y-multiplier = 1.00000
 Number of cycles of loading = 1000.

24 inch pipe - stratum 8 through 10.1po

y, in	p, lbs/in
0.0000	0.0000
4.8000E-05	134.7198
.0002400	201.4531
.0004800	239.5694
.0024000	358.2399
.0048000	426.0214
.0240000	637.0505
.0480000	757.5850
.1200000	952.6128
.2400000	1132.8539
.3600000	1253.7089
.4800000	1347.1979
1.2000	1694.0117
2.4000	2014.5307
4.8000	2395.6943
10.8000	2934.1143
16.8000	3098.9952

 Computed Values of Load Distribution and Deflection
 for Lateral Loading for Load Case Number 1

Pile-head boundary conditions are Shear and Moment (BC Type 1)
 Specified shear force at pile head = 1000.000 lbs
 Specified moment at pile head = 1000.000 in-lbs
 Specified axial load at pile head = 1000.000 lbs

Non-zero moment for this load case indicates the pile-head may rotate under the applied pile-head loading, but is not a free-head (zero moment) condition.

Depth Es*h X F/L in lbs/in	Deflect. y in	Moment M lbs-in	Shear V lbs	Slope S Rad.	Total Stress lbs/in**2	Soil Res. p lbs/in
0.000	.212185	1000.0000	1000.0000	-.0080623	31.7999	0.0000
0.0000						
16.900	.077799	18034.3857	382.2779	-.0059593	111.9806	-73.1032
15879.9160						
33.800	.010760	14122.4169	-406.3130	-.0024065	93.5670	-20.2211
31759.8320						
50.700	-.003541	4382.3478	-423.3863	-.0003620	47.7206	18.2006
86862.5170						
67.600	-.001477	-175.8028	-139.8727	.0001027	27.9204	15.3513
175638.						
84.500	-6.96E-05	-348.8207	4.1799	4.4746E-05	28.7348	1.6964
411920.						
101.400	3.53E-05	-36.0337	10.5102	2.2255E-06	27.2625	-.9472321
453568.						
118.300	5.62E-06	6.3489	1.1136	-1.0542E-06	27.1228	-.1647877
495215.						
135.200	-3.38E-07	1.6427	-.1881220	-1.7126E-07	27.1007	.0107338

24 inch pipe - stratum 8 through 10.lpo

536862.						
152.100	-1.65E-07	-.0038687	-.0497223	9.8084E-09	27.0929	.0056449
578509.						
169.000	-6.37E-09	-.0382154	-5.9949E-05	5.1588E-09	27.0931	.0002323
616768.						
185.900	9.46E-09	-.0060694	.0011643	2.6610E-10	27.0930	-8.7423E-05
156111.						
202.800	2.63E-09	.0011303	.0001996	-2.7958E-10	27.0929	-2.6752E-05
171991.						
219.700	1.43E-11	.0006850	-3.2762E-05	-7.9021E-11	27.0929	-7.4038E-07
875533.						
236.600	-4.22E-11	2.5630E-05	-2.0550E-05	-5.1022E-13	27.0929	2.1856E-06
875533.						
253.500	-2.95E-12	-9.5814E-06	-7.8797E-07	1.2629E-12	27.0929	1.5305E-07
875533.						
270.400	4.99E-13	-1.0456E-06	2.8674E-07	8.8822E-14	27.0929	-2.5863E-08
875533.						
287.300	4.80E-14	1.0723E-07	3.1341E-08	-1.4854E-14	27.0929	-4.3606E-09
1535789.						
304.200	-2.84E-15	1.4231E-08	-3.1881E-09	-1.4349E-15	27.0929	2.7428E-10
1634263.						
321.100	-5.14E-16	-4.8268E-10	-4.2509E-10	8.4108E-17	27.0929	5.2711E-11
1734362.						
338.000	6.57E-18	-1.3993E-10	1.4282E-11	1.5320E-17	27.0929	-7.1360E-13
1836160.						
354.900	4.21E-18	-4.7416E-13	4.1717E-12	-1.9210E-19	27.0929	-4.8285E-13
1939740.						
371.800	7.50E-20	1.0790E-12	1.4925E-14	-1.2528E-19	27.0929	-9.0806E-15
2045190.						
388.700	-2.76E-20	3.4532E-14	-3.2122E-14	-2.2567E-21	27.0929	3.5130E-15
2152606.						
405.600	-1.24E-21	-6.6816E-15	-1.0329E-15	8.2028E-22	27.0929	1.6618E-16
2262088.						
422.500	1.45E-22	-4.0738E-16	1.9869E-16	3.7062E-23	27.0929	-2.0432E-17
2373749.						
439.400	1.12E-23	3.2813E-17	1.2146E-17	-4.3213E-24	27.0929	-1.6442E-18
2487708.						
456.300	-5.94E-25	3.2886E-18	-9.7460E-19	-3.3271E-25	27.0929	9.1488E-20
2604096.						
473.200	0.000	-1.1781E-19	-9.7904E-20	0.0000	27.0929	1.2264E-20
2723054.						
490.100	0.000	-2.1109E-20	3.4934E-21	0.0000	27.0929	-2.6427E-22
2844737.						
507.000	0.000	1.9234E-22	6.2783E-22	0.0000	27.0929	-7.4854E-23
2969314.						
523.900	0.000	1.1356E-22	-5.6807E-24	0.0000	27.0929	-1.1760E-25
5340698.						
540.800	0.000	7.5843E-25	-3.3692E-24	0.0000	27.0929	3.9116E-25
5340698.						
557.700	0.000	-3.2226E-25	0.0000	0.0000	27.0929	0.0000
5340698.						
574.600	0.000	0.0000	0.0000	0.0000	27.0929	0.0000
5340698.						
591.500	0.000	0.0000	0.0000	0.0000	27.0929	0.0000
5340698.						
608.400	0.000	0.0000	0.0000	0.0000	27.0929	0.0000
5340698.						
625.300	0.000	0.0000	0.0000	0.0000	27.0929	0.0000
6705010.						
642.200	0.000	0.0000	0.0000	0.0000	27.0929	0.0000
6705010.						
659.100	0.000	0.0000	0.0000	0.0000	27.0929	0.0000
6705010.						

24 inch pipe - stratum 8 through 10.1po

676.000	0.000	0.0000	0.0000	0.0000	27.0929	0.0000
6705010.						
692.900	0.000	0.0000	0.0000	0.0000	27.0929	0.0000
6705010.						
709.800	0.000	0.0000	0.0000	0.0000	27.0929	0.0000
6705010.						
726.700	0.000	0.0000	0.0000	0.0000	27.0929	0.0000
6705010.						
743.600	0.000	0.0000	0.0000	0.0000	27.0929	0.0000
6705010.						
760.500	0.000	0.0000	0.0000	0.0000	27.0929	0.0000
6705010.						
777.400	0.000	0.0000	0.0000	0.0000	27.0929	0.0000
6705010.						
794.300	0.000	0.0000	0.0000	0.0000	27.0929	0.0000
6705010.						
811.200	0.000	0.0000	0.0000	0.0000	27.0929	0.0000
6705010.						
828.100	0.000	0.0000	0.0000	0.0000	27.0929	0.0000
5486330.						
845.000	0.000	0.0000	0.0000	0.0000	27.0929	0.0000
5486330.						
861.900	0.000	0.0000	0.0000	0.0000	27.0929	0.0000
5486330.						
878.800	0.000	0.0000	0.0000	0.0000	27.0929	0.0000
5486330.						
895.700	0.000	0.0000	0.0000	0.0000	27.0929	0.0000
5486330.						
912.600	0.000	0.0000	0.0000	0.0000	27.0929	0.0000
5486330.						
929.500	0.000	0.0000	0.0000	0.0000	27.0929	0.0000
5486330.						
946.400	0.000	0.0000	0.0000	0.0000	27.0929	0.0000
5486330.						
963.300	0.000	0.0000	0.0000	0.0000	27.0929	0.0000
5486330.						
980.200	0.000	0.0000	0.0000	0.0000	27.0929	0.0000
5486330.						
997.100	0.000	0.0000	0.0000	0.0000	27.0929	0.0000
5486330.						
1014.	0.000	0.0000	0.0000	0.0000	27.0929	0.0000
5486330.						
1031.	0.000	0.0000	0.0000	0.0000	27.0929	0.0000
5486330.						
1048.	0.000	0.0000	0.0000	0.0000	27.0929	0.0000
5486330.						
1065.	0.000	0.0000	0.0000	0.0000	27.0929	0.0000
5486330.						
1082.	0.000	0.0000	0.0000	0.0000	27.0929	0.0000
5486330.						
1099.	0.000	0.0000	0.0000	0.0000	27.0929	0.0000
5486330.						
1115.	0.000	0.0000	0.0000	0.0000	27.0929	0.0000
5486330.						
1132.	0.000	0.0000	0.0000	0.0000	27.0929	0.0000
5486330.						
1149.	0.000	0.0000	0.0000	0.0000	27.0929	0.0000
5486330.						
1166.	0.000	0.0000	0.0000	0.0000	27.0929	0.0000
5486330.						
1183.	0.000	0.0000	0.0000	0.0000	27.0929	0.0000
5486330.						
1200.	0.000	0.0000	0.0000	0.0000	27.0929	0.0000

24 inch pipe - stratum 8 through 10.1po

5486330.						
1217.	0.000	0.0000	0.0000	0.0000	27.0929	0.0000
7404154.						
1234.	0.000	0.0000	0.0000	0.0000	27.0929	0.0000
7404154.						
1251.	0.000	0.0000	0.0000	0.0000	27.0929	0.0000
7404154.						
1268.	0.000	0.0000	0.0000	0.0000	27.0929	0.0000
7404154.						
1284.	0.000	0.0000	0.0000	0.0000	27.0929	0.0000
7404154.						
1301.	0.000	0.0000	0.0000	0.0000	27.0929	0.0000
7404154.						
1318.	0.000	0.0000	0.0000	0.0000	27.0929	0.0000
7404154.						
1335.	0.000	0.0000	0.0000	0.0000	27.0929	0.0000
7404154.						
1352.	0.000	0.0000	0.0000	0.0000	27.0929	0.0000
7404154.						
1369.	0.000	0.0000	0.0000	0.0000	27.0929	0.0000
1.0911E+07						
1386.	0.000	0.0000	0.0000	0.0000	27.0929	0.0000
1.0911E+07						
1403.	0.000	0.0000	0.0000	0.0000	27.0929	0.0000
1.0911E+07						
1420.	0.000	0.0000	0.0000	0.0000	27.0929	0.0000
1.0911E+07						
1436.	0.000	0.0000	0.0000	0.0000	27.0929	0.0000
1.0911E+07						
1453.	0.000	0.0000	0.0000	0.0000	27.0929	0.0000
1.0911E+07						
1470.	0.000	0.0000	0.0000	0.0000	27.0929	0.0000
1.0911E+07						
1487.	0.000	0.0000	0.0000	0.0000	27.0929	0.0000
1.0911E+07						
1504.	0.000	0.0000	0.0000	0.0000	27.0929	0.0000
1.0911E+07						
1521.	0.000	0.0000	0.0000	0.0000	27.0929	0.0000
1.0911E+07						
1538.	0.000	0.0000	0.0000	0.0000	27.0929	0.0000
1.0911E+07						
1555.	0.000	0.0000	0.0000	0.0000	27.0929	0.0000
1.0911E+07						
1572.	0.000	0.0000	0.0000	0.0000	27.0929	0.0000
1.0911E+07						
1589.	0.000	0.0000	0.0000	0.0000	27.0929	0.0000
1.0911E+07						
1605.	0.000	0.0000	0.0000	0.0000	27.0929	0.0000
1.0911E+07						
1622.	0.000	0.0000	0.0000	0.0000	27.0929	0.0000
1.0911E+07						
1639.	0.000	0.0000	0.0000	0.0000	27.0929	0.0000
1.0911E+07						
1656.	0.000	0.0000	0.0000	0.0000	27.0929	0.0000
1.0911E+07						
1673.	0.000	0.0000	0.0000	0.0000	27.0929	0.0000
1.0911E+07						
1690.	0.000	0.0000	0.0000	0.0000	27.0929	0.0000
5455523.						

Output Verification:

Computed forces and moments are within specified convergence limits.

24 inch pipe - stratum 8 through 10.lpo

Output Summary for Load Case No. 1:

Pile-head deflection = .21218486 in
 Computed slope at pile head = -.00806230
 Maximum bending moment = 18034.38569 lbs-in
 Maximum shear force = 1000.00000 lbs
 Depth of maximum bending moment = 16.90000000 in
 Depth of maximum shear force = 0.00000 in
 Number of iterations = 12
 Number of zero deflection points = 45

 Summary of Pile Response(s)

Definition of Symbols for Pile-Head Loading Conditions:

Type 1 = Shear and Moment, y = pile-head displacment in
 Type 2 = Shear and Slope, M = Pile-head Moment lbs-in
 Type 3 = Shear and Rot. Stiffness, V = Pile-head Shear Force lbs
 Type 4 = Deflection and Moment, S = Pile-head Slope, radians
 Type 5 = Deflection and Slope, R = Rot. Stiffness of Pile-head in-lbs/rad

Load Type	Pile-Head Condition 1	Pile-Head Condition 2	Axial Load lbs	Pile-Head Deflection in	Maximum Moment in-lbs	Maximum Shear lbs
1	V= 1000.000	M= 1000.000	1000.0000	.2121849	18034.3857	1000.0000

The analysis ended normally.

36 inch pipe - stratum 1 through 4.lpo

LPILE Plus for Windows, Version 5.0 (5.0.30)

Analysis of Individual Piles and Drilled Shafts
Subjected to Lateral Loading Using the p-y Method

(c) 1985-2007 by Ensoft, Inc.
All Rights Reserved

This program is licensed to:

DJI
Eustis

Path to file locations: U:\sys\WPDATA\Projects\20749\Piles\LPile\
Name of input data file: 36 inch pipe - stratum 1 through 4.lpd
Name of output file: 36 inch pipe - stratum 1 through 4.lpo
Name of plot output file: 36 inch pipe - stratum 1 through 4.lpp
Name of runtime file: 36 inch pipe - stratum 1 through 4.lpr

Time and Date of Analysis

Date: November 9, 2009 Time: 17:40:35

Problem Title

EE20749 - St. Mary Floodgate Structure at Franklin Drainage Canal

Program Options

Units Used in Computations - US Customary Units: Inches, Pounds

Basic Program Options:

Analysis Type 1:

- Computation of Lateral Pile Response Using User-specified Constant EI

Computation Options:

- Only internally-generated p-y curves used in analysis
- Analysis does not use p-y multipliers (individual pile or shaft action only)
- Analysis assumes no shear resistance at pile tip
- Analysis for fixed-length pile or shaft only
- No computation of foundation stiffness matrix elements
- Output pile response for full length of pile
- Analysis assumes no soil movements acting on pile
- Additional p-y curves computed at specified depths

Solution Control Parameters:

- Number of pile increments = 100
- Maximum number of iterations allowed = 100

36 inch pipe - stratum 1 through 4.lpo

- Deflection tolerance for convergence = 1.0000E-05 in
- Maximum allowable deflection = 1.0000E+02 in

Printing Options:

- Values of pile-head deflection, bending moment, shear force, and soil reaction are printed for full length of pile.
- Printing Increment (spacing of output points) = 1

Pile Structural Properties and Geometry

Pile Length = 1690.00 in
Depth of ground surface below top of pile = .00 in
Slope angle of ground surface = .00 deg.

Structural properties of pile defined using 2 points

Point	Depth X in	Pile Diameter in	Moment of Inertia in**4	Pile Area Sq.in	Modulus of Elasticity lbs/Sq.in
1	0.0000	36.00000000	82448.0000	55.8000	30000.00000
2	1690.0000	36.00000000	82448.0000	55.8000	30000.00000

Soil and Rock Layering Information

The soil profile is modelled using 10 layers

Layer 1 is silt with cohesion and friction
Distance from top of pile to top of layer = .000 in
Distance from top of pile to bottom of layer = 36.000 in
p-y subgrade modulus k for top of soil layer = 55.600 lbs/in**3
p-y subgrade modulus k for bottom of layer = 55.600 lbs/in**3

Layer 2 is soft clay, p-y criteria by Matlock, 1970
Distance from top of pile to top of layer = 36.000 in
Distance from top of pile to bottom of layer = 180.000 in

Layer 3 is silt with cohesion and friction
Distance from top of pile to top of layer = 180.000 in
Distance from top of pile to bottom of layer = 204.000 in
p-y subgrade modulus k for top of soil layer = 55.600 lbs/in**3
p-y subgrade modulus k for bottom of layer = 55.600 lbs/in**3

Layer 4 is soft clay, p-y criteria by Matlock, 1970
Distance from top of pile to top of layer = 204.000 in
Distance from top of pile to bottom of layer = 276.000 in

Layer 5 is soft clay, p-y criteria by Matlock, 1970
Distance from top of pile to top of layer = 276.000 in
Distance from top of pile to bottom of layer = 516.000 in

Layer 6 is stiff clay without free water
Distance from top of pile to top of layer = 516.000 in
Distance from top of pile to bottom of layer = 612.000 in

Layer 7 is stiff clay without free water
Distance from top of pile to top of layer = 612.000 in

36 inch pipe - stratum 1 through 4.1po
 Distance from top of pile to bottom of layer = 828.000 in

Layer 8 is stiff clay without free water
 Distance from top of pile to top of layer = 828.000 in
 Distance from top of pile to bottom of layer = 1212.000 in

Layer 9 is stiff clay without free water
 Distance from top of pile to top of layer = 1212.000 in
 Distance from top of pile to bottom of layer = 1356.000 in

Layer 10 is stiff clay without free water
 Distance from top of pile to top of layer = 1356.000 in
 Distance from top of pile to bottom of layer = 1692.000 in

(Depth of lowest layer extends 2.00 in below pile tip)

 Effective Unit Weight of Soil vs. Depth

Distribution of effective unit weight of soil with depth
 is defined using 20 points

Point No.	Depth X in	Eff. Unit Weight lbs/in**3
1	.00	.03160
2	36.00	.03160
3	36.00	.03330
4	180.00	.03330
5	180.00	.03160
6	204.00	.03160
7	204.00	.03480
8	276.00	.03480
9	276.00	.03250
10	516.00	.03250
11	516.00	.03620
12	612.00	.03620
13	612.00	.03550
14	828.00	.03550
15	828.00	.03110
16	1212.00	.03110
17	1212.00	.03040
18	1356.00	.03040
19	1356.00	.03450
20	1692.00	.03450

 Shear Strength of Soils

Distribution of shear strength parameters with depth
 defined using 20 points

Point No.	Depth X in	Cohesion c lbs/in**2	Angle of Friction Deg.	E50 or k_rm	RQD %
1	.000	1.38890	15.00	.02000	.0
2	36.000	1.38890	15.00	.02000	.0

36 inch pipe - stratum 1 through 4.lpo					
3	36.000	2.20140	.00	.02000	.0
4	180.000	2.20140	.00	.02000	.0
5	180.000	1.38890	15.00	.02000	.0
6	204.000	1.38890	15.00	.02000	.0
7	204.000	3.12500	.00	.02000	.0
8	276.000	3.12500	.00	.02000	.0
9	276.000	4.16670	.00	.01000	.0
10	516.000	7.63890	.00	.00700	.0
11	516.000	7.63890	.00	.00700	.0
12	612.000	7.63890	.00	.00700	.0
13	612.000	9.59030	.00	.00700	.0
14	828.000	9.59030	.00	.00700	.0
15	828.000	7.84720	.00	.00700	.0
16	1212.000	7.84720	.00	.00700	.0
17	1212.000	10.59030	.00	.00700	.0
18	1356.000	10.59030	.00	.00700	.0
19	1356.000	14.34720	.00	.00500	.0
20	1692.000	14.34720	.00	.00500	.0

Notes:

- (1) Cohesion = uniaxial compressive strength for rock materials.
- (2) Values of E50 are reported for clay strata.
- (3) Default values will be generated for E50 when input values are 0.
- (4) RQD and k_{rm} are reported only for weak rock strata.

Loading Type

Cyclic loading criteria was used for computation of p-y curves

Number of cycles of loading = 1000.

Pile-head Loading and Pile-head Fixity Conditions

Number of loads specified = 1

Load Case Number 1

Pile-head boundary conditions are Shear and Moment (BC Type 1)

Shear force at pile head = 1000.000 lbs
Bending moment at pile head = 1000.000 in-lbs
Axial load at pile head = 1000.000 lbs

Non-zero moment at pile head for this load case indicates the pile-head may rotate under the applied pile-head loading, but is not a free-head (zero moment) condition.

Output of p-y Curves at Specified Depths

36 inch pipe - stratum 1 through 4.1po

p-y curves are generated and printed for verification at 8 depths.

Depth No.	Depth Below Pile Head in	Depth Below Ground Surface in
1	18.000	18.000
2	48.000	48.000
3	108.000	108.000
4	168.000	168.000
5	192.000	192.000
6	216.000	216.000
7	240.000	240.000
8	264.000	264.000

Depth of ground surface below top of pile = .00 in

Eq.	3.65	27.2809
Eq.	3.66	94.5923
Eq.	3.67	3.6595
Eq.	3.67	182.9781
Eq.	3.69	208.3493
Eq.	3.75	-3.6831
Eq.	3.76	274.5438
Eq.	3.77	.3616

p-y Curve Computed Using the Cyclic Criteria for Cemented Silt

Soil Layer Number	=	1
Depth below pile head	=	18.000 in
Depth below ground surface	=	18.000in
Equivalent Depth	=	18.000in
Pile Diameter	=	36.000in
Cohesion, c	=	1.389lbs/in**2
Angle of Friction	=	15.000 deg.
Avg. Eff. Unit Weight	=	.03160lbs/in**3
k (internal default)	=	55.600lbs/in**3
E50 (internal default)	=	.02000
A parameter	=	.93000
B parameter	=	.72000
Pu	=	182.978lbs/in
PC	=	27.281lbs/in
Number of Cycles of Loading	=	1000.
p-multiplier	=	1.00000
y-multiplier	=	1.00000
Pu,c	=	182.978lbs/in
PC,phi	=	27.281lbs/in

y, in	p, lbs/in
0.0000	0.0000
.0500000	50.0400
.1000000	100.0800
.1500000	150.1200
.2000000	200.1600
.2500000	250.2000
.3000000	300.2400
.3500000	350.2800
.4000000	352.0923
.4500000	341.0107
.5000000	331.3938
.5500000	322.9281

	36 inch pipe - stratum 1 through 4.1po
.6000000	315.3885
1.3500	208.3493
37.3500	208.3493
73.3500	208.3493
109.3500	208.3493

p-y Curve Computed Using the Soft Clay Criteria for Cyclic Loading Conditions

Soil Layer Number	=	2
Depth below pile head	=	48.000 in
Depth below ground surface	=	48.000 in
Equivalent Depth	=	40.311 in
Pile Diameter	=	36.000 in
Cohesion, c	=	2.201 lbs/in**2
Avg Eff Unit Weight	=	.03203 lbs/in**3
E50 parameter	=	.02000
Default J parameter	=	.500
Y50	=	1.80000 in
p-multiplier	=	1.00000
y-multiplier	=	1.00000
Number of cycles of loading	=	1000.
Xr	=	210.997 in

y, in	p, lbs/in
0.0000	0.0000
.0144000	34.5924
.4500000	108.9592
.9000000	137.2800
1.3500	157.1464
1.8000	172.9620
2.2500	186.3177
2.7000	197.9921
3.1500	208.4315
3.6000	217.9185
4.0500	226.6443
4.5000	234.7456
4.9500	242.3232
5.4000	249.0653
14.4000	165.1150
27.0000	47.5845
36.0000	47.5845

p-y Curve Computed Using the Soft Clay Criteria for Cyclic Loading Conditions

Soil Layer Number	=	2
Depth below pile head	=	108.000 in
Depth below ground surface	=	108.000 in
Equivalent Depth	=	100.311 in
Pile Diameter	=	36.000 in
Cohesion, c	=	2.201 lbs/in**2
Avg Eff Unit Weight	=	.03273 lbs/in**3
E50 parameter	=	.02000
Default J parameter	=	.500
Y50	=	1.80000 in
p-multiplier	=	1.00000
y-multiplier	=	1.00000
Number of cycles of loading	=	1000.

Xr = 36 inch pipe - stratum 1 through 4.1po
 = 208.636 in

y, in	p, lbs/in
0.0000	0.0000
.0144000	48.3894
.4500000	152.4171
.9000000	192.0335
1.3500	219.8234
1.8000	241.9470
2.2500	260.6295
2.7000	276.9602
3.1500	291.5633
3.6000	304.8341
4.0500	317.0403
4.5000	328.3726
4.9500	338.9725
5.4000	348.4037
14.4000	273.0318
27.0000	167.5112
36.0000	167.5112

p-y Curve Computed Using the Soft Clay Criteria for Cyclic Loading Conditions

Soil Layer Number = 2
 Depth below pile head = 168.000 in
 Depth below ground surface = 168.000 in
 Equivalent Depth = 160.311 in
 Pile Diameter = 36.000 in
 Cohesion, c = 2.201 lbs/in**2
 Avg Eff Unit Weight = .03294 lbs/in**3
 E50 parameter = .02000
 Default J parameter = .500
 Y50 = 1.80000 in
 p-multiplier = 1.00000
 y-multiplier = 1.00000
 Number of cycles of loading = 1000.
 Xr = 207.971 in

y, in	p, lbs/in
0.0000	0.0000
.0144000	62.1864
.4500000	195.8749
.9000000	246.7869
1.3500	282.5005
1.8000	310.9320
2.2500	334.9413
2.7000	355.9283
3.1500	374.6952
3.6000	391.7498
4.0500	407.4362
4.5000	421.9997
4.9500	435.6219
5.4000	447.7421
14.4000	404.9892
27.0000	345.1352
36.0000	345.1352

36 inch pipe - stratum 1 through 4.lpo

Eq. 3.66 1049.6946
 Eq. 3.67 9.3053
 Eq. 3.68 450.0036
 Eq. 3.69 1011.3902
 Eq. 3.75 -3.3115
 Eq. 3.76 1392.4062
 Eq. 3.77 .2319

p-y Curve Computed Using the Cyclic Criteria for Cemented Silt

Soil Layer Number = 3
 Depth below pile head = 192.000 in
 Depth below ground surface = 192.000in
 Equivalent Depth = 167.879in
 Pile Diameter = 36.000in
 Cohesion, c = 1.389lbs/in**2
 Angle of Friction = 15.000 deg.
 Avg. Eff. Unit Weight = .03288lbs/in**3
 k (internal default) = 55.600lbs/in**3
 E50 (internal default) = .02000
 A parameter = .88673
 B parameter = .55000
 Pu = 450.004lbs/in
 Pc = 633.095lbs/in
 Number of Cycles of Loading = 1000.
 p-multiplier = 1.00000
 y-multiplier = 1.00000
 Pu,c = 450.004lbs/in
 Pc,phi = 633.095lbs/in

y, in	p, lbs/in
0.0000	0.0000
.0500000	466.7028
.1000000	933.4057
.1500000	1400.1085
.2000000	1866.8114
.2500000	2116.2846
.3000000	2002.9181
.3500000	1911.8191
.4000000	1836.2617
.4500000	1772.0979
.5000000	1716.6036
.5500000	1667.9014
.6000000	1624.6474
1.3500	1011.3902
37.3500	1011.3902
73.3500	1011.3902
109.3500	1011.3902

p-y Curve Computed Using the Soft Clay Criteria for Cyclic Loading Conditions

Soil Layer Number = 4
 Depth below pile head = 216.000 in
 Depth below ground surface = 216.000 in
 Equivalent Depth = 299.068 in
 Pile Diameter = 36.000 in
 Cohesion, c = 3.125 lbs/in**2

36 inch pipe - stratum 1 through 4.1po

Avg Eff Unit weight = .03291 lbs/in**3
 E50 parameter = .02000
 Default J parameter = .500
 Y50 = 1.80000 in
 p-multiplier = 1.00000
 y-multiplier = 1.00000
 Number of cycles of loading = 1000.
 Xr = 245.696 in

y, in	p, lbs/in
0.0000	0.0000
.0144000	93.0917
.4500000	293.2204
.9000000	369.4346
1.3500	422.8970
1.8000	465.4584
2.2500	501.3999
2.7000	532.8169
3.1500	560.9105
3.6000	586.4408
4.0500	609.9231
4.5000	631.7242
4.9500	652.1164
5.4000	670.2601
14.4000	670.2601
27.0000	670.2601
36.0000	670.2601

p-y Curve Computed Using the Soft Clay Criteria for Cyclic Loading Conditions

Soil Layer Number = 4
 Depth below pile head = 240.000 in
 Depth below ground surface = 240.000 in
 Equivalent Depth = 323.068 in
 Pile Diameter = 36.000 in
 Cohesion, c = 3.125 lbs/in**2
 Avg Eff Unit weight = .03310 lbs/in**3
 E50 parameter = .02000
 Default J parameter = .500
 Y50 = 1.80000 in
 p-multiplier = 1.00000
 y-multiplier = 1.00000
 Number of cycles of loading = 1000.
 Xr = 245.089 in

y, in	p, lbs/in
0.0000	0.0000
.0144000	99.8484
.4500000	314.5027
.9000000	396.2486
1.3500	453.5915
1.8000	499.2420
2.2500	537.7921
2.7000	571.4894
3.1500	601.6221
3.6000	629.0055
4.0500	654.1921
4.5000	677.5756
4.9500	699.4479
5.4000	718.9085

36 inch pipe - stratum 1 through 4.lpo
 14.4000 718.9085
 27.0000 718.9085
 36.0000 718.9085

p-y Curve Computed Using the Soft Clay Criteria for Cyclic Loading Conditions

Soil Layer Number = 4
 Depth below pile head = 264.000 in
 Depth below ground surface = 264.000 in
 Equivalent Depth = 347.068 in
 Pile Diameter = 36.000 in
 Cohesion, c = 3.125 lbs/in**2
 Avg Eff Unit Weight = .03325 lbs/in**3
 E50 parameter = .02000
 Default J parameter = .500
 Y50 = 1.80000 in
 p-multiplier = 1.00000
 y-multiplier = 1.00000
 Number of cycles of loading = 1000.
 Xr = 244.595 in

y, in	p, lbs/in
0.0000	0.0000
.0144000	101.2500
.4500000	318.9175
.9000000	401.8109
1.3500	459.9586
1.8000	506.2500
2.2500	545.3413
2.7000	579.5116
3.1500	610.0673
3.6000	637.8350
4.0500	663.3752
4.5000	687.0870
4.9500	709.2662
5.4000	729.0000
14.4000	729.0000
27.0000	729.0000
36.0000	729.0000

 Computed Values of Load Distribution and Deflection
 for Lateral Loading for Load Case Number 1

Pile-head boundary conditions are Shear and Moment (BC Type 1)
 Specified shear force at pile head = 1000.000 lbs
 Specified moment at pile head = 1000.000 in-lbs
 Specified axial load at pile head = 1000.000 lbs

Non-zero moment for this load case indicates the pile-head may rotate under the applied pile-head loading, but is not a free-head (zero moment) condition.

Depth	Deflect.	Moment	Shear	Slope	Total	Soil Res.
Es*h	y	M	V	S	Stress	p
F/L	X					

in lbs/in	in	36 inch lbs-in	pipe - stratum 1 through lbs	4.1po Rad.	lbs/in**2	lbs/in
0.000	.039432	1000.0000	1000.0000	-.0008015	18.1395	0.0000
0.0000						
16.900	.025945	17913.4869	794.0008	-.0007368	21.8320	-24.3786
15879.9160						
33.800	.014526	27862.1312	357.3268	-.0005805	24.0040	-27.2988
31759.8320						
50.700	.006325	30010.7526	-99.6337	-.0003828	24.4731	-26.7794
71552.5851						
67.600	.001589	24507.4481	-484.6059	-.0001965	23.2716	-18.7795
199704.						
84.500	-.000317	13637.7140	-584.4328	-6.6185E-05	20.8985	6.9656
371707.						
101.400	-.000648	4755.8553	-394.2820	-3.3476E-06	18.9594	15.5374
405311.						
118.300	-.000430	311.0941	-168.6572	1.3963E-05	17.9891	11.1637
438916.						
135.200	-.000176	-945.2294	-32.7609	1.1796E-05	18.1275	4.9187
472520.						
152.100	-3.11E-05	-796.6227	16.6815	5.8455E-06	18.0951	.9325043
506125.						
169.000	2.17E-05	-381.5914	18.7164	1.8204E-06	18.0045	-.6916961
539729.						
185.900	3.04E-05	-164.0714	10.5616	-4.3773E-08	17.9570	-.2733670
152014.						
202.800	2.02E-05	-24.6088	6.5577	-6.8836E-07	17.9265	-.2004675
167894.						
219.700	7.12E-06	57.6011	1.9640	-5.7565E-07	17.9337	-.3431661
813994.						
236.600	7.22E-07	41.7928	-1.2445	-2.3609E-07	17.9303	-.0365285
855136.						
253.500	-8.55E-07	15.5467	-1.1788	-4.0202E-08	17.9245	.0442995
875533.						
270.400	-6.37E-07	1.9512	-.5256386	1.9576E-08	17.9216	.0329961
875533.						
287.300	-1.93E-07	-2.2206	-.0982932	1.8656E-08	17.9216	.0175773
1535789.						
304.200	-6.35E-09	-1.3718	.0554236	6.3830E-09	17.9214	.0006140
1634263.						
321.100	2.23E-08	-.3474722	.0412542	5.0951E-10	17.9212	-.0022909
1734362.						
338.000	1.09E-08	.0225894	.0119151	-6.0038E-10	17.9212	-.0011812
1836160.						
354.900	2.03E-09	.0552799	-3.4681E-05	-3.3436E-10	17.9212	-.0002330
1939740.						
371.800	-4.29E-10	.0214285	-.0015641	-7.2301E-11	17.9212	5.1967E-05
2045190.						
388.700	-4.14E-10	.0024168	-.0006792	9.1615E-12	17.9211	5.2748E-05
2152606.						
405.600	-1.20E-10	-.0015298	-9.8061E-05	1.2192E-11	17.9211	1.6030E-05
2262088.						
422.500	-2.04E-12	-.0008981	3.9817E-05	3.8973E-12	17.9211	2.8712E-07
2373749.						
439.400	1.20E-11	-.0001842	2.7353E-05	2.0012E-13	17.9211	-1.7621E-06
2487708.						
456.300	4.72E-12	2.6473E-05	6.3175E-06	-3.3859E-13	17.9211	-7.2730E-07
2604096.						
473.200	5.26E-13	2.9381E-05	-5.4466E-07	-1.4778E-13	17.9211	-8.4794E-08
2723054.						
490.100	-2.75E-13	8.0684E-06	-8.7031E-07	-1.9836E-14	17.9211	4.6257E-08

36 inch pipe - stratum 1 through 4.lpo

2844737.						
507.000	-1.44E-13	-3.4261E-08	-2.6536E-07	7.6111E-15	17.9211	2.5335E-08
2969314.						
523.900	-1.75E-14	-9.0095E-07	-5.4682E-09	4.4161E-15	17.9211	5.4210E-09
5221192.						
540.800	5.07E-15	-2.1924E-07	2.6804E-08	5.8923E-16	17.9211	-1.6018E-09
5340698.						
557.700	2.37E-15	5.0097E-09	6.9422E-09	-1.4262E-16	17.9211	-7.4871E-10
5340698.						
574.600	2.48E-16	1.5415E-08	-4.6918E-11	-7.2848E-17	17.9211	-7.8400E-11
5340698.						
591.500	-9.31E-17	3.4263E-09	-4.6089E-10	-8.4812E-18	17.9211	2.9409E-11
5340698.						
608.400	-3.86E-17	-1.6304E-10	-1.0937E-10	2.6670E-18	17.9211	1.2191E-11
5340698.						
625.300	-2.92E-18	-2.7049E-10	3.4257E-12	1.1860E-18	17.9211	1.1576E-12
6705010.						
642.200	1.51E-18	-4.7291E-11	8.1505E-12	1.0033E-19	17.9211	-5.9841E-13
6705010.						
659.100	4.73E-19	4.9974E-12	1.5065E-12	-4.4158E-20	17.9211	-1.8786E-13
6705010.						
676.000	1.57E-20	3.6314E-12	-1.3364E-13	-1.4680E-20	17.9211	-6.2465E-15
6705010.						
692.900	-2.27E-20	4.8094E-13	-1.1037E-13	-6.3086E-22	17.9211	9.0000E-15
6705010.						
709.800	-5.58E-21	-9.9099E-14	-1.5618E-14	6.7362E-22	17.9211	2.2134E-15
6705010.						
726.700	8.39E-23	-4.6966E-14	2.8040E-15	1.7462E-22	17.9211	-3.3270E-17
6705010.						
743.600	3.23E-22	-4.3307E-15	1.4391E-15	-6.2877E-25	17.9211	-1.2826E-16
6705010.						
760.500	6.26E-23	1.6745E-15	1.4544E-16	-9.7034E-24	17.9211	-2.4838E-17
6705010.						
777.400	-4.71E-24	5.8551E-16	-4.8656E-17	-1.9827E-24	17.9211	1.8678E-18
6705010.						
794.300	-4.41E-24	2.9952E-17	-1.8085E-17	1.1989E-25	17.9211	1.7501E-18
6705010.						
811.200	-6.56E-25	-2.5774E-17	-1.0991E-18	1.3416E-25	17.9211	2.6013E-19
6705010.						
828.100	1.24E-25	-7.2017E-18	7.6011E-19	0.0000	17.9211	-4.0107E-20
5486330.						
845.000	0.000	-8.3296E-20	2.2601E-19	0.0000	17.9211	-2.3100E-20
5486330.						
861.900	0.000	4.3752E-19	5.7109E-21	0.0000	17.9211	-2.9708E-21
5486330.						
878.800	0.000	1.0981E-19	-1.2991E-20	0.0000	17.9211	7.5755E-22
5486330.						
895.700	0.000	-1.5585E-21	-3.4660E-21	0.0000	17.9211	3.6966E-22
5486330.						
912.600	0.000	-7.3468E-21	-2.8494E-24	0.0000	17.9211	4.0188E-23
5486330.						
929.500	0.000	-1.6560E-21	2.1947E-22	0.0000	17.9211	-1.3879E-23
5486330.						
946.400	0.000	7.1040E-23	5.2608E-23	0.0000	17.9211	-5.8680E-24
5486330.						
963.300	0.000	1.2215E-22	-1.3725E-24	0.0000	17.9211	-5.2024E-25
5486330.						
980.200	0.000	2.4668E-23	-3.6693E-24	0.0000	17.9211	2.4843E-25
5486330.						
997.100	0.000	-1.8659E-24	-7.8935E-25	0.0000	17.9211	0.0000
5486330.						
1014.	0.000	-2.0125E-24	0.0000	0.0000	17.9211	0.0000
5486330.						

36 inch pipe - stratum 1 through 4.lpo						
1031.	0.000	-3.6225E-25	0.0000	0.0000	17.9211	0.0000
5486330.						
1048.	0.000	0.0000	0.0000	0.0000	17.9211	0.0000
5486330.						
1065.	0.000	0.0000	0.0000	0.0000	17.9211	0.0000
5486330.						
1082.	0.000	0.0000	0.0000	0.0000	17.9211	0.0000
5486330.						
1099.	0.000	0.0000	0.0000	0.0000	17.9211	0.0000
5486330.						
1115.	0.000	0.0000	0.0000	0.0000	17.9211	0.0000
5486330.						
1132.	0.000	0.0000	0.0000	0.0000	17.9211	0.0000
5486330.						
1149.	0.000	0.0000	0.0000	0.0000	17.9211	0.0000
5486330.						
1166.	0.000	0.0000	0.0000	0.0000	17.9211	0.0000
5486330.						
1183.	0.000	0.0000	0.0000	0.0000	17.9211	0.0000
5486330.						
1200.	0.000	0.0000	0.0000	0.0000	17.9211	0.0000
5486330.						
1217.	0.000	0.0000	0.0000	0.0000	17.9211	0.0000
7404154.						
1234.	0.000	0.0000	0.0000	0.0000	17.9211	0.0000
7404154.						
1251.	0.000	0.0000	0.0000	0.0000	17.9211	0.0000
7404154.						
1268.	0.000	0.0000	0.0000	0.0000	17.9211	0.0000
7404154.						
1284.	0.000	0.0000	0.0000	0.0000	17.9211	0.0000
7404154.						
1301.	0.000	0.0000	0.0000	0.0000	17.9211	0.0000
7404154.						
1318.	0.000	0.0000	0.0000	0.0000	17.9211	0.0000
7404154.						
1335.	0.000	0.0000	0.0000	0.0000	17.9211	0.0000
7404154.						
1352.	0.000	0.0000	0.0000	0.0000	17.9211	0.0000
7404154.						
1369.	0.000	0.0000	0.0000	0.0000	17.9211	0.0000
1.0911E+07						
1386.	0.000	0.0000	0.0000	0.0000	17.9211	0.0000
1.0911E+07						
1403.	0.000	0.0000	0.0000	0.0000	17.9211	0.0000
1.0911E+07						
1420.	0.000	0.0000	0.0000	0.0000	17.9211	0.0000
1.0911E+07						
1436.	0.000	0.0000	0.0000	0.0000	17.9211	0.0000
1.0911E+07						
1453.	0.000	0.0000	0.0000	0.0000	17.9211	0.0000
1.0911E+07						
1470.	0.000	0.0000	0.0000	0.0000	17.9211	0.0000
1.0911E+07						
1487.	0.000	0.0000	0.0000	0.0000	17.9211	0.0000
1.0911E+07						
1504.	0.000	0.0000	0.0000	0.0000	17.9211	0.0000
1.0911E+07						
1521.	0.000	0.0000	0.0000	0.0000	17.9211	0.0000
1.0911E+07						
1538.	0.000	0.0000	0.0000	0.0000	17.9211	0.0000
1.0911E+07						
1555.	0.000	0.0000	0.0000	0.0000	17.9211	0.0000

36 inch pipe - stratum 1 through 4.1po						
1.0911E+07						
1572.	0.000	0.0000	0.0000	0.0000	17.9211	0.0000
1.0911E+07						
1589.	0.000	0.0000	0.0000	0.0000	17.9211	0.0000
1.0911E+07						
1605.	0.000	0.0000	0.0000	0.0000	17.9211	0.0000
1.0911E+07						
1622.	0.000	0.0000	0.0000	0.0000	17.9211	0.0000
1.0911E+07						
1639.	0.000	0.0000	0.0000	0.0000	17.9211	0.0000
1.0911E+07						
1656.	0.000	0.0000	0.0000	0.0000	17.9211	0.0000
1.0911E+07						
1673.	0.000	0.0000	0.0000	0.0000	17.9211	0.0000
1.0911E+07						
1690.	0.000	0.0000	0.0000	0.0000	17.9211	0.0000
5455523.						

Output Verification:

Computed forces and moments are within specified convergence limits.

Output Summary for Load Case No. 1:

Pile-head deflection = .03943154 in
 Computed slope at pile head = -.00080146
 Maximum bending moment = 30010.75261 lbs-in
 Maximum shear force = 1000.00000 lbs
 Depth of maximum bending moment = 50.70000000 in
 Depth of maximum shear force = 0.00000 in
 Number of iterations = 9
 Number of zero deflection points = 32

 Summary of Pile Response(s)

Definition of Symbols for Pile-Head Loading Conditions:

Type 1 = Shear and Moment, y = pile-head displacement in
 Type 2 = Shear and Slope, M = Pile-head Moment lbs-in
 Type 3 = Shear and Rot. Stiffness, V = Pile-head Shear Force lbs
 Type 4 = Deflection and Moment, S = Pile-head Slope, radians
 Type 5 = Deflection and Slope, R = Rot. Stiffness of Pile-head in-lbs/rad

Load Type	Pile-Head Condition 1	Pile-Head Condition 2	Axial Load lbs	Pile-Head Deflection in	Maximum Moment in-lbs	Maximum Shear lbs
1	V= 1000.000	M= 1000.000	1000.0000	.0394315	30010.7526	1000.0000

The analysis ended normally.

36 inch pipe - stratum 5 through 7.lpo

LPILE Plus for Windows, Version 5.0 (5.0.30)

Analysis of Individual Piles and Drilled Shafts
Subjected to Lateral Loading Using the p-y Method

(c) 1985-2007 by Ensoft, Inc.
All Rights Reserved

This program is licensed to:

DJI
Eustis

Path to file locations: U:\sys\WPDATA\Projects\20749\Piles\LPile\
Name of input data file: 36 inch pipe - stratum 5 through 7.lpd
Name of output file: 36 inch pipe - stratum 5 through 7.lpo
Name of plot output file: 36 inch pipe - stratum 5 through 7.lpp
Name of runtime file: 36 inch pipe - stratum 5 through 7.lpr

Time and Date of Analysis

Date: November 9, 2009 Time: 17:42:57

Problem Title

EE20749 - St. Mary Floodgate Structure at Franklin Drainage Canal

Program Options

Units Used in Computations - US Customary Units: Inches, Pounds

Basic Program Options:

Analysis Type 1:

- Computation of Lateral Pile Response Using User-specified Constant EI

Computation Options:

- Only internally-generated p-y curves used in analysis
- Analysis does not use p-y multipliers (individual pile or shaft action only)
- Analysis assumes no shear resistance at pile tip
- Analysis for fixed-length pile or shaft only
- No computation of foundation stiffness matrix elements
- Output pile response for full length of pile
- Analysis assumes no soil movements acting on pile
- Additional p-y curves computed at specified depths

Solution Control Parameters:

- Number of pile increments = 100
- Maximum number of iterations allowed = 100

36 inch pipe - stratum 5 through 7.lpo

- Deflection tolerance for convergence = 1.0000E-05 in
- Maximum allowable deflection = 1.0000E+02 in

Printing Options:

- Values of pile-head deflection, bending moment, shear force, and soil reaction are printed for full length of pile.
- Printing Increment (spacing of output points) = 1

Pile Structural Properties and Geometry

Pile Length = 1690.00 in
Depth of ground surface below top of pile = .00 in
Slope angle of ground surface = .00 deg.

Structural properties of pile defined using 2 points

Point	Depth X in	Pile Diameter in	Moment of Inertia in**4	Pile Area Sq.in	Modulus of Elasticity lbs/Sq.in
1	0.0000	36.00000000	82448.0000	55.8000	30000.00000
2	1690.0000	36.00000000	82448.0000	55.8000	30000.00000

Soil and Rock Layering Information

The soil profile is modelled using 10 layers

Layer 1 is silt with cohesion and friction
Distance from top of pile to top of layer = .000 in
Distance from top of pile to bottom of layer = 36.000 in
p-y subgrade modulus k for top of soil layer = 55.600 lbs/in**3
p-y subgrade modulus k for bottom of layer = 55.600 lbs/in**3

Layer 2 is soft clay, p-y criteria by Matlock, 1970
Distance from top of pile to top of layer = 36.000 in
Distance from top of pile to bottom of layer = 180.000 in

Layer 3 is silt with cohesion and friction
Distance from top of pile to top of layer = 180.000 in
Distance from top of pile to bottom of layer = 204.000 in
p-y subgrade modulus k for top of soil layer = 55.600 lbs/in**3
p-y subgrade modulus k for bottom of layer = 55.600 lbs/in**3

Layer 4 is soft clay, p-y criteria by Matlock, 1970
Distance from top of pile to top of layer = 204.000 in
Distance from top of pile to bottom of layer = 276.000 in

Layer 5 is soft clay, p-y criteria by Matlock, 1970
Distance from top of pile to top of layer = 276.000 in
Distance from top of pile to bottom of layer = 516.000 in

Layer 6 is stiff clay without free water
Distance from top of pile to top of layer = 516.000 in
Distance from top of pile to bottom of layer = 612.000 in

Layer 7 is stiff clay without free water
Distance from top of pile to top of layer = 612.000 in

36 inch pipe - stratum 5 through 7.1po
 Distance from top of pile to bottom of layer = 828.000 in

Layer 8 is stiff clay without free water
 Distance from top of pile to top of layer = 828.000 in
 Distance from top of pile to bottom of layer = 1212.000 in

Layer 9 is stiff clay without free water
 Distance from top of pile to top of layer = 1212.000 in
 Distance from top of pile to bottom of layer = 1356.000 in

Layer 10 is stiff clay without free water
 Distance from top of pile to top of layer = 1356.000 in
 Distance from top of pile to bottom of layer = 1692.000 in

(Depth of lowest layer extends 2.00 in below pile tip)

 Effective Unit Weight of Soil vs. Depth

Distribution of effective unit weight of soil with depth
 is defined using 20 points

Point No.	Depth X in	Eff. Unit Weight lbs/in**3
1	.00	.03160
2	36.00	.03160
3	36.00	.03330
4	180.00	.03330
5	180.00	.03160
6	204.00	.03160
7	204.00	.03480
8	276.00	.03480
9	276.00	.03250
10	516.00	.03250
11	516.00	.03620
12	612.00	.03620
13	612.00	.03550
14	828.00	.03550
15	828.00	.03110
16	1212.00	.03110
17	1212.00	.03040
18	1356.00	.03040
19	1356.00	.03450
20	1692.00	.03450

 Shear Strength of Soils

Distribution of shear strength parameters with depth
 defined using 20 points

Point No.	Depth X in	Cohesion c lbs/in**2	Angle of Friction Deg.	E50 or k _{rm}	RQD %
1	.000	1.38890	15.00	.02000	.0
2	36.000	1.38890	15.00	.02000	.0

36 inch pipe - stratum 5 through 7.1po						
3	36.000	2.20140	.00	.02000	.0	
4	180.000	2.20140	.00	.02000	.0	
5	180.000	1.38890	15.00	.02000	.0	
6	204.000	1.38890	15.00	.02000	.0	
7	204.000	3.12500	.00	.02000	.0	
8	276.000	3.12500	.00	.02000	.0	
9	276.000	4.16670	.00	.01000	.0	
10	516.000	7.63890	.00	.00700	.0	
11	516.000	7.63890	.00	.00700	.0	
12	612.000	7.63890	.00	.00700	.0	
13	612.000	9.59030	.00	.00700	.0	
14	828.000	9.59030	.00	.00700	.0	
15	828.000	7.84720	.00	.00700	.0	
16	1212.000	7.84720	.00	.00700	.0	
17	1212.000	10.59030	.00	.00700	.0	
18	1356.000	10.59030	.00	.00700	.0	
19	1356.000	14.34720	.00	.00500	.0	
20	1692.000	14.34720	.00	.00500	.0	

Notes:

- (1) Cohesion = uniaxial compressive strength for rock materials.
- (2) Values of E50 are reported for clay strata.
- (3) Default values will be generated for E50 when input values are 0.
- (4) RQD and k_{rm} are reported only for weak rock strata.

Loading Type

Cyclic loading criteria was used for computation of p-y curves

Number of cycles of loading = 1000.

Pile-head Loading and Pile-head Fixity Conditions

Number of loads specified = 1

Load Case Number 1

Pile-head boundary conditions are Shear and Moment (BC Type 1)

Shear force at pile head = 1000.000 lbs
 Bending moment at pile head = 1000.000 in-lbs
 Axial load at pile head = 1000.000 lbs

Non-zero moment at pile head for this load case indicates the pile-head may rotate under the applied pile-head loading, but is not a free-head (zero moment) condition.

Output of p-y Curves at Specified Depths

36 inch pipe - stratum 5 through 7.1po

p-y curves are generated and printed for verification at 9 depths.

Depth No.	Depth Below Pile Head in	Depth Below Ground Surface in
1	288.000	288.000
2	396.000	396.000
3	504.000	504.000
4	528.000	528.000
5	564.000	564.000
6	600.000	600.000
7	624.000	624.000
8	720.000	720.000
9	816.000	816.000

Depth of ground surface below top of pile = .00 in

p-y Curve Computed Using the Soft Clay Criteria for Cyclic Loading Conditions

Soil Layer Number = 5
 Depth below pile head = 288.000 in
 Depth below ground surface = 288.000 in
 Equivalent Depth = 333.610 in
 Pile Diameter = 36.000 in
 Cohesion, c = 4.340 lbs/in**2
 Avg Eff Unit Weight = .03329 lbs/in**3
 E50 parameter = .00985
 Default J parameter = .500
 Y50 = .88650 in
 p-multiplier = 1.00000
 y-multiplier = 1.00000
 Number of cycles of loading = 1000.
 Xr = 278.315 in

y, in	p, lbs/in
0.0000	0.0000
.0070920	140.6260
.2216250	442.9443
.4432500	558.0748
.6648750	638.8362
.8865000	703.1302
1.1081	757.4241
1.3298	804.8832
1.5514	847.3219
1.7730	885.8886
1.9946	921.3612
2.2163	954.2945
2.4379	985.0993
2.6595	1014.0893
7.0920	1012.5076
13.2975	1012.5076
17.7300	1012.5076

p-y Curve Computed Using the Soft Clay Criteria for Cyclic Loading Conditions

Soil Layer Number = 5
 Depth below pile head = 396.000 in
 Depth below ground surface = 396.000 in
 Page 5

36 inch pipe - stratum 5 through 7.lpo

Equivalent Depth = 441.610 in
 Pile Diameter = 36.000 in
 Cohesion, c = 5.903 lbs/in**2
 Avg Eff Unit Weight = .03307 lbs/in**3
 E50 parameter = .00850
 Default J parameter = .500
 Y50 = .76500 in
 p-multiplier = 1.00000
 y-multiplier = 1.00000
 Number of cycles of loading = 1000.
 Xr = 307.822 in

y, in	p, lbs/in
0.0000	0.0000
.0061200	191.2507
.1912500	602.4020
.3825000	758.9790
.5737500	868.8141
.7650000	956.2536
.9562500	1030.0930
1.1475	1094.6371
1.3388	1152.3536
1.5300	1204.8040
1.7213	1253.0467
1.9125	1297.8358
2.1038	1339.7301
2.2950	1377.0052
6.1200	1377.0052
11.4750	1377.0052
15.3000	1377.0052

p-y Curve Computed Using the Soft Clay Criteria for Cyclic Loading Conditions

Soil Layer Number = 5
 Depth below pile head = 504.000 in
 Depth below ground surface = 504.000 in
 Equivalent Depth = 549.610 in
 Pile Diameter = 36.000 in
 Cohesion, c = 7.465 lbs/in**2
 Avg Eff Unit Weight = .03295 lbs/in**3
 E50 parameter = .00715
 Default J parameter = .500
 Y50 = .64350 in
 p-multiplier = 1.00000
 y-multiplier = 1.00000
 Number of cycles of loading = 1000.
 Xr = 327.821 in

y, in	p, lbs/in
0.0000	0.0000
.0051480	241.8754
.1608750	761.8597
.3217500	959.8831
.4826250	1098.7919
.6435000	1209.3770
.8043750	1302.7619
.9652500	1384.3911
1.1261	1457.3853
1.2870	1523.7195
1.4479	1584.7322

	36 inch pipe - stratum 5 through 7.lpo
1.6088	1641.3771
1.7696	1694.3609
1.9305	1741.5029
5.1480	1741.5029
9.6525	1741.5029
12.8700	1741.5029

p-y Curve Computed Using Cyclic Criteria for Stiff Clay without Free Water

Soil Layer Number	=	6
Depth below pile head	=	528.000 in
Depth below ground surface	=	528.000 in
Equivalent Depth	=	322.575 in
Diameter	=	36.000 in
Undrained cohesion, c	=	7.63890 lbs/in**2
Average Eff. Unit Weight	=	.03301 lbs/in**3
Epsilon-50	=	.00700
Pct	=	2440.440 lbs/in
Pcd	=	2475.004 lbs/in
Pu	=	2440.440 lbs/in
y50	=	.630 in
p-multiplier	=	1.00000
y-multiplier	=	1.00000
Number of cycles of loading	=	1000.

y, in	p, lbs/in
0.0000	0.0000
.0001008	106.0910
.0005040	158.6431
.0010080	188.6595
.0050400	282.1117
.0100800	335.4893
.0504000	501.6735
.1008000	596.5937
.2520000	750.1769
.5040000	892.1157
.7560000	987.2883
1.0080	1060.9103
2.5200	1334.0241
5.0400	1586.4309
10.0800	1886.5949
22.6800	2310.5975
35.2800	2440.4402

p-y Curve Computed Using Cyclic Criteria for Stiff Clay without Free Water

Soil Layer Number	=	6
Depth below pile head	=	564.000 in
Depth below ground surface	=	564.000 in
Equivalent Depth	=	358.575 in
Diameter	=	36.000 in
Undrained cohesion, c	=	7.63890 lbs/in**2
Average Eff. Unit Weight	=	.03322 lbs/in**3
Epsilon-50	=	.00700
Pct	=	2623.352 lbs/in
Pcd	=	2475.004 lbs/in
Pu	=	2475.004 lbs/in

36 inch pipe - stratum 5 through 7.lpo

y50 = .630 in
 p-multiplier = 1.00000
 y-multiplier = 1.00000
 Number of cycles of loading = 1000.

y, in	p, lbs/in
0.0000	0.0000
.0001008	107.5936
.0005040	160.8899
.0010080	191.3314
.0050400	286.1072
.0100800	340.2408
.0504000	508.7786
.1008000	605.0431
.2520000	760.8014
.5040000	904.7505
.7560000	1001.2710
1.0080	1075.9357
2.5200	1352.9175
5.0400	1608.8992
10.0800	1913.3143
22.6800	2343.3219
35.2800	2475.0036

p-y Curve Computed Using Cyclic Criteria for Stiff Clay without Free Water

Soil Layer Number = 6
 Depth below pile head = 600.000 in
 Depth below ground surface = 600.000 in
 Equivalent Depth = 394.575 in
 Diameter = 36.000 in
 Undrained cohesion, c = 7.63890 lbs/in**2
 Average Eff. Unit Weight = .03340 lbs/in**3
 Epsilon-50 = .00700
 Pct = 2806.443 lbs/in
 Pcd = 2475.004 lbs/in
 Pu = 2475.004 lbs/in
 y50 = .630 in
 p-multiplier = 1.00000
 y-multiplier = 1.00000
 Number of cycles of loading = 1000.

y, in	p, lbs/in
0.0000	0.0000
.0001008	107.5936
.0005040	160.8899
.0010080	191.3314
.0050400	286.1072
.0100800	340.2408
.0504000	508.7786
.1008000	605.0431
.2520000	760.8014
.5040000	904.7505
.7560000	1001.2710
1.0080	1075.9357
2.5200	1352.9175
5.0400	1608.8992
10.0800	1913.3143
22.6800	2343.3219
35.2800	2475.0036

36 inch pipe - stratum 5 through 7.lpo

p-y Curve Computed Using Cyclic Criteria for Stiff Clay without Free Water

Soil Layer Number = 7
 Depth below pile head = 624.000 in
 Depth below ground surface = 624.000 in
 Equivalent Depth = 357.264 in
 Diameter = 36.000 in
 Undrained cohesion, c = 9.59030 lbs/in**2
 Average Eff. Unit Weight = .03349 lbs/in**3
 Epsilon-50 = .00700
 Pct = 3179.625 lbs/in
 Pcd = 3107.257 lbs/in
 Pu = 3107.257 lbs/in
 y50 = .630 in
 p-multiplier = 1.00000
 y-multiplier = 1.00000
 Number of cycles of loading = 1000.

y, in	p, lbs/in
0.0000	0.0000
.0001008	135.0790
.0005040	201.9901
.0010080	240.2081
.0050400	359.1949
.0100800	427.1572
.0504000	638.7489
.1008000	759.6048
.2520000	955.1525
.5040000	1135.8741
.7560000	1257.0513
1.0080	1350.7896
2.5200	1698.5279
5.0400	2019.9015
10.0800	2402.0812
22.6800	2941.9367
35.2800	3107.2572

p-y Curve Computed Using Cyclic Criteria for Stiff Clay without Free Water

Soil Layer Number = 7
 Depth below pile head = 720.000 in
 Depth below ground surface = 720.000 in
 Equivalent Depth = 453.264 in
 Diameter = 36.000 in
 Undrained cohesion, c = 9.59030 lbs/in**2
 Average Eff. Unit Weight = .03376 lbs/in**3
 Epsilon-50 = .00700
 Pct = 3760.075 lbs/in
 Pcd = 3107.257 lbs/in
 Pu = 3107.257 lbs/in
 y50 = .630 in
 p-multiplier = 1.00000
 y-multiplier = 1.00000
 Number of cycles of loading = 1000.

y, in p, lbs/in

36 inch pipe - stratum 5 through 7.lpo

0.0000	0.0000
.0001008	135.0790
.0005040	201.9901
.0010080	240.2081
.0050400	359.1949
.0100800	427.1572
.0504000	638.7489
.1008000	759.6048
.2520000	955.1525
.5040000	1135.8741
.7560000	1257.0513
1.0080	1350.7896
2.5200	1698.5279
5.0400	2019.9015
10.0800	2402.0812
22.6800	2941.9367
35.2800	3107.2572

p-y Curve Computed Using Cyclic Criteria for Stiff Clay without Free Water

Soil Layer Number	=	7
Depth below pile head	=	816.000 in
Depth below ground surface	=	816.000 in
Equivalent Depth	=	549.264 in
Diameter	=	36.000 in
Undrained cohesion, c	=	9.59030 lbs/in**2
Average Eff. Unit Weight	=	.03396 lbs/in**3
Epsilon-50	=	.00700
Pct	=	4341.130 lbs/in
Pcd	=	3107.257 lbs/in
Pu	=	3107.257 lbs/in
y50	=	.630 in
p-multiplier	=	1.00000
y-multiplier	=	1.00000
Number of cycles of loading	=	1000.

y, in	p, lbs/in
0.0000	0.0000
.0001008	135.0790
.0005040	201.9901
.0010080	240.2081
.0050400	359.1949
.0100800	427.1572
.0504000	638.7489
.1008000	759.6048
.2520000	955.1525
.5040000	1135.8741
.7560000	1257.0513
1.0080	1350.7896
2.5200	1698.5279
5.0400	2019.9015
10.0800	2402.0812
22.6800	2941.9367
35.2800	3107.2572

36 inch pipe - stratum 5 through 7.lpo
 Computed Values of Load Distribution and Deflection
 for Lateral Loading for Load Case Number 1

Pile-head boundary conditions are Shear and Moment (BC Type 1)
 Specified shear force at pile head = 1000.000 lbs
 Specified moment at pile head = 1000.000 in-lbs
 Specified axial load at pile head = 1000.000 lbs

Non-zero moment for this load case indicates the pile-head may rotate under the applied pile-head loading, but is not a free-head (zero moment) condition.

Depth Es*h X F/L in lbs/in	Deflect. y in	Moment M lbs-in	Shear V lbs	Slope S Rad.	Total Stress lbs/in**2	Soil Res. p lbs/in
0.000	.039432	1000.0000	1000.0000	-.0008015	18.1395	0.0000
0.0000						
16.900	.025945	17913.4869	794.0008	-.0007368	21.8320	-24.3786
15879.9160						
33.800	.014526	27862.1312	357.3268	-.0005805	24.0040	-27.2988
31759.8320						
50.700	.006325	30010.7526	-99.6337	-.0003828	24.4731	-26.7794
71552.5851						
67.600	.001589	24507.4481	-484.6059	-.0001965	23.2716	-18.7795
199704.						
84.500	-.000317	13637.7140	-584.4328	-6.6185E-05	20.8985	6.9656
371707.						
101.400	-.000648	4755.8553	-394.2820	-3.3476E-06	18.9594	15.5374
405311.						
118.300	-.000430	311.0941	-168.6572	1.3963E-05	17.9891	11.1637
438916.						
135.200	-.000176	-945.2294	-32.7609	1.1796E-05	18.1275	4.9187
472520.						
152.100	-3.11E-05	-796.6227	16.6815	5.8455E-06	18.0951	.9325043
506125.						
169.000	2.17E-05	-381.5914	18.7164	1.8204E-06	18.0045	-.6916961
539729.						
185.900	3.04E-05	-164.0714	10.5616	-4.3773E-08	17.9570	-.2733670
152014.						
202.800	2.02E-05	-24.6088	6.5577	-6.8836E-07	17.9265	-.2004675
167894.						
219.700	7.12E-06	57.6011	1.9640	-5.7565E-07	17.9337	-.3431661
813994.						
236.600	7.22E-07	41.7928	-1.2445	-2.3609E-07	17.9303	-.0365285
855136.						
253.500	-8.55E-07	15.5467	-1.1788	-4.0202E-08	17.9245	.0442995
875533.						
270.400	-6.37E-07	1.9512	-.5256386	1.9576E-08	17.9216	.0329961
875533.						
287.300	-1.93E-07	-2.2206	-.0982932	1.8656E-08	17.9216	.0175773
1535789.						
304.200	-6.35E-09	-1.3718	.0554236	6.3830E-09	17.9214	.0006140
1634263.						
321.100	2.23E-08	-.3474722	.0412542	5.0951E-10	17.9212	-.0022909
1734362.						
338.000	1.09E-08	.0225894	.0119151	-6.0038E-10	17.9212	-.0011812
1836160.						
354.900	2.03E-09	.0552799	-3.4681E-05	-3.3436E-10	17.9212	-.0002330

36 inch pipe - stratum 5 through 7.lpo

1939740.						
371.800	-4.29E-10	.0214285	-.0015641	-7.2301E-11	17.9212	5.1967E-05
2045190.						
388.700	-4.14E-10	.0024168	-.0006792	9.1615E-12	17.9211	5.2748E-05
2152606.						
405.600	-1.20E-10	-.0015298	-9.8061E-05	1.2192E-11	17.9211	1.6030E-05
2262088.						
422.500	-2.04E-12	-.0008981	3.9817E-05	3.8973E-12	17.9211	2.8712E-07
2373749.						
439.400	1.20E-11	-.0001842	2.7353E-05	2.0012E-13	17.9211	-1.7621E-06
2487708.						
456.300	4.72E-12	2.6473E-05	6.3175E-06	-3.3859E-13	17.9211	-7.2730E-07
2604096.						
473.200	5.26E-13	2.9381E-05	-5.4466E-07	-1.4778E-13	17.9211	-8.4794E-08
2723054.						
490.100	-2.75E-13	8.0684E-06	-8.7031E-07	-1.9836E-14	17.9211	4.6257E-08
2844737.						
507.000	-1.44E-13	-3.4261E-08	-2.6536E-07	7.6111E-15	17.9211	2.5335E-08
2969314.						
523.900	-1.75E-14	-9.0095E-07	-5.4682E-09	4.4161E-15	17.9211	5.4210E-09
5221192.						
540.800	5.07E-15	-2.1924E-07	2.6804E-08	5.8923E-16	17.9211	-1.6018E-09
5340698.						
557.700	2.37E-15	5.0097E-09	6.9422E-09	-1.4262E-16	17.9211	-7.4871E-10
5340698.						
574.600	2.48E-16	1.5415E-08	-4.6918E-11	-7.2848E-17	17.9211	-7.8400E-11
5340698.						
591.500	-9.31E-17	3.4263E-09	-4.6089E-10	-8.4812E-18	17.9211	2.9409E-11
5340698.						
608.400	-3.86E-17	-1.6304E-10	-1.0937E-10	2.6670E-18	17.9211	1.2191E-11
5340698.						
625.300	-2.92E-18	-2.7049E-10	3.4257E-12	1.1860E-18	17.9211	1.1576E-12
6705010.						
642.200	1.51E-18	-4.7291E-11	8.1505E-12	1.0033E-19	17.9211	-5.9841E-13
6705010.						
659.100	4.73E-19	4.9974E-12	1.5065E-12	-4.4158E-20	17.9211	-1.8786E-13
6705010.						
676.000	1.57E-20	3.6314E-12	-1.3364E-13	-1.4680E-20	17.9211	-6.2465E-15
6705010.						
692.900	-2.27E-20	4.8094E-13	-1.1037E-13	-6.3086E-22	17.9211	9.0000E-15
6705010.						
709.800	-5.58E-21	-9.9099E-14	-1.5618E-14	6.7362E-22	17.9211	2.2134E-15
6705010.						
726.700	8.39E-23	-4.6966E-14	2.8040E-15	1.7462E-22	17.9211	-3.3270E-17
6705010.						
743.600	3.23E-22	-4.3307E-15	1.4391E-15	-6.2877E-25	17.9211	-1.2826E-16
6705010.						
760.500	6.26E-23	1.6745E-15	1.4544E-16	-9.7034E-24	17.9211	-2.4838E-17
6705010.						
777.400	-4.71E-24	5.8551E-16	-4.8656E-17	-1.9827E-24	17.9211	1.8678E-18
6705010.						
794.300	-4.41E-24	2.9952E-17	-1.8085E-17	1.1989E-25	17.9211	1.7501E-18
6705010.						
811.200	-6.56E-25	-2.5774E-17	-1.0991E-18	1.3416E-25	17.9211	2.6013E-19
6705010.						
828.100	1.24E-25	-7.2017E-18	7.6011E-19	0.0000	17.9211	-4.0107E-20
5486330.						
845.000	0.000	-8.3296E-20	2.2601E-19	0.0000	17.9211	-2.3100E-20
5486330.						
861.900	0.000	4.3752E-19	5.7109E-21	0.0000	17.9211	-2.9708E-21
5486330.						
878.800	0.000	1.0981E-19	-1.2991E-20	0.0000	17.9211	7.5755E-22
5486330.						

36 inch pipe - stratum 5 through 7.1po

895.700	0.000	-1.5585E-21	-3.4660E-21	0.0000	17.9211	3.6966E-22
5486330.						
912.600	0.000	-7.3468E-21	-2.8494E-24	0.0000	17.9211	4.0188E-23
5486330.						
929.500	0.000	-1.6560E-21	2.1947E-22	0.0000	17.9211	-1.3879E-23
5486330.						
946.400	0.000	7.1040E-23	5.2608E-23	0.0000	17.9211	-5.8680E-24
5486330.						
963.300	0.000	1.2215E-22	-1.3725E-24	0.0000	17.9211	-5.2024E-25
5486330.						
980.200	0.000	2.4668E-23	-3.6693E-24	0.0000	17.9211	2.4843E-25
5486330.						
997.100	0.000	-1.8659E-24	-7.8935E-25	0.0000	17.9211	0.0000
5486330.						
1014.	0.000	-2.0125E-24	0.0000	0.0000	17.9211	0.0000
5486330.						
1031.	0.000	-3.6225E-25	0.0000	0.0000	17.9211	0.0000
5486330.						
1048.	0.000	0.0000	0.0000	0.0000	17.9211	0.0000
5486330.						
1065.	0.000	0.0000	0.0000	0.0000	17.9211	0.0000
5486330.						
1082.	0.000	0.0000	0.0000	0.0000	17.9211	0.0000
5486330.						
1099.	0.000	0.0000	0.0000	0.0000	17.9211	0.0000
5486330.						
1115.	0.000	0.0000	0.0000	0.0000	17.9211	0.0000
5486330.						
1132.	0.000	0.0000	0.0000	0.0000	17.9211	0.0000
5486330.						
1149.	0.000	0.0000	0.0000	0.0000	17.9211	0.0000
5486330.						
1166.	0.000	0.0000	0.0000	0.0000	17.9211	0.0000
5486330.						
1183.	0.000	0.0000	0.0000	0.0000	17.9211	0.0000
5486330.						
1200.	0.000	0.0000	0.0000	0.0000	17.9211	0.0000
5486330.						
1217.	0.000	0.0000	0.0000	0.0000	17.9211	0.0000
7404154.						
1234.	0.000	0.0000	0.0000	0.0000	17.9211	0.0000
7404154.						
1251.	0.000	0.0000	0.0000	0.0000	17.9211	0.0000
7404154.						
1268.	0.000	0.0000	0.0000	0.0000	17.9211	0.0000
7404154.						
1284.	0.000	0.0000	0.0000	0.0000	17.9211	0.0000
7404154.						
1301.	0.000	0.0000	0.0000	0.0000	17.9211	0.0000
7404154.						
1318.	0.000	0.0000	0.0000	0.0000	17.9211	0.0000
7404154.						
1335.	0.000	0.0000	0.0000	0.0000	17.9211	0.0000
7404154.						
1352.	0.000	0.0000	0.0000	0.0000	17.9211	0.0000
7404154.						
1369.	0.000	0.0000	0.0000	0.0000	17.9211	0.0000
1.0911E+07						
1386.	0.000	0.0000	0.0000	0.0000	17.9211	0.0000
1.0911E+07						
1403.	0.000	0.0000	0.0000	0.0000	17.9211	0.0000
1.0911E+07						
1420.	0.000	0.0000	0.0000	0.0000	17.9211	0.0000

36 inch pipe - stratum 5 through 7.lpo

1.0911E+07						
1436.	0.000	0.0000	0.0000	0.0000	17.9211	0.0000
1.0911E+07						
1453.	0.000	0.0000	0.0000	0.0000	17.9211	0.0000
1.0911E+07						
1470.	0.000	0.0000	0.0000	0.0000	17.9211	0.0000
1.0911E+07						
1487.	0.000	0.0000	0.0000	0.0000	17.9211	0.0000
1.0911E+07						
1504.	0.000	0.0000	0.0000	0.0000	17.9211	0.0000
1.0911E+07						
1521.	0.000	0.0000	0.0000	0.0000	17.9211	0.0000
1.0911E+07						
1538.	0.000	0.0000	0.0000	0.0000	17.9211	0.0000
1.0911E+07						
1555.	0.000	0.0000	0.0000	0.0000	17.9211	0.0000
1.0911E+07						
1572.	0.000	0.0000	0.0000	0.0000	17.9211	0.0000
1.0911E+07						
1589.	0.000	0.0000	0.0000	0.0000	17.9211	0.0000
1.0911E+07						
1605.	0.000	0.0000	0.0000	0.0000	17.9211	0.0000
1.0911E+07						
1622.	0.000	0.0000	0.0000	0.0000	17.9211	0.0000
1.0911E+07						
1639.	0.000	0.0000	0.0000	0.0000	17.9211	0.0000
1.0911E+07						
1656.	0.000	0.0000	0.0000	0.0000	17.9211	0.0000
1.0911E+07						
1673.	0.000	0.0000	0.0000	0.0000	17.9211	0.0000
1.0911E+07						
1690.	0.000	0.0000	0.0000	0.0000	17.9211	0.0000
5455523.						

Output Verification:

Computed forces and moments are within specified convergence limits.

Output Summary for Load Case No. 1:

Pile-head deflection = .03943154 in
 Computed slope at pile head = -.00080146
 Maximum bending moment = 30010.75261 lbs-in
 Maximum shear force = 1000.00000 lbs
 Depth of maximum bending moment = 50.70000000 in
 Depth of maximum shear force = 0.00000 in
 Number of iterations = 9
 Number of zero deflection points = 32

 Summary of Pile Response(s)

Definition of Symbols for Pile-Head Loading Conditions:

Type 1 = Shear and Moment, y = pile-head displacement in
 Type 2 = Shear and Slope, M = Pile-head Moment lbs-in
 Type 3 = Shear and Rot. Stiffness, V = Pile-head Shear Force lbs
 Page 14

36 inch pipe - stratum 5 through 7.1po

Type 4 = Deflection and Moment, S = Pile-head Slope, radians
Type 5 = Deflection and Slope, R = Rot. Stiffness of Pile-head in-lbs/rad

Load Type	Pile-Head Condition 1	Pile-Head Condition 2	Axial Load lbs	Pile-Head Deflection in	Maximum Moment in-lbs	Maximum Shear lbs
1	V= 1000.000	M= 1000.000	1000.0000	.0394315	30010.7526	1000.0000

The analysis ended normally.

36 inch pipe - stratum 8 through 10.lpo

LPILE Plus for Windows, Version 5.0 (5.0.30)

Analysis of Individual Piles and Drilled Shafts
Subjected to Lateral Loading Using the p-y Method

(c) 1985-2007 by Ensoft, Inc.
All Rights Reserved

This program is licensed to:

DJI
Eustis

Path to file locations: U:\sys\WPDATA\Projects\20749\Piles\LPile\
Name of input data file: 36 inch pipe - stratum 8 through 10.lpd
Name of output file: 36 inch pipe - stratum 8 through 10.lpo
Name of plot output file: 36 inch pipe - stratum 8 through 10.lpp
Name of runtime file: 36 inch pipe - stratum 8 through 10.lpr

Time and Date of Analysis

Date: November 9, 2009 Time: 17:44:32

Problem Title

EE20749 - St. Mary Floodgate Structure at Franklin Drainage Canal

Program Options

Units Used in Computations - US Customary Units: Inches, Pounds

Basic Program Options:

Analysis Type 1:

- Computation of Lateral Pile Response Using User-specified Constant EI

Computation Options:

- Only internally-generated p-y curves used in analysis
- Analysis does not use p-y multipliers (individual pile or shaft action only)
- Analysis assumes no shear resistance at pile tip
- Analysis for fixed-length pile or shaft only
- No computation of foundation stiffness matrix elements
- Output pile response for full length of pile
- Analysis assumes no soil movements acting on pile
- Additional p-y curves computed at specified depths

Solution Control Parameters:

- Number of pile increments = 100
- Maximum number of iterations allowed = 100

36 inch pipe - stratum 8 through 10.lpo

- Deflection tolerance for convergence = 1.0000E-05 in
- Maximum allowable deflection = 1.0000E+02 in

Printing Options:

- Values of pile-head deflection, bending moment, shear force, and soil reaction are printed for full length of pile.
- Printing Increment (spacing of output points) = 1

Pile Structural Properties and Geometry

Pile Length = 1690.00 in
Depth of ground surface below top of pile = .00 in
Slope angle of ground surface = .00 deg.

Structural properties of pile defined using 2 points

Point	Depth X in	Pile Diameter in	Moment of Inertia in**4	Pile Area Sq.in	Modulus of Elasticity lbs/Sq.in
1	0.0000	36.00000000	82448.0000	55.8000	30000.00000
2	1690.0000	36.00000000	82448.0000	55.8000	30000.00000

Soil and Rock Layering Information

The soil profile is modelled using 10 layers

Layer 1 is silt with cohesion and friction
Distance from top of pile to top of layer = .000 in
Distance from top of pile to bottom of layer = 36.000 in
p-y subgrade modulus k for top of soil layer = 55.600 lbs/in**3
p-y subgrade modulus k for bottom of layer = 55.600 lbs/in**3

Layer 2 is soft clay, p-y criteria by Matlock, 1970
Distance from top of pile to top of layer = 36.000 in
Distance from top of pile to bottom of layer = 180.000 in

Layer 3 is silt with cohesion and friction
Distance from top of pile to top of layer = 180.000 in
Distance from top of pile to bottom of layer = 204.000 in
p-y subgrade modulus k for top of soil layer = 55.600 lbs/in**3
p-y subgrade modulus k for bottom of layer = 55.600 lbs/in**3

Layer 4 is soft clay, p-y criteria by Matlock, 1970
Distance from top of pile to top of layer = 204.000 in
Distance from top of pile to bottom of layer = 276.000 in

Layer 5 is soft clay, p-y criteria by Matlock, 1970
Distance from top of pile to top of layer = 276.000 in
Distance from top of pile to bottom of layer = 516.000 in

Layer 6 is stiff clay without free water
Distance from top of pile to top of layer = 516.000 in
Distance from top of pile to bottom of layer = 612.000 in

Layer 7 is stiff clay without free water
Distance from top of pile to top of layer = 612.000 in

36 inch pipe - stratum 8 through 10.1po
 Distance from top of pile to bottom of layer = 828.000 in

Layer 8 is stiff clay without free water
 Distance from top of pile to top of layer = 828.000 in
 Distance from top of pile to bottom of layer = 1212.000 in

Layer 9 is stiff clay without free water
 Distance from top of pile to top of layer = 1212.000 in
 Distance from top of pile to bottom of layer = 1356.000 in

Layer 10 is stiff clay without free water
 Distance from top of pile to top of layer = 1356.000 in
 Distance from top of pile to bottom of layer = 1692.000 in

(Depth of lowest layer extends 2.00 in below pile tip)

 Effective Unit Weight of Soil vs. Depth

Distribution of effective unit weight of soil with depth
 is defined using 20 points

Point No.	Depth X in	Eff. Unit Weight lbs/in**3
1	.00	.03160
2	36.00	.03160
3	36.00	.03330
4	180.00	.03330
5	180.00	.03160
6	204.00	.03160
7	204.00	.03480
8	276.00	.03480
9	276.00	.03250
10	516.00	.03250
11	516.00	.03620
12	612.00	.03620
13	612.00	.03550
14	828.00	.03550
15	828.00	.03110
16	1212.00	.03110
17	1212.00	.03040
18	1356.00	.03040
19	1356.00	.03450
20	1692.00	.03450

 Shear Strength of Soils

Distribution of shear strength parameters with depth
 defined using 20 points

Point No.	Depth X in	Cohesion c lbs/in**2	Angle of Friction Deg.	E50 or k _{rm}	RQD %
1	.000	1.38890	15.00	.02000	.0
2	36.000	1.38890	15.00	.02000	.0

36 inch pipe - stratum 8 through 10.1po					
3	36.000	2.20140	.00	.02000	.0
4	180.000	2.20140	.00	.02000	.0
5	180.000	1.38890	15.00	.02000	.0
6	204.000	1.38890	15.00	.02000	.0
7	204.000	3.12500	.00	.02000	.0
8	276.000	3.12500	.00	.02000	.0
9	276.000	4.16670	.00	.01000	.0
10	516.000	7.63890	.00	.00700	.0
11	516.000	7.63890	.00	.00700	.0
12	612.000	7.63890	.00	.00700	.0
13	612.000	9.59030	.00	.00700	.0
14	828.000	9.59030	.00	.00700	.0
15	828.000	7.84720	.00	.00700	.0
16	1212.000	7.84720	.00	.00700	.0
17	1212.000	10.59030	.00	.00700	.0
18	1356.000	10.59030	.00	.00700	.0
19	1356.000	14.34720	.00	.00500	.0
20	1692.000	14.34720	.00	.00500	.0

Notes:

- (1) Cohesion = uniaxial compressive strength for rock materials.
- (2) Values of E50 are reported for clay strata.
- (3) Default values will be generated for E50 when input values are 0.
- (4) RQD and k_{rm} are reported only for weak rock strata.

Loading Type

Cyclic loading criteria was used for computation of p-y curves

Number of cycles of loading = 1000.

Pile-head Loading and Pile-head Fixity Conditions

Number of loads specified = 1

Load Case Number 1

Pile-head boundary conditions are Shear and Moment (BC Type 1)

Shear force at pile head = 1000.000 lbs
Bending moment at pile head = 1000.000 in-lbs
Axial load at pile head = 1000.000 lbs

Non-zero moment at pile head for this load case indicates the pile-head may rotate under the applied pile-head loading, but is not a free-head (zero moment) condition.

Output of p-y Curves at Specified Depths

36 inch pipe - stratum 8 through 10.1po

p-y curves are generated and printed for verification at 8 depths.

Depth No.	Depth Below Pile Head in	Depth Below Ground Surface in
1	840.000	840.000
2	1020.000	1020.000
3	1200.000	1200.000
4	1224.000	1224.000
5	1284.000	1284.000
6	1344.000	1344.000
7	1524.000	1524.000
8	1690.000	1690.000

Depth of ground surface below top of pile = .00 in

p-y Curve Computed Using Cyclic Criteria for Stiff Clay without Free Water

Soil Layer Number = 8
 Depth below pile head = 840.000 in
 Depth below ground surface = 840.000 in
 Equivalent Depth = 650.830 in
 Diameter = 36.000 in
 Undrained cohesion, c = 7.84720 lbs/in**2
 Average Eff. Unit Weight = .03394 lbs/in**3
 Epsilon-50 = .00700
 Pct = 4196.404 lbs/in
 Pcd = 2542.493 lbs/in
 Pu = 2542.493 lbs/in
 y50 = .630 in
 p-multiplier = 1.00000
 y-multiplier = 1.00000
 Number of cycles of loading = 1000.

y, in	p, lbs/in
0.0000	0.0000
.0001008	110.5275
.0005040	165.2771
.0010080	196.5487
.0050400	293.9089
.0100800	349.5185
.0504000	522.6521
.1008000	621.5416
.2520000	781.5472
.5040000	929.4215
.7560000	1028.5740
1.0080	1105.2747
2.5200	1389.8093
5.0400	1652.7711
10.0800	1965.4872
22.6800	2407.2204
35.2800	2542.4928

p-y Curve Computed Using Cyclic Criteria for Stiff Clay without Free Water

Soil Layer Number = 8
 Depth below pile head = 1020.000 in
 Depth below ground surface = 1020.000 in
 Page 5

36 inch pipe - stratum 8 through 10.1po

Equivalent Depth = 830.830 in
 Diameter = 36.000 in
 Undrained cohesion, c = 7.84720 lbs/in**2
 Average Eff. Unit weight = .03344 lbs/in**3
 Epsilon-50 = .00700
 Pct = 5107.598 lbs/in
 Pcd = 2542.493 lbs/in
 Pu = 2542.493 lbs/in
 y50 = .630 in
 p-multiplier = 1.00000
 y-multiplier = 1.00000
 Number of cycles of loading = 1000.

y, in	p, lbs/in
0.0000	0.0000
.0001008	110.5275
.0005040	165.2771
.0010080	196.5487
.0050400	293.9089
.0100800	349.5185
.0504000	522.6521
.1008000	621.5416
.2520000	781.5472
.5040000	929.4215
.7560000	1028.5740
1.0080	1105.2747
2.5200	1389.8093
5.0400	1652.7711
10.0800	1965.4872
22.6800	2407.2204
35.2800	2542.4928

p-y Curve Computed Using Cyclic Criteria for Stiff Clay without Free Water

Soil Layer Number = 8
 Depth below pile head = 1200.000 in
 Depth below ground surface = 1200.000 in
 Equivalent Depth = 1010.830 in
 Diameter = 36.000 in
 Undrained cohesion, c = 7.84720 lbs/in**2
 Average Eff. Unit weight = .03309 lbs/in**3
 Epsilon-50 = .00700
 Pct = 6017.767 lbs/in
 Pcd = 2542.493 lbs/in
 Pu = 2542.493 lbs/in
 y50 = .630 in
 p-multiplier = 1.00000
 y-multiplier = 1.00000
 Number of cycles of loading = 1000.

y, in	p, lbs/in
0.0000	0.0000
.0001008	110.5275
.0005040	165.2771
.0010080	196.5487
.0050400	293.9089
.0100800	349.5185
.0504000	522.6521
.1008000	621.5416
.2520000	781.5472

36 inch pipe - stratum 8 through 10.1po

.5040000	929.4215
.7560000	1028.5740
1.0080	1105.2747
2.5200	1389.8093
5.0400	1652.7711
10.0800	1965.4872
22.6800	2407.2204
35.2800	2542.4928

p-y Curve Computed Using cyclic Criteria for Stiff Clay without Free Water

Soil Layer Number	=	9
Depth below pile head	=	1224.000 in
Depth below ground surface	=	1224.000 in
Equivalent Depth	=	806.057 in
Diameter	=	36.000 in
Undrained cohesion, c	=	10.59030 lbs/in**2
Average Eff. Unit Weight	=	.03305 lbs/in**3
Epsilon-50	=	.00700
Pct	=	6370.852 lbs/in
Pcd	=	3431.257 lbs/in
Pu	=	3431.257 lbs/in
y50	=	.630 in
p-multiplier	=	1.00000
y-multiplier	=	1.00000
Number of cycles of loading	=	1000.

y, in	p, lbs/in
0.0000	0.0000
.0001008	149.1639
.0005040	223.0521
.0010080	265.2551
.0050400	396.6489
.0100800	471.6977
.0504000	705.3526
.1008000	838.8103
.2520000	1054.7481
.5040000	1254.3140
.7560000	1388.1266
1.0080	1491.6391
2.5200	1875.6369
5.0400	2230.5207
10.0800	2652.5511
22.6800	3248.6984
35.2800	3431.2572

p-y Curve Computed Using cyclic Criteria for Stiff Clay without Free Water

Soil Layer Number	=	9
Depth below pile head	=	1284.000 in
Depth below ground surface	=	1284.000 in
Equivalent Depth	=	866.057 in
Diameter	=	36.000 in
Undrained cohesion, c	=	10.59030 lbs/in**2
Average Eff. Unit Weight	=	.03292 lbs/in**3
Epsilon-50	=	.00700
Pct	=	6756.085 lbs/in

36 inch pipe - stratum 8 through 10.lpo

Pcd = 3431.257 lbs/in
 Pu = 3431.257 lbs/in
 y50 = .630 in
 p-multiplier = 1.00000
 y-multiplier = 1.00000
 Number of cycles of loading = 1000.

y, in	p, lbs/in
0.0000	0.0000
.0001008	149.1639
.0005040	223.0521
.0010080	265.2551
.0050400	396.6489
.0100800	471.6977
.0504000	705.3526
.1008000	838.8103
.2520000	1054.7481
.5040000	1254.3140
.7560000	1388.1266
1.0080	1491.6391
2.5200	1875.6369
5.0400	2230.5207
10.0800	2652.5511
22.6800	3248.6984
35.2800	3431.2572

p-y Curve Computed Using Cyclic Criteria for Stiff Clay without Free Water

Soil Layer Number = 9
 Depth below pile head = 1344.000 in
 Depth below ground surface = 1344.000 in
 Equivalent Depth = 926.057 in
 Diameter = 36.000 in
 Undrained cohesion, c = 10.59030 lbs/in**2
 Average Eff. Unit weight = .03281 lbs/in**3
 Epsilon-50 = .00700
 Pct = 7141.152 lbs/in
 Pcd = 3431.257 lbs/in
 Pu = 3431.257 lbs/in
 y50 = .630 in
 p-multiplier = 1.00000
 y-multiplier = 1.00000
 Number of cycles of loading = 1000.

y, in	p, lbs/in
0.0000	0.0000
.0001008	149.1639
.0005040	223.0521
.0010080	265.2551
.0050400	396.6489
.0100800	471.6977
.0504000	705.3526
.1008000	838.8103
.2520000	1054.7481
.5040000	1254.3140
.7560000	1388.1266
1.0080	1491.6391
2.5200	1875.6369
5.0400	2230.5207
10.0800	2652.5511

22.6800 36 inch pipe - stratum 8 through 10.7po
 35.2800 3248.6984
 3431.2572

p-y Curve Computed Using Cyclic Criteria for Stiff Clay without Free Water

Soil Layer Number = 10
 Depth below pile head = 1524.000 in
 Depth below ground surface = 1524.000 in
 Equivalent Depth = 893.738 in
 Diameter = 36.000 in
 Undrained cohesion, c = 14.34720 lbs/in**2
 Average Eff. Unit weight = .03298 lbs/in**3
 Epsilon-50 = .00500
 Pct = 9021.815 lbs/in
 Pcd = 4648.493 lbs/in
 Pu = 4648.493 lbs/in
 y50 = .450 in
 p-multiplier = 1.00000
 y-multiplier = 1.00000
 Number of cycles of loading = 1000.

y, in	p, lbs/in
0.0000	0.0000
7.2000E-05	202.0797
.0003600	302.1796
.0007200	359.3541
.0036000	537.3598
.0072000	639.0321
.0360000	955.5758
.0720000	1136.3776
.1800000	1428.9191
.3600000	1699.2808
.5400000	1880.5634
.7200000	2020.7968
1.80000	2541.0175
3.60000	3021.7961
7.20000	3593.5414
16.2000	4401.1714
25.2000	4648.4928

p-y Curve Computed Using Cyclic Criteria for Stiff Clay without Free Water

Soil Layer Number = 10
 Depth below pile head = 1690.000 in
 Depth below ground surface = 1690.000 in
 Equivalent Depth = 1059.738 in
 Diameter = 36.000 in
 Undrained cohesion, c = 14.34720 lbs/in**2
 Average Eff. Unit weight = .03313 lbs/in**3
 Epsilon-50 = .00500
 Pct = 10415.409 lbs/in
 Pcd = 4648.493 lbs/in
 Pu = 4648.493 lbs/in
 y50 = .450 in
 p-multiplier = 1.00000
 y-multiplier = 1.00000
 Number of cycles of loading = 1000.

36 inch pipe - stratum 8 through 10.lpo

y, in	p, lbs/in
0.0000	0.0000
7.2000E-05	202.0797
.0003600	302.1796
.0007200	359.3541
.0036000	537.3598
.0072000	639.0321
.0360000	955.5758
.0720000	1136.3776
.1800000	1428.9191
.3600000	1699.2808
.5400000	1880.5634
.7200000	2020.7968
1.8000	2541.0175
3.6000	3021.7961
7.2000	3593.5414
16.2000	4401.1714
25.2000	4648.4928

 Computed Values of Load Distribution and Deflection
 for Lateral Loading for Load Case Number 1

Pile-head boundary conditions are Shear and Moment (BC Type 1)
 Specified shear force at pile head = 1000.000 lbs
 Specified moment at pile head = 1000.000 in-lbs
 Specified axial load at pile head = 1000.000 lbs

Non-zero moment for this load case indicates the pile-head may rotate under the applied pile-head loading, but is not a free-head (zero moment) condition.

Depth Es*h X F/L in lbs/in	Deflect. y in	Moment M lbs-in	Shear V lbs	Slope S Rad.	Total Stress lbs/in**2	Soil Res. p lbs/in
0.000	.039432	1000.0000	1000.0000	-.0008015	18.1395	0.0000
0.0000						
16.900	.025945	17913.4869	794.0008	-.0007368	21.8320	-24.3786
15879.9160						
33.800	.014526	27862.1312	357.3268	-.0005805	24.0040	-27.2988
31759.8320						
50.700	.006325	30010.7526	-99.6337	-.0003828	24.4731	-26.7794
71552.5851						
67.600	.001589	24507.4481	-484.6059	-.0001965	23.2716	-18.7795
199704.						
84.500	-.000317	13637.7140	-584.4328	-6.6185E-05	20.8985	6.9656
371707.						
101.400	-.000648	4755.8553	-394.2820	-3.3476E-06	18.9594	15.5374
405311.						
118.300	-.000430	311.0941	-168.6572	1.3963E-05	17.9891	11.1637
438916.						
135.200	-.000176	-945.2294	-32.7609	1.1796E-05	18.1275	4.9187

36 inch pipe - stratum 8 through 10.lpo

472520.						
152.100	-3.11E-05	-796.6227	16.6815	5.8455E-06	18.0951	.9325043
506125.						
169.000	2.17E-05	-381.5914	18.7164	1.8204E-06	18.0045	-.6916961
539729.						
185.900	3.04E-05	-164.0714	10.5616	-4.3773E-08	17.9570	-.2733670
152014.						
202.800	2.02E-05	-24.6088	6.5577	-6.8836E-07	17.9265	-.2004675
167894.						
219.700	7.12E-06	57.6011	1.9640	-5.7565E-07	17.9337	-.3431661
813994.						
236.600	7.22E-07	41.7928	-1.2445	-2.3609E-07	17.9303	-.0365285
855136.						
253.500	-8.55E-07	15.5467	-1.1788	-4.0202E-08	17.9245	.0442995
875533.						
270.400	-6.37E-07	1.9512	-.5256386	1.9576E-08	17.9216	.0329961
875533.						
287.300	-1.93E-07	-2.2206	-.0982932	1.8656E-08	17.9216	.0175773
1535789.						
304.200	-6.35E-09	-1.3718	.0554236	6.3830E-09	17.9214	.0006140
1634263.						
321.100	2.23E-08	-.3474722	.0412542	5.0951E-10	17.9212	-.0022909
1734362.						
338.000	1.09E-08	.0225894	.0119151	-6.0038E-10	17.9212	-.0011812
1836160.						
354.900	2.03E-09	.0552799	-3.4681E-05	-3.3436E-10	17.9212	-.0002330
1939740.						
371.800	-4.29E-10	.0214285	-.0015641	-7.2301E-11	17.9212	5.1967E-05
2045190.						
388.700	-4.14E-10	.0024168	-.0006792	9.1615E-12	17.9211	5.2748E-05
2152606.						
405.600	-1.20E-10	-.0015298	-9.8061E-05	1.2192E-11	17.9211	1.6030E-05
2262088.						
422.500	-2.04E-12	-.0008981	3.9817E-05	3.8973E-12	17.9211	2.8712E-07
2373749.						
439.400	1.20E-11	-.0001842	2.7353E-05	2.0012E-13	17.9211	-1.7621E-06
2487708.						
456.300	4.72E-12	2.6473E-05	6.3175E-06	-3.3859E-13	17.9211	-7.2730E-07
2604096.						
473.200	5.26E-13	2.9381E-05	-5.4466E-07	-1.4778E-13	17.9211	-8.4794E-08
2723054.						
490.100	-2.75E-13	8.0684E-06	-8.7031E-07	-1.9836E-14	17.9211	4.6257E-08
2844737.						
507.000	-1.44E-13	-3.4261E-08	-2.6536E-07	7.6111E-15	17.9211	2.5335E-08
2969314.						
523.900	-1.75E-14	-9.0095E-07	-5.4682E-09	4.4161E-15	17.9211	5.4210E-09
5221192.						
540.800	5.07E-15	-2.1924E-07	2.6804E-08	5.8923E-16	17.9211	-1.6018E-09
5340698.						
557.700	2.37E-15	5.0097E-09	6.9422E-09	-1.4262E-16	17.9211	-7.4871E-10
5340698.						
574.600	2.48E-16	1.5415E-08	-4.6918E-11	-7.2848E-17	17.9211	-7.8400E-11
5340698.						
591.500	-9.31E-17	3.4263E-09	-4.6089E-10	-8.4812E-18	17.9211	2.9409E-11
5340698.						
608.400	-3.86E-17	-1.6304E-10	-1.0937E-10	2.6670E-18	17.9211	1.2191E-11
5340698.						
625.300	-2.92E-18	-2.7049E-10	3.4257E-12	1.1860E-18	17.9211	1.1576E-12
6705010.						
642.200	1.51E-18	-4.7291E-11	8.1505E-12	1.0033E-19	17.9211	-5.9841E-13
6705010.						
659.100	4.73E-19	4.9974E-12	1.5065E-12	-4.4158E-20	17.9211	-1.8786E-13
6705010.						

36 inch pipe - stratum 8 through 10.lpo

676.000	1.57E-20	3.6314E-12	-1.3364E-13	-1.4680E-20	17.9211	-6.2465E-15
6705010.						
692.900	-2.27E-20	4.8094E-13	-1.1037E-13	-6.3086E-22	17.9211	9.0000E-15
6705010.						
709.800	-5.58E-21	-9.9099E-14	-1.5618E-14	6.7362E-22	17.9211	2.2134E-15
6705010.						
726.700	8.39E-23	-4.6966E-14	2.8040E-15	1.7462E-22	17.9211	-3.3270E-17
6705010.						
743.600	3.23E-22	-4.3307E-15	1.4391E-15	-6.2877E-25	17.9211	-1.2826E-16
6705010.						
760.500	6.26E-23	1.6745E-15	1.4544E-16	-9.7034E-24	17.9211	-2.4838E-17
6705010.						
777.400	-4.71E-24	5.8551E-16	-4.8656E-17	-1.9827E-24	17.9211	1.8678E-18
6705010.						
794.300	-4.41E-24	2.9952E-17	-1.8085E-17	1.1989E-25	17.9211	1.7501E-18
6705010.						
811.200	-6.56E-25	-2.5774E-17	-1.0991E-18	1.3416E-25	17.9211	2.6013E-19
6705010.						
828.100	1.24E-25	-7.2017E-18	7.6011E-19	0.0000	17.9211	-4.0107E-20
5486330.						
845.000	0.000	-8.3296E-20	2.2601E-19	0.0000	17.9211	-2.3100E-20
5486330.						
861.900	0.000	4.3752E-19	5.7109E-21	0.0000	17.9211	-2.9708E-21
5486330.						
878.800	0.000	1.0981E-19	-1.2991E-20	0.0000	17.9211	7.5755E-22
5486330.						
895.700	0.000	-1.5585E-21	-3.4660E-21	0.0000	17.9211	3.6966E-22
5486330.						
912.600	0.000	-7.3468E-21	-2.8494E-24	0.0000	17.9211	4.0188E-23
5486330.						
929.500	0.000	-1.6560E-21	2.1947E-22	0.0000	17.9211	-1.3879E-23
5486330.						
946.400	0.000	7.1040E-23	5.2608E-23	0.0000	17.9211	-5.8680E-24
5486330.						
963.300	0.000	1.2215E-22	-1.3725E-24	0.0000	17.9211	-5.2024E-25
5486330.						
980.200	0.000	2.4668E-23	-3.6693E-24	0.0000	17.9211	2.4843E-25
5486330.						
997.100	0.000	-1.8659E-24	-7.8935E-25	0.0000	17.9211	0.0000
5486330.						
1014.	0.000	-2.0125E-24	0.0000	0.0000	17.9211	0.0000
5486330.						
1031.	0.000	-3.6225E-25	0.0000	0.0000	17.9211	0.0000
5486330.						
1048.	0.000	0.0000	0.0000	0.0000	17.9211	0.0000
5486330.						
1065.	0.000	0.0000	0.0000	0.0000	17.9211	0.0000
5486330.						
1082.	0.000	0.0000	0.0000	0.0000	17.9211	0.0000
5486330.						
1099.	0.000	0.0000	0.0000	0.0000	17.9211	0.0000
5486330.						
1115.	0.000	0.0000	0.0000	0.0000	17.9211	0.0000
5486330.						
1132.	0.000	0.0000	0.0000	0.0000	17.9211	0.0000
5486330.						
1149.	0.000	0.0000	0.0000	0.0000	17.9211	0.0000
5486330.						
1166.	0.000	0.0000	0.0000	0.0000	17.9211	0.0000
5486330.						
1183.	0.000	0.0000	0.0000	0.0000	17.9211	0.0000
5486330.						
1200.	0.000	0.0000	0.0000	0.0000	17.9211	0.0000

36 inch pipe - stratum 8 through 10.1po

5486330.						
1217.	0.000	0.0000	0.0000	0.0000	17.9211	0.0000
7404154.						
1234.	0.000	0.0000	0.0000	0.0000	17.9211	0.0000
7404154.						
1251.	0.000	0.0000	0.0000	0.0000	17.9211	0.0000
7404154.						
1268.	0.000	0.0000	0.0000	0.0000	17.9211	0.0000
7404154.						
1284.	0.000	0.0000	0.0000	0.0000	17.9211	0.0000
7404154.						
1301.	0.000	0.0000	0.0000	0.0000	17.9211	0.0000
7404154.						
1318.	0.000	0.0000	0.0000	0.0000	17.9211	0.0000
7404154.						
1335.	0.000	0.0000	0.0000	0.0000	17.9211	0.0000
7404154.						
1352.	0.000	0.0000	0.0000	0.0000	17.9211	0.0000
7404154.						
1369.	0.000	0.0000	0.0000	0.0000	17.9211	0.0000
1.0911E+07						
1386.	0.000	0.0000	0.0000	0.0000	17.9211	0.0000
1.0911E+07						
1403.	0.000	0.0000	0.0000	0.0000	17.9211	0.0000
1.0911E+07						
1420.	0.000	0.0000	0.0000	0.0000	17.9211	0.0000
1.0911E+07						
1436.	0.000	0.0000	0.0000	0.0000	17.9211	0.0000
1.0911E+07						
1453.	0.000	0.0000	0.0000	0.0000	17.9211	0.0000
1.0911E+07						
1470.	0.000	0.0000	0.0000	0.0000	17.9211	0.0000
1.0911E+07						
1487.	0.000	0.0000	0.0000	0.0000	17.9211	0.0000
1.0911E+07						
1504.	0.000	0.0000	0.0000	0.0000	17.9211	0.0000
1.0911E+07						
1521.	0.000	0.0000	0.0000	0.0000	17.9211	0.0000
1.0911E+07						
1538.	0.000	0.0000	0.0000	0.0000	17.9211	0.0000
1.0911E+07						
1555.	0.000	0.0000	0.0000	0.0000	17.9211	0.0000
1.0911E+07						
1572.	0.000	0.0000	0.0000	0.0000	17.9211	0.0000
1.0911E+07						
1589.	0.000	0.0000	0.0000	0.0000	17.9211	0.0000
1.0911E+07						
1605.	0.000	0.0000	0.0000	0.0000	17.9211	0.0000
1.0911E+07						
1622.	0.000	0.0000	0.0000	0.0000	17.9211	0.0000
1.0911E+07						
1639.	0.000	0.0000	0.0000	0.0000	17.9211	0.0000
1.0911E+07						
1656.	0.000	0.0000	0.0000	0.0000	17.9211	0.0000
1.0911E+07						
1673.	0.000	0.0000	0.0000	0.0000	17.9211	0.0000
1.0911E+07						
1690.	0.000	0.0000	0.0000	0.0000	17.9211	0.0000
5455523.						

Output Verification:

Computed forces and moments are within specified convergence limits.

36 inch pipe - stratum 8 through 10.1po

Output Summary for Load Case No. 1:

Pile-head deflection = .03943154 in
 Computed slope at pile head = -.00080146
 Maximum bending moment = 30010.75261 lbs-in
 Maximum shear force = 1000.00000 lbs
 Depth of maximum bending moment = 50.70000000 in
 Depth of maximum shear force = 0.00000 in
 Number of iterations = 9
 Number of zero deflection points = 32

 Summary of Pile Response(s)

Definition of Symbols for Pile-Head Loading Conditions:

Type 1 = Shear and Moment, y = pile-head displacement in
 Type 2 = Shear and Slope, M = Pile-head Moment lbs-in
 Type 3 = Shear and Rot. Stiffness, V = Pile-head Shear Force lbs
 Type 4 = Deflection and Moment, S = Pile-head Slope, radians
 Type 5 = Deflection and Slope, R = Rot. Stiffness of Pile-head in-lbs/rad

Load Type	Pile-Head Condition 1	Pile-Head Condition 2	Axial Load lbs	Pile-Head Deflection in	Maximum Moment in-lbs	Maximum Shear lbs
1	V= 1000.000	M= 1000.000	1000.0000	.0394315	30010.7526	1000.0000

The analysis ended normally.

42 inch pipe - stratum 1 through 4.lpo

LPILE Plus for Windows, Version 5.0 (5.0.30)

Analysis of Individual Piles and Drilled Shafts
Subjected to Lateral Loading Using the p-y Method

(c) 1985-2007 by Ensoft, Inc.
All Rights Reserved

This program is licensed to:

DJI
Eustis

Path to file locations: U:\sys\WPDATA\Projects\20749\Piles\LPile\
Name of input data file: 42 inch pipe - stratum 1 through 4.lpd
Name of output file: 42 inch pipe - stratum 1 through 4.lpo
Name of plot output file: 42 inch pipe - stratum 1 through 4.lpp
Name of runtime file: 42 inch pipe - stratum 1 through 4.lpr

Time and Date of Analysis

Date: November 9, 2009 Time: 17:29: 7

Problem Title

EE20749 - St. Mary Floodgate Structure at Franklin Drainage Canal

Program Options

Units Used in Computations - US Customary Units: Inches, Pounds

Basic Program Options:

Analysis Type 1:

- Computation of Lateral Pile Response Using User-specified Constant EI

Computation Options:

- Only internally-generated p-y curves used in analysis
- Analysis does not use p-y multipliers (individual pile or shaft action only)
- Analysis assumes no shear resistance at pile tip
- Analysis for fixed-length pile or shaft only
- No computation of foundation stiffness matrix elements
- Output pile response for full length of pile
- Analysis assumes no soil movements acting on pile
- Additional p-y curves computed at specified depths

Solution Control Parameters:

- Number of pile increments = 100
- Maximum number of iterations allowed = 100

- 42 inch pipe - stratum 1 through 4.lpo
- Deflection tolerance for convergence = 1.0000E-05 in
 - Maximum allowable deflection = 1.0000E+02 in

Printing Options:

- Values of pile-head deflection, bending moment, shear force, and soil reaction are printed for full length of pile.
- Printing Increment (spacing of output points) = 1

Pile Structural Properties and Geometry

Pile Length = 1690.00 in
Depth of ground surface below top of pile = .00 in
Slope angle of ground surface = .00 deg.

Structural properties of pile defined using 2 points

Point	Depth X in	Pile Diameter in	Moment of Inertia in**4	Pile Area Sq.in	Modulus of Elasticity lbs/Sq.in
1	0.0000	42.00000000	152745.0000	65.2000	30000.00000
2	1690.0000	42.00000000	152745.0000	65.2000	30000.00000

Soil and Rock Layering Information

The soil profile is modelled using 10 layers

Layer 1 is silt with cohesion and friction
Distance from top of pile to top of layer = .000 in
Distance from top of pile to bottom of layer = 36.000 in
p-y subgrade modulus k for top of soil layer = 55.600 lbs/in**3
p-y subgrade modulus k for bottom of layer = 55.600 lbs/in**3

Layer 2 is soft clay, p-y criteria by Matlock, 1970
Distance from top of pile to top of layer = 36.000 in
Distance from top of pile to bottom of layer = 180.000 in

Layer 3 is silt with cohesion and friction
Distance from top of pile to top of layer = 180.000 in
Distance from top of pile to bottom of layer = 204.000 in
p-y subgrade modulus k for top of soil layer = 55.600 lbs/in**3
p-y subgrade modulus k for bottom of layer = 55.600 lbs/in**3

Layer 4 is soft clay, p-y criteria by Matlock, 1970
Distance from top of pile to top of layer = 204.000 in
Distance from top of pile to bottom of layer = 276.000 in

Layer 5 is soft clay, p-y criteria by Matlock, 1970
Distance from top of pile to top of layer = 276.000 in
Distance from top of pile to bottom of layer = 516.000 in

Layer 6 is stiff clay without free water
Distance from top of pile to top of layer = 516.000 in
Distance from top of pile to bottom of layer = 612.000 in

Layer 7 is stiff clay without free water
Distance from top of pile to top of layer = 612.000 in

42 inch pipe - stratum 1 through 4.1po
 Distance from top of pile to bottom of layer = 828.000 in

Layer 8 is stiff clay without free water
 Distance from top of pile to top of layer = 828.000 in
 Distance from top of pile to bottom of layer = 1212.000 in

Layer 9 is stiff clay without free water
 Distance from top of pile to top of layer = 1212.000 in
 Distance from top of pile to bottom of layer = 1356.000 in

Layer 10 is stiff clay without free water
 Distance from top of pile to top of layer = 1356.000 in
 Distance from top of pile to bottom of layer = 1692.000 in

(Depth of lowest layer extends 2.00 in below pile tip)

 Effective Unit Weight of Soil vs. Depth

Distribution of effective unit weight of soil with depth
 is defined using 20 points

Point No.	Depth X in	Eff. Unit Weight lbs/in**3
1	.00	.03160
2	36.00	.03160
3	36.00	.03330
4	180.00	.03330
5	180.00	.03160
6	204.00	.03160
7	204.00	.03480
8	276.00	.03480
9	276.00	.03250
10	516.00	.03250
11	516.00	.03620
12	612.00	.03620
13	612.00	.03550
14	828.00	.03550
15	828.00	.03110
16	1212.00	.03110
17	1212.00	.03040
18	1356.00	.03040
19	1356.00	.03450
20	1692.00	.03450

 Shear Strength of Soils

Distribution of shear strength parameters with depth
 defined using 20 points

Point No.	Depth X in	Cohesion c lbs/in**2	Angle of Friction Deg.	E50 or k_rm	RQD %
1	.000	1.38890	15.00	.02000	.0
2	36.000	1.38890	15.00	.02000	.0

42 inch pipe - stratum 1 through 4.1po						
3	36.000	2.20140	.00	.02000	.0	
4	180.000	2.20140	.00	.02000	.0	
5	180.000	1.38890	15.00	.02000	.0	
6	204.000	1.38890	15.00	.02000	.0	
7	204.000	3.12500	.00	.02000	.0	
8	276.000	3.12500	.00	.02000	.0	
9	276.000	4.16670	.00	.01000	.0	
10	516.000	7.63890	.00	.00700	.0	
11	516.000	7.63890	.00	.00700	.0	
12	612.000	7.63890	.00	.00700	.0	
13	612.000	9.59030	.00	.00700	.0	
14	828.000	9.59030	.00	.00700	.0	
15	828.000	7.84720	.00	.00700	.0	
16	1212.000	7.84720	.00	.00700	.0	
17	1212.000	10.59030	.00	.00700	.0	
18	1356.000	10.59030	.00	.00700	.0	
19	1356.000	14.34720	.00	.00500	.0	
20	1692.000	14.34720	.00	.00500	.0	

Notes:

- (1) Cohesion = uniaxial compressive strength for rock materials.
- (2) Values of E50 are reported for clay strata.
- (3) Default values will be generated for E50 when input values are 0.
- (4) RQD and k_{rm} are reported only for weak rock strata.

Loading Type

Cyclic loading criteria was used for computation of p-y curves

Number of cycles of loading = 1000.

Pile-head Loading and Pile-head Fixity Conditions

Number of loads specified = 1

Load Case Number 1

Pile-head boundary conditions are Shear and Moment (BC Type 1)

Shear force at pile head = 1000.000 lbs
Bending moment at pile head = 1000.000 in-lbs
Axial load at pile head = 1000.000 lbs

Non-zero moment at pile head for this load case indicates the pile-head may rotate under the applied pile-head loading, but is not a free-head (zero moment) condition.

Output of p-y Curves at Specified Depths

42 inch pipe - stratum 1 through 4.1po

p-y curves are generated and printed for verification at 8 depths.

Depth No.	Depth Below Pile Head in	Depth Below Ground Surface in
1	18.000	18.000
2	48.000	48.000
3	108.000	108.000
4	168.000	168.000
5	192.000	192.000
6	216.000	216.000
7	240.000	240.000
8	264.000	264.000

Depth of ground surface below top of pile = .00 in

Eq.	3.65	31.0678
Eq.	3.66	110.3576
Eq.	3.67	3.6238
Eq.	3.67	211.3911
Eq.	3.69	239.4852
Eq.	3.75	-3.6602
Eq.	3.76	329.9202
Eq.	3.77	.4183

p-y Curve Computed Using the Cyclic Criteria for Cemented Silt

Soil Layer Number	=	1
Depth below pile head	=	18.000 in
Depth below ground surface	=	18.000in
Equivalent Depth	=	18.000in
Pile Diameter	=	42.000in
Cohesion, c	=	1.389lbs/in**2
Angle of Friction	=	15.000 deg.
Avg. Eff. Unit Weight	=	.03160lbs/in**3
k (internal default)	=	55.600lbs/in**3
E50 (internal default)	=	.02000
A parameter	=	.90429
B parameter	=	.69286
Pu	=	211.391lbs/in
Pc	=	31.068lbs/in
Number of Cycles of Loading	=	1000.
p-multiplier	=	1.00000
y-multiplier	=	1.00000
Pu,c	=	211.391lbs/in
Pc,phi	=	31.068lbs/in

y, in	p, lbs/in
0.0000	0.0000
.0583333	58.3800
.1166667	116.7600
.1750000	175.1400
.2333333	233.5200
.2916667	291.9000
.3500000	350.2800
.4083333	408.6600
.4666667	406.2925
.5250000	393.4265
.5833333	382.2630
.6416667	372.4375

	42 inch pipe - stratum 1 through 4.1po
.7000000	363.6883
1.5750	239.4852
43.5750	239.4852
85.5750	239.4852
127.5750	239.4852

p-y Curve Computed Using the Soft Clay Criteria for Cyclic Loading Conditions

Soil Layer Number	=	2
Depth below pile head	=	48.000 in
Depth below ground surface	=	48.000 in
Equivalent Depth	=	40.081 in
Pile Diameter	=	42.000 in
Cohesion, c	=	2.201 lbs/in**2
Avg Eff Unit Weight	=	.03203 lbs/in**3
E50 parameter	=	.02000
Default J parameter	=	.500
Y50	=	2.10000 in
p-multiplier	=	1.00000
y-multiplier	=	1.00000
Number of cycles of loading	=	1000.
Xr	=	226.823 in

y, in	p, lbs/in
0.0000	0.0000
.0168000	39.4772
.5250000	124.3455
1.0500	156.6655
1.5750	179.3373
2.1000	197.3862
2.6250	212.6278
3.1500	225.9508
3.6750	237.8644
4.2000	248.6910
4.7250	258.6491
5.2500	267.8943
5.7750	276.5420
6.3000	284.2361
16.8000	186.7321
31.5000	50.2263
42.0000	50.2263

p-y Curve Computed Using the Soft Clay Criteria for Cyclic Loading Conditions

Soil Layer Number	=	2
Depth below pile head	=	108.000 in
Depth below ground surface	=	108.000 in
Equivalent Depth	=	100.081 in
Pile Diameter	=	42.000 in
Cohesion, c	=	2.201 lbs/in**2
Avg Eff Unit Weight	=	.03273 lbs/in**3
E50 parameter	=	.02000
Default J parameter	=	.500
Y50	=	2.10000 in
p-multiplier	=	1.00000
y-multiplier	=	1.00000
Number of cycles of loading	=	1000.

42 inch pipe - stratum 1 through 4.lpo

Eq. 3.66 1224.6437
 Eq. 3.67 8.9111
 Eq. 3.67 519.8206
 Eq. 3.69 1113.9043
 Eq. 3.75 -3.3789
 Eq. 3.76 1590.8358
 Eq. 3.77 .2573

p-y Curve Computed Using the Cyclic Criteria for Cemented Silt

Soil Layer Number = 3
 Depth below pile head = 192.000 in
 Depth below ground surface = 192.000in
 Equivalent Depth = 166.162in
 Pile Diameter = 42.000in
 Cohesion, c = 1.389lbs/in**2
 Angle of Friction = 15.000 deg.
 Avg. Eff. Unit Weight = .03288lbs/in**3
 k (internal default) = 55.600lbs/in**3
 E50 (internal default) = .02000
 A parameter = .90175
 B parameter = .55656
 Pu = 519.821lbs/in
 Pc = 658.812lbs/in
 Number of Cycles of Loading = 1000.
 p-multiplier = 1.00000
 y-multiplier = 1.00000
 Pu,c = 519.821lbs/in
 Pc,phi = 658.812lbs/in

y, in	p, lbs/in
0.0000	0.0000
.0583333	538.9185
.1166667	1077.8370
.1750000	1616.7555
.2333333	2155.6740
.2916667	2290.8435
.3500000	2170.5072
.4083333	2073.7095
.4666667	1993.3559
.5250000	1925.0674
.5833333	1865.9660
.6416667	1814.0670
.7000000	1767.9483
1.5750	1113.9043
43.5750	1113.9043
85.5750	1113.9043
127.5750	1113.9043

p-y Curve Computed Using the Soft Clay Criteria for Cyclic Loading Conditions

Soil Layer Number = 4
 Depth below pile head = 216.000 in
 Depth below ground surface = 216.000 in
 Equivalent Depth = 304.913 in
 Pile Diameter = 42.000 in
 Cohesion, c = 3.125 lbs/in**2

42 inch pipe - stratum 1 through 4.1po

```

Avg Eff Unit Weight = .03291 lbs/in**3
E50 parameter = .02000
Default J parameter = .500
Y50 = 2.10000 in
p-multiplier = 1.00000
y-multiplier = 1.00000
Number of cycles of loading = 1000.
Xr = 267.424 in

```

y, in	p, lbs/in
0.0000	0.0000
.0168000	102.9820
.5250000	324.3728
1.0500	408.6842
1.5750	467.8266
2.1000	514.9098
2.6250	554.6698
3.1500	589.4246
3.6750	620.5029
4.2000	648.7457
4.7250	674.7227
5.2500	698.8401
5.7750	721.3988
6.3000	741.4701
16.8000	741.4701
31.5000	741.4701
42.0000	741.4701

p-y Curve Computed Using the Soft Clay Criteria for Cyclic Loading Conditions

```

Soil Layer Number = 4
Depth below pile head = 240.000 in
Depth below ground surface = 240.000 in
Equivalent Depth = 328.913 in
Pile Diameter = 42.000 in
Cohesion, c = 3.125 lbs/in**2
Avg Eff Unit Weight = .03310 lbs/in**3
E50 parameter = .02000
Default J parameter = .500
Y50 = 2.10000 in
p-multiplier = 1.00000
y-multiplier = 1.00000
Number of cycles of loading = 1000.
Xr = 266.705 in

```

y, in	p, lbs/in
0.0000	0.0000
.0168000	110.2398
.5250000	347.2336
1.0500	437.4869
1.5750	500.7975
2.1000	551.1990
2.6250	593.7611
3.1500	630.9653
3.6750	664.2340
4.2000	694.4672
4.7250	722.2750
5.2500	748.0921
5.7750	772.2406
6.3000	793.7266

	42 inch pipe - stratum 1 through 4.lpo
16.8000	793.7266
31.5000	793.7266
42.0000	793.7266

p-y Curve Computed Using the Soft Clay Criteria for Cyclic Loading Conditions

Soil Layer Number	=	4
Depth below pile head	=	264.000 in
Depth below ground surface	=	264.000 in
Equivalent Depth	=	352.913 in
Pile Diameter	=	42.000 in
Cohesion, c	=	3.125 lbs/in**2
Avg Eff Unit Weight	=	.03325 lbs/in**3
E50 parameter	=	.02000
Default J parameter	=	.500
Y50	=	2.10000 in
p-multiplier	=	1.00000
y-multiplier	=	1.00000
Number of cycles of loading	=	1000.
Xr	=	266.120 in

y, in	p, lbs/in
0.0000	0.0000
.0168000	117.4976
.5250000	370.0944
1.0500	466.2897
1.5750	533.7685
2.1000	587.4882
2.6250	632.8525
3.1500	672.5061
3.6750	707.9651
4.2000	740.1888
4.7250	769.8273
5.2500	797.3442
5.7750	823.0825
6.3000	845.9830
16.8000	845.9830
31.5000	845.9830
42.0000	845.9830

 Computed Values of Load Distribution and Deflection
 for Lateral Loading for Load Case Number 1

Pile-head boundary conditions are Shear and Moment (BC Type 1)
 Specified shear force at pile head = 1000.000 lbs
 Specified moment at pile head = 1000.000 in-lbs
 Specified axial load at pile head = 1000.000 lbs

Non-zero moment for this load case indicates the pile-head may rotate under the applied pile-head loading, but is not a free-head (zero moment) condition.

Depth	Deflect.	Moment	Shear	Slope	Total	Soil Res.
Es*h	y	M	V	S	Stress	p
F/L	X					

in lbs/in	in	42 inch lbs-in	pipe - stratum 1 through lbs	4.1po Rad.	lbs/in**2	lbs/in
0.000	.029190	1000.0000	1000.0000	-.0005368	15.4749	0.0000
0.0000						
16.900	.020149	17909.0413	840.0185	-.0005020	17.7996	-18.9327
15879.9160						
33.800	.012224	29409.5904	485.9225	-.0004147	19.3808	-22.9721
31759.8320						
50.700	.006132	34347.2376	49.2548	-.0002971	20.0596	-28.7045
79111.5323						
67.600	.002181	31084.4471	-383.2895	-.0001765	19.6110	-22.4842
174243.						
84.500	.000167	21398.0182	-603.3664	-7.9697E-05	18.2793	-3.5604
360217.						
101.400	-.000513	10693.3574	-533.0303	-2.0519E-05	16.8076	11.8842
391524.						
118.300	-.000527	3382.2870	-321.2979	5.4369E-06	15.8024	13.1729
422830.						
135.200	-.000329	-166.6949	-135.2332	1.1367E-05	15.3603	8.8466
454137.						
152.100	-.000142	-1188.9800	-25.9363	8.8666E-06	15.5009	4.0879
485443.						
169.000	-2.95E-05	-1043.6430	16.2344	4.7496E-06	15.4809	.9027072
516750.						
185.900	1.82E-05	-640.4188	22.4920	1.6441E-06	15.4255	-.1621576
150401.						
202.800	2.60E-05	-283.4685	18.9561	-5.9566E-08	15.3764	-.2562932
166280.						
219.700	1.62E-05	.2996135	10.5376	-5.8174E-07	15.3375	-.7399834
771588.						
236.600	6.39E-06	72.7210	1.7002	-4.4709E-07	15.3474	-.3058611
809468.						
253.500	1.10E-06	57.7809	-1.3488	-2.0644E-07	15.3454	-.0549664
847348.						
270.400	-5.92E-07	27.1383	-1.5542	-4.9842E-08	15.3412	.0306589
875533.						
287.300	-5.88E-07	5.2504	-.8619495	9.8836E-09	15.3381	.0512651
1472469.						
304.200	-2.58E-07	-1.9960	-.2220886	1.5885E-08	15.3377	.0244581
1603782.						
321.100	-5.15E-08	-2.2567	.0292223	8.0428E-09	15.3377	.0052828
1734362.						
338.000	1.41E-08	-1.0085	.0609014	2.0216E-09	15.3376	-.0015338
1836160.						
354.900	1.69E-08	-.1983227	.0315949	-2.0383E-10	15.3375	-.0019344
1939740.						
371.800	7.23E-09	.0594012	.0078580	-4.6001E-10	15.3374	-.0008747
2045190.						
388.700	1.31E-09	.0672947	-.0009379	-2.2638E-10	15.3374	-.0001662
2152606.						
405.600	-4.23E-10	.0277065	-.0018636	-5.1190E-11	15.3374	5.6683E-05
2262088.						
422.500	-4.25E-10	.0043058	-.0008801	7.8417E-12	15.3374	5.9715E-05
2373749.						
439.400	-1.58E-10	-.0020401	-.0001784	1.2020E-11	15.3374	2.3321E-05
2487708.						
456.300	-1.89E-11	-.0017250	4.3224E-05	5.0767E-12	15.3374	2.9083E-06
2604096.						
473.200	1.32E-11	-.0005793	4.9877E-05	8.2753E-13	15.3374	-2.1210E-06
2723054.						
490.100	9.10E-12	-3.9225E-05	1.9016E-05	-3.1298E-13	15.3374	-1.5312E-06

42 inch pipe - stratum 1 through 4.lpo

2844737.						
507.000	2.58E-12	6.3495E-05	2.2403E-06	-2.6822E-13	15.3374	-4.5413E-07
2969314.						
523.900	3.04E-14	3.6506E-05	-1.6721E-06	-8.3820E-14	15.3374	-8.8777E-09
4927737.						
540.800	-2.48E-13	6.9801E-06	-1.1145E-06	-3.6298E-15	15.3374	7.4868E-08
5093115.						
557.700	-9.22E-14	-1.1634E-06	-2.3932E-07	7.0964E-15	15.3374	2.8702E-08
5258586.						
574.600	-8.57E-15	-1.1093E-06	2.6092E-08	2.9055E-15	15.3374	2.7083E-09
5340698.						
591.500	5.96E-15	-2.8158E-07	3.3055E-08	3.4066E-16	15.3374	-1.8842E-09
5340698.						
608.400	2.94E-15	7.9708E-09	9.2711E-09	-1.6389E-16	15.3374	-9.3044E-10
5340698.						
625.300	4.23E-16	3.1784E-08	4.2017E-11	-9.0586E-17	15.3374	-1.6176E-10
6465493.						
642.200	-1.18E-16	9.3940E-09	-9.3343E-10	-1.4652E-17	15.3374	4.6326E-11
6660935.						
659.100	-7.24E-17	2.3457E-10	-2.9926E-10	3.1036E-18	15.3374	2.8724E-11
6705010.						
676.000	-1.26E-17	-7.2107E-10	-1.4177E-11	2.2065E-18	15.3374	5.0138E-12
6705010.						
692.900	2.18E-18	-2.4467E-10	2.0880E-11	4.2561E-19	15.3374	-8.6507E-13
6705010.						
709.800	1.75E-18	-1.5328E-11	7.7093E-12	-5.3835E-20	15.3374	-6.9363E-13
6705010.						
726.700	3.61E-19	1.5906E-11	6.3853E-13	-5.2770E-20	15.3374	-1.4315E-13
6705010.						
743.600	-3.53E-20	6.2556E-12	-4.5268E-13	-1.1903E-20	15.3374	1.4009E-14
6705010.						
760.500	-4.15E-20	6.0580E-13	-1.9514E-13	7.4996E-22	15.3374	1.6470E-14
6705010.						
777.400	-9.96E-21	-3.3996E-13	-2.2569E-14	1.2402E-21	15.3374	3.9516E-15
6705010.						
794.300	4.05E-22	-1.5708E-13	9.4657E-15	3.2363E-22	15.3374	-1.6049E-16
6705010.						
811.200	9.79E-22	-2.0027E-14	4.8289E-15	-2.9621E-24	15.3374	-3.8825E-16
6705010.						
828.100	3.04E-22	6.1370E-15	7.1315E-16	-2.8576E-23	15.3374	-9.8817E-17
5486330.						
845.000	1.27E-23	4.0780E-15	-1.5671E-16	-9.7396E-24	15.3374	-4.1252E-18
5486330.						
861.900	-2.48E-23	8.4058E-16	-1.2353E-16	-6.6951E-25	15.3374	8.0521E-18
5486330.						
878.800	-9.92E-24	-9.7150E-17	-2.8267E-17	7.0140E-25	15.3374	3.2211E-18
5486330.						
895.700	-1.10E-24	-1.1488E-16	1.9586E-18	3.1040E-25	15.3374	3.5590E-19
5486330.						
912.600	5.69E-25	-3.0961E-17	3.4044E-18	0.0000	15.3374	-1.8480E-19
5486330.						
929.500	3.05E-25	1.8288E-19	1.0059E-18	0.0000	15.3374	-9.9038E-20
5486330.						
946.400	0.000	3.0404E-18	2.5614E-20	0.0000	15.3374	-1.6977E-20
5486330.						
963.300	0.000	1.0490E-18	-8.7715E-20	0.0000	15.3374	3.5651E-21
5486330.						
980.200	0.000	7.5693E-20	-3.3232E-20	0.0000	15.3374	2.8826E-21
5486330.						
997.100	0.000	-7.4283E-20	-3.2254E-21	0.0000	15.3374	6.6847E-22
5486330.						
1014.	0.000	-3.3334E-20	2.0631E-21	0.0000	15.3374	-4.2609E-23
5486330.						

42 inch pipe - stratum 1 through 4.1po

1031.	0.000	-4.5525E-21	1.0338E-21	0.0000	15.3374	-7.9206E-23
5486330.						
1048.	0.000	1.6074E-21	1.6431E-22	0.0000	15.3374	-2.3689E-23
5486330.						
1065.	0.000	1.0015E-21	-4.1737E-23	0.0000	15.3374	-6.9572E-25
5486330.						
1082.	0.000	1.9679E-22	-3.0436E-23	0.0000	15.3374	2.0331E-24
5486330.						
1099.	0.000	-2.7240E-23	-6.6645E-24	0.0000	15.3374	7.8007E-25
5486330.						
1115.	0.000	-2.8473E-23	5.8796E-25	0.0000	15.3374	0.0000
5486330.						
1132.	0.000	-7.3694E-24	8.4690E-25	0.0000	15.3374	0.0000
5486330.						
1149.	0.000	1.5194E-25	2.4057E-25	0.0000	15.3374	0.0000
5486330.						
1166.	0.000	7.6180E-25	0.0000	0.0000	15.3374	0.0000
5486330.						
1183.	0.000	2.5296E-25	0.0000	0.0000	15.3374	0.0000
5486330.						
1200.	0.000	0.0000	0.0000	0.0000	15.3374	0.0000
5486330.						
1217.	0.000	0.0000	0.0000	0.0000	15.3374	0.0000
7404154.						
1234.	0.000	0.0000	0.0000	0.0000	15.3374	0.0000
7404154.						
1251.	0.000	0.0000	0.0000	0.0000	15.3374	0.0000
7404154.						
1268.	0.000	0.0000	0.0000	0.0000	15.3374	0.0000
7404154.						
1284.	0.000	0.0000	0.0000	0.0000	15.3374	0.0000
7404154.						
1301.	0.000	0.0000	0.0000	0.0000	15.3374	0.0000
7404154.						
1318.	0.000	0.0000	0.0000	0.0000	15.3374	0.0000
7404154.						
1335.	0.000	0.0000	0.0000	0.0000	15.3374	0.0000
7404154.						
1352.	0.000	0.0000	0.0000	0.0000	15.3374	0.0000
7404154.						
1369.	0.000	0.0000	0.0000	0.0000	15.3374	0.0000
1.0911E+07						
1386.	0.000	0.0000	0.0000	0.0000	15.3374	0.0000
1.0911E+07						
1403.	0.000	0.0000	0.0000	0.0000	15.3374	0.0000
1.0911E+07						
1420.	0.000	0.0000	0.0000	0.0000	15.3374	0.0000
1.0911E+07						
1436.	0.000	0.0000	0.0000	0.0000	15.3374	0.0000
1.0911E+07						
1453.	0.000	0.0000	0.0000	0.0000	15.3374	0.0000
1.0911E+07						
1470.	0.000	0.0000	0.0000	0.0000	15.3374	0.0000
1.0911E+07						
1487.	0.000	0.0000	0.0000	0.0000	15.3374	0.0000
1.0911E+07						
1504.	0.000	0.0000	0.0000	0.0000	15.3374	0.0000
1.0911E+07						
1521.	0.000	0.0000	0.0000	0.0000	15.3374	0.0000
1.0911E+07						
1538.	0.000	0.0000	0.0000	0.0000	15.3374	0.0000
1.0911E+07						
1555.	0.000	0.0000	0.0000	0.0000	15.3374	0.0000

42 inch pipe - stratum 1 through 4.1po

1.0911E+07						
1572.	0.000	0.0000	0.0000	0.0000	15.3374	0.0000
1.0911E+07						
1589.	0.000	0.0000	0.0000	0.0000	15.3374	0.0000
1.0911E+07						
1605.	0.000	0.0000	0.0000	0.0000	15.3374	0.0000
1.0911E+07						
1622.	0.000	0.0000	0.0000	0.0000	15.3374	0.0000
1.0911E+07						
1639.	0.000	0.0000	0.0000	0.0000	15.3374	0.0000
1.0911E+07						
1656.	0.000	0.0000	0.0000	0.0000	15.3374	0.0000
1.0911E+07						
1673.	0.000	0.0000	0.0000	0.0000	15.3374	0.0000
1.0911E+07						
1690.	0.000	0.0000	0.0000	0.0000	15.3374	0.0000
5455523.						

Output Verification:

Computed forces and moments are within specified convergence limits.

Output Summary for Load Case No. 1:

Pile-head deflection	=	.02919017 in
Computed slope at pile head	=	-.00053683
Maximum bending moment	=	34347.23764 lbs-in
Maximum shear force	=	1000.00000 lbs
Depth of maximum bending moment	=	50.70000000 in
Depth of maximum shear force	=	0.00000 in
Number of iterations	=	9
Number of zero deflection points	=	29

 Summary of Pile Response(s)

Definition of symbols for Pile-Head Loading Conditions:

Type 1 = Shear and Moment,	y = pile-head displacement in
Type 2 = Shear and Slope,	M = Pile-head Moment lbs-in
Type 3 = Shear and Rot. Stiffness,	V = Pile-head Shear Force lbs
Type 4 = Deflection and Moment,	S = Pile-head Slope, radians
Type 5 = Deflection and Slope,	R = Rot. Stiffness of Pile-head in-lbs/rad

Load Type	Pile-Head Condition 1	Pile-Head Condition 2	Axial Load lbs	Pile-Head Deflection in	Maximum Moment in-lbs	Maximum Shear lbs
1	V= 1000.000	M= 1000.000	1000.0000	.0291902	34347.2376	1000.0000

The analysis ended normally.

42 inch pipe - stratum 5 through 7.lpo

LPILE Plus for windows, Version 5.0 (5.0.30)

Analysis of Individual Piles and Drilled Shafts
Subjected to Lateral Loading Using the p-y Method

(c) 1985-2007 by Ensoft, Inc.
All Rights Reserved

This program is licensed to:

DJI
Eustis

Path to file locations: U:\sys\WPDATA\Projects\20749\Piles\LPile\
Name of input data file: 42 inch pipe - stratum 5 through 7.lpd
Name of output file: 42 inch pipe - stratum 5 through 7.lpo
Name of plot output file: 42 inch pipe - stratum 5 through 7.lpp
Name of runtime file: 42 inch pipe - stratum 5 through 7.lpr

Time and Date of Analysis

Date: November 9, 2009 Time: 17:31:26

Problem Title

EE20749 - St. Mary Floodgate Structure at Franklin Drainage Canal

Program Options

Units Used in Computations - US Customary Units: Inches, Pounds

Basic Program Options:

Analysis Type 1:

- Computation of Lateral Pile Response Using User-specified Constant EI

Computation Options:

- Only internally-generated p-y curves used in analysis
- Analysis does not use p-y multipliers (individual pile or shaft action only)
- Analysis assumes no shear resistance at pile tip
- Analysis for fixed-length pile or shaft only
- No computation of foundation stiffness matrix elements
- Output pile response for full length of pile
- Analysis assumes no soil movements acting on pile
- Additional p-y curves computed at specified depths

Solution Control Parameters:

- Number of pile increments = 100
- Maximum number of iterations allowed = 100

42 inch pipe - stratum 5 through 7.lpo

- Deflection tolerance for convergence = 1.0000E-05 in
- Maximum allowable deflection = 1.0000E+02 in

Printing Options:

- Values of pile-head deflection, bending moment, shear force, and soil reaction are printed for full length of pile.
- Printing Increment (spacing of output points) = 1

Pile Structural Properties and Geometry

Pile Length = 1690.00 in
Depth of ground surface below top of pile = .00 in
Slope angle of ground surface = .00 deg.

Structural properties of pile defined using 2 points

Point	Depth X in	Pile Diameter in	Moment of Inertia in**4	Pile Area Sq.in	Modulus of Elasticity lbs/Sq.in
1	0.0000	42.00000000	152745.0000	65.2000	30000.00000
2	1690.0000	42.00000000	152745.0000	65.2000	30000.00000

Soil and Rock Layering Information

The soil profile is modelled using 10 layers

Layer 1 is silt with cohesion and friction
Distance from top of pile to top of layer = .000 in
Distance from top of pile to bottom of layer = 36.000 in
p-y subgrade modulus k for top of soil layer = 55.600 lbs/in**3
p-y subgrade modulus k for bottom of layer = 55.600 lbs/in**3

Layer 2 is soft clay, p-y criteria by Matlock, 1970
Distance from top of pile to top of layer = 36.000 in
Distance from top of pile to bottom of layer = 180.000 in

Layer 3 is silt with cohesion and friction
Distance from top of pile to top of layer = 180.000 in
Distance from top of pile to bottom of layer = 204.000 in
p-y subgrade modulus k for top of soil layer = 55.600 lbs/in**3
p-y subgrade modulus k for bottom of layer = 55.600 lbs/in**3

Layer 4 is soft clay, p-y criteria by Matlock, 1970
Distance from top of pile to top of layer = 204.000 in
Distance from top of pile to bottom of layer = 276.000 in

Layer 5 is soft clay, p-y criteria by Matlock, 1970
Distance from top of pile to top of layer = 276.000 in
Distance from top of pile to bottom of layer = 516.000 in

Layer 6 is stiff clay without free water
Distance from top of pile to top of layer = 516.000 in
Distance from top of pile to bottom of layer = 612.000 in

Layer 7 is stiff clay without free water
Distance from top of pile to top of layer = 612.000 in

42 inch pipe - stratum 5 through 7.1po
 Distance from top of pile to bottom of layer = 828.000 in
 Layer 8 is stiff clay without free water
 Distance from top of pile to top of layer = 828.000 in
 Distance from top of pile to bottom of layer = 1212.000 in
 Layer 9 is stiff clay without free water
 Distance from top of pile to top of layer = 1212.000 in
 Distance from top of pile to bottom of layer = 1356.000 in
 Layer 10 is stiff clay without free water
 Distance from top of pile to top of layer = 1356.000 in
 Distance from top of pile to bottom of layer = 1692.000 in

(Depth of lowest layer extends 2.00 in below pile tip)

 Effective Unit Weight of Soil vs. Depth

Distribution of effective unit weight of soil with depth
 is defined using 20 points

Point No.	Depth X in	Eff. Unit Weight lbs/in**3
1	.00	.03160
2	36.00	.03160
3	36.00	.03330
4	180.00	.03330
5	180.00	.03160
6	204.00	.03160
7	204.00	.03480
8	276.00	.03480
9	276.00	.03250
10	516.00	.03250
11	516.00	.03620
12	612.00	.03620
13	612.00	.03550
14	828.00	.03550
15	828.00	.03110
16	1212.00	.03110
17	1212.00	.03040
18	1356.00	.03040
19	1356.00	.03450
20	1692.00	.03450

 Shear Strength of soils

Distribution of shear strength parameters with depth
 defined using 20 points

Point No.	Depth X in	Cohesion c lbs/in**2	Angle of Friction Deg.	E50 or k_rm	RQD %
1	.000	1.38890	15.00	.02000	.0
2	36.000	1.38890	15.00	.02000	.0

42 inch pipe - stratum 5 through 7.1po					
3	36.000	2.20140	.00	.02000	.0
4	180.000	2.20140	.00	.02000	.0
5	180.000	1.38890	15.00	.02000	.0
6	204.000	1.38890	15.00	.02000	.0
7	204.000	3.12500	.00	.02000	.0
8	276.000	3.12500	.00	.02000	.0
9	276.000	4.16670	.00	.01000	.0
10	516.000	7.63890	.00	.00700	.0
11	516.000	7.63890	.00	.00700	.0
12	612.000	7.63890	.00	.00700	.0
13	612.000	9.59030	.00	.00700	.0
14	828.000	9.59030	.00	.00700	.0
15	828.000	7.84720	.00	.00700	.0
16	1212.000	7.84720	.00	.00700	.0
17	1212.000	10.59030	.00	.00700	.0
18	1356.000	10.59030	.00	.00700	.0
19	1356.000	14.34720	.00	.00500	.0
20	1692.000	14.34720	.00	.00500	.0

Notes:

- (1) Cohesion = uniaxial compressive strength for rock materials.
- (2) Values of E50 are reported for clay strata.
- (3) Default values will be generated for E50 when input values are 0.
- (4) RQD and k_{rm} are reported only for weak rock strata.

Loading Type

Cyclic loading criteria was used for computation of p-y curves

Number of cycles of loading = 1000.

Pile-head Loading and Pile-head Fixity Conditions

Number of loads specified = 1

Load Case Number 1

Pile-head boundary conditions are Shear and Moment (BC Type 1)

Shear force at pile head = 1000.000 lbs
 Bending moment at pile head = 1000.000 in-lbs
 Axial load at pile head = 1000.000 lbs

Non-zero moment at pile head for this load case indicates the pile-head may rotate under the applied pile-head loading, but is not a free-head (zero moment) condition.

Output of p-y Curves at Specified Depths

42 inch pipe - stratum 5 through 7.1po

p-y curves are generated and printed for verification at 9 depths.

Depth No.	Depth Below Pile Head in	Depth Below Ground Surface in
1	288.000	288.000
2	396.000	396.000
3	504.000	504.000
4	528.000	528.000
5	564.000	564.000
6	600.000	600.000
7	624.000	624.000
8	720.000	720.000
9	816.000	816.000

Depth of ground surface below top of pile = .00 in

p-y Curve Computed Using the Soft Clay Criteria for Cyclic Loading Conditions

Soil Layer Number = 5
 Depth below pile head = 288.000 in
 Depth below ground surface = 288.000 in
 Equivalent Depth = 344.139 in
 Pile Diameter = 42.000 in
 Cohesion, c = 4.340 lbs/in**2
 Avg Eff Unit Weight = .03329 lbs/in**3
 E50 parameter = .00985
 Default J parameter = .500
 Y50 = 1.03425 in
 p-multiplier = 1.00000
 y-multiplier = 1.00000
 Number of cycles of loading = 1000.
 Xr = 306.527 in

y, in	p, lbs/in
0.0000	0.0000
.0082740	157.4529
.2585625	495.9456
.5171250	624.8524
.7756875	715.2774
1.0342	787.2646
1.2928	848.0551
1.5514	901.1931
1.8099	948.7099
2.0685	991.8913
2.3271	1031.6085
2.5856	1068.4825
2.8442	1102.9733
3.1027	1133.6611
8.2740	1133.6611
15.5137	1133.6611
20.6850	1133.6611

p-y Curve Computed Using the Soft Clay Criteria for Cyclic Loading Conditions

Soil Layer Number = 5
 Depth below pile head = 396.000 in
 Depth below ground surface = 396.000 in
 Page 5

42 inch pipe - stratum 5 through 7.lpo

```

Equivalent Depth      = 452.139 in
Pile Diameter         = 42.000 in
Cohesion, c          = 5.903 lbs/in**2
Avg Eff Unit Weight   = .03307 lbs/in**3
E50 parameter         = .00850
Default J parameter   = .500
Y50                   = .89250 in
p-multiplier          = 1.00000
y-multiplier          = 1.00000
Number of cycles of loading = 1000.
Xr                     = 342.707 in

```

y, in	p, lbs/in
0.0000	0.0000
.0071400	223.1258
.2231250	702.8023
.4462500	885.4755
.6693750	1013.6164
.8925000	1115.6292
1.1156	1201.7751
1.3388	1277.0766
1.5619	1344.4126
1.7850	1405.6047
2.0081	1461.8878
2.2313	1514.1418
2.4544	1563.0185
2.6775	1609.0158
7.1400	1606.5061
13.3875	1606.5061
17.8500	1606.5061

p-y Curve Computed Using the Soft Clay Criteria for Cyclic Loading Conditions

```

Soil Layer Number     = 5
Depth below pile head = 504.000 in
Depth below ground surface = 504.000 in
Equivalent Depth      = 560.139 in
Pile Diameter         = 42.000 in
Cohesion, c          = 7.465 lbs/in**2
Avg Eff Unit Weight   = .03295 lbs/in**3
E50 parameter         = .00715
Default J parameter   = .500
Y50                   = .75075 in
p-multiplier          = 1.00000
y-multiplier          = 1.00000
Number of cycles of loading = 1000.
Xr                     = 367.680 in

```

y, in	p, lbs/in
0.0000	0.0000
.0060060	282.1880
.1876875	888.8364
.3753750	1119.8637
.5630625	1281.9239
.7507500	1410.9398
.9384375	1519.8888
1.1261	1615.1229
1.3138	1700.2828
1.5015	1777.6728
1.6892	1848.8542

	42 inch pipe - stratum 5 through 7.1po
1.8769	1914.9400
2.0646	1976.7544
2.2523	2034.9274
6.0060	2031.7534
11.2613	2031.7534
15.0150	2031.7534

p-y Curve Computed Using Cyclic Criteria for Stiff Clay without Free Water

Soil Layer Number	=	6
Depth below pile head	=	528.000 in
Depth below ground surface	=	528.000 in
Equivalent Depth	=	331.043 in
Diameter	=	42.000 in
Undrained cohesion, c	=	7.63890 lbs/in**2
Average Eff. Unit Weight	=	.03301 lbs/in**3
Epsilon-50	=	.00700
Pct	=	2685.920 lbs/in
Pcd	=	2887.504 lbs/in
Pu	=	2685.920 lbs/in
y50	=	.735 in
p-multiplier	=	1.00000
y-multiplier	=	1.00000
Number of cycles of loading	=	1000.

y, in	p, lbs/in
0.0000	0.0000
.0001176	116.7625
.0005880	174.6007
.0011760	207.6364
.0058800	310.4889
.0117600	369.2356
.0588000	552.1359
.1176000	656.6040
.2940000	825.6358
.5880000	981.8520
.8820000	1086.5978
1.1760	1167.6253
2.9400	1468.2111
5.8800	1746.0071
11.7600	2076.3641
26.4600	2543.0163
41.1600	2685.9197

p-y Curve Computed Using Cyclic Criteria for Stiff Clay without Free Water

Soil Layer Number	=	6
Depth below pile head	=	564.000 in
Depth below ground surface	=	564.000 in
Equivalent Depth	=	367.043 in
Diameter	=	42.000 in
Undrained cohesion, c	=	7.63890 lbs/in**2
Average Eff. Unit Weight	=	.03322 lbs/in**3
Epsilon-50	=	.00700
Pct	=	2876.472 lbs/in
Pcd	=	2887.504 lbs/in
Pu	=	2876.472 lbs/in

Page 7

42 inch pipe - stratum 5 through 7.1po
y50 = .735 in
p-multiplier = 1.00000
y-multiplier = 1.00000
Number of cycles of loading = 1000.

y, in	p, lbs/in
0.0000	0.0000
.0001176	125.0462
.0005880	186.9877
.0011760	222.3671
.0058800	332.5164
.0117600	395.4309
.0588000	591.3071
.1176000	703.1866
.2940000	884.2104
.5880000	1051.5093
.8820000	1163.6863
1.1760	1250.4623
2.9400	1572.3732
5.8800	1869.8773
11.7600	2223.6714
26.4600	2723.4302
41.1600	2876.4719

p-y Curve Computed Using Cyclic Criteria for Stiff Clay without Free Water

Soil Layer Number = 6
Depth below pile head = 600.000 in
Depth below ground surface = 600.000 in
Equivalent Depth = 403.043 in
Diameter = 42.000 in
Undrained cohesion, c = 7.63890 lbs/in**2
Average Eff. Unit Weight = .03340 lbs/in**3
Epsilon-50 = .00700
Pct = 3067.226 lbs/in
Pcd = 2887.504 lbs/in
Pu = 2887.504 lbs/in
y50 = .735 in
p-multiplier = 1.00000
y-multiplier = 1.00000
Number of cycles of loading = 1000.

y, in	p, lbs/in
0.0000	0.0000
.0001176	125.5258
.0005880	187.7049
.0011760	223.2200
.0058800	333.7918
.0117600	396.9475
.0588000	593.5750
.1176000	705.8836
.2940000	887.6017
.5880000	1055.5422
.8820000	1168.1495
1.1760	1255.2583
2.9400	1578.4038
5.8800	1877.0490
11.7600	2232.2001
26.4600	2733.8756
41.1600	2887.5042

42 inch pipe - stratum 5 through 7.lpo

p-y Curve Computed Using Cyclic Criteria for Stiff Clay without Free Water

Soil Layer Number = 7
 Depth below pile head = 624.000 in
 Depth below ground surface = 624.000 in
 Equivalent Depth = 367.498 in
 Diameter = 42.000 in
 Undrained cohesion, c = 9.59030 lbs/in**2
 Average Eff. Unit Weight = .03349 lbs/in**3
 Epsilon-50 = .00700
 Pct = 3487.509 lbs/in
 Pcd = 3625.133 lbs/in
 Pu = 3487.509 lbs/in
 y50 = .735 in
 p-multiplier = 1.00000
 y-multiplier = 1.00000
 Number of cycles of loading = 1000.

y, in	p, lbs/in
0.0000	0.0000
.0001176	151.6093
.0005880	226.7088
.0011760	269.6037
.0058800	403.1516
.0117600	479.4307
.0588000	716.9162
.1176000	852.5618
.2940000	1072.0397
.5880000	1274.8773
.8820000	1410.8836
1.1760	1516.0931
2.9400	1906.3862
5.8800	2267.0880
11.7600	2696.0372
26.4600	3301.9577
41.1600	3487.5094

p-y Curve Computed Using Cyclic Criteria for Stiff Clay without Free Water

Soil Layer Number = 7
 Depth below pile head = 720.000 in
 Depth below ground surface = 720.000 in
 Equivalent Depth = 463.498 in
 Diameter = 42.000 in
 Undrained cohesion, c = 9.59030 lbs/in**2
 Average Eff. Unit Weight = .03376 lbs/in**3
 Epsilon-50 = .00700
 Pct = 4088.093 lbs/in
 Pcd = 3625.133 lbs/in
 Pu = 3625.133 lbs/in
 y50 = .735 in
 p-multiplier = 1.00000
 y-multiplier = 1.00000
 Number of cycles of loading = 1000.

y, in p, lbs/in

42 inch pipe - stratum 5 through 7.1po

0.0000	0.0000
.0001176	157.5921
.0005880	235.6552
.0011760	280.2428
.0058800	419.0608
.0117600	498.3500
.0588000	745.2071
.1176000	886.2056
.2940000	1114.3445
.5880000	1325.1864
.8820000	1466.5599
1.1760	1575.9211
2.9400	1981.6159
5.8800	2356.5518
11.7600	2802.4281
26.4600	3432.2595
41.1600	3625.1334

p-y Curve Computed Using Cyclic Criteria for Stiff Clay without Free Water

Soil Layer Number	=	7
Depth below pile head	=	816.000 in
Depth below ground surface	=	816.000 in
Equivalent Depth	=	559.498 in
Diameter	=	42.000 in
Undrained cohesion, c	=	9.59030 lbs/in**2
Average Eff. Unit Weight	=	.03396 lbs/in**3
Epsilon-50	=	.00700
Pct	=	4689.356 lbs/in
Pcd	=	3625.133 lbs/in
Pu	=	3625.133 lbs/in
y50	=	.735 in
p-multiplier	=	1.00000
y-multiplier	=	1.00000
Number of cycles of loading	=	1000.

y, in	p, lbs/in
0.0000	0.0000
.0001176	157.5921
.0005880	235.6552
.0011760	280.2428
.0058800	419.0608
.0117600	498.3500
.0588000	745.2071
.1176000	886.2056
.2940000	1114.3445
.5880000	1325.1864
.8820000	1466.5599
1.1760	1575.9211
2.9400	1981.6159
5.8800	2356.5518
11.7600	2802.4281
26.4600	3432.2595
41.1600	3625.1334

42 inch pipe - stratum 5 through 7.lpo
 Computed Values of Load Distribution and Deflection
 for Lateral Loading for Load Case Number 1

Pile-head boundary conditions are Shear and Moment (BC Type 1)
 Specified shear force at pile head = 1000.000 lbs
 Specified moment at pile head = 1000.000 in-lbs
 Specified axial load at pile head = 1000.000 lbs

Non-zero moment for this load case indicates the pile-head may rotate under the applied pile-head loading, but is not a free-head (zero moment) condition.

Depth Es*h X F/L in lbs/in	Deflect. y in	Moment M lbs-in	Shear V lbs	Slope S Rad.	Total Stress lbs/in**2	Soil Res. p lbs/in
0.000	.029190	1000.0000	1000.0000	-.0005368	15.4749	0.0000
0.0000						
16.900	.020149	17909.0413	840.0185	-.0005020	17.7996	-18.9327
15879.9160						
33.800	.012224	29409.5904	485.9225	-.0004147	19.3808	-22.9721
31759.8320						
50.700	.006132	34347.2376	49.2548	-.0002971	20.0596	-28.7045
79111.5323						
67.600	.002181	31084.4471	-383.2895	-.0001765	19.6110	-22.4842
174243.						
84.500	.000167	21398.0182	-603.3664	-7.9697E-05	18.2793	-3.5604
360217.						
101.400	-.000513	10693.3574	-533.0303	-2.0519E-05	16.8076	11.8842
391524.						
118.300	-.000527	3382.2870	-321.2979	5.4369E-06	15.8024	13.1729
422830.						
135.200	-.000329	-166.6949	-135.2332	1.1367E-05	15.3603	8.8466
454137.						
152.100	-.000142	-1188.9800	-25.9363	8.8666E-06	15.5009	4.0879
485443.						
169.000	-2.95E-05	-1043.6430	16.2344	4.7496E-06	15.4809	.9027072
516750.						
185.900	1.82E-05	-640.4188	22.4920	1.6441E-06	15.4255	-.1621576
150401.						
202.800	2.60E-05	-283.4685	18.9561	-5.9566E-08	15.3764	-.2562932
166280.						
219.700	1.62E-05	.2996135	10.5376	-5.8174E-07	15.3375	-.7399834
771588.						
236.600	6.39E-06	72.7210	1.7002	-4.4709E-07	15.3474	-.3058611
809468.						
253.500	1.10E-06	57.7809	-1.3488	-2.0644E-07	15.3454	-.0549664
847348.						
270.400	-5.92E-07	27.1383	-1.5542	-4.9842E-08	15.3412	.0306589
875533.						
287.300	-5.88E-07	5.2504	-.8619495	9.8836E-09	15.3381	.0512651
1472469.						
304.200	-2.58E-07	-1.9960	-.2220886	1.5885E-08	15.3377	.0244581
1603782.						
321.100	-5.15E-08	-2.2567	.0292223	8.0428E-09	15.3377	.0052828
1734362.						
338.000	1.41E-08	-1.0085	.0609014	2.0216E-09	15.3376	-.0015338
1836160.						
354.900	1.69E-08	-.1983227	.0315949	-2.0383E-10	15.3375	-.0019344

42 inch pipe - stratum 5 through 7.1po

1939740.						
371.800	7.23E-09	.0594012	.0078580	-4.6001E-10	15.3374	-.0008747
2045190.						
388.700	1.31E-09	.0672947	-.0009379	-2.2638E-10	15.3374	-.0001662
2152606.						
405.600	-4.23E-10	.0277065	-.0018636	-5.1190E-11	15.3374	5.6683E-05
2262088.						
422.500	-4.25E-10	.0043058	-.0008801	7.8417E-12	15.3374	5.9715E-05
2373749.						
439.400	-1.58E-10	-.0020401	-.0001784	1.2020E-11	15.3374	2.3321E-05
2487708.						
456.300	-1.89E-11	-.0017250	4.3224E-05	5.0767E-12	15.3374	2.9083E-06
2604096.						
473.200	1.32E-11	-.0005793	4.9877E-05	8.2753E-13	15.3374	-2.1210E-06
2723054.						
490.100	9.10E-12	-3.9225E-05	1.9016E-05	-3.1298E-13	15.3374	-1.5312E-06
2844737.						
507.000	2.58E-12	6.3495E-05	2.2403E-06	-2.6822E-13	15.3374	-4.5413E-07
2969314.						
523.900	3.04E-14	3.6506E-05	-1.6721E-06	-8.3820E-14	15.3374	-8.8777E-09
4927737.						
540.800	-2.48E-13	6.9801E-06	-1.1145E-06	-3.6298E-15	15.3374	7.4868E-08
5093115.						
557.700	-9.22E-14	-1.1634E-06	-2.3932E-07	7.0964E-15	15.3374	2.8702E-08
5258586.						
574.600	-8.57E-15	-1.1093E-06	2.6092E-08	2.9055E-15	15.3374	2.7083E-09
5340698.						
591.500	5.96E-15	-2.8158E-07	3.3055E-08	3.4066E-16	15.3374	-1.8842E-09
5340698.						
608.400	2.94E-15	7.9708E-09	9.2711E-09	-1.6389E-16	15.3374	-9.3044E-10
5340698.						
625.300	4.23E-16	3.1784E-08	4.2017E-11	-9.0586E-17	15.3374	-1.6176E-10
6465493.						
642.200	-1.18E-16	9.3940E-09	-9.3343E-10	-1.4652E-17	15.3374	4.6326E-11
6660935.						
659.100	-7.24E-17	2.3457E-10	-2.9926E-10	3.1036E-18	15.3374	2.8724E-11
6705010.						
676.000	-1.26E-17	-7.2107E-10	-1.4177E-11	2.2065E-18	15.3374	5.0138E-12
6705010.						
692.900	2.18E-18	-2.4467E-10	2.0880E-11	4.2561E-19	15.3374	-8.6507E-13
6705010.						
709.800	1.75E-18	-1.5328E-11	7.7093E-12	-5.3835E-20	15.3374	-6.9363E-13
6705010.						
726.700	3.61E-19	1.5906E-11	6.3853E-13	-5.2770E-20	15.3374	-1.4315E-13
6705010.						
743.600	-3.53E-20	6.2556E-12	-4.5268E-13	-1.1903E-20	15.3374	1.4009E-14
6705010.						
760.500	-4.15E-20	6.0580E-13	-1.9514E-13	7.4996E-22	15.3374	1.6470E-14
6705010.						
777.400	-9.96E-21	-3.3996E-13	-2.2569E-14	1.2402E-21	15.3374	3.9516E-15
6705010.						
794.300	4.05E-22	-1.5708E-13	9.4657E-15	3.2363E-22	15.3374	-1.6049E-16
6705010.						
811.200	9.79E-22	-2.0027E-14	4.8289E-15	-2.9621E-24	15.3374	-3.8825E-16
6705010.						
828.100	3.04E-22	6.1370E-15	7.1315E-16	-2.8576E-23	15.3374	-9.8817E-17
5486330.						
845.000	1.27E-23	4.0780E-15	-1.5671E-16	-9.7396E-24	15.3374	-4.1252E-18
5486330.						
861.900	-2.48E-23	8.4058E-16	-1.2353E-16	-6.6951E-25	15.3374	8.0521E-18
5486330.						
878.800	-9.92E-24	-9.7150E-17	-2.8267E-17	7.0140E-25	15.3374	3.2211E-18
5486330.						

42 inch pipe - stratum 5 through 7.1po

895.700	-1.10E-24	-1.1488E-16	1.9586E-18	3.1040E-25	15.3374	3.5590E-19
5486330.						
912.600	5.69E-25	-3.0961E-17	3.4044E-18	0.0000	15.3374	-1.8480E-19
5486330.						
929.500	3.05E-25	1.8288E-19	1.0059E-18	0.0000	15.3374	-9.9038E-20
5486330.						
946.400	0.000	3.0404E-18	2.5614E-20	0.0000	15.3374	-1.6977E-20
5486330.						
963.300	0.000	1.0490E-18	-8.7715E-20	0.0000	15.3374	3.5651E-21
5486330.						
980.200	0.000	7.5693E-20	-3.3232E-20	0.0000	15.3374	2.8826E-21
5486330.						
997.100	0.000	-7.4283E-20	-3.2254E-21	0.0000	15.3374	6.6847E-22
5486330.						
1014.	0.000	-3.3334E-20	2.0631E-21	0.0000	15.3374	-4.2609E-23
5486330.						
1031.	0.000	-4.5525E-21	1.0338E-21	0.0000	15.3374	-7.9206E-23
5486330.						
1048.	0.000	1.6074E-21	1.6431E-22	0.0000	15.3374	-2.3689E-23
5486330.						
1065.	0.000	1.0015E-21	-4.1737E-23	0.0000	15.3374	-6.9572E-25
5486330.						
1082.	0.000	1.9679E-22	-3.0436E-23	0.0000	15.3374	2.0331E-24
5486330.						
1099.	0.000	-2.7240E-23	-6.6645E-24	0.0000	15.3374	7.8007E-25
5486330.						
1115.	0.000	-2.8473E-23	5.8796E-25	0.0000	15.3374	0.0000
5486330.						
1132.	0.000	-7.3694E-24	8.4690E-25	0.0000	15.3374	0.0000
5486330.						
1149.	0.000	1.5194E-25	2.4057E-25	0.0000	15.3374	0.0000
5486330.						
1166.	0.000	7.6180E-25	0.0000	0.0000	15.3374	0.0000
5486330.						
1183.	0.000	2.5296E-25	0.0000	0.0000	15.3374	0.0000
5486330.						
1200.	0.000	0.0000	0.0000	0.0000	15.3374	0.0000
5486330.						
1217.	0.000	0.0000	0.0000	0.0000	15.3374	0.0000
7404154.						
1234.	0.000	0.0000	0.0000	0.0000	15.3374	0.0000
7404154.						
1251.	0.000	0.0000	0.0000	0.0000	15.3374	0.0000
7404154.						
1268.	0.000	0.0000	0.0000	0.0000	15.3374	0.0000
7404154.						
1284.	0.000	0.0000	0.0000	0.0000	15.3374	0.0000
7404154.						
1301.	0.000	0.0000	0.0000	0.0000	15.3374	0.0000
7404154.						
1318.	0.000	0.0000	0.0000	0.0000	15.3374	0.0000
7404154.						
1335.	0.000	0.0000	0.0000	0.0000	15.3374	0.0000
7404154.						
1352.	0.000	0.0000	0.0000	0.0000	15.3374	0.0000
7404154.						
1369.	0.000	0.0000	0.0000	0.0000	15.3374	0.0000
1.0911E+07						
1386.	0.000	0.0000	0.0000	0.0000	15.3374	0.0000
1.0911E+07						
1403.	0.000	0.0000	0.0000	0.0000	15.3374	0.0000
1.0911E+07						
1420.	0.000	0.0000	0.0000	0.0000	15.3374	0.0000

42 inch pipe - stratum 5 through 7.1po

1.0911E+07						
1436.	0.000	0.0000	0.0000	0.0000	15.3374	0.0000
1.0911E+07						
1453.	0.000	0.0000	0.0000	0.0000	15.3374	0.0000
1.0911E+07						
1470.	0.000	0.0000	0.0000	0.0000	15.3374	0.0000
1.0911E+07						
1487.	0.000	0.0000	0.0000	0.0000	15.3374	0.0000
1.0911E+07						
1504.	0.000	0.0000	0.0000	0.0000	15.3374	0.0000
1.0911E+07						
1521.	0.000	0.0000	0.0000	0.0000	15.3374	0.0000
1.0911E+07						
1538.	0.000	0.0000	0.0000	0.0000	15.3374	0.0000
1.0911E+07						
1555.	0.000	0.0000	0.0000	0.0000	15.3374	0.0000
1.0911E+07						
1572.	0.000	0.0000	0.0000	0.0000	15.3374	0.0000
1.0911E+07						
1589.	0.000	0.0000	0.0000	0.0000	15.3374	0.0000
1.0911E+07						
1605.	0.000	0.0000	0.0000	0.0000	15.3374	0.0000
1.0911E+07						
1622.	0.000	0.0000	0.0000	0.0000	15.3374	0.0000
1.0911E+07						
1639.	0.000	0.0000	0.0000	0.0000	15.3374	0.0000
1.0911E+07						
1656.	0.000	0.0000	0.0000	0.0000	15.3374	0.0000
1.0911E+07						
1673.	0.000	0.0000	0.0000	0.0000	15.3374	0.0000
1.0911E+07						
1690.	0.000	0.0000	0.0000	0.0000	15.3374	0.0000
5455523.						

Output Verification:

Computed forces and moments are within specified convergence limits.

Output Summary for Load Case No. 1:

Pile-head deflection = .02919017 in
 Computed slope at pile head = -.00053683
 Maximum bending moment = 34347.23764 lbs-in
 Maximum shear force = 1000.00000 lbs
 Depth of maximum bending moment = 50.70000000 in
 Depth of maximum shear force = 0.00000 in
 Number of iterations = 9
 Number of zero deflection points = 29

 Summary of Pile Response(s)

Definition of symbols for Pile-Head Loading Conditions:

Type 1 = Shear and Moment, y = pile-head displacement in
 Type 2 = Shear and Slope, M = Pile-head Moment lbs-in
 Type 3 = Shear and Rot. Stiffness, V = Pile-head Shear Force lbs
 Page 14

42 inch pipe - stratum 5 through 7.lpo

Type 4 = Deflection and Moment, S = Pile-head Slope, radians
 Type 5 = Deflection and Slope, R = Rot. Stiffness of Pile-head in-lbs/rad

Load Type	Pile-Head Condition 1	Pile-Head Condition 2	Axial Load lbs	Pile-Head Deflection in	Maximum Moment in-lbs	Maximum Shear lbs
1	V= 1000.000	M= 1000.000	1000.0000	.0291902	34347.2376	1000.0000

The analysis ended normally.

42 inch pipe - stratum 8 through 10.lpo

LPILE Plus for Windows, Version 5.0 (5.0.30)

Analysis of Individual Piles and Drilled Shafts
Subjected to Lateral Loading Using the p-y Method

(c) 1985-2007 by Ensoft, Inc.
All Rights Reserved

This program is licensed to:

DJI
Eustis

Path to file locations: U:\sys\WPDATA\Projects\20749\Piles\LPile\
Name of input data file: 42 inch pipe - stratum 8 through 10.lpd
Name of output file: 42 inch pipe - stratum 8 through 10.lpo
Name of plot output file: 42 inch pipe - stratum 8 through 10.lpp
Name of runtime file: 42 inch pipe - stratum 8 through 10.lpr

Time and Date of Analysis

Date: November 9, 2009 Time: 17:33:32

Problem Title

EE20749 - St. Mary Floodgate Structure at Franklin Drainage Canal

Program Options

Units Used in Computations - US Customary Units: Inches, Pounds

Basic Program Options:

Analysis Type 1:

- Computation of Lateral Pile Response Using User-specified Constant EI

Computation Options:

- Only internally-generated p-y curves used in analysis
- Analysis does not use p-y multipliers (individual pile or shaft action only)
- Analysis assumes no shear resistance at pile tip
- Analysis for fixed-length pile or shaft only
- No computation of foundation stiffness matrix elements
- Output pile response for full length of pile
- Analysis assumes no soil movements acting on pile
- Additional p-y curves computed at specified depths

Solution Control Parameters:

- Number of pile increments = 100
- Maximum number of iterations allowed = 100

42 inch pipe - stratum 8 through 10.lpo

- Deflection tolerance for convergence = 1.0000E-05 in
- Maximum allowable deflection = 1.0000E+02 in

Printing Options:

- Values of pile-head deflection, bending moment, shear force, and soil reaction are printed for full length of pile.
- Printing Increment (spacing of output points) = 1

Pile Structural Properties and Geometry

Pile Length = 1690.00 in
Depth of ground surface below top of pile = .00 in
Slope angle of ground surface = .00 deg.

Structural properties of pile defined using 2 points

Point	Depth X in	Pile Diameter in	Moment of Inertia in**4	Pile Area Sq.in	Modulus of Elasticity lbs/Sq.in
1	0.0000	42.00000000	152745.0000	65.2000	30000.00000
2	1690.0000	42.00000000	152745.0000	65.2000	30000.00000

Soil and Rock Layering Information

The soil profile is modelled using 10 layers

Layer 1 is silt with cohesion and friction
Distance from top of pile to top of layer = .000 in
Distance from top of pile to bottom of layer = 36.000 in
p-y subgrade modulus k for top of soil layer = 55.600 lbs/in**3
p-y subgrade modulus k for bottom of layer = 55.600 lbs/in**3

Layer 2 is soft clay, p-y criteria by Matlock, 1970
Distance from top of pile to top of layer = 36.000 in
Distance from top of pile to bottom of layer = 180.000 in

Layer 3 is silt with cohesion and friction
Distance from top of pile to top of layer = 180.000 in
Distance from top of pile to bottom of layer = 204.000 in
p-y subgrade modulus k for top of soil layer = 55.600 lbs/in**3
p-y subgrade modulus k for bottom of layer = 55.600 lbs/in**3

Layer 4 is soft clay, p-y criteria by Matlock, 1970
Distance from top of pile to top of layer = 204.000 in
Distance from top of pile to bottom of layer = 276.000 in

Layer 5 is soft clay, p-y criteria by Matlock, 1970
Distance from top of pile to top of layer = 276.000 in
Distance from top of pile to bottom of layer = 516.000 in

Layer 6 is stiff clay without free water
Distance from top of pile to top of layer = 516.000 in
Distance from top of pile to bottom of layer = 612.000 in

Layer 7 is stiff clay without free water
Distance from top of pile to top of layer = 612.000 in

42 inch pipe - stratum 8 through 10.lpo
 Distance from top of pile to bottom of layer = 828.000 in

Layer 8 is stiff clay without free water
 Distance from top of pile to top of layer = 828.000 in
 Distance from top of pile to bottom of layer = 1212.000 in

Layer 9 is stiff clay without free water
 Distance from top of pile to top of layer = 1212.000 in
 Distance from top of pile to bottom of layer = 1356.000 in

Layer 10 is stiff clay without free water
 Distance from top of pile to top of layer = 1356.000 in
 Distance from top of pile to bottom of layer = 1692.000 in

(Depth of lowest layer extends 2.00 in below pile tip)

 Effective Unit Weight of Soil vs. Depth

Distribution of effective unit weight of soil with depth
 is defined using 20 points

Point No.	Depth X in	Eff. Unit Weight lbs/in**3
1	.00	.03160
2	36.00	.03160
3	36.00	.03330
4	180.00	.03330
5	180.00	.03160
6	204.00	.03160
7	204.00	.03480
8	276.00	.03480
9	276.00	.03250
10	516.00	.03250
11	516.00	.03620
12	612.00	.03620
13	612.00	.03550
14	828.00	.03550
15	828.00	.03110
16	1212.00	.03110
17	1212.00	.03040
18	1356.00	.03040
19	1356.00	.03450
20	1692.00	.03450

 Shear Strength of Soils

Distribution of shear strength parameters with depth
 defined using 20 points

Point No.	Depth X in	Cohesion c lbs/in**2	Angle of Friction Deg.	E50 or k_rm	RQD %
1	.000	1.38890	15.00	.02000	.0
2	36.000	1.38890	15.00	.02000	.0

42 inch pipe - stratum 8 through 10.1po						
3	36.000	2.20140	.00	.02000	.0	
4	180.000	2.20140	.00	.02000	.0	
5	180.000	1.38890	15.00	.02000	.0	
6	204.000	1.38890	15.00	.02000	.0	
7	204.000	3.12500	.00	.02000	.0	
8	276.000	3.12500	.00	.02000	.0	
9	276.000	4.16670	.00	.01000	.0	
10	516.000	7.63890	.00	.00700	.0	
11	516.000	7.63890	.00	.00700	.0	
12	612.000	7.63890	.00	.00700	.0	
13	612.000	9.59030	.00	.00700	.0	
14	828.000	9.59030	.00	.00700	.0	
15	828.000	7.84720	.00	.00700	.0	
16	1212.000	7.84720	.00	.00700	.0	
17	1212.000	10.59030	.00	.00700	.0	
18	1356.000	10.59030	.00	.00700	.0	
19	1356.000	14.34720	.00	.00500	.0	
20	1692.000	14.34720	.00	.00500	.0	

Notes:

- (1) Cohesion = uniaxial compressive strength for rock materials.
- (2) Values of E50 are reported for clay strata.
- (3) Default values will be generated for E50 when input values are 0.
- (4) RQD and k_{rm} are reported only for weak rock strata.

Loading Type

Cyclic loading criteria was used for computation of p-y curves

Number of cycles of loading = 1000.

Pile-head Loading and Pile-head Fixity Conditions

Number of loads specified = 1

Load Case Number 1

Pile-head boundary conditions are Shear and Moment (BC Type 1)

Shear force at pile head = 1000.000 lbs
 Bending moment at pile head = 1000.000 in-lbs
 Axial load at pile head = 1000.000 lbs

Non-zero moment at pile head for this load case indicates the pile-head may rotate under the applied pile-head loading, but is not a free-head (zero moment) condition.

Output of p-y Curves at Specified Depths

42 inch pipe - stratum 8 through 10.lpo

p-y curves are generated and printed for verification at 8 depths.

Depth No.	Depth Below Pile Head in	Depth Below Ground Surface in
1	840.000	840.000
2	1020.000	1020.000
3	1200.000	1200.000
4	1224.000	1224.000
5	1284.000	1284.000
6	1344.000	1344.000
7	1524.000	1524.000
8	1690.000	1690.000

Depth of ground surface below top of pile = .00 in

p-y Curve Computed Using Cyclic Criteria for Stiff Clay without Free Water

Soil Layer Number = 8
 Depth below pile head = 840.000 in
 Depth below ground surface = 840.000 in
 Equivalent Depth = 659.348 in
 Diameter = 42.000 in
 Undrained cohesion, c = 7.84720 lbs/in**2
 Average Eff. Unit Weight = .03394 lbs/in**3
 Epsilon-50 = .00700
 Pct = 4515.769 lbs/in
 Pcd = 2966.242 lbs/in
 Pu = 2966.242 lbs/in
 y50 = .735 in
 p-multiplier = 1.00000
 y-multiplier = 1.00000
 Number of cycles of loading = 1000.

y, in	p, lbs/in
0.0000	0.0000
.0001176	128.9487
.0005880	192.8233
.0011760	229.3068
.0058800	342.8937
.0117600	407.7716
.0588000	609.7608
.1176000	725.1319
.2940000	911.8051
.5880000	1084.3251
.8820000	1200.0030
1.1760	1289.4871
2.9400	1621.4442
5.8800	1928.2330
11.7600	2293.0684
26.4600	2808.4238
41.1600	2966.2416

p-y Curve Computed Using Cyclic Criteria for Stiff Clay without Free Water

Soil Layer Number = 8
 Depth below pile head = 1020.000 in
 Depth below ground surface = 1020.000 in
 Page 5

42 inch pipe - stratum 8 through 10.1po

Equivalent Depth = 839.348 in
 Diameter = 42.000 in
 Undrained cohesion, c = 7.84720 lbs/in**2
 Average Eff. Unit Weight = .03344 lbs/in**3
 Epsilon-50 = .00700
 Pct = 5460.942 lbs/in
 Pcd = 2966.242 lbs/in
 Pu = 2966.242 lbs/in
 y50 = .735 in
 p-multiplier = 1.00000
 y-multiplier = 1.00000
 Number of cycles of loading = 1000.

y, in	p, lbs/in
0.0000	0.0000
.0001176	128.9487
.0005880	192.8233
.0011760	229.3068
.0058800	342.8937
.0117600	407.7716
.0588000	609.7608
.1176000	725.1319
.2940000	911.8051
.5880000	1084.3251
.8820000	1200.0030
1.1760	1289.4871
2.9400	1621.4442
5.8800	1928.2330
11.7600	2293.0684
26.4600	2808.4238
41.1600	2966.2416

p-y Curve Computed Using Cyclic Criteria for Stiff Clay without Free Water

Soil Layer Number = 8
 Depth below pile head = 1200.000 in
 Depth below ground surface = 1200.000 in
 Equivalent Depth = 1019.348 in
 Diameter = 42.000 in
 Undrained cohesion, c = 7.84720 lbs/in**2
 Average Eff. Unit Weight = .03309 lbs/in**3
 Epsilon-50 = .00700
 Pct = 6404.972 lbs/in
 Pcd = 2966.242 lbs/in
 Pu = 2966.242 lbs/in
 y50 = .735 in
 p-multiplier = 1.00000
 y-multiplier = 1.00000
 Number of cycles of loading = 1000.

y, in	p, lbs/in
0.0000	0.0000
.0001176	128.9487
.0005880	192.8233
.0011760	229.3068
.0058800	342.8937
.0117600	407.7716
.0588000	609.7608
.1176000	725.1319
.2940000	911.8051

	42 inch pipe - stratum 8 through 10.1po
.5880000	1084.3251
.8820000	1200.0030
1.1760	1289.4871
2.9400	1621.4442
5.8800	1928.2330
11.7600	2293.0684
26.4600	2808.4238
41.1600	2966.2416

p-y Curve Computed Using Cyclic Criteria for Stiff Clay without Free Water

Soil Layer Number	=	9
Depth below pile head	=	1224.000 in
Depth below ground surface	=	1224.000 in
Equivalent Depth	=	817.953 in
Diameter	=	42.000 in
Undrained cohesion, c	=	10.59030 lbs/in**2
Average Eff. Unit Weight	=	.03305 lbs/in**3
Epsilon-50	=	.00700
Pct	=	6800.796 lbs/in
Pcd	=	4003.133 lbs/in
Pu	=	4003.133 lbs/in
y50	=	.735 in
p-multiplier	=	1.00000
y-multiplier	=	1.00000
Number of cycles of loading	=	1000.

y, in	p, lbs/in
0.0000	0.0000
.0001176	174.0246
.0005880	260.2274
.0011760	309.4643
.0058800	462.7571
.0117600	550.3140
.0588000	822.9113
.1176000	978.6120
.2940000	1230.5395
.5880000	1463.3663
.8820000	1619.4811
1.1760	1740.2456
2.9400	2188.2430
5.8800	2602.2742
11.7600	3094.6430
26.4600	3790.1481
41.1600	4003.1334

p-y Curve Computed Using Cyclic Criteria for Stiff Clay without Free Water

Soil Layer Number	=	9
Depth below pile head	=	1284.000 in
Depth below ground surface	=	1284.000 in
Equivalent Depth	=	877.953 in
Diameter	=	42.000 in
Undrained cohesion, c	=	10.59030 lbs/in**2
Average Eff. Unit Weight	=	.03292 lbs/in**3
Epsilon-50	=	.00700
Pct	=	7197.221 lbs/in

42 inch pipe - stratum 8 through 10.7po

Pcd = 4003.133 lbs/in
 Pu = 4003.133 lbs/in
 y50 = .735 in
 p-multiplier = 1.00000
 y-multiplier = 1.00000
 Number of cycles of loading = 1000.

y, in	p, lbs/in
0.0000	0.0000
.0001176	174.0246
.0005880	260.2274
.0011760	309.4643
.0058800	462.7571
.0117600	550.3140
.0588000	822.9113
.1176000	978.6120
.2940000	1230.5395
.5880000	1463.3663
.8820000	1619.4811
1.1760	1740.2456
2.9400	2188.2430
5.8800	2602.2742
11.7600	3094.6430
26.4600	3790.1481
41.1600	4003.1334

p-y Curve Computed Using Cyclic Criteria for Stiff Clay without Free Water

Soil Layer Number = 9
 Depth below pile head = 1344.000 in
 Depth below ground surface = 1344.000 in
 Equivalent Depth = 937.953 in
 Diameter = 42.000 in
 Undrained cohesion, c = 10.59030 lbs/in**2
 Average Eff. Unit weight = .03281 lbs/in**3
 Epsilon-50 = .00700
 Pct = 7593.457 lbs/in
 Pcd = 4003.133 lbs/in
 Pu = 4003.133 lbs/in
 y50 = .735 in
 p-multiplier = 1.00000
 y-multiplier = 1.00000
 Number of cycles of loading = 1000.

y, in	p, lbs/in
0.0000	0.0000
.0001176	174.0246
.0005880	260.2274
.0011760	309.4643
.0058800	462.7571
.0117600	550.3140
.0588000	822.9113
.1176000	978.6120
.2940000	1230.5395
.5880000	1463.3663
.8820000	1619.4811
1.1760	1740.2456
2.9400	2188.2430
5.8800	2602.2742
11.7600	3094.6430

26.4600 42 inch pipe - stratum 8 through 10.lpo
 41.1600 3790.1481
 4003.1334

p-y Curve Computed Using Cyclic Criteria for Stiff Clay without Free Water

Soil Layer Number = 10
 Depth below pile head = 1524.000 in
 Depth below ground surface = 1524.000 in
 Equivalent Depth = 908.347 in
 Diameter = 42.000 in
 Undrained cohesion, c = 14.34720 lbs/in**2
 Average Eff. Unit Weight = .03298 lbs/in**3
 Epsilon-50 = .00500
 Pct = 9581.929 lbs/in
 Pcd = 5423.242 lbs/in
 Pu = 5423.242 lbs/in
 y50 = .525 in
 p-multiplier = 1.00000
 y-multiplier = 1.00000
 Number of cycles of loading = 1000.

y, in	p, lbs/in
0.0000	0.0000
8.4000E-05	235.7596
.0004200	352.5429
.0008400	419.2465
.0042000	626.9197
.0084000	745.5374
.0420000	1114.8385
.0840000	1325.7738
.2100000	1667.0723
.4200000	1982.4943
.6300000	2193.9906
.8400000	2357.5963
2.1000	2964.5204
4.2000	3525.4288
8.4000	4192.4650
18.9000	5134.7000
29.4000	5423.2416

p-y Curve Computed Using Cyclic Criteria for Stiff Clay without Free Water

Soil Layer Number = 10
 Depth below pile head = 1690.000 in
 Depth below ground surface = 1690.000 in
 Equivalent Depth = 1074.347 in
 Diameter = 42.000 in
 Undrained cohesion, c = 14.34720 lbs/in**2
 Average Eff. Unit Weight = .03313 lbs/in**3
 Epsilon-50 = .00500
 Pct = 11009.411 lbs/in
 Pcd = 5423.242 lbs/in
 Pu = 5423.242 lbs/in
 y50 = .525 in
 p-multiplier = 1.00000
 y-multiplier = 1.00000
 Number of cycles of loading = 1000.

42 inch pipe - stratum 8 through 10.lpo

y, in	p, lbs/in
0.0000	0.0000
8.4000E-05	235.7596
.0004200	352.5429
.0008400	419.2465
.0042000	626.9197
.0084000	745.5374
.0420000	1114.8385
.0840000	1325.7738
.2100000	1667.0723
.4200000	1982.4943
.6300000	2193.9906
.8400000	2357.5963
2.1000	2964.5204
4.2000	3525.4288
8.4000	4192.4650
18.9000	5134.7000
29.4000	5423.2416

 Computed Values of Load Distribution and Deflection
 for Lateral Loading for Load Case Number 1

Pile-head boundary conditions are Shear and Moment (BC Type 1)
 Specified shear force at pile head = 1000.000 lbs
 Specified moment at pile head = 1000.000 in-lbs
 Specified axial load at pile head = 1000.000 lbs

Non-zero moment for this load case indicates the pile-head may rotate under the applied pile-head loading, but is not a free-head (zero moment) condition.

Depth Es*h X F/L in lbs/in	Deflect. y in	Moment M lbs-in	Shear V lbs	Slope S Rad.	Total Stress lbs/in**2	Soil Res. p lbs/in
0.000	.029190	1000.0000	1000.0000	-.0005368	15.4749	0.0000
0.0000						
16.900	.020149	17909.0413	840.0185	-.0005020	17.7996	-18.9327
15879.9160						
33.800	.012224	29409.5904	485.9225	-.0004147	19.3808	-22.9721
31759.8320						
50.700	.006132	34347.2376	49.2548	-.0002971	20.0596	-28.7045
79111.5323						
67.600	.002181	31084.4471	-383.2895	-.0001765	19.6110	-22.4842
174243.						
84.500	.000167	21398.0182	-603.3664	-7.9697E-05	18.2793	-3.5604
360217.						
101.400	-.000513	10693.3574	-533.0303	-2.0519E-05	16.8076	11.8842
391524.						
118.300	-.000527	3382.2870	-321.2979	5.4369E-06	15.8024	13.1729
422830.						
135.200	-.000329	-166.6949	-135.2332	1.1367E-05	15.3603	8.8466

42 inch pipe - stratum 8 through 10.lpo

454137.						
152.100	-.000142	-1188.9800	-25.9363	8.8666E-06	15.5009	4.0879
485443.						
169.000	-2.95E-05	-1043.6430	16.2344	4.7496E-06	15.4809	.9027072
516750.						
185.900	1.82E-05	-640.4188	22.4920	1.6441E-06	15.4255	-.1621576
150401.						
202.800	2.60E-05	-283.4685	18.9561	-5.9566E-08	15.3764	-.2562932
166280.						
219.700	1.62E-05	.2996135	10.5376	-5.8174E-07	15.3375	-.7399834
771588.						
236.600	6.39E-06	72.7210	1.7002	-4.4709E-07	15.3474	-.3058611
809468.						
253.500	1.10E-06	57.7809	-1.3488	-2.0644E-07	15.3454	-.0549664
847348.						
270.400	-5.92E-07	27.1383	-1.5542	-4.9842E-08	15.3412	.0306589
875533.						
287.300	-5.88E-07	5.2504	-.8619495	9.8836E-09	15.3381	.0512651
1472469.						
304.200	-2.58E-07	-1.9960	-.2220886	1.5885E-08	15.3377	.0244581
1603782.						
321.100	-5.15E-08	-2.2567	.0292223	8.0428E-09	15.3377	.0052828
1734362.						
338.000	1.41E-08	-1.0085	.0609014	2.0216E-09	15.3376	-.0015338
1836160.						
354.900	1.69E-08	-.1983227	.0315949	-2.0383E-10	15.3375	-.0019344
1939740.						
371.800	7.23E-09	.0594012	.0078580	-4.6001E-10	15.3374	-.0008747
2045190.						
388.700	1.31E-09	.0672947	-.0009379	-2.2638E-10	15.3374	-.0001662
2152606.						
405.600	-4.23E-10	.0277065	-.0018636	-5.1190E-11	15.3374	5.6683E-05
2262088.						
422.500	-4.25E-10	.0043058	-.0008801	7.8417E-12	15.3374	5.9715E-05
2373749.						
439.400	-1.58E-10	-.0020401	-.0001784	1.2020E-11	15.3374	2.3321E-05
2487708.						
456.300	-1.89E-11	-.0017250	4.3224E-05	5.0767E-12	15.3374	2.9083E-06
2604096.						
473.200	1.32E-11	-.0005793	4.9877E-05	8.2753E-13	15.3374	-2.1210E-06
2723054.						
490.100	9.10E-12	-3.9225E-05	1.9016E-05	-3.1298E-13	15.3374	-1.5312E-06
2844737.						
507.000	2.58E-12	6.3495E-05	2.2403E-06	-2.6822E-13	15.3374	-4.5413E-07
2969314.						
523.900	3.04E-14	3.6506E-05	-1.6721E-06	-8.3820E-14	15.3374	-8.8777E-09
4927737.						
540.800	-2.48E-13	6.9801E-06	-1.1145E-06	-3.6298E-15	15.3374	7.4868E-08
5093115.						
557.700	-9.22E-14	-1.1634E-06	-2.3932E-07	7.0964E-15	15.3374	2.8702E-08
5258586.						
574.600	-8.57E-15	-1.1093E-06	2.6092E-08	2.9055E-15	15.3374	2.7083E-09
5340698.						
591.500	5.96E-15	-2.8158E-07	3.3055E-08	3.4066E-16	15.3374	-1.8842E-09
5340698.						
608.400	2.94E-15	7.9708E-09	9.2711E-09	-1.6389E-16	15.3374	-9.3044E-10
5340698.						
625.300	4.23E-16	3.1784E-08	4.2017E-11	-9.0586E-17	15.3374	-1.6176E-10
6465493.						
642.200	-1.18E-16	9.3940E-09	-9.3343E-10	-1.4652E-17	15.3374	4.6326E-11
6660935.						
659.100	-7.24E-17	2.3457E-10	-2.9926E-10	3.1036E-18	15.3374	2.8724E-11
6705010.						

42 inch pipe - stratum 8 through 10.lpo

676.000	-1.26E-17	-7.2107E-10	-1.4177E-11	2.2065E-18	15.3374	5.0138E-12
6705010.						
692.900	2.18E-18	-2.4467E-10	2.0880E-11	4.2561E-19	15.3374	-8.6507E-13
6705010.						
709.800	1.75E-18	-1.5328E-11	7.7093E-12	-5.3835E-20	15.3374	-6.9363E-13
6705010.						
726.700	3.61E-19	1.5906E-11	6.3853E-13	-5.2770E-20	15.3374	-1.4315E-13
6705010.						
743.600	-3.53E-20	6.2556E-12	-4.5268E-13	-1.1903E-20	15.3374	1.4009E-14
6705010.						
760.500	-4.15E-20	6.0580E-13	-1.9514E-13	7.4996E-22	15.3374	1.6470E-14
6705010.						
777.400	-9.96E-21	-3.3996E-13	-2.2569E-14	1.2402E-21	15.3374	3.9516E-15
6705010.						
794.300	4.05E-22	-1.5708E-13	9.4657E-15	3.2363E-22	15.3374	-1.6049E-16
6705010.						
811.200	9.79E-22	-2.0027E-14	4.8289E-15	-2.9621E-24	15.3374	-3.8825E-16
6705010.						
828.100	3.04E-22	6.1370E-15	7.1315E-16	-2.8576E-23	15.3374	-9.8817E-17
5486330.						
845.000	1.27E-23	4.0780E-15	-1.5671E-16	-9.7396E-24	15.3374	-4.1252E-18
5486330.						
861.900	-2.48E-23	8.4058E-16	-1.2353E-16	-6.6951E-25	15.3374	8.0521E-18
5486330.						
878.800	-9.92E-24	-9.7150E-17	-2.8267E-17	7.0140E-25	15.3374	3.2211E-18
5486330.						
895.700	-1.10E-24	-1.1488E-16	1.9586E-18	3.1040E-25	15.3374	3.5590E-19
5486330.						
912.600	5.69E-25	-3.0961E-17	3.4044E-18	0.0000	15.3374	-1.8480E-19
5486330.						
929.500	3.05E-25	1.8288E-19	1.0059E-18	0.0000	15.3374	-9.9038E-20
5486330.						
946.400	0.000	3.0404E-18	2.5614E-20	0.0000	15.3374	-1.6977E-20
5486330.						
963.300	0.000	1.0490E-18	-8.7715E-20	0.0000	15.3374	3.5651E-21
5486330.						
980.200	0.000	7.5693E-20	-3.3232E-20	0.0000	15.3374	2.8826E-21
5486330.						
997.100	0.000	-7.4283E-20	-3.2254E-21	0.0000	15.3374	6.6847E-22
5486330.						
1014.	0.000	-3.3334E-20	2.0631E-21	0.0000	15.3374	-4.2609E-23
5486330.						
1031.	0.000	-4.5525E-21	1.0338E-21	0.0000	15.3374	-7.9206E-23
5486330.						
1048.	0.000	1.6074E-21	1.6431E-22	0.0000	15.3374	-2.3689E-23
5486330.						
1065.	0.000	1.0015E-21	-4.1737E-23	0.0000	15.3374	-6.9572E-25
5486330.						
1082.	0.000	1.9679E-22	-3.0436E-23	0.0000	15.3374	2.0331E-24
5486330.						
1099.	0.000	-2.7240E-23	-6.6645E-24	0.0000	15.3374	7.8007E-25
5486330.						
1115.	0.000	-2.8473E-23	5.8796E-25	0.0000	15.3374	0.0000
5486330.						
1132.	0.000	-7.3694E-24	8.4690E-25	0.0000	15.3374	0.0000
5486330.						
1149.	0.000	1.5194E-25	2.4057E-25	0.0000	15.3374	0.0000
5486330.						
1166.	0.000	7.6180E-25	0.0000	0.0000	15.3374	0.0000
5486330.						
1183.	0.000	2.5296E-25	0.0000	0.0000	15.3374	0.0000
5486330.						
1200.	0.000	0.0000	0.0000	0.0000	15.3374	0.0000

42 inch pipe - stratum 8 through 10.lpo

5486330.						
1217.	0.000	0.0000	0.0000	0.0000	15.3374	0.0000
7404154.						
1234.	0.000	0.0000	0.0000	0.0000	15.3374	0.0000
7404154.						
1251.	0.000	0.0000	0.0000	0.0000	15.3374	0.0000
7404154.						
1268.	0.000	0.0000	0.0000	0.0000	15.3374	0.0000
7404154.						
1284.	0.000	0.0000	0.0000	0.0000	15.3374	0.0000
7404154.						
1301.	0.000	0.0000	0.0000	0.0000	15.3374	0.0000
7404154.						
1318.	0.000	0.0000	0.0000	0.0000	15.3374	0.0000
7404154.						
1335.	0.000	0.0000	0.0000	0.0000	15.3374	0.0000
7404154.						
1352.	0.000	0.0000	0.0000	0.0000	15.3374	0.0000
7404154.						
1369.	0.000	0.0000	0.0000	0.0000	15.3374	0.0000
1.0911E+07						
1386.	0.000	0.0000	0.0000	0.0000	15.3374	0.0000
1.0911E+07						
1403.	0.000	0.0000	0.0000	0.0000	15.3374	0.0000
1.0911E+07						
1420.	0.000	0.0000	0.0000	0.0000	15.3374	0.0000
1.0911E+07						
1436.	0.000	0.0000	0.0000	0.0000	15.3374	0.0000
1.0911E+07						
1453.	0.000	0.0000	0.0000	0.0000	15.3374	0.0000
1.0911E+07						
1470.	0.000	0.0000	0.0000	0.0000	15.3374	0.0000
1.0911E+07						
1487.	0.000	0.0000	0.0000	0.0000	15.3374	0.0000
1.0911E+07						
1504.	0.000	0.0000	0.0000	0.0000	15.3374	0.0000
1.0911E+07						
1521.	0.000	0.0000	0.0000	0.0000	15.3374	0.0000
1.0911E+07						
1538.	0.000	0.0000	0.0000	0.0000	15.3374	0.0000
1.0911E+07						
1555.	0.000	0.0000	0.0000	0.0000	15.3374	0.0000
1.0911E+07						
1572.	0.000	0.0000	0.0000	0.0000	15.3374	0.0000
1.0911E+07						
1589.	0.000	0.0000	0.0000	0.0000	15.3374	0.0000
1.0911E+07						
1605.	0.000	0.0000	0.0000	0.0000	15.3374	0.0000
1.0911E+07						
1622.	0.000	0.0000	0.0000	0.0000	15.3374	0.0000
1.0911E+07						
1639.	0.000	0.0000	0.0000	0.0000	15.3374	0.0000
1.0911E+07						
1656.	0.000	0.0000	0.0000	0.0000	15.3374	0.0000
1.0911E+07						
1673.	0.000	0.0000	0.0000	0.0000	15.3374	0.0000
1.0911E+07						
1690.	0.000	0.0000	0.0000	0.0000	15.3374	0.0000
5455523.						

Output Verification:

Computed forces and moments are within specified convergence limits.

42 inch pipe - stratum 8 through 10.lpo

Output Summary for Load Case No. 1:

Pile-head deflection = .02919017 in
 Computed slope at pile head = -.00053683
 Maximum bending moment = 34347.23764 lbs-in
 Maximum shear force = 1000.00000 lbs
 Depth of maximum bending moment = 50.70000000 in
 Depth of maximum shear force = 0.00000 in
 Number of iterations = 9
 Number of zero deflection points = 29

 Summary of Pile Response(s)

Definition of Symbols for Pile-Head Loading Conditions:

Type 1 = Shear and Moment, y = pile-head displacement in
 Type 2 = Shear and Slope, M = Pile-head Moment lbs-in
 Type 3 = Shear and Rot. Stiffness, V = Pile-head Shear Force lbs
 Type 4 = Deflection and Moment, S = Pile-head Slope, radians
 Type 5 = Deflection and Slope, R = Rot. Stiffness of Pile-head in-lbs/rad

Load Type	Pile-Head Condition 1	Pile-Head Condition 2	Axial Load lbs	Pile-Head Deflection in	Maximum Moment in-lbs	Maximum Shear lbs
1	V= 1000.000	M= 1000.000	1000.0000	.0291902	34347.2376	1000.0000

The analysis ended normally.

48 inch pipe - stratum 1 through 3.lpo

LPILE Plus for Windows, Version 5.0 (5.0.30)

Analysis of Individual Piles and Drilled Shafts
Subjected to Lateral Loading Using the p-y Method

(c) 1985-2007 by Ensoft, Inc.
All Rights Reserved

This program is licensed to:

DJI
Eustis

Path to file locations: U:\sys\WPDATA\Projects\20749\Piles\LPile\
Name of input data file: 48 inch pipe - stratum 1 through 3.lpd
Name of output file: 48 inch pipe - stratum 1 through 3.lpo
Name of plot output file: 48 inch pipe - stratum 1 through 3.lpp
Name of runtime file: 48 inch pipe - stratum 1 through 3.lpr

Time and Date of Analysis

Date: November 9, 2009 Time: 16:40:58

Problem Title

EE20749 - St. Mary Floodgate Structure at Franklin Drainage Canal

Program Options

Units Used in Computations - US Customary Units: Inches, Pounds

Basic Program Options:

Analysis Type 1:

- Computation of Lateral Pile Response Using User-specified Constant EI

Computation Options:

- Only internally-generated p-y curves used in analysis
- Analysis does not use p-y multipliers (individual pile or shaft action only)
- Analysis assumes no shear resistance at pile tip
- Analysis for fixed-length pile or shaft only
- No computation of foundation stiffness matrix elements
- Output pile response for full length of pile
- Analysis assumes no soil movements acting on pile
- Additional p-y curves computed at specified depths

Solution Control Parameters:

- Number of pile increments = 100
- Maximum number of iterations allowed = 100

48 inch pipe - stratum 1 through 3.lpo

- Deflection tolerance for convergence = 1.0000E-05 in
- Maximum allowable deflection = 1.0000E+02 in

Printing Options:

- Values of pile-head deflection, bending moment, shear force, and soil reaction are printed for full length of pile.
- Printing Increment (spacing of output points) = 1

Pile Structural Properties and Geometry

Pile Length = 1690.00 in
Depth of ground surface below top of pile = .00 in
Slope angle of ground surface = .00 deg.

Structural properties of pile defined using 2 points

Point	Depth X in	Pile Diameter in	Moment of Inertia in**4	Pile Area Sq.in	Modulus of Elasticity lbs/Sq.in
1	0.0000	48.00000000	260576.3000	74.6000	30000.00000
2	1690.0000	48.00000000	260576.3000	74.6000	30000.00000

Soil and Rock Layering Information

The soil profile is modelled using 10 layers

Layer 1 is silt with cohesion and friction
Distance from top of pile to top of layer = .000 in
Distance from top of pile to bottom of layer = 36.000 in
p-y subgrade modulus k for top of soil layer = 55.600 lbs/in**3
p-y subgrade modulus k for bottom of layer = 55.600 lbs/in**3

Layer 2 is soft clay, p-y criteria by Matlock, 1970
Distance from top of pile to top of layer = 36.000 in
Distance from top of pile to bottom of layer = 180.000 in

Layer 3 is silt with cohesion and friction
Distance from top of pile to top of layer = 180.000 in
Distance from top of pile to bottom of layer = 204.000 in
p-y subgrade modulus k for top of soil layer = 55.600 lbs/in**3
p-y subgrade modulus k for bottom of layer = 55.600 lbs/in**3

Layer 4 is soft clay, p-y criteria by Matlock, 1970
Distance from top of pile to top of layer = 204.000 in
Distance from top of pile to bottom of layer = 276.000 in

Layer 5 is soft clay, p-y criteria by Matlock, 1970
Distance from top of pile to top of layer = 276.000 in
Distance from top of pile to bottom of layer = 516.000 in

Layer 6 is stiff clay without free water
Distance from top of pile to top of layer = 516.000 in
Distance from top of pile to bottom of layer = 612.000 in

Layer 7 is stiff clay without free water
Distance from top of pile to top of layer = 612.000 in

48 inch pipe - stratum 1 through 3.1po
 Distance from top of pile to bottom of layer = 828.000 in

Layer 8 is stiff clay without free water
 Distance from top of pile to top of layer = 828.000 in
 Distance from top of pile to bottom of layer = 1212.000 in

Layer 9 is stiff clay without free water
 Distance from top of pile to top of layer = 1212.000 in
 Distance from top of pile to bottom of layer = 1356.000 in

Layer 10 is stiff clay without free water
 Distance from top of pile to top of layer = 1356.000 in
 Distance from top of pile to bottom of layer = 1692.000 in

(Depth of lowest layer extends 2.00 in below pile tip)

 Effective Unit Weight of Soil vs. Depth

Distribution of effective unit weight of soil with depth
 is defined using 20 points

Point No.	Depth X in	Eff. Unit Weight lbs/in**3
1	.00	.03160
2	36.00	.03160
3	36.00	.03330
4	180.00	.03330
5	180.00	.03160
6	204.00	.03160
7	204.00	.03480
8	276.00	.03480
9	276.00	.03250
10	516.00	.03250
11	516.00	.03620
12	612.00	.03620
13	612.00	.03550
14	828.00	.03550
15	828.00	.03110
16	1212.00	.03110
17	1212.00	.03040
18	1356.00	.03040
19	1356.00	.03450
20	1692.00	.03450

 Shear Strength of Soils

Distribution of shear strength parameters with depth
 defined using 20 points

Point No.	Depth X in	Cohesion c lbs/in**2	Angle of Friction Deg.	E50 or k_rm	RQD %
1	.000	1.38890	15.00	.02000	.0
2	36.000	1.38890	15.00	.02000	.0

48 inch pipe - stratum 1 through 3.1po						
3	36.000	2.20140	.00	.02000	.0	
4	180.000	2.20140	.00	.02000	.0	
5	180.000	1.38890	15.00	.02000	.0	
6	204.000	1.38890	15.00	.02000	.0	
7	204.000	3.12500	.00	.02000	.0	
8	276.000	3.12500	.00	.02000	.0	
9	276.000	4.16670	.00	.01000	.0	
10	516.000	7.63890	.00	.00700	.0	
11	516.000	7.63890	.00	.00700	.0	
12	612.000	7.63890	.00	.00700	.0	
13	612.000	9.59030	.00	.00700	.0	
14	828.000	9.59030	.00	.00700	.0	
15	828.000	7.84720	.00	.00700	.0	
16	1212.000	7.84720	.00	.00700	.0	
17	1212.000	10.59030	.00	.00700	.0	
18	1356.000	10.59030	.00	.00700	.0	
19	1356.000	14.34720	.00	.00500	.0	
20	1692.000	14.34720	.00	.00500	.0	

Notes:

- (1) Cohesion = uniaxial compressive strength for rock materials.
- (2) Values of E50 are reported for clay strata.
- (3) Default values will be generated for E50 when input values are 0.
- (4) RQD and k_{rm} are reported only for weak rock strata.

Loading Type

Cyclic loading criteria was used for computation of p-y curves

Number of cycles of loading = 1000.

Pile-head Loading and Pile-head Fixity Conditions

Number of loads specified = 1

Load Case Number 1

Pile-head boundary conditions are Shear and Moment (BC Type 1)

Shear force at pile head = .000 lbs
Bending moment at pile head = .000 in-lbs
Axial load at pile head = .000 lbs

(Zero moment at pile head for this load indicates a free-head condition)

Output of p-y Curves at Specified Depths

48 inch pipe - stratum 1 through 3.1po
 p-y curves are generated and printed for verification at 25 depths.

Depth No.	Depth Below Pile Head in	Depth Below Ground Surface in
1	18.000	18.000
2	48.000	48.000
3	108.000	108.000
4	168.000	168.000
5	192.000	192.000
6	216.000	216.000
7	240.000	240.000
8	264.000	264.000
9	288.000	288.000
10	396.000	396.000
11	504.000	504.000
12	528.000	528.000
13	564.000	564.000
14	600.000	600.000
15	624.000	624.000
16	720.000	720.000
17	816.000	816.000
18	840.000	840.000
19	1020.000	1020.000
20	1200.000	1200.000
21	1224.000	1224.000
22	1284.000	1284.000
23	1344.000	1344.000
24	1524.000	1524.000
25	1690.000	1690.000

Depth of ground surface below top of pile = .00 in

Eq. 3.65	34.8546
Eq. 3.66	126.1230
Eq. 3.67	3.5970
Eq. 3.67	239.8041
Eq. 3.69	270.6504
Eq. 3.75	-3.6437
Eq. 3.76	387.5143
Eq. 3.77	.4750

p-y Curve Computed Using the Cyclic Criteria for Cemented silt

Soil Layer Number	=	1
Depth below pile head	=	18.000 in
Depth below ground surface	=	18.000in
Equivalent Depth	=	18.000in
Pile Diameter	=	48.000in
Cohesion, c	=	1.389lbs/in**2
Angle of Friction	=	15.000 deg.
Avg. Eff. Unit Weight	=	.03160lbs/in**3
k (internal default)	=	55.600lbs/in**3
E50 (internal default)	=	.02000
A parameter	=	.88500
B parameter	=	.67250
Pu	=	239.804lbs/in
Pc	=	34.855lbs/in
Number of Cycles of Loading	=	1000.
p-multiplier	=	1.00000
y-multiplier	=	1.00000
Pu,c	=	239.804lbs/in
Pc,phi	=	34.855lbs/in

48 inch pipe - stratum 1 through 3.lpo

y, in	p, lbs/in
0.0000	0.0000
.0666667	66.7200
.1333333	133.4400
.2000000	200.1600
.2666667	266.8800
.3333333	333.6000
.4000000	400.3200
.4666667	467.0400
.5333333	460.4823
.6000000	445.8349
.6666667	433.1277
.7333333	421.9449
.8000000	411.9881
1.8000	270.6504
49.8000	270.6504
97.8000	270.6504
145.8000	270.6504

p-y Curve Computed Using the soft Clay Criteria for Cyclic Loading Conditions

Soil Layer Number	=	2
Depth below pile head	=	48.000 in
Depth below ground surface	=	48.000 in
Equivalent Depth	=	39.909 in
Pile Diameter	=	48.000 in
Cohesion, c	=	2.201 lbs/in**2
Avg Eff Unit Weight	=	.03203 lbs/in**3
E50 parameter	=	.02000
Default J parameter	=	.500
Y50	=	2.40000 in
p-multiplier	=	1.00000
y-multiplier	=	1.00000
Number of cycles of loading	=	1000.
Xr	=	240.344 in

y, in	p, lbs/in
0.0000	0.0000
.0192000	44.3621
.6000000	139.7318
1.2000	176.0510
1.8000	201.5281
2.4000	221.8104
3.0000	238.9380
3.6000	253.9095
4.2000	267.2973
4.8000	279.4636
5.4000	290.6539
6.0000	301.0430
6.6000	310.7607
7.2000	319.9060
19.2000	208.4195
36.0000	53.0370
48.0000	53.0370

48 inch pipe - stratum 1 through 3.1po

p-y Curve Computed Using the Soft Clay Criteria for Cyclic Loading Conditions

```

Soil Layer Number      =          2
Depth below pile head  =        108.000 in
Depth below ground surface =      108.000 in
Equivalent Depth       =        99.909 in
Pile Diameter          =        48.000 in
Cohesion, c           =        2.201 lbs/in**2
Avg Eff Unit Weight    =        .03273 lbs/in**3
E50 parameter         =        .02000
Default J parameter    =          .500
Y50                   =        2.40000 in
p-multiplier          =        1.00000
y-multiplier          =        1.00000
Number of cycles of loading =      1000.
Xr                    =        237.286 in
    
```

y, in	p, lbs/in
0.0000	0.0000
.0192000	60.5567
.6000000	190.7416
1.2000	240.3193
1.8000	275.0970
2.4000	302.7834
3.0000	326.1635
3.6000	346.6005
4.2000	364.8755
4.8000	381.4832
5.4000	396.7585
6.0000	410.9403
6.6000	424.2055
7.2000	436.6892
19.2000	330.8300
36.0000	183.5806
48.0000	183.5806

p-y Curve Computed Using the Soft Clay Criteria for Cyclic Loading Conditions

```

Soil Layer Number      =          2
Depth below pile head  =        168.000 in
Depth below ground surface =      168.000 in
Equivalent Depth       =        159.909 in
Pile Diameter          =        48.000 in
Cohesion, c           =        2.201 lbs/in**2
Avg Eff Unit Weight    =        .03294 lbs/in**3
E50 parameter         =        .02000
Default J parameter    =          .500
Y50                   =        2.40000 in
p-multiplier          =        1.00000
y-multiplier          =        1.00000
Number of cycles of loading =      1000.
Xr                    =        236.426 in
    
```

y, in	p, lbs/in
0.0000	0.0000
.0192000	76.7513
.6000000	241.7514
1.2000	304.5877
1.8000	348.6658
2.4000	383.7564

48 inch pipe - stratum 1 through 3.1po

3.0000	413.3891
3.6000	439.2914
4.2000	462.4538
4.8000	483.5028
5.4000	502.8631
6.0000	520.8376
6.6000	537.6503
7.2000	553.4725
19.2000	478.0896
36.0000	373.7620
48.0000	373.7620

Eq.	3.65	685.8429
Eq.	3.66	1399.5928
Eq.	3.67	8.6156
Eq.	3.67	574.3796
Eq.	3.69	1207.2145
Eq.	3.75	-3.4590
Eq.	3.76	1772.2370
Eq.	3.77	.2796

p-y Curve Computed Using the Cyclic Criteria for Cemented Silt

Soil Layer Number	=	3
Depth below pile head	=	192.000 in
Depth below ground surface	=	192.000in
Equivalent Depth	=	164.746in
Pile Diameter	=	48.000in
Cohesion, c	=	1.389lbs/in**2
Angle of Friction	=	15.000 deg.
Avg. Eff. Unit Weight	=	.03288lbs/in**3
k (internal default)	=	55.600lbs/in**3
E50 (internal default)	=	.02000
A parameter	=	.92271
B parameter	=	.63517
Pu	=	574.380lbs/in
Pc	=	685.843lbs/in
Number of Cycles of Loading	=	1000.
p-multiplier	=	1.00000
y-multiplier	=	1.00000
Pu,c	=	574.380lbs/in
Pc,phi	=	685.843lbs/in

y, in	p, lbs/in
0.0000	0.0000
.0666667	610.6600
.1333333	1221.3200
.2000000	1831.9800
.2666667	2442.6399
.3333333	2434.7675
.4000000	2309.7565
.4666667	2209.0823
.5333333	2125.4282
.6000000	2054.2734
.6666667	1992.6442
.7333333	1938.4881
.8000000	1890.3336
1.8000	1207.2145
49.8000	1207.2145

97.8000 48 inch pipe - stratum 1 through 3.1po
 145.8000 1207.2145
 1207.2145

p-y Curve Computed Using the Soft Clay Criteria for Cyclic Loading Conditions

Soil Layer Number = 4
 Depth below pile head = 216.000 in
 Depth below ground surface = 216.000 in
 Equivalent Depth = 311.079 in
 Pile Diameter = 48.000 in
 Cohesion, c = 3.125 lbs/in**2
 Avg Eff Unit Weight = .03291 lbs/in**3
 E50 parameter = .02000
 Default J parameter = .500
 Y50 = 2.40000 in
 p-multiplier = 1.00000
 y-multiplier = 1.00000
 Number of cycles of loading = 1000.
 Xr = 286.420 in

y, in	p, lbs/in
0.0000	0.0000
.0192000	112.8722
.6000000	355.5253
1.2000	447.9338
1.8000	512.7562
2.4000	564.3612
3.0000	607.9397
3.6000	646.0323
4.2000	680.0954
4.8000	711.0506
5.4000	739.5224
6.0000	765.9560
6.6000	790.6811
7.2000	813.9497
19.2000	812.6802
36.0000	812.6802
48.0000	812.6802

p-y Curve Computed Using the Soft Clay Criteria for Cyclic Loading Conditions

Soil Layer Number = 4
 Depth below pile head = 240.000 in
 Depth below ground surface = 240.000 in
 Equivalent Depth = 335.079 in
 Pile Diameter = 48.000 in
 Cohesion, c = 3.125 lbs/in**2
 Avg Eff Unit Weight = .03310 lbs/in**3
 E50 parameter = .02000
 Default J parameter = .500
 Y50 = 2.40000 in
 p-multiplier = 1.00000
 y-multiplier = 1.00000
 Number of cycles of loading = 1000.
 Xr = 285.596 in

y, in p, lbs/in

48 inch pipe - stratum 1 through 3.1po

-----	-----
0.0000	0.0000
.0192000	120.6312
.6000000	379.9645
1.2000	478.7252
1.8000	548.0036
2.4000	603.1560
3.0000	649.7301
3.6000	690.4413
4.2000	726.8459
4.8000	759.9289
5.4000	790.3580
6.0000	818.6086
6.6000	845.0334
7.2000	869.9015
19.2000	868.5447
36.0000	868.5447
48.0000	868.5447

p-y Curve Computed Using the Soft Clay Criteria for Cyclic Loading Conditions

Soil Layer Number	=	4
Depth below pile head	=	264.000 in
Depth below ground surface	=	264.000 in
Equivalent Depth	=	359.079 in
Pile Diameter	=	48.000 in
Cohesion, c	=	3.125 lbs/in**2
Avg Eff Unit Weight	=	.03325 lbs/in**3
E50 parameter	=	.02000
Default J parameter	=	.500
Y50	=	2.40000 in
p-multiplier	=	1.00000
y-multiplier	=	1.00000
Number of cycles of loading	=	1000.
Xr	=	284.926 in

-----	-----
y, in	p, lbs/in
0.0000	0.0000
.0192000	128.3902
.6000000	404.4037
1.2000	509.5167
1.8000	583.2510
2.4000	641.9508
3.0000	691.5205
3.6000	734.8502
4.2000	773.5964
4.8000	808.8073
5.4000	841.1935
6.0000	871.2613
6.6000	899.3857
7.2000	925.8533
19.2000	924.4092
36.0000	924.4092
48.0000	924.4092

p-y Curve Computed Using the Soft Clay Criteria for Cyclic Loading Conditions

48 inch pipe - stratum 1 through 3.1po

Soil Layer Number = 5
 Depth below pile head = 288.000 in
 Depth below ground surface = 288.000 in
 Equivalent Depth = 353.617 in
 Pile Diameter = 48.000 in
 Cohesion, c = 4.340 lbs/in**2
 Avg Eff Unit Weight = .03329 lbs/in**3
 E50 parameter = .00985
 Default J parameter = .500
 Y50 = 1.18200 in
 p-multiplier = 1.00000
 y-multiplier = 1.00000
 Number of cycles of loading = 1000.
 Xr = 331.747 in

y, in	p, lbs/in
0.0000	0.0000
.0094560	171.0176
.2955000	538.6716
.5910000	678.6837
.8865000	776.8989
1.1820	855.0878
1.4775	921.1155
1.7730	978.8312
2.0685	1030.4417
2.3640	1077.3432
2.6595	1120.4821
2.9550	1160.5328
3.2505	1197.9949
3.5460	1231.3265
9.4560	1231.3265
17.7300	1231.3265
23.6400	1231.3265

p-y Curve Computed Using the Soft cLay Criteria for Cyclic Loading Conditions

Soil Layer Number = 5
 Depth below pile head = 396.000 in
 Depth below ground surface = 396.000 in
 Equivalent Depth = 461.617 in
 Pile Diameter = 48.000 in
 Cohesion, c = 5.903 lbs/in**2
 Avg Eff Unit Weight = .03307 lbs/in**3
 E50 parameter = .00850
 Default J parameter = .500
 Y50 = 1.02000 in
 p-multiplier = 1.00000
 y-multiplier = 1.00000
 Number of cycles of loading = 1000.
 Xr = 374.542 in

y, in	p, lbs/in
0.0000	0.0000
.0081600	255.0010
.2550000	803.2027
.5100000	1011.9720
.7650000	1158.4187
1.0200	1275.0048
1.2750	1373.4573
1.5300	1459.5162

	48 inch pipe - stratum 1 through 3.1po
1.7850	1536.4715
2.0400	1606.4054
2.2950	1670.7289
2.5500	1730.4478
2.8050	1786.3068
3.0600	1838.8751
8.1600	1836.0070
15.3000	1836.0070
20.4000	1836.0070

p-y Curve Computed Using the Soft Clay Criteria for Cyclic Loading Conditions

Soil Layer Number = 5
 Depth below pile head = 504.000 in
 Depth below ground surface = 504.000 in
 Equivalent Depth = 569.617 in
 Pile Diameter = 48.000 in
 Cohesion, c = 7.465 lbs/in**2
 Avg Eff Unit Weight = .03295 lbs/in**3
 E50 parameter = .00715
 Default J parameter = .500
 Y50 = .85800 in
 p-multiplier = 1.00000
 y-multiplier = 1.00000
 Number of cycles of loading = 1000.
 Xr = 404.574 in

y, in	p, lbs/in
0.0000	0.0000
.0068640	322.5005
.2145000	1015.8130
.4290000	1279.8442
.6435000	1465.0559
.8580000	1612.5026
1.0725	1737.0158
1.2870	1845.8547
1.5015	1943.1804
1.7160	2031.6260
1.9305	2112.9762
2.1450	2188.5028
2.3595	2259.1479
2.5740	2325.6313
6.8640	2322.0039
12.8700	2322.0039
17.1600	2322.0039

p-y Curve Computed Using Cyclic Criteria for Stiff Clay without Free Water

Soil Layer Number = 6
 Depth below pile head = 528.000 in
 Depth below ground surface = 528.000 in
 Equivalent Depth = 336.597 in
 Diameter = 48.000 in
 Undrained cohesion, c = 7.63890 lbs/in**2
 Average Eff. Unit Weight = .03301 lbs/in**3
 Epsilon-50 = .00700
 Pct = 2919.006 lbs/in

48 inch pipe - stratum 1 through 3.1po

Pcd = 3300.005 lbs/in
 Pu = 2919.006 lbs/in
 y50 = .840 in
 p-multiplier = 1.00000
 y-multiplier = 1.00000
 Number of cycles of loading = 1000.

y, in	p, lbs/in
0.0000	0.0000
.0001344	126.8953
.0006720	189.7527
.0013440	225.6553
.0067200	337.4333
.0134400	401.2781
.0672000	600.0507
.1344000	713.5846
.3360000	897.2851
.6720000	1067.0578
1.0080	1180.8936
1.3440	1268.9528
3.3600	1595.6236
6.7200	1897.5270
13.4400	2256.5526
30.2400	2763.7012
47.0400	2919.0059

p-y Curve Computed Using Cyclic Criteria for Stiff Clay without Free Water

Soil Layer Number = 6
 Depth below pile head = 564.000 in
 Depth below ground surface = 564.000 in
 Equivalent Depth = 372.597 in
 Diameter = 48.000 in
 Undrained cohesion, c = 7.63890 lbs/in**2
 Average Eff. Unit Weight = .03322 lbs/in**3
 Epsilon-50 = .00700
 Pct = 3117.191 lbs/in
 Pcd = 3300.005 lbs/in
 Pu = 3117.191 lbs/in
 y50 = .840 in
 p-multiplier = 1.00000
 y-multiplier = 1.00000
 Number of cycles of loading = 1000.

y, in	p, lbs/in
0.0000	0.0000
.0001344	135.5108
.0006720	202.6359
.0013440	240.9761
.0067200	360.3433
.0134400	428.5228
.0672000	640.7910
.1344000	762.0332
.3360000	958.2061
.6720000	1139.5055
1.0080	1261.0701
1.3440	1355.1080
3.3600	1703.9581
6.7200	2026.3591
13.4400	2409.7607

48 inch pipe - stratum 1 through 3.lpo
 30.2400 2951.3421
 47.0400 3117.1911

p-y Curve Computed Using Cyclic Criteria for Stiff Clay without Free Water

Soil Layer Number = 6
 Depth below pile head = 600.000 in
 Depth below ground surface = 600.000 in
 Equivalent Depth = 408.597 in
 Diameter = 48.000 in
 Undrained cohesion, c = 7.63890 lbs/in**2
 Average Eff. Unit Weight = .03340 lbs/in**3
 Epsilon-50 = .00700
 Pct = 3315.601 lbs/in
 Pcd = 3300.005 lbs/in
 Pu = 3300.005 lbs/in
 y50 = .840 in
 p-multiplier = 1.00000
 y-multiplier = 1.00000
 Number of cycles of loading = 1000.

y, in	p, lbs/in
0.0000	0.0000
.0001344	143.4581
.0006720	214.5199
.0013440	255.1086
.0067200	381.4763
.0134400	453.6543
.0672000	678.3714
.1344000	806.7242
.3360000	1014.4019
.6720000	1206.3340
1.0080	1335.0280
1.3440	1434.5810
3.3600	1803.8901
6.7200	2145.1989
13.4400	2551.0858
30.2400	3124.4292
47.0400	3300.0048

p-y Curve Computed Using Cyclic Criteria for Stiff Clay without Free Water

Soil Layer Number = 7
 Depth below pile head = 624.000 in
 Depth below ground surface = 624.000 in
 Equivalent Depth = 373.460 in
 Diameter = 48.000 in
 Undrained cohesion, c = 9.59030 lbs/in**2
 Average Eff. Unit Weight = .03349 lbs/in**3
 Epsilon-50 = .00700
 Pct = 3772.149 lbs/in
 Pcd = 4143.010 lbs/in
 Pu = 3772.149 lbs/in
 y50 = .840 in
 p-multiplier = 1.00000
 y-multiplier = 1.00000
 Number of cycles of loading = 1000.

48 inch pipe - stratum 1 through 3.1po

y, in	p, lbs/in
0.0000	0.0000
.0001344	163.9832
.0006720	245.2120
.0013440	291.6079
.0067200	436.0555
.0134400	518.5603
.0672000	775.4286
.1344000	922.1452
.3360000	1159.5362
.6720000	1378.9287
1.0080	1526.0354
1.3440	1639.8318
3.3600	2061.9793
6.7200	2452.1204
13.4400	2916.0791
30.2400	3571.4529
47.0400	3772.1487

p-y Curve Computed Using Cyclic Criteria for Stiff Clay without Free Water

Soil Layer Number	=	7
Depth below pile head	=	720.000 in
Depth below ground surface	=	720.000 in
Equivalent Depth	=	469.460 in
Diameter	=	48.000 in
Undrained cohesion, c	=	9.59030 lbs/in**2
Average Eff. Unit Weight	=	.03376 lbs/in**3
Epsilon-50	=	.00700
Pct	=	4392.845 lbs/in
Pcd	=	4143.010 lbs/in
Pu	=	4143.010 lbs/in
y50	=	.840 in
p-multiplier	=	1.00000
y-multiplier	=	1.00000
Number of cycles of loading	=	1000.

y, in	p, lbs/in
0.0000	0.0000
.0001344	180.1053
.0006720	269.3202
.0013440	320.2775
.0067200	478.9266
.0134400	569.5429
.0672000	851.6653
.1344000	1012.8064
.3360000	1273.5366
.6720000	1514.4988
1.0080	1676.0684
1.3440	1801.0527
3.3600	2264.7039
6.7200	2693.2020
13.4400	3202.7750
30.2400	3922.5823
47.0400	4143.0096

p-y Curve Computed Using cyclic Criteria for Stiff Clay without Free Water

48 inch pipe - stratum 1 through 3.lpo

Soil Layer Number = 7
 Depth below pile head = 816.000 in
 Depth below ground surface = 816.000 in
 Equivalent Depth = 565.460 in
 Diameter = 48.000 in
 Undrained cohesion, c = 9.59030 lbs/in**2
 Average Eff. Unit Weight = .03396 lbs/in**3
 Epsilon-50 = .00700
 Pct = 5014.299 lbs/in
 Pcd = 4143.010 lbs/in
 Pu = 4143.010 lbs/in
 y50 = .840 in
 p-multiplier = 1.00000
 y-multiplier = 1.00000
 Number of cycles of loading = 1000.

y, in	p, lbs/in
0.0000	0.0000
.0001344	180.1053
.0006720	269.3202
.0013440	320.2775
.0067200	478.9266
.0134400	569.5429
.0672000	851.6653
.1344000	1012.8064
.3360000	1273.5366
.6720000	1514.4988
1.0080	1676.0684
1.3440	1801.0527
3.3600	2264.7039
6.7200	2693.2020
13.4400	3202.7750
30.2400	3922.5823
47.0400	4143.0096

p-y Curve Computed Using Cyclic Criteria for Stiff Clay without Free Water

Soil Layer Number = 8
 Depth below pile head = 840.000 in
 Depth below ground surface = 840.000 in
 Equivalent Depth = 662.921 in
 Diameter = 48.000 in
 Undrained cohesion, c = 7.84720 lbs/in**2
 Average Eff. Unit Weight = .03394 lbs/in**3
 Epsilon-50 = .00700
 Pct = 4811.147 lbs/in
 Pcd = 3389.990 lbs/in
 Pu = 3389.990 lbs/in
 y50 = .840 in
 p-multiplier = 1.00000
 y-multiplier = 1.00000
 Number of cycles of loading = 1000.

y, in	p, lbs/in
0.0000	0.0000
.0001344	147.3700
.0006720	220.3695

48 inch pipe - stratum 1 through 3.lpo

.0013440	262.0650
.0067200	391.8785
.0134400	466.0247
.0672000	696.8695
.1344000	828.7222
.3360000	1042.0630
.6720000	1239.2287
1.0080	1371.4320
1.3440	1473.6996
3.3600	1853.0791
6.7200	2203.6949
13.4400	2620.6496
30.2400	3209.6272
47.0400	3389.9904

p-y Curve Computed Using Cyclic Criteria for Stiff Clay without Free Water

Soil Layer Number = 8
 Depth below pile head = 1020.000 in
 Depth below ground surface = 1020.000 in
 Equivalent Depth = 842.921 in
 Diameter = 48.000 in
 Undrained cohesion, c = 7.84720 lbs/in**2
 Average Eff. Unit Weight = .03344 lbs/in**3
 Epsilon-50 = .00700
 Pct = 5790.366 lbs/in
 Pcd = 3389.990 lbs/in
 Pu = 3389.990 lbs/in
 y50 = .840 in
 p-multiplier = 1.00000
 y-multiplier = 1.00000
 Number of cycles of loading = 1000.

y, in	p, lbs/in
0.0000	0.0000
.0001344	147.3700
.0006720	220.3695
.0013440	262.0650
.0067200	391.8785
.0134400	466.0247
.0672000	696.8695
.1344000	828.7222
.3360000	1042.0630
.6720000	1239.2287
1.0080	1371.4320
1.3440	1473.6996
3.3600	1853.0791
6.7200	2203.6949
13.4400	2620.6496
30.2400	3209.6272
47.0400	3389.9904

p-y Curve Computed Using Cyclic Criteria for Stiff Clay without Free Water

Soil Layer Number = 8
 Depth below pile head = 1200.000 in
 Depth below ground surface = 1200.000 in
 Equivalent Depth = 1022.921 in
 Diameter = 48.000 in
 Undrained cohesion, c = 7.84720 lbs/in**2

48 inch pipe - stratum 1 through 3.1po

Average Eff. Unit Weight = .03309 lbs/in**3
 Epsilon-50 = .00700
 Pct = 6768.304 lbs/in
 Pcd = 3389.990 lbs/in
 Pu = 3389.990 lbs/in
 y50 = .840 in
 p-multiplier = 1.00000
 y-multiplier = 1.00000
 Number of cycles of loading = 1000.

y, in	p, lbs/in
0.0000	0.0000
.0001344	147.3700
.0006720	220.3695
.0013440	262.0650
.0067200	391.8785
.0134400	466.0247
.0672000	696.8695
.1344000	828.7222
.3360000	1042.0630
.6720000	1239.2287
1.0080	1371.4320
1.3440	1473.6996
3.3600	1853.0791
6.7200	2203.6949
13.4400	2620.6496
30.2400	3209.6272
47.0400	3389.9904

p-y Curve Computed Using Cyclic Criteria for Stiff Clay without Free Water

Soil Layer Number = 9
 Depth below pile head = 1224.000 in
 Depth below ground surface = 1224.000 in
 Equivalent Depth = 826.020 in
 Diameter = 48.000 in
 Undrained cohesion, c = 10.59030 lbs/in**2
 Average Eff. Unit Weight = .03305 lbs/in**3
 Epsilon-50 = .00700
 Pct = 7209.108 lbs/in
 Pcd = 4575.010 lbs/in
 Pu = 4575.010 lbs/in
 y50 = .840 in
 p-multiplier = 1.00000
 y-multiplier = 1.00000
 Number of cycles of loading = 1000.

y, in	p, lbs/in
0.0000	0.0000
.0001344	198.8852
.0006720	297.4028
.0013440	353.6735
.0067200	528.8652
.0134400	628.9303
.0672000	940.4701
.1344000	1118.4137
.3360000	1406.3308

	48 inch pipe - stratum 1 through 3.1po
.6720000	1672.4186
1.0080	1850.8355
1.3440	1988.8522
3.3600	2500.8492
6.7200	2974.0276
13.4400	3536.7348
30.2400	4331.5979
47.0400	4575.0096

p-y Curve Computed Using Cyclic Criteria for Stiff Clay without Free Water

Soil Layer Number = 9
 Depth below pile head = 1284.000 in
 Depth below ground surface = 1284.000 in
 Equivalent Depth = 886.020 in
 Diameter = 48.000 in
 Undrained cohesion, c = 10.59030 lbs/in**2
 Average Eff. Unit Weight = .03292 lbs/in**3
 Epsilon-50 = .00700
 Pct = 7616.730 lbs/in
 Pcd = 4575.010 lbs/in
 Pu = 4575.010 lbs/in
 y50 = .840 in
 p-multiplier = 1.00000
 y-multiplier = 1.00000
 Number of cycles of loading = 1000.

y, in	p, lbs/in
0.0000	0.0000
.0001344	198.8852
.0006720	297.4028
.0013440	353.6735
.0067200	528.8652
.0134400	628.9303
.0672000	940.4701
.1344000	1118.4137
.3360000	1406.3308
.6720000	1672.4186
1.0080	1850.8355
1.3440	1988.8522
3.3600	2500.8492
6.7200	2974.0276
13.4400	3536.7348
30.2400	4331.5979
47.0400	4575.0096

p-y Curve Computed Using Cyclic Criteria for Stiff Clay without Free Water

Soil Layer Number = 9
 Depth below pile head = 1344.000 in
 Depth below ground surface = 1344.000 in
 Equivalent Depth = 946.020 in
 Diameter = 48.000 in
 Undrained cohesion, c = 10.59030 lbs/in**2
 Average Eff. Unit Weight = .03281 lbs/in**3
 Epsilon-50 = .00700
 Pct = 8024.141 lbs/in
 Pcd = 4575.010 lbs/in
 Pu = 4575.010 lbs/in
 y50 = .840 in

48 inch pipe - stratum 1 through 3.lpo

p-multiplier = 1.00000
 y-multiplier = 1.00000
 Number of cycles of loading = 1000.

y, in	p, lbs/in
0.0000	0.0000
.0001344	198.8852
.0006720	297.4028
.0013440	353.6735
.0067200	528.8652
.0134400	628.9303
.0672000	940.4701
.1344000	1118.4137
.3360000	1406.3308
.6720000	1672.4186
1.0080	1850.8355
1.3440	1988.8522
3.3600	2500.8492
6.7200	2974.0276
13.4400	3536.7348
30.2400	4331.5979
47.0400	4575.0096

p-y Curve Computed Using Cyclic Criteria for Stiff Clay without Free Water

Soil Layer Number = 10
 Depth below pile head = 1524.000 in
 Depth below ground surface = 1524.000 in
 Equivalent Depth = 920.012 in
 Diameter = 48.000 in
 Undrained cohesion, c = 14.34720 lbs/in**2
 Average Eff. Unit weight = .03298 lbs/in**3
 Epsilon-50 = .00500
 Pct = 10122.049 lbs/in
 Pcd = 6197.990 lbs/in
 Pu = 6197.990 lbs/in
 y50 = .600 in
 p-multiplier = 1.00000
 y-multiplier = 1.00000
 Number of cycles of loading = 1000.

y, in	p, lbs/in
0.0000	0.0000
9.6000E-05	269.4396
.0004800	402.9061
.0009600	479.1388
.0048000	716.4797
.0096000	852.0428
.0480000	1274.1011
.0960000	1515.1701
.2400000	1905.2255
.4800000	2265.7078
.7200000	2507.4178
.9600000	2694.3958
2.4000	3388.0233
4.8000	4029.0614
9.6000	4791.3885

48 inch pipe - stratum 1 through 3.lpo
 21.6000 5868.2286
 33.6000 6197.9904

p-y Curve Computed Using Cyclic Criteria for Stiff Clay without Free Water

Soil Layer Number = 10
 Depth below pile head = 1690.000 in
 Depth below ground surface = 1690.000 in
 Equivalent Depth = 1086.012 in
 Diameter = 48.000 in
 Undrained cohesion, c = 14.34720 lbs/in**2
 Average Eff. Unit Weight = .03313 lbs/in**3
 Epsilon-50 = .00500
 Pct = 11583.424 lbs/in
 Pcd = 6197.990 lbs/in
 Pu = 6197.990 lbs/in
 y50 = .600 in
 p-multiplier = 1.00000
 y-multiplier = 1.00000
 Number of cycles of loading = 1000.

y, in	p, lbs/in
0.0000	0.0000
9.6000E-05	269.4396
.0004800	402.9061
.0009600	479.1388
.0048000	716.4797
.0096000	852.0428
.0480000	1274.1011
.0960000	1515.1701
.2400000	1905.2255
.4800000	2265.7078
.7200000	2507.4178
.9600000	2694.3958
2.4000	3388.0233
4.8000	4029.0614
9.6000	4791.3885
21.6000	5868.2286
33.6000	6197.9904

 Computed Values of Load Distribution and Deflection
 for Lateral Loading for Load Case Number 1

Pile-head boundary conditions are Shear and Moment (BC Type 1)
 Specified shear force at pile head = .000 lbs
 Specified moment at pile head = .000 in-lbs
 Specified axial load at pile head = .000 lbs

(Zero moment for this load indicates free-head conditions)

Depth	Deflect.	Moment	Shear	Slope	Total	Soil Res.
Es*h	y	M	V	S	Stress	p
F/L	in	lbs-in	lbs	Rad.	lbs/in**2	lbs/in

48 inch pipe - stratum 1 through 3.1po

lbs/in

0.000	0.000	0.0000	0.0000	0.0000	0.0000	0.0000
0.0000						
16.900	0.000	0.0000	0.0000	0.0000	0.0000	0.0000
15879.9160						
33.800	0.000	0.0000	0.0000	0.0000	0.0000	0.0000
31759.8320						
50.700	0.000	0.0000	0.0000	0.0000	0.0000	0.0000
292434.						
67.600	0.000	0.0000	0.0000	0.0000	0.0000	0.0000
322017.						
84.500	0.000	0.0000	0.0000	0.0000	0.0000	0.0000
351600.						
101.400	0.000	0.0000	0.0000	0.0000	0.0000	0.0000
381183.						
118.300	0.000	0.0000	0.0000	0.0000	0.0000	0.0000
410766.						
135.200	0.000	0.0000	0.0000	0.0000	0.0000	0.0000
440349.						
152.100	0.000	0.0000	0.0000	0.0000	0.0000	0.0000
469932.						
169.000	0.000	0.0000	0.0000	0.0000	0.0000	0.0000
499516.						
185.900	0.000	0.0000	0.0000	0.0000	0.0000	0.0000
149071.						
202.800	0.000	0.0000	0.0000	0.0000	0.0000	0.0000
164950.						
219.700	0.000	0.0000	0.0000	0.0000	0.0000	0.0000
739783.						
236.600	0.000	0.0000	0.0000	0.0000	0.0000	0.0000
775217.						
253.500	0.000	0.0000	0.0000	0.0000	0.0000	0.0000
810650.						
270.400	0.000	0.0000	0.0000	0.0000	0.0000	0.0000
846084.						
287.300	0.000	0.0000	0.0000	0.0000	0.0000	0.0000
1399514.						
304.200	0.000	0.0000	0.0000	0.0000	0.0000	0.0000
1521583.						
321.100	0.000	0.0000	0.0000	0.0000	0.0000	0.0000
1649053.						
338.000	0.000	0.0000	0.0000	0.0000	0.0000	0.0000
1782093.						
354.900	0.000	0.0000	0.0000	0.0000	0.0000	0.0000
1920886.						
371.800	0.000	0.0000	0.0000	0.0000	0.0000	0.0000
2045190.						
388.700	0.000	0.0000	0.0000	0.0000	0.0000	0.0000
2152606.						
405.600	0.000	0.0000	0.0000	0.0000	0.0000	0.0000
2262088.						
422.500	0.000	0.0000	0.0000	0.0000	0.0000	0.0000
2373749.						
439.400	0.000	0.0000	0.0000	0.0000	0.0000	0.0000
2487708.						
456.300	0.000	0.0000	0.0000	0.0000	0.0000	0.0000
2604096.						
473.200	0.000	0.0000	0.0000	0.0000	0.0000	0.0000
2723054.						
490.100	0.000	0.0000	0.0000	0.0000	0.0000	0.0000
2844737.						

48 inch pipe - stratum 1 through 3.1po						
507.000	0.000	0.0000	0.0000	0.0000	0.0000	0.0000
2969314.						
523.900	0.000	0.0000	0.0000	0.0000	0.0000	0.0000
4687590.						
540.800	0.000	0.0000	0.0000	0.0000	0.0000	0.0000
4838088.						
557.700	0.000	0.0000	0.0000	0.0000	0.0000	0.0000
4988676.						
574.600	0.000	0.0000	0.0000	0.0000	0.0000	0.0000
5139347.						
591.500	0.000	0.0000	0.0000	0.0000	0.0000	0.0000
5290093.						
608.400	0.000	0.0000	0.0000	0.0000	0.0000	0.0000
5340698.						
625.300	0.000	0.0000	0.0000	0.0000	0.0000	0.0000
6118404.						
642.200	0.000	0.0000	0.0000	0.0000	0.0000	0.0000
6295134.						
659.100	0.000	0.0000	0.0000	0.0000	0.0000	0.0000
6471916.						
676.000	0.000	0.0000	0.0000	0.0000	0.0000	0.0000
6648748.						
692.900	0.000	0.0000	0.0000	0.0000	0.0000	0.0000
6705010.						
709.800	0.000	0.0000	0.0000	0.0000	0.0000	0.0000
6705010.						
726.700	0.000	0.0000	0.0000	0.0000	0.0000	0.0000
6705010.						
743.600	0.000	0.0000	0.0000	0.0000	0.0000	0.0000
6705010.						
760.500	0.000	0.0000	0.0000	0.0000	0.0000	0.0000
6705010.						
777.400	0.000	0.0000	0.0000	0.0000	0.0000	0.0000
6705010.						
794.300	0.000	0.0000	0.0000	0.0000	0.0000	0.0000
6705010.						
811.200	0.000	0.0000	0.0000	0.0000	0.0000	0.0000
6705010.						
828.100	0.000	0.0000	0.0000	0.0000	0.0000	0.0000
5486330.						
845.000	0.000	0.0000	0.0000	0.0000	0.0000	0.0000
5486330.						
861.900	0.000	0.0000	0.0000	0.0000	0.0000	0.0000
5486330.						
878.800	0.000	0.0000	0.0000	0.0000	0.0000	0.0000
5486330.						
895.700	0.000	0.0000	0.0000	0.0000	0.0000	0.0000
5486330.						
912.600	0.000	0.0000	0.0000	0.0000	0.0000	0.0000
5486330.						
929.500	0.000	0.0000	0.0000	0.0000	0.0000	0.0000
5486330.						
946.400	0.000	0.0000	0.0000	0.0000	0.0000	0.0000
5486330.						
963.300	0.000	0.0000	0.0000	0.0000	0.0000	0.0000
5486330.						
980.200	0.000	0.0000	0.0000	0.0000	0.0000	0.0000
5486330.						
997.100	0.000	0.0000	0.0000	0.0000	0.0000	0.0000
5486330.						
1014.	0.000	0.0000	0.0000	0.0000	0.0000	0.0000
5486330.						
1031.	0.000	0.0000	0.0000	0.0000	0.0000	0.0000

48 inch pipe - stratum 1 through 3.lpo

5486330.						
1048.	0.000	0.0000	0.0000	0.0000	0.0000	0.0000
5486330.						
1065.	0.000	0.0000	0.0000	0.0000	0.0000	0.0000
5486330.						
1082.	0.000	0.0000	0.0000	0.0000	0.0000	0.0000
5486330.						
1099.	0.000	0.0000	0.0000	0.0000	0.0000	0.0000
5486330.						
1115.	0.000	0.0000	0.0000	0.0000	0.0000	0.0000
5486330.						
1132.	0.000	0.0000	0.0000	0.0000	0.0000	0.0000
5486330.						
1149.	0.000	0.0000	0.0000	0.0000	0.0000	0.0000
5486330.						
1166.	0.000	0.0000	0.0000	0.0000	0.0000	0.0000
5486330.						
1183.	0.000	0.0000	0.0000	0.0000	0.0000	0.0000
5486330.						
1200.	0.000	0.0000	0.0000	0.0000	0.0000	0.0000
5486330.						
1217.	0.000	0.0000	0.0000	0.0000	0.0000	0.0000
7404154.						
1234.	0.000	0.0000	0.0000	0.0000	0.0000	0.0000
7404154.						
1251.	0.000	0.0000	0.0000	0.0000	0.0000	0.0000
7404154.						
1268.	0.000	0.0000	0.0000	0.0000	0.0000	0.0000
7404154.						
1284.	0.000	0.0000	0.0000	0.0000	0.0000	0.0000
7404154.						
1301.	0.000	0.0000	0.0000	0.0000	0.0000	0.0000
7404154.						
1318.	0.000	0.0000	0.0000	0.0000	0.0000	0.0000
7404154.						
1335.	0.000	0.0000	0.0000	0.0000	0.0000	0.0000
7404154.						
1352.	0.000	0.0000	0.0000	0.0000	0.0000	0.0000
7404154.						
1369.	0.000	0.0000	0.0000	0.0000	0.0000	0.0000
1.0911E+07						
1386.	0.000	0.0000	0.0000	0.0000	0.0000	0.0000
1.0911E+07						
1403.	0.000	0.0000	0.0000	0.0000	0.0000	0.0000
1.0911E+07						
1420.	0.000	0.0000	0.0000	0.0000	0.0000	0.0000
1.0911E+07						
1436.	0.000	0.0000	0.0000	0.0000	0.0000	0.0000
1.0911E+07						
1453.	0.000	0.0000	0.0000	0.0000	0.0000	0.0000
1.0911E+07						
1470.	0.000	0.0000	0.0000	0.0000	0.0000	0.0000
1.0911E+07						
1487.	0.000	0.0000	0.0000	0.0000	0.0000	0.0000
1.0911E+07						
1504.	0.000	0.0000	0.0000	0.0000	0.0000	0.0000
1.0911E+07						
1521.	0.000	0.0000	0.0000	0.0000	0.0000	0.0000
1.0911E+07						
1538.	0.000	0.0000	0.0000	0.0000	0.0000	0.0000
1.0911E+07						
1555.	0.000	0.0000	0.0000	0.0000	0.0000	0.0000
1.0911E+07						

		48 inch pipe - stratum 1 through 3.1po					
1572.	0.000	0.0000	0.0000	0.0000	0.0000	0.0000	0.0000
1.0911E+07							
1589.	0.000	0.0000	0.0000	0.0000	0.0000	0.0000	0.0000
1.0911E+07							
1605.	0.000	0.0000	0.0000	0.0000	0.0000	0.0000	0.0000
1.0911E+07							
1622.	0.000	0.0000	0.0000	0.0000	0.0000	0.0000	0.0000
1.0911E+07							
1639.	0.000	0.0000	0.0000	0.0000	0.0000	0.0000	0.0000
1.0911E+07							
1656.	0.000	0.0000	0.0000	0.0000	0.0000	0.0000	0.0000
1.0911E+07							
1673.	0.000	0.0000	0.0000	0.0000	0.0000	0.0000	0.0000
1.0911E+07							
1690.	0.000	0.0000	0.0000	0.0000	0.0000	0.0000	0.0000
5455523.							

Output Verification:

Computed forces and moments are within specified convergence limits.

Output Summary for Load Case No. 1:

Pile-head deflection	=	0.00000 in
Computed slope at pile head	=	0.00000
Maximum bending moment	=	0.00000 lbs-in
Maximum shear force	=	0.00000 lbs
Depth of maximum bending moment	=	0.00000 in
Depth of maximum shear force	=	0.00000 in
Number of iterations	=	5
Number of zero deflection points	=	0

 Summary of Pile Response(s)

Definition of Symbols for Pile-Head Loading Conditions:

Type 1 = Shear and Moment,	y = pile-head displacement in
Type 2 = Shear and Slope,	M = Pile-head Moment lbs-in
Type 3 = Shear and Rot. Stiffness,	V = Pile-head Shear Force lbs
Type 4 = Deflection and Moment,	S = Pile-head Slope, radians
Type 5 = Deflection and Slope,	R = Rot. Stiffness of Pile-head in-lbs/rad

Load Type	Pile-Head Condition 1	Pile-Head Condition 2	Axial Load lbs	Pile-Head Deflection in	Maximum Moment in-lbs	Maximum Shear lbs
1	V= 0.000	M= 0.000	0.0000	0.0000	0.0000	0.0000

The analysis ended normally.

48 inch pipe - stratum 5 through 7

LPILE Plus for Windows, Version 5.0 (5.0.30)
Analysis of Individual Piles and Drilled Shafts
Subjected to Lateral Loading Using the p-y Method

(c) 1985-2007 by Ensoft, Inc.
All Rights Reserved

This program is licensed to:

DJI
Eustis

Path to file locations: U:\sys\WPDATA\Projects\20749\Piles\LPile\
Name of input data file: 48 inch pipe - stratum 5 through 7.lpd
Name of output file: 48 inch pipe - stratum 5 through 7.lpo
Name of plot output file: 48 inch pipe - stratum 5 through 7.lpp
Name of runtime file: 48 inch pipe - stratum 5 through 7.lpr

Time and Date of Analysis

Date: November 9, 2009 Time: 15:43:36

Problem Title

EE20749 - St. Mary Floodgate Structure at Franklin Drainage Canal

Program Options

Units Used in Computations - US Customary Units: Inches, Pounds

Basic Program Options:

Analysis Type 1:

- Computation of Lateral Pile Response Using User-specified Constant EI

Computation Options:

- Only internally-generated p-y curves used in analysis
- Analysis does not use p-y multipliers (individual pile or shaft action only)
- Analysis assumes no shear resistance at pile tip
- Analysis for fixed-length pile or shaft only
- No computation of foundation stiffness matrix elements
- Output pile response for full length of pile
- Analysis assumes no soil movements acting on pile
- Additional p-y curves computed at specified depths

Solution Control Parameters:

- Number of pile increments = 100
- Maximum number of iterations allowed = 100

48 inch pipe - stratum 5 through 7

- Deflection tolerance for convergence = 1.0000E-05 in
- Maximum allowable deflection = 1.0000E+02 in

Printing Options:

- Values of pile-head deflection, bending moment, shear force, and soil reaction are printed for full length of pile.
- Printing Increment (spacing of output points) = 1

Pile Structural Properties and Geometry

Pile Length = 1690.00 in
Depth of ground surface below top of pile = .00 in
Slope angle of ground surface = .00 deg.

Structural properties of pile defined using 2 points

Point	Depth X in	Pile Diameter in	Moment of Inertia in**4	Pile Area Sq.in	Modulus of Elasticity lbs/Sq.in
1	0.0000	48.00000000	260576.3000	74.6000	30000.00000
2	1690.0000	48.00000000	260576.3000	74.6000	30000.00000

Soil and Rock Layering Information

The soil profile is modelled using 10 layers

Layer 1 is silt with cohesion and friction
Distance from top of pile to top of layer = .000 in
Distance from top of pile to bottom of layer = 36.000 in
p-y subgrade modulus k for top of soil layer = 55.600 lbs/in**3
p-y subgrade modulus k for bottom of layer = 55.600 lbs/in**3

Layer 2 is soft clay, p-y criteria by Matlock, 1970
Distance from top of pile to top of layer = 36.000 in
Distance from top of pile to bottom of layer = 180.000 in

Layer 3 is silt with cohesion and friction
Distance from top of pile to top of layer = 180.000 in
Distance from top of pile to bottom of layer = 204.000 in
p-y subgrade modulus k for top of soil layer = 55.600 lbs/in**3
p-y subgrade modulus k for bottom of layer = 55.600 lbs/in**3

Layer 4 is soft clay, p-y criteria by Matlock, 1970
Distance from top of pile to top of layer = 204.000 in
Distance from top of pile to bottom of layer = 276.000 in

Layer 5 is soft clay, p-y criteria by Matlock, 1970
Distance from top of pile to top of layer = 276.000 in
Distance from top of pile to bottom of layer = 516.000 in

Layer 6 is stiff clay without free water
Distance from top of pile to top of layer = 516.000 in
Distance from top of pile to bottom of layer = 612.000 in

Layer 7 is stiff clay without free water
Distance from top of pile to top of layer = 612.000 in

48 inch pipe - stratum 5 through 7
 Distance from top of pile to bottom of layer = 828.000 in

Layer 8 is stiff clay without free water
 Distance from top of pile to top of layer = 828.000 in
 Distance from top of pile to bottom of layer = 1212.000 in

Layer 9 is stiff clay without free water
 Distance from top of pile to top of layer = 1212.000 in
 Distance from top of pile to bottom of layer = 1356.000 in

Layer 10 is stiff clay without free water
 Distance from top of pile to top of layer = 1356.000 in
 Distance from top of pile to bottom of layer = 1692.000 in

(Depth of lowest layer extends 2.00 in below pile tip)

 Effective Unit Weight of Soil vs. Depth

Distribution of effective unit weight of soil with depth
 is defined using 20 points

Point No.	Depth X in	Eff. Unit Weight lbs/in**3
1	.00	.03160
2	36.00	.03160
3	36.00	.03330
4	180.00	.03330
5	180.00	.03160
6	204.00	.03160
7	204.00	.03480
8	276.00	.03480
9	276.00	.03250
10	516.00	.03250
11	516.00	.03620
12	612.00	.03620
13	612.00	.03550
14	828.00	.03550
15	828.00	.03110
16	1212.00	.03110
17	1212.00	.03040
18	1356.00	.03040
19	1356.00	.03450
20	1692.00	.03450

 Shear Strength of Soils

Distribution of shear strength parameters with depth
 defined using 20 points

Point No.	Depth X in	Cohesion c lbs/in**2	Angle of Friction Deg.	E50 or k_rm	RQD %
1	.000	1.38890	15.00	.02000	.0
2	36.000	1.38890	15.00	.02000	.0

48 inch pipe - stratum 5 through 7					
3	36.000	2.20140	.00	.02000	.0
4	180.000	2.20140	.00	.02000	.0
5	180.000	1.38890	15.00	.02000	.0
6	204.000	1.38890	15.00	.02000	.0
7	204.000	3.12500	.00	.02000	.0
8	276.000	3.12500	.00	.02000	.0
9	276.000	4.16670	.00	.01000	.0
10	516.000	7.63890	.00	.00700	.0
11	516.000	7.63890	.00	.00700	.0
12	612.000	7.63890	.00	.00700	.0
13	612.000	9.59030	.00	.00700	.0
14	828.000	9.59030	.00	.00700	.0
15	828.000	7.84720	.00	.00700	.0
16	1212.000	7.84720	.00	.00700	.0
17	1212.000	10.59030	.00	.00700	.0
18	1356.000	10.59030	.00	.00700	.0
19	1356.000	14.34720	.00	.00500	.0
20	1692.000	14.34720	.00	.00500	.0

Notes:

- (1) Cohesion = uniaxial compressive strength for rock materials.
- (2) Values of E50 are reported for clay strata.
- (3) Default values will be generated for E50 when input values are 0.
- (4) RQD and k_{rm} are reported only for weak rock strata.

Loading Type

Cyclic loading criteria was used for computation of p-y curves

Number of cycles of loading = 1000.

Pile-head Loading and Pile-head Fixity Conditions

Number of loads specified = 1

Load Case Number 1

Pile-head boundary conditions are Shear and Moment (BC Type 1)

Shear force at pile head = 1000.000 lbs
Bending moment at pile head = 1000.000 in-lbs
Axial load at pile head = 1000.000 lbs

Non-zero moment at pile head for this load case indicates the pile-head may rotate under the applied pile-head loading, but is not a free-head (zero moment) condition.

Output of p-y Curves at Specified Depths

48 inch pipe - stratum 5 through 7

p-y curves are generated and printed for verification at 9 depths.

Depth No.	Depth Below Pile Head in	Depth Below Ground Surface in
1	288.000	288.000
2	396.000	396.000
3	504.000	504.000
4	528.000	528.000
5	564.000	564.000
6	600.000	600.000
7	624.000	624.000
8	720.000	720.000
9	816.000	816.000

Depth of ground surface below top of pile = .00 in

p-y Curve Computed Using the Soft Clay Criteria for Cyclic Loading Conditions

Soil Layer Number = 5
 Depth below pile head = 288.000 in
 Depth below ground surface = 288.000 in
 Equivalent Depth = 353.617 in
 Pile Diameter = 48.000 in
 Cohesion, c = 4.340 lbs/in**2
 Avg Eff Unit Weight = .03329 lbs/in**3
 E50 parameter = .00985
 Default J parameter = .500
 Y50 = 1.18200 in
 p-multiplier = 1.00000
 y-multiplier = 1.00000
 Number of cycles of loading = 1000.
 Xr = 331.747 in

y, in	p, lbs/in
0.0000	0.0000
.0094560	171.0176
.2955000	538.6716
.5910000	678.6837
.8865000	776.8989
1.1820	855.0878
1.4775	921.1155
1.7730	978.8312
2.0685	1030.4417
2.3640	1077.3432
2.6595	1120.4821
2.9550	1160.5328
3.2505	1197.9949
3.5460	1231.3265
9.4560	1231.3265
17.7300	1231.3265
23.6400	1231.3265

p-y Curve Computed Using the Soft Clay Criteria for Cyclic Loading Conditions

Soil Layer Number = 5
 Depth below pile head = 396.000 in
 Depth below ground surface = 396.000 in

48 inch pipe - stratum 5 through 7

```

Equivalent Depth      = 461.617 in
Pile Diameter         = 48.000 in
Cohesion, c          = 5.903 lbs/in**2
Avg Eff Unit Weight  = .03307 lbs/in**3
E50 parameter         = .00850
Default J parameter   = .500
Y50                  = 1.02000 in
p-multiplier         = 1.00000
y-multiplier         = 1.00000
Number of cycles of loading = 1000.
Xr                   = 374.542 in

```

y, in	p, lbs/in
0.0000	0.0000
.0081600	255.0010
.2550000	803.2027
.5100000	1011.9720
.7650000	1158.4187
1.0200	1275.0048
1.2750	1373.4573
1.5300	1459.5162
1.7850	1536.4715
2.0400	1606.4054
2.2950	1670.7289
2.5500	1730.4478
2.8050	1786.3068
3.0600	1838.8751
8.1600	1836.0070
15.3000	1836.0070
20.4000	1836.0070

p-y Curve Computed Using the Soft Clay Criteria for Cyclic Loading Conditions

```

Soil Layer Number    = 5
Depth below pile head = 504.000 in
Depth below ground surface = 504.000 in
Equivalent Depth     = 569.617 in
Pile Diameter        = 48.000 in
Cohesion, c         = 7.465 lbs/in**2
Avg Eff Unit Weight = .03295 lbs/in**3
E50 parameter        = .00715
Default J parameter   = .500
Y50                  = .85800 in
p-multiplier         = 1.00000
y-multiplier         = 1.00000
Number of cycles of loading = 1000.
Xr                   = 404.574 in

```

y, in	p, lbs/in
0.0000	0.0000
.0068640	322.5005
.2145000	1015.8130
.4290000	1279.8442
.6435000	1465.0559
.8580000	1612.5026
1.0725	1737.0158
1.2870	1845.8547
1.5015	1943.1804
1.7160	2031.6260
1.9305	2112.9762

	48 inch pipe - stratum 5 through 7
2.1450	2188.5028
2.3595	2259.1479
2.5740	2325.6313
6.8640	2322.0039
12.8700	2322.0039
17.1600	2322.0039

p-y Curve Computed Using Cyclic Criteria for Stiff Clay without Free Water

Soil Layer Number	=	6
Depth below pile head	=	528.000 in
Depth below ground surface	=	528.000 in
Equivalent Depth	=	336.597 in
Diameter	=	48.000 in
Undrained cohesion, c	=	7.63890 lbs/in**2
Average Eff. Unit Weight	=	.03301 lbs/in**3
Epsilon-50	=	.00700
Pct	=	2919.006 lbs/in
Pcd	=	3300.005 lbs/in
Pu	=	2919.006 lbs/in
y50	=	.840 in
p-multiplier	=	1.00000
y-multiplier	=	1.00000
Number of cycles of loading	=	1000.

y, in	p, lbs/in
0.0000	0.0000
.0001344	126.8953
.0006720	189.7527
.0013440	225.6553
.0067200	337.4333
.0134400	401.2781
.0672000	600.0507
.1344000	713.5846
.3360000	897.2851
.6720000	1067.0578
1.0080	1180.8936
1.3440	1268.9528
3.3600	1595.6236
6.7200	1897.5270
13.4400	2256.5526
30.2400	2763.7012
47.0400	2919.0059

p-y Curve Computed Using Cyclic Criteria for Stiff Clay without Free Water

Soil Layer Number	=	6
Depth below pile head	=	564.000 in
Depth below ground surface	=	564.000 in
Equivalent Depth	=	372.597 in
Diameter	=	48.000 in
Undrained cohesion, c	=	7.63890 lbs/in**2
Average Eff. Unit Weight	=	.03322 lbs/in**3
Epsilon-50	=	.00700
Pct	=	3117.191 lbs/in
Pcd	=	3300.005 lbs/in
Pu	=	3117.191 lbs/in

Page 7

48 inch pipe - stratum 5 through 7

y50 = .840 in
 p-multiplier = 1.00000
 y-multiplier = 1.00000
 Number of cycles of loading = 1000.

y, in	p, lbs/in
0.0000	0.0000
.0001344	135.5108
.0006720	202.6359
.0013440	240.9761
.0067200	360.3433
.0134400	428.5228
.0672000	640.7910
.1344000	762.0332
.3360000	958.2061
.6720000	1139.5055
1.0080	1261.0701
1.3440	1355.1080
3.3600	1703.9581
6.7200	2026.3591
13.4400	2409.7607
30.2400	2951.3421
47.0400	3117.1911

p-y Curve Computed Using Cyclic Criteria for Stiff Clay without Free Water

Soil Layer Number = 6
 Depth below pile head = 600.000 in
 Depth below ground surface = 600.000 in
 Equivalent Depth = 408.597 in
 Diameter = 48.000 in
 Undrained cohesion, c = 7.63890 lbs/in**2
 Average Eff. Unit Weight = .03340 lbs/in**3
 Epsilon-50 = .00700
 Pct = 3315.601 lbs/in
 Pcd = 3300.005 lbs/in
 Pu = 3300.005 lbs/in
 y50 = .840 in
 p-multiplier = 1.00000
 y-multiplier = 1.00000
 Number of cycles of loading = 1000.

y, in	p, lbs/in
0.0000	0.0000
.0001344	143.4581
.0006720	214.5199
.0013440	255.1086
.0067200	381.4763
.0134400	453.6543
.0672000	678.3714
.1344000	806.7242
.3360000	1014.4019
.6720000	1206.3340
1.0080	1335.0280
1.3440	1434.5810
3.3600	1803.8901
6.7200	2145.1989
13.4400	2551.0858
30.2400	3124.4292
47.0400	3300.0048

48 inch pipe - stratum 5 through 7

p-y Curve Computed Using Cyclic Criteria for Stiff Clay without Free Water

Soil Layer Number = 7
 Depth below pile head = 624.000 in
 Depth below ground surface = 624.000 in
 Equivalent Depth = 373.460 in
 Diameter = 48.000 in
 Undrained cohesion, c = 9.59030 lbs/in**2
 Average Eff. Unit Weight = .03349 lbs/in**3
 Epsilon-50 = .00700
 Pct = 3772.149 lbs/in
 Pcd = 4143.010 lbs/in
 Pu = 3772.149 lbs/in
 y50 = .840 in
 p-multiplier = 1.00000
 y-multiplier = 1.00000
 Number of cycles of loading = 1000.

y, in	p, lbs/in
0.0000	0.0000
.0001344	163.9832
.0006720	245.2120
.0013440	291.6079
.0067200	436.0555
.0134400	518.5603
.0672000	775.4286
.1344000	922.1452
.3360000	1159.5362
.6720000	1378.9287
1.0080	1526.0354
1.3440	1639.8318
3.3600	2061.9793
6.7200	2452.1204
13.4400	2916.0791
30.2400	3571.4529
47.0400	3772.1487

p-y Curve Computed Using Cyclic Criteria for Stiff Clay without Free Water

Soil Layer Number = 7
 Depth below pile head = 720.000 in
 Depth below ground surface = 720.000 in
 Equivalent Depth = 469.460 in
 Diameter = 48.000 in
 Undrained cohesion, c = 9.59030 lbs/in**2
 Average Eff. Unit Weight = .03376 lbs/in**3
 Epsilon-50 = .00700
 Pct = 4392.845 lbs/in
 Pcd = 4143.010 lbs/in
 Pu = 4143.010 lbs/in
 y50 = .840 in
 p-multiplier = 1.00000
 y-multiplier = 1.00000
 Number of cycles of loading = 1000.

y, in p, lbs/in

48 inch pipe - stratum 5 through 7

0.0000	0.0000
.0001344	180.1053
.0006720	269.3202
.0013440	320.2775
.0067200	478.9266
.0134400	569.5429
.0672000	851.6653
.1344000	1012.8064
.3360000	1273.5366
.6720000	1514.4988
1.0080	1676.0684
1.3440	1801.0527
3.3600	2264.7039
6.7200	2693.2020
13.4400	3202.7750
30.2400	3922.5823
47.0400	4143.0096

p-y Curve Computed Using Cyclic Criteria for Stiff Clay without Free Water

Soil Layer Number	=	7
Depth below pile head	=	816.000 in
Depth below ground surface	=	816.000 in
Equivalent Depth	=	565.460 in
Diameter	=	48.000 in
Undrained cohesion, c	=	9.59030 lbs/in**2
Average Eff. Unit Weight	=	.03396 lbs/in**3
Epsilon-50	=	.00700
Pct	=	5014.299 lbs/in
Pcd	=	4143.010 lbs/in
Pu	=	4143.010 lbs/in
y50	=	.840 in
p-multiplier	=	1.00000
y-multiplier	=	1.00000
Number of cycles of loading	=	1000.

y, in	p, lbs/in
0.0000	0.0000
.0001344	180.1053
.0006720	269.3202
.0013440	320.2775
.0067200	478.9266
.0134400	569.5429
.0672000	851.6653
.1344000	1012.8064
.3360000	1273.5366
.6720000	1514.4988
1.0080	1676.0684
1.3440	1801.0527
3.3600	2264.7039
6.7200	2693.2020
13.4400	3202.7750
30.2400	3922.5823
47.0400	4143.0096

48 inch pipe - stratum 5 through 7
 Computed Values of Load Distribution and Deflection
 for Lateral Loading for Load Case Number 1

Pile-head boundary conditions are Shear and Moment (BC Type 1)
 Specified shear force at pile head = 1000.000 lbs
 Specified moment at pile head = 1000.000 in-lbs
 Specified axial load at pile head = 1000.000 lbs

Non-zero moment for this load case indicates the pile-head may rotate under the applied pile-head loading, but is not a free-head (zero moment) condition.

Depth Es*h X F/L in lbs/in	Deflect. y in	Moment M lbs-in	Shear V lbs	Slope S Rad.	Total Stress lbs/in**2	Soil Res. p lbs/in
0.000	.022112	1000.0000	1000.0000	-.0003760	13.4969	0.0000
0.0000						
16.900	.015776	17906.3359	874.7391	-.0003556	15.0541	-14.8238
15879.9160						
33.800	.010094	30578.1984	589.1814	-.0003031	16.2212	-18.9700
31759.8320						
50.700	.005530	37830.9132	177.1883	-.0002292	16.8892	-29.7866
91032.8473						
67.600	.002347	36574.9088	-282.8519	-.0001488	16.7735	-24.6561
177506.						
84.500	.000501	28275.5467	-579.3430	-7.8670E-05	16.0091	-10.4316
351600.						
101.400	-.000312	16995.7732	-608.1068	-2.9734E-05	14.9702	7.0276
381183.						
118.300	-.000504	7722.5407	-445.2916	-3.0151E-06	14.1161	12.2404
410766.						
135.200	-.000413	1945.0191	-250.8209	7.4349E-06	13.5840	10.7738
440349.						
152.100	-.000252	-755.4576	-100.4992	8.7208E-06	13.4744	7.0157
469932.						
169.000	-.000119	-1452.1479	-11.5644	6.3345E-06	13.5386	3.5091
499516.						
185.900	-3.82E-05	-1146.5469	20.9348	3.5255E-06	13.5104	.3369337
149071.						
202.800	4.37E-07	-744.6724	23.7458	1.4812E-06	13.4734	-.0042694
164950.						
219.700	1.19E-05	-343.9900	19.3207	3.0439E-07	13.4365	-.5194071
739783.						
236.600	1.07E-05	-91.6429	10.7743	-1.6650E-07	13.4133	-.4920061
775217.						
253.500	6.24E-06	20.1856	4.0884	-2.4374E-07	13.4067	-.2992193
810650.						
270.400	2.49E-06	46.5534	.5076810	-1.7160E-07	13.4091	-.1245351
846084.						
287.300	4.38E-07	37.3510	-.8510785	-8.0903E-08	13.4083	-.0362648
1399514.						
304.200	-2.47E-07	17.7897	-.9695832	-2.1300E-08	13.4065	.0222406
1521583.						
321.100	-2.82E-07	4.5799	-.5491272	2.8805E-09	13.4052	.0275175
1649053.						
338.000	-1.50E-07	-.7708895	-.1832468	6.9977E-09	13.4049	.0157820
1782093.						
354.900	-4.55E-08	-1.6141	-.0062032	4.4197E-09	13.4050	.0051699

48 inch pipe - stratum 5 through 7

1920886.						
371.800	-2.80E-10	-.9807071	.0377686	1.6148E-09	13.4049	3.3826E-05
2045190.						
388.700	9.10E-09	-.3375964	.0282650	1.8981E-10	13.4049	-.0011585
2152606.						
405.600	6.14E-09	-.0253560	.0115355	-2.0252E-10	13.4048	-.0008213
2262088.						
422.500	2.25E-09	.0523093	.0019246	-1.7339E-10	13.4048	-.0003161
2373749.						
439.400	2.76E-10	.0397011	-.0010890	-7.3927E-11	13.4048	-4.0571E-05
2487708.						
456.300	-2.49E-10	.0155040	-.0011083	-1.4254E-11	13.4048	3.8292E-05
2604096.						
473.200	-2.06E-10	.0022427	-.0005040	4.9289E-12	13.4048	3.3221E-05
2723054.						
490.100	-8.19E-11	-.0015305	-.0001068	5.6987E-12	13.4048	1.3787E-05
2844737.						
507.000	-1.36E-11	-.0013659	2.9873E-05	2.5679E-12	13.4048	2.3821E-06
2969314.						
523.900	4.89E-12	-.0005209	3.8546E-05	5.2843E-13	13.4048	-1.3558E-06
4687590.						
540.800	4.30E-12	-6.3065E-05	1.6680E-05	-1.0277E-13	13.4048	-1.2319E-06
4838088.						
557.700	1.41E-12	4.2907E-05	2.7427E-06	-1.2456E-13	13.4048	-4.1747E-07
4988676.						
574.600	9.30E-14	2.9643E-05	-1.0239E-06	-4.6138E-14	13.4048	-2.8283E-08
5139347.						
591.500	-1.45E-13	8.3002E-06	-8.7881E-07	-5.1238E-15	13.4048	4.5456E-08
5290093.						
608.400	-8.02E-14	-6.0449E-08	-2.8060E-07	3.7828E-15	13.4048	2.5339E-08
5340698.						
625.300	-1.74E-14	-1.1841E-06	-1.3393E-08	2.4375E-15	13.4048	6.2833E-09
6118404.						
642.200	2.21E-15	-5.1323E-07	3.2755E-08	6.0275E-16	13.4048	-8.2196E-10
6295134.						
659.100	3.02E-15	-7.7053E-08	1.6045E-08	-3.5310E-17	13.4048	-1.1556E-09
6471916.						
676.000	1.01E-15	2.9087E-08	2.9122E-09	-8.7159E-17	13.4048	-3.9860E-10
6648748.						
692.900	7.15E-17	2.1382E-08	-6.9576E-10	-3.2605E-17	13.4048	-2.8381E-11
6705010.						
709.800	-8.89E-17	5.5711E-09	-6.3761E-10	-3.4699E-18	13.4048	3.5262E-11
6705010.						
726.700	-4.57E-17	-1.6896E-10	-1.8627E-10	2.3694E-18	13.4048	1.8151E-11
6705010.						
743.600	-8.79E-18	-7.2503E-10	-3.4274E-12	1.4031E-18	13.4048	3.4880E-12
6705010.						
760.500	1.68E-18	-2.8485E-10	2.0427E-11	3.1149E-19	13.4048	-6.6503E-13
6705010.						
777.400	1.74E-18	-3.4606E-11	8.9852E-12	-3.3828E-20	13.4048	-6.8902E-13
6705010.						
794.300	5.33E-19	1.8849E-11	1.3767E-12	-5.0861E-20	13.4048	-2.1139E-13
6705010.						
811.200	1.76E-20	1.1929E-11	-4.6845E-13	-1.7592E-20	13.4048	-6.9761E-15
6705010.						
828.100	-6.18E-20	3.0160E-12	-3.5784E-13	-1.4376E-21	13.4048	2.0065E-14
5486330.						
845.000	-3.10E-20	-1.6619E-13	-1.0323E-13	1.6428E-21	13.4048	1.0067E-14
5486330.						
861.900	-6.28E-21	-4.7326E-13	-9.3786E-16	9.5162E-22	13.4048	2.0391E-15
5486330.						
878.800	1.16E-21	-1.9792E-13	1.3122E-14	2.2612E-22	13.4048	-3.7523E-16
5486330.						

48 inch pipe - stratum 5 through 7

895.700	1.36E-21	-2.9749E-14	6.2160E-15	-1.9982E-23	13.4048	-4.4202E-16
5486330.						
912.600	4.80E-22	1.2179E-14	1.1630E-15	-3.8974E-23	13.4048	-1.5597E-16
5486330.						
929.500	4.43E-23	9.5623E-15	-2.7632E-16	-1.5473E-23	13.4048	-1.4370E-17
5486330.						
946.400	-4.25E-23	2.8406E-15	-2.8104E-16	-2.0660E-24	13.4048	1.3811E-17
5486330.						
963.300	-2.56E-23	6.3153E-17	-9.4209E-17	1.0727E-24	13.4048	8.2999E-18
5486330.						
980.200	-6.28E-24	-3.4373E-16	-6.8350E-18	7.6942E-25	13.4048	2.0402E-18
5486330.						
997.100	4.40E-25	-1.6790E-16	9.1986E-18	2.1639E-25	13.4048	-1.4270E-19
5486330.						
1014.	1.03E-24	-3.2819E-17	5.1689E-18	0.0000	13.4048	-3.3420E-19
5486330.						
1031.	4.20E-25	6.8110E-18	1.1920E-18	0.0000	13.4048	-1.3644E-19
5486330.						
1048.	0.000	7.4726E-18	-1.2533E-19	0.0000	13.4048	-1.9462E-20
5486330.						
1065.	0.000	2.5753E-18	-2.1474E-19	0.0000	13.4048	8.8812E-21
5486330.						
1082.	0.000	2.1442E-19	-8.3252E-20	0.0000	13.4048	6.6798E-21
5486330.						
1099.	0.000	-2.3865E-19	-1.0455E-20	0.0000	13.4048	1.9353E-21
5486330.						
1115.	0.000	-1.3897E-19	6.0790E-21	0.0000	13.4048	2.1363E-23
5486330.						
1132.	0.000	-3.3188E-20	4.1957E-21	0.0000	13.4048	-2.4424E-22
5486330.						
1149.	0.000	2.8413E-21	1.1499E-21	0.0000	13.4048	-1.1621E-22
5486330.						
1166.	0.000	5.6800E-21	-1.6927E-23	0.0000	13.4048	-2.1879E-23
5486330.						
1183.	0.000	2.2696E-21	-1.5885E-22	0.0000	13.4048	5.0827E-24
5486330.						
1200.	0.000	3.1077E-22	-7.2596E-23	0.0000	13.4048	5.1253E-24
5486330.						
1217.	0.000	-1.8420E-22	-1.2387E-23	0.0000	13.4048	2.0000E-24
7404154.						
1234.	0.000	-1.0794E-22	4.7795E-24	0.0000	13.4048	0.0000
7404154.						
1251.	0.000	-2.2661E-23	3.2799E-24	0.0000	13.4048	-2.0903E-25
7404154.						
1268.	0.000	2.9191E-24	7.7919E-25	0.0000	13.4048	0.0000
7404154.						
1284.	0.000	3.6761E-24	0.0000	0.0000	13.4048	0.0000
7404154.						
1301.	0.000	1.1434E-24	-1.0732E-25	0.0000	13.4048	0.0000
7404154.						
1318.	0.000	0.0000	0.0000	0.0000	13.4048	0.0000
7404154.						
1335.	0.000	-1.0761E-25	0.0000	0.0000	13.4048	0.0000
7404154.						
1352.	0.000	0.0000	0.0000	0.0000	13.4048	0.0000
7404154.						
1369.	0.000	0.0000	0.0000	0.0000	13.4048	0.0000
1.0911E+07						
1386.	0.000	0.0000	0.0000	0.0000	13.4048	0.0000
1.0911E+07						
1403.	0.000	0.0000	0.0000	0.0000	13.4048	0.0000
1.0911E+07						
1420.	0.000	0.0000	0.0000	0.0000	13.4048	0.0000

48 inch pipe - stratum 5 through 7

1.0911E+07						
1436.	0.000	0.0000	0.0000	0.0000	13.4048	0.0000
1.0911E+07						
1453.	0.000	0.0000	0.0000	0.0000	13.4048	0.0000
1.0911E+07						
1470.	0.000	0.0000	0.0000	0.0000	13.4048	0.0000
1.0911E+07						
1487.	0.000	0.0000	0.0000	0.0000	13.4048	0.0000
1.0911E+07						
1504.	0.000	0.0000	0.0000	0.0000	13.4048	0.0000
1.0911E+07						
1521.	0.000	0.0000	0.0000	0.0000	13.4048	0.0000
1.0911E+07						
1538.	0.000	0.0000	0.0000	0.0000	13.4048	0.0000
1.0911E+07						
1555.	0.000	0.0000	0.0000	0.0000	13.4048	0.0000
1.0911E+07						
1572.	0.000	0.0000	0.0000	0.0000	13.4048	0.0000
1.0911E+07						
1589.	0.000	0.0000	0.0000	0.0000	13.4048	0.0000
1.0911E+07						
1605.	0.000	0.0000	0.0000	0.0000	13.4048	0.0000
1.0911E+07						
1622.	0.000	0.0000	0.0000	0.0000	13.4048	0.0000
1.0911E+07						
1639.	0.000	0.0000	0.0000	0.0000	13.4048	0.0000
1.0911E+07						
1656.	0.000	0.0000	0.0000	0.0000	13.4048	0.0000
1.0911E+07						
1673.	0.000	0.0000	0.0000	0.0000	13.4048	0.0000
1.0911E+07						
1690.	0.000	0.0000	0.0000	0.0000	13.4048	0.0000
5455523.						

Output Verification:

Computed forces and moments are within specified convergence limits.

Output Summary for Load Case No. 1:

Pile-head deflection = .02211195 in
 Computed slope at pile head = -.00037599
 Maximum bending moment = 37830.91317 lbs-in
 Maximum shear force = 1000.00000 lbs
 Depth of maximum bending moment = 50.70000000 in
 Depth of maximum shear force = 0.00000 in
 Number of iterations = 9
 Number of zero deflection points = 26

 Summary of Pile Response(s)

Definition of Symbols for Pile-Head Loading Conditions:

Type 1 = Shear and Moment, y = pile-head displacement in
 Type 2 = Shear and Slope, M = Pile-head Moment lbs-in
 Type 3 = Shear and Rot. Stiffness, V = Pile-head Shear Force lbs

48 inch pipe - stratum 5 through 7

Type 4 = Deflection and Moment, S = Pile-head Slope, radians
Type 5 = Deflection and Slope, R = Rot. Stiffness of Pile-head in-lbs/rad

Load Type	Pile-Head Condition 1	Pile-Head Condition 2	Axial Load lbs	Pile-Head Deflection in	Maximum Moment in-lbs	Maximum Shear lbs
1	V= 1000.000	M= 1000.000	1000.0000	.0221119	37830.9132	1000.0000

The analysis ended normally.

48 inch pipe - stratum 8 through 10

LPILE Plus for Windows, Version 5.0 (5.0.30)

Analysis of Individual Piles and Drilled Shafts
Subjected to Lateral Loading Using the p-y Method

(c) 1985-2007 by Ensoft, Inc.
All Rights Reserved

This program is licensed to:

DJI
Eustis

Path to file locations: U:\sys\WPDATA\Projects\20749\Piles\LPile\
Name of input data file: 48 inch pipe - stratum 8 through 10.lpd
Name of output file: 48 inch pipe - stratum 8 through 10.lpo
Name of plot output file: 48 inch pipe - stratum 8 through 10.lpp
Name of runtime file: 48 inch pipe - stratum 8 through 10.lpr

Time and Date of Analysis

Date: November 9, 2009 Time: 15:45:17

Problem Title

EE20749 - St. Mary Floodgate Structure at Franklin Drainage Canal

Program Options

Units Used in Computations - US Customary Units: Inches, Pounds

Basic Program Options:

Analysis Type 1:

- Computation of Lateral Pile Response Using User-specified Constant EI

Computation Options:

- Only internally-generated p-y curves used in analysis
- Analysis does not use p-y multipliers (individual pile or shaft action only)
- Analysis assumes no shear resistance at pile tip
- Analysis for fixed-length pile or shaft only
- No computation of foundation stiffness matrix elements
- Output pile response for full length of pile
- Analysis assumes no soil movements acting on pile
- Additional p-y curves computed at specified depths

Solution Control Parameters:

- Number of pile increments = 100
- Maximum number of iterations allowed = 100

48 inch pipe - stratum 8 through 10

- Deflection tolerance for convergence = 1.0000E-05 in
- Maximum allowable deflection = 1.0000E+02 in

Printing Options:

- Values of pile-head deflection, bending moment, shear force, and soil reaction are printed for full length of pile.
- Printing Increment (spacing of output points) = 1

 Pile Structural Properties and Geometry

Pile Length = 1690.00 in
 Depth of ground surface below top of pile = .00 in
 Slope angle of ground surface = .00 deg.

Structural properties of pile defined using 2 points

Point	Depth X in	Pile Diameter in	Moment of Inertia in**4	Pile Area Sq.in	Modulus of Elasticity lbs/Sq.in
1	0.0000	48.00000000	260576.3000	74.6000	30000.00000
2	1690.0000	48.00000000	260576.3000	74.6000	30000.00000

 Soil and Rock Layering Information

The soil profile is modelled using 10 layers

Layer 1 is silt with cohesion and friction
 Distance from top of pile to top of layer = .000 in
 Distance from top of pile to bottom of layer = 36.000 in
 p-y subgrade modulus k for top of soil layer = 55.600 lbs/in**3
 p-y subgrade modulus k for bottom of layer = 55.600 lbs/in**3

Layer 2 is soft clay, p-y criteria by Matlock, 1970
 Distance from top of pile to top of layer = 36.000 in
 Distance from top of pile to bottom of layer = 180.000 in

Layer 3 is silt with cohesion and friction
 Distance from top of pile to top of layer = 180.000 in
 Distance from top of pile to bottom of layer = 204.000 in
 p-y subgrade modulus k for top of soil layer = 55.600 lbs/in**3
 p-y subgrade modulus k for bottom of layer = 55.600 lbs/in**3

Layer 4 is soft clay, p-y criteria by Matlock, 1970
 Distance from top of pile to top of layer = 204.000 in
 Distance from top of pile to bottom of layer = 276.000 in

Layer 5 is soft clay, p-y criteria by Matlock, 1970
 Distance from top of pile to top of layer = 276.000 in
 Distance from top of pile to bottom of layer = 516.000 in

Layer 6 is stiff clay without free water
 Distance from top of pile to top of layer = 516.000 in
 Distance from top of pile to bottom of layer = 612.000 in

Layer 7 is stiff clay without free water
 Distance from top of pile to top of layer = 612.000 in

48 inch pipe - stratum 8 through 10
 Distance from top of pile to bottom of layer = 828.000 in

Layer 8 is stiff clay without free water
 Distance from top of pile to top of layer = 828.000 in
 Distance from top of pile to bottom of layer = 1212.000 in

Layer 9 is stiff clay without free water
 Distance from top of pile to top of layer = 1212.000 in
 Distance from top of pile to bottom of layer = 1356.000 in

Layer 10 is stiff clay without free water
 Distance from top of pile to top of layer = 1356.000 in
 Distance from top of pile to bottom of layer = 1692.000 in

(Depth of lowest layer extends 2.00 in below pile tip)

 Effective Unit Weight of Soil vs. Depth

Distribution of effective unit weight of soil with depth
 is defined using 20 points

Point No.	Depth X in	Eff. Unit Weight lbs/in**3
1	.00	.03160
2	36.00	.03160
3	36.00	.03330
4	180.00	.03330
5	180.00	.03160
6	204.00	.03160
7	204.00	.03480
8	276.00	.03480
9	276.00	.03250
10	516.00	.03250
11	516.00	.03620
12	612.00	.03620
13	612.00	.03550
14	828.00	.03550
15	828.00	.03110
16	1212.00	.03110
17	1212.00	.03040
18	1356.00	.03040
19	1356.00	.03450
20	1692.00	.03450

 Shear Strength of Soils

Distribution of shear strength parameters with depth
 defined using 20 points

Point No.	Depth X in	Cohesion c lbs/in**2	Angle of Friction Deg.	E50 or k _{rm}	RQD %
1	.000	1.38890	15.00	.02000	.0
2	36.000	1.38890	15.00	.02000	.0

48 inch pipe - stratum 8 through 10					
3	36.000	2.20140	.00	.02000	.0
4	180.000	2.20140	.00	.02000	.0
5	180.000	1.38890	15.00	.02000	.0
6	204.000	1.38890	15.00	.02000	.0
7	204.000	3.12500	.00	.02000	.0
8	276.000	3.12500	.00	.02000	.0
9	276.000	4.16670	.00	.01000	.0
10	516.000	7.63890	.00	.00700	.0
11	516.000	7.63890	.00	.00700	.0
12	612.000	7.63890	.00	.00700	.0
13	612.000	9.59030	.00	.00700	.0
14	828.000	9.59030	.00	.00700	.0
15	828.000	7.84720	.00	.00700	.0
16	1212.000	7.84720	.00	.00700	.0
17	1212.000	10.59030	.00	.00700	.0
18	1356.000	10.59030	.00	.00700	.0
19	1356.000	14.34720	.00	.00500	.0
20	1692.000	14.34720	.00	.00500	.0

Notes:

- (1) Cohesion = uniaxial compressive strength for rock materials.
- (2) Values of E50 are reported for clay strata.
- (3) Default values will be generated for E50 when input values are 0.
- (4) RQD and k_{rm} are reported only for weak rock strata.

Loading Type

Cyclic loading criteria was used for computation of p-y curves

Number of cycles of loading = 1000.

Pile-head Loading and Pile-head Fixity Conditions

Number of loads specified = 1

Load Case Number 1

Pile-head boundary conditions are Shear and Moment (BC Type 1)

Shear force at pile head = 1000.000 lbs
Bending moment at pile head = 1000.000 in-lbs
Axial load at pile head = 1000.000 lbs

Non-zero moment at pile head for this load case indicates the pile-head may rotate under the applied pile-head loading, but is not a free-head (zero moment) condition.

Output of p-y Curves at Specified Depths

48 inch pipe - stratum 8 through 10

p-y curves are generated and printed for verification at 8 depths.

Depth No.	Depth Below Pile Head in	Depth Below Ground Surface in
1	840.000	840.000
2	1020.000	1020.000
3	1200.000	1200.000
4	1224.000	1224.000
5	1284.000	1284.000
6	1344.000	1344.000
7	1524.000	1524.000
8	1690.000	1690.000

Depth of ground surface below top of pile = .00 in

p-y Curve Computed Using Cyclic Criteria for Stiff Clay without Free Water

Soil Layer Number = 8
 Depth below pile head = 840.000 in
 Depth below ground surface = 840.000 in
 Equivalent Depth = 662.921 in
 Diameter = 48.000 in
 Undrained cohesion, c = 7.84720 lbs/in**2
 Average Eff. Unit Weight = .03394 lbs/in**3
 Epsilon-50 = .00700
 Pct = 4811.147 lbs/in
 Pcd = 3389.990 lbs/in
 Pu = 3389.990 lbs/in
 y50 = .840 in
 p-multiplier = 1.00000
 y-multiplier = 1.00000
 Number of cycles of loading = 1000.

y, in	p, lbs/in
0.0000	0.0000
.0001344	147.3700
.0006720	220.3695
.0013440	262.0650
.0067200	391.8785
.0134400	466.0247
.0672000	696.8695
.1344000	828.7222
.3360000	1042.0630
.6720000	1239.2287
1.0080	1371.4320
1.3440	1473.6996
3.3600	1853.0791
6.7200	2203.6949
13.4400	2620.6496
30.2400	3209.6272
47.0400	3389.9904

p-y Curve Computed Using Cyclic Criteria for Stiff Clay without Free Water

Soil Layer Number = 8
 Depth below pile head = 1020.000 in
 Depth below ground surface = 1020.000 in

48 inch pipe - stratum 8 through 10

Equivalent Depth = 842.921 in
 Diameter = 48.000 in
 Undrained cohesion, c = 7.84720 lbs/in**2
 Average Eff. Unit Weight = .03344 lbs/in**3
 Epsilon-50 = .00700
 Pct = 5790.366 lbs/in
 Pcd = 3389.990 lbs/in
 Pu = 3389.990 lbs/in
 y50 = .840 in
 p-multiplier = 1.00000
 y-multiplier = 1.00000
 Number of cycles of loading = 1000.

y, in	p, lbs/in
0.0000	0.0000
.0001344	147.3700
.0006720	220.3695
.0013440	262.0650
.0067200	391.8785
.0134400	466.0247
.0672000	696.8695
.1344000	828.7222
.3360000	1042.0630
.6720000	1239.2287
1.0080	1371.4320
1.3440	1473.6996
3.3600	1853.0791
6.7200	2203.6949
13.4400	2620.6496
30.2400	3209.6272
47.0400	3389.9904

p-y Curve Computed Using Cyclic Criteria for Stiff Clay without Free Water

Soil Layer Number = 8
 Depth below pile head = 1200.000 in
 Depth below ground surface = 1200.000 in
 Equivalent Depth = 1022.921 in
 Diameter = 48.000 in
 Undrained cohesion, c = 7.84720 lbs/in**2
 Average Eff. Unit Weight = .03309 lbs/in**3
 Epsilon-50 = .00700
 Pct = 6768.304 lbs/in
 Pcd = 3389.990 lbs/in
 Pu = 3389.990 lbs/in
 y50 = .840 in
 p-multiplier = 1.00000
 y-multiplier = 1.00000
 Number of cycles of loading = 1000.

y, in	p, lbs/in
0.0000	0.0000
.0001344	147.3700
.0006720	220.3695
.0013440	262.0650
.0067200	391.8785
.0134400	466.0247
.0672000	696.8695
.1344000	828.7222
.3360000	1042.0630

	48 inch pipe - stratum 8 through 10
.6720000	1239.2287
1.0080	1371.4320
1.3440	1473.6996
3.3600	1853.0791
6.7200	2203.6949
13.4400	2620.6496
30.2400	3209.6272
47.0400	3389.9904

p-y Curve Computed Using Cyclic Criteria for Stiff Clay without Free Water

Soil Layer Number	=	9
Depth below pile head	=	1224.000 in
Depth below ground surface	=	1224.000 in
Equivalent Depth	=	826.020 in
Diameter	=	48.000 in
Undrained cohesion, c	=	10.59030 lbs/in**2
Average Eff. Unit Weight	=	.03305 lbs/in**3
Epsilon-50	=	.00700
Pct	=	7209.108 lbs/in
Pcd	=	4575.010 lbs/in
Pu	=	4575.010 lbs/in
y50	=	.840 in
p-multiplier	=	1.00000
y-multiplier	=	1.00000
Number of cycles of loading	=	1000.

y, in	p, lbs/in
0.0000	0.0000
.0001344	198.8852
.0006720	297.4028
.0013440	353.6735
.0067200	528.8652
.0134400	628.9303
.0672000	940.4701
.1344000	1118.4137
.3360000	1406.3308
.6720000	1672.4186
1.0080	1850.8355
1.3440	1988.8522
3.3600	2500.8492
6.7200	2974.0276
13.4400	3536.7348
30.2400	4331.5979
47.0400	4575.0096

p-y Curve Computed Using Cyclic Criteria for Stiff Clay without Free Water

Soil Layer Number	=	9
Depth below pile head	=	1284.000 in
Depth below ground surface	=	1284.000 in
Equivalent Depth	=	886.020 in
Diameter	=	48.000 in
Undrained cohesion, c	=	10.59030 lbs/in**2
Average Eff. Unit Weight	=	.03292 lbs/in**3
Epsilon-50	=	.00700
Pct	=	7616.730 lbs/in

48 inch pipe - stratum 8 through 10

Pcd = 4575.010 lbs/in
 Pu = 4575.010 lbs/in
 y50 = .840 in
 p-multiplier = 1.00000
 y-multiplier = 1.00000
 Number of cycles of loading = 1000.

y, in	p, lbs/in
0.0000	0.0000
.0001344	198.8852
.0006720	297.4028
.0013440	353.6735
.0067200	528.8652
.0134400	628.9303
.0672000	940.4701
.1344000	1118.4137
.3360000	1406.3308
.6720000	1672.4186
1.0080	1850.8355
1.3440	1988.8522
3.3600	2500.8492
6.7200	2974.0276
13.4400	3536.7348
30.2400	4331.5979
47.0400	4575.0096

p-y Curve Computed Using Cyclic Criteria for Stiff Clay without Free Water

Soil Layer Number = 9
 Depth below pile head = 1344.000 in
 Depth below ground surface = 1344.000 in
 Equivalent Depth = 946.020 in
 Diameter = 48.000 in
 Undrained cohesion, c = 10.59030 lbs/in**2
 Average Eff. Unit Weight = .03281 lbs/in**3
 Epsilon-50 = .00700
 Pct = 8024.141 lbs/in
 Pcd = 4575.010 lbs/in
 Pu = 4575.010 lbs/in
 y50 = .840 in
 p-multiplier = 1.00000
 y-multiplier = 1.00000
 Number of cycles of loading = 1000.

y, in	p, lbs/in
0.0000	0.0000
.0001344	198.8852
.0006720	297.4028
.0013440	353.6735
.0067200	528.8652
.0134400	628.9303
.0672000	940.4701
.1344000	1118.4137
.3360000	1406.3308
.6720000	1672.4186
1.0080	1850.8355
1.3440	1988.8522
3.3600	2500.8492
6.7200	2974.0276
13.4400	3536.7348

30.2400 48 inch pipe - stratum 8 through 10
 47.0400 4331.5979
 4575.0096

p-y Curve Computed Using Cyclic Criteria for Stiff Clay without Free Water

Soil Layer Number = 10
 Depth below pile head = 1524.000 in
 Depth below ground surface = 1524.000 in
 Equivalent Depth = 920.012 in
 Diameter = 48.000 in
 Undrained cohesion, c = 14.34720 lbs/in**2
 Average Eff. Unit Weight = .03298 lbs/in**3
 Epsilon-50 = .00500
 Pct = 10122.049 lbs/in
 Pcd = 6197.990 lbs/in
 Pu = 6197.990 lbs/in
 y50 = .600 in
 p-multiplier = 1.00000
 y-multiplier = 1.00000
 Number of cycles of loading = 1000.

y, in	p, lbs/in
0.0000	0.0000
9.6000E-05	269.4396
.0004800	402.9061
.0009600	479.1388
.0048000	716.4797
.0096000	852.0428
.0480000	1274.1011
.0960000	1515.1701
.2400000	1905.2255
.4800000	2265.7078
.7200000	2507.4178
.9600000	2694.3958
2.4000	3388.0233
4.8000	4029.0614
9.6000	4791.3885
21.6000	5868.2286
33.6000	6197.9904

p-y Curve Computed Using Cyclic Criteria for Stiff Clay without Free Water

Soil Layer Number = 10
 Depth below pile head = 1690.000 in
 Depth below ground surface = 1690.000 in
 Equivalent Depth = 1086.012 in
 Diameter = 48.000 in
 Undrained cohesion, c = 14.34720 lbs/in**2
 Average Eff. Unit Weight = .03313 lbs/in**3
 Epsilon-50 = .00500
 Pct = 11583.424 lbs/in
 Pcd = 6197.990 lbs/in
 Pu = 6197.990 lbs/in
 y50 = .600 in
 p-multiplier = 1.00000
 y-multiplier = 1.00000
 Number of cycles of loading = 1000.

48 inch pipe - stratum 8 through 10

y, in	p, lbs/in
0.0000	0.0000
9.6000E-05	269.4396
.0004800	402.9061
.0009600	479.1388
.0048000	716.4797
.0096000	852.0428
.0480000	1274.1011
.0960000	1515.1701
.2400000	1905.2255
.4800000	2265.7078
.7200000	2507.4178
.9600000	2694.3958
2.4000	3388.0233
4.8000	4029.0614
9.6000	4791.3885
21.6000	5868.2286
33.6000	6197.9904

 Computed Values of Load Distribution and Deflection
 for Lateral Loading for Load Case Number 1

Pile-head boundary conditions are Shear and Moment (BC Type 1)
 Specified shear force at pile head = 1000.000 lbs
 Specified moment at pile head = 1000.000 in-lbs
 Specified axial load at pile head = 1000.000 lbs

Non-zero moment for this load case indicates the pile-head may rotate under the applied pile-head loading, but is not a free-head (zero moment) condition.

Depth Es*h	Deflect. y	Moment M	Shear V	Slope S	Total Stress	Soil Res. p
F/L in lbs/in	in	lbs-in	lbs	Rad.	lbs/in**2	lbs/in
0.000	.022112	1000.0000	1000.0000	-.0003760	13.4969	0.0000
0.0000						
16.900	.015776	17906.3359	874.7391	-.0003556	15.0541	-14.8238
15879.9160						
33.800	.010094	30578.1984	589.1814	-.0003031	16.2212	-18.9700
31759.8320						
50.700	.005530	37830.9132	177.1883	-.0002292	16.8892	-29.7866
91032.8473						
67.600	.002347	36574.9088	-282.8519	-.0001488	16.7735	-24.6561
177506.						
84.500	.000501	28275.5467	-579.3430	-7.8670E-05	16.0091	-10.4316
351600.						
101.400	-.000312	16995.7732	-608.1068	-2.9734E-05	14.9702	7.0276
381183.						
118.300	-.000504	7722.5407	-445.2916	-3.0151E-06	14.1161	12.2404
410766.						
135.200	-.000413	1945.0191	-250.8209	7.4349E-06	13.5840	10.7738

48 inch pipe - stratum 8 through 10

440349.						
152.100	-.000252	-755.4576	-100.4992	8.7208E-06	13.4744	7.0157
469932.						
169.000	-.000119	-1452.1479	-11.5644	6.3345E-06	13.5386	3.5091
499516.						
185.900	-3.82E-05	-1146.5469	20.9348	3.5255E-06	13.5104	.3369337
149071.						
202.800	4.37E-07	-744.6724	23.7458	1.4812E-06	13.4734	-.0042694
164950.						
219.700	1.19E-05	-343.9900	19.3207	3.0439E-07	13.4365	-.5194071
739783.						
236.600	1.07E-05	-91.6429	10.7743	-1.6650E-07	13.4133	-.4920061
775217.						
253.500	6.24E-06	20.1856	4.0884	-2.4374E-07	13.4067	-.2992193
810650.						
270.400	2.49E-06	46.5534	.5076810	-1.7160E-07	13.4091	-.1245351
846084.						
287.300	4.38E-07	37.3510	-.8510785	-8.0903E-08	13.4083	-.0362648
1399514.						
304.200	-2.47E-07	17.7897	-.9695832	-2.1300E-08	13.4065	.0222406
1521583.						
321.100	-2.82E-07	4.5799	-.5491272	2.8805E-09	13.4052	.0275175
1649053.						
338.000	-1.50E-07	-.7708895	-.1832468	6.9977E-09	13.4049	.0157820
1782093.						
354.900	-4.55E-08	-1.6141	-.0062032	4.4197E-09	13.4050	.0051699
1920886.						
371.800	-2.80E-10	-.9807071	.0377686	1.6148E-09	13.4049	3.3826E-05
2045190.						
388.700	9.10E-09	-.3375964	.0282650	1.8981E-10	13.4049	-.0011585
2152606.						
405.600	6.14E-09	-.0253560	.0115355	-2.0252E-10	13.4048	-.0008213
2262088.						
422.500	2.25E-09	.0523093	.0019246	-1.7339E-10	13.4048	-.0003161
2373749.						
439.400	2.76E-10	.0397011	-.0010890	-7.3927E-11	13.4048	-4.0571E-05
2487708.						
456.300	-2.49E-10	.0155040	-.0011083	-1.4254E-11	13.4048	3.8292E-05
2604096.						
473.200	-2.06E-10	.0022427	-.0005040	4.9289E-12	13.4048	3.3221E-05
2723054.						
490.100	-8.19E-11	-.0015305	-.0001068	5.6987E-12	13.4048	1.3787E-05
2844737.						
507.000	-1.36E-11	-.0013659	2.9873E-05	2.5679E-12	13.4048	2.3821E-06
2969314.						
523.900	4.89E-12	-.0005209	3.8546E-05	5.2843E-13	13.4048	-1.3558E-06
4687590.						
540.800	4.30E-12	-6.3065E-05	1.6680E-05	-1.0277E-13	13.4048	-1.2319E-06
4838088.						
557.700	1.41E-12	4.2907E-05	2.7427E-06	-1.2456E-13	13.4048	-4.1747E-07
4988676.						
574.600	9.30E-14	2.9643E-05	-1.0239E-06	-4.6138E-14	13.4048	-2.8283E-08
5139347.						
591.500	-1.45E-13	8.3002E-06	-8.7881E-07	-5.1238E-15	13.4048	4.5456E-08
5290093.						
608.400	-8.02E-14	-6.0449E-08	-2.8060E-07	3.7828E-15	13.4048	2.5339E-08
5340698.						
625.300	-1.74E-14	-1.1841E-06	-1.3393E-08	2.4375E-15	13.4048	6.2833E-09
6118404.						
642.200	2.21E-15	-5.1323E-07	3.2755E-08	6.0275E-16	13.4048	-8.2196E-10
6295134.						
659.100	3.02E-15	-7.7053E-08	1.6045E-08	-3.5310E-17	13.4048	-1.1556E-09
6471916.						

48 inch pipe - stratum 8 through 10

676.000	1.01E-15	2.9087E-08	2.9122E-09	-8.7159E-17	13.4048	-3.9860E-10
6648748.						
692.900	7.15E-17	2.1382E-08	-6.9576E-10	-3.2605E-17	13.4048	-2.8381E-11
6705010.						
709.800	-8.89E-17	5.5711E-09	-6.3761E-10	-3.4699E-18	13.4048	3.5262E-11
6705010.						
726.700	-4.57E-17	-1.6896E-10	-1.8627E-10	2.3694E-18	13.4048	1.8151E-11
6705010.						
743.600	-8.79E-18	-7.2503E-10	-3.4274E-12	1.4031E-18	13.4048	3.4880E-12
6705010.						
760.500	1.68E-18	-2.8485E-10	2.0427E-11	3.1149E-19	13.4048	-6.6503E-13
6705010.						
777.400	1.74E-18	-3.4606E-11	8.9852E-12	-3.3828E-20	13.4048	-6.8902E-13
6705010.						
794.300	5.33E-19	1.8849E-11	1.3767E-12	-5.0861E-20	13.4048	-2.1139E-13
6705010.						
811.200	1.76E-20	1.1929E-11	-4.6845E-13	-1.7592E-20	13.4048	-6.9761E-15
6705010.						
828.100	-6.18E-20	3.0160E-12	-3.5784E-13	-1.4376E-21	13.4048	2.0065E-14
5486330.						
845.000	-3.10E-20	-1.6619E-13	-1.0323E-13	1.6428E-21	13.4048	1.0067E-14
5486330.						
861.900	-6.28E-21	-4.7326E-13	-9.3786E-16	9.5162E-22	13.4048	2.0391E-15
5486330.						
878.800	1.16E-21	-1.9792E-13	1.3122E-14	2.2612E-22	13.4048	-3.7523E-16
5486330.						
895.700	1.36E-21	-2.9749E-14	6.2160E-15	-1.9982E-23	13.4048	-4.4202E-16
5486330.						
912.600	4.80E-22	1.2179E-14	1.1630E-15	-3.8974E-23	13.4048	-1.5597E-16
5486330.						
929.500	4.43E-23	9.5623E-15	-2.7632E-16	-1.5473E-23	13.4048	-1.4370E-17
5486330.						
946.400	-4.25E-23	2.8406E-15	-2.8104E-16	-2.0660E-24	13.4048	1.3811E-17
5486330.						
963.300	-2.56E-23	6.3153E-17	-9.4209E-17	1.0727E-24	13.4048	8.2999E-18
5486330.						
980.200	-6.28E-24	-3.4373E-16	-6.8350E-18	7.6942E-25	13.4048	2.0402E-18
5486330.						
997.100	4.40E-25	-1.6790E-16	9.1986E-18	2.1639E-25	13.4048	-1.4270E-19
5486330.						
1014.	1.03E-24	-3.2819E-17	5.1689E-18	0.0000	13.4048	-3.3420E-19
5486330.						
1031.	4.20E-25	6.8110E-18	1.1920E-18	0.0000	13.4048	-1.3644E-19
5486330.						
1048.	0.000	7.4726E-18	-1.2533E-19	0.0000	13.4048	-1.9462E-20
5486330.						
1065.	0.000	2.5753E-18	-2.1474E-19	0.0000	13.4048	8.8812E-21
5486330.						
1082.	0.000	2.1442E-19	-8.3252E-20	0.0000	13.4048	6.6798E-21
5486330.						
1099.	0.000	-2.3865E-19	-1.0455E-20	0.0000	13.4048	1.9353E-21
5486330.						
1115.	0.000	-1.3897E-19	6.0790E-21	0.0000	13.4048	2.1363E-23
5486330.						
1132.	0.000	-3.3188E-20	4.1957E-21	0.0000	13.4048	-2.4424E-22
5486330.						
1149.	0.000	2.8413E-21	1.1499E-21	0.0000	13.4048	-1.1621E-22
5486330.						
1166.	0.000	5.6800E-21	-1.6927E-23	0.0000	13.4048	-2.1879E-23
5486330.						
1183.	0.000	2.2696E-21	-1.5885E-22	0.0000	13.4048	5.0827E-24
5486330.						
1200.	0.000	3.1077E-22	-7.2596E-23	0.0000	13.4048	5.1253E-24

48 inch pipe - stratum 8 through 10

5486330.						
1217.	0.000	-1.8420E-22	-1.2387E-23	0.0000	13.4048	2.0000E-24
7404154.						
1234.	0.000	-1.0794E-22	4.7795E-24	0.0000	13.4048	0.0000
7404154.						
1251.	0.000	-2.2661E-23	3.2799E-24	0.0000	13.4048	-2.0903E-25
7404154.						
1268.	0.000	2.9191E-24	7.7919E-25	0.0000	13.4048	0.0000
7404154.						
1284.	0.000	3.6761E-24	0.0000	0.0000	13.4048	0.0000
7404154.						
1301.	0.000	1.1434E-24	-1.0732E-25	0.0000	13.4048	0.0000
7404154.						
1318.	0.000	0.0000	0.0000	0.0000	13.4048	0.0000
7404154.						
1335.	0.000	-1.0761E-25	0.0000	0.0000	13.4048	0.0000
7404154.						
1352.	0.000	0.0000	0.0000	0.0000	13.4048	0.0000
7404154.						
1369.	0.000	0.0000	0.0000	0.0000	13.4048	0.0000
1.0911E+07						
1386.	0.000	0.0000	0.0000	0.0000	13.4048	0.0000
1.0911E+07						
1403.	0.000	0.0000	0.0000	0.0000	13.4048	0.0000
1.0911E+07						
1420.	0.000	0.0000	0.0000	0.0000	13.4048	0.0000
1.0911E+07						
1436.	0.000	0.0000	0.0000	0.0000	13.4048	0.0000
1.0911E+07						
1453.	0.000	0.0000	0.0000	0.0000	13.4048	0.0000
1.0911E+07						
1470.	0.000	0.0000	0.0000	0.0000	13.4048	0.0000
1.0911E+07						
1487.	0.000	0.0000	0.0000	0.0000	13.4048	0.0000
1.0911E+07						
1504.	0.000	0.0000	0.0000	0.0000	13.4048	0.0000
1.0911E+07						
1521.	0.000	0.0000	0.0000	0.0000	13.4048	0.0000
1.0911E+07						
1538.	0.000	0.0000	0.0000	0.0000	13.4048	0.0000
1.0911E+07						
1555.	0.000	0.0000	0.0000	0.0000	13.4048	0.0000
1.0911E+07						
1572.	0.000	0.0000	0.0000	0.0000	13.4048	0.0000
1.0911E+07						
1589.	0.000	0.0000	0.0000	0.0000	13.4048	0.0000
1.0911E+07						
1605.	0.000	0.0000	0.0000	0.0000	13.4048	0.0000
1.0911E+07						
1622.	0.000	0.0000	0.0000	0.0000	13.4048	0.0000
1.0911E+07						
1639.	0.000	0.0000	0.0000	0.0000	13.4048	0.0000
1.0911E+07						
1656.	0.000	0.0000	0.0000	0.0000	13.4048	0.0000
1.0911E+07						
1673.	0.000	0.0000	0.0000	0.0000	13.4048	0.0000
1.0911E+07						
1690.	0.000	0.0000	0.0000	0.0000	13.4048	0.0000
5455523.						

Output Verification:

Computed forces and moments are within specified convergence limits.

48 inch pipe - stratum 8 through 10

Output Summary for Load Case No. 1:

Pile-head deflection = .02211195 in
 Computed slope at pile head = -.00037599
 Maximum bending moment = 37830.91317 lbs-in
 Maximum shear force = 1000.00000 lbs
 Depth of maximum bending moment = 50.70000000 in
 Depth of maximum shear force = 0.00000 in
 Number of iterations = 9
 Number of zero deflection points = 26

 Summary of Pile Response(s)

Definition of Symbols for Pile-Head Loading Conditions:

Type 1 = Shear and Moment, y = pile-head displacement in
 Type 2 = Shear and Slope, M = Pile-head Moment lbs-in
 Type 3 = Shear and Rot. Stiffness, V = Pile-head Shear Force lbs
 Type 4 = Deflection and Moment, S = Pile-head Slope, radians
 Type 5 = Deflection and Slope, R = Rot. Stiffness of Pile-head in-lbs/rad

Load Type	Pile-Head Condition 1	Pile-Head Condition 2	Axial Load lbs	Pile-Head Deflection in	Maximum Moment in-lbs	Maximum Shear lbs
1	V= 1000.000	M= 1000.000	1000.0000	.0221119	37830.9132	1000.0000

The analysis ended normally.

18-IN. SQUARE, PRECAST CONCRETE PILES

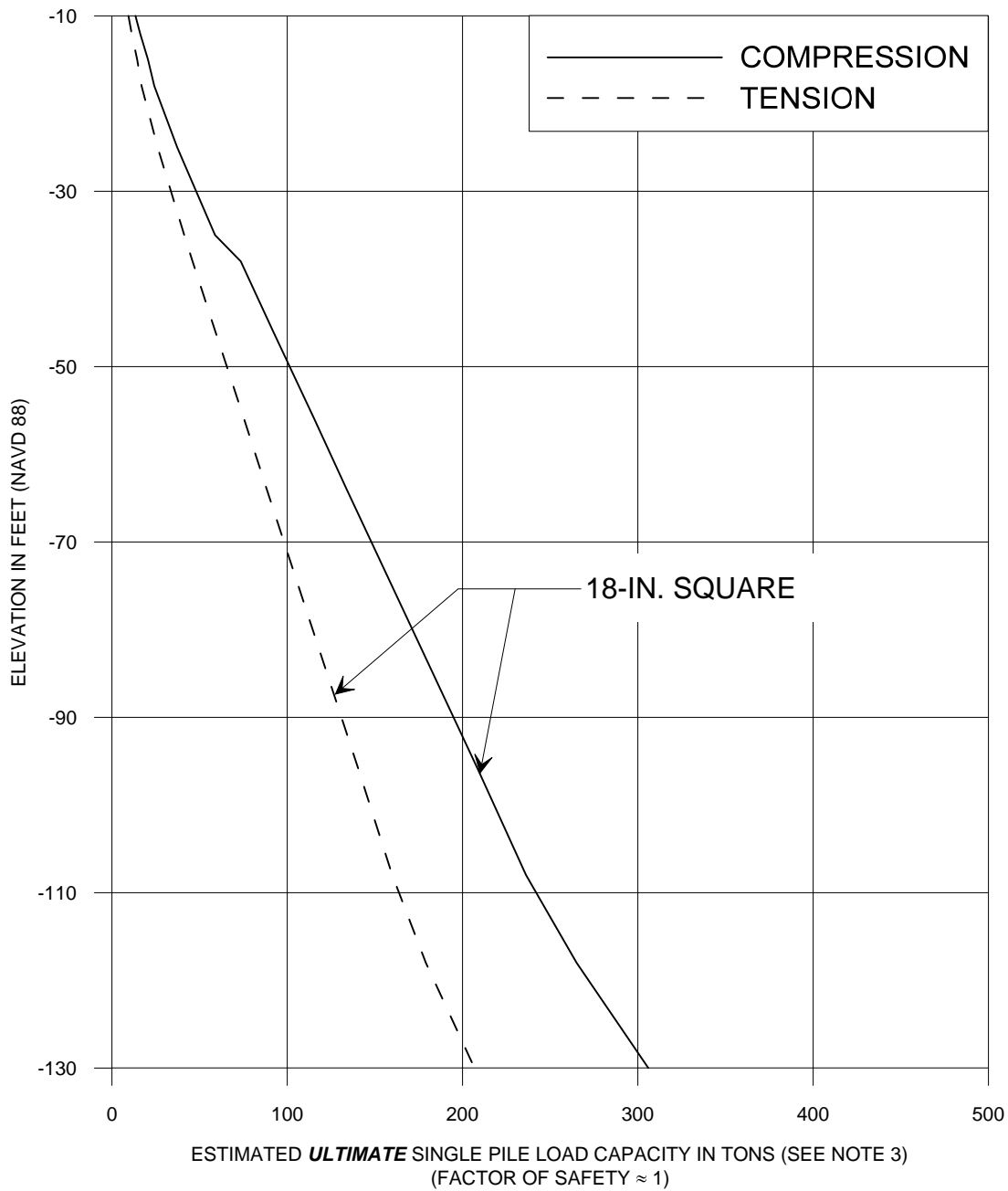

NOTES:

- 1) PILES ARE ASSUMED TO BE INSTALLED BY IMPACT DRIVING EQUIPMENT WITHOUT ASSISTANCE FROM JETTING, PREDRILLING, OR VIBRATORY EQUIPMENT.
- 2) THE PILE CAPACITIES DO NOT INCLUDE THE WEIGHT OF THE PILE.
- 3) A FACTOR OF SAFETY EQUAL TO 2 MAY BE USED IF STATIC PILE LOAD TESTING IS PERFORMED, AND A FACTOR OF SAFETY EQUAL TO 3 SHOULD BE USED IF STATIC TESTING IS NOT PERFORMED.



EUSTIS ENGINEERING SERVICES, L.L.C.
 GEOTECHNICAL ENGINEERS
 3011 28TH STREET METAIRIE, LOUISIANA

ESTIMATED **ULTIMATE** SINGLE PILE LOAD CAPACITIES
 18-IN. SQUARE, PRECAST CONCRETE PILES - Q-CASE

ST. MARY PARISH LEVEE DISTRICT
 FLOODGATE STRUCTURE AT FRANKLIN DRAINAGE CANAL
 ST. MARY PARISH, LOUISIANA

DRAWN BY: D.J.I.	6 NOVEMBER 2009	FILE: SPC-18in.GRF
CHECKED BY: J.J.H.	JOB NO.: 20749	

STATE OF LOUISIANA
OFFICE OF COASTAL PROTECTION AND RESTORATION
FRANKLIN CANAL DRAINAGE PUMP STATION
ST. MARY PARISH, LOUISIANA
PURCHASE ORDER NO. 827643-000 OP
EUSTIS ENGINEERING PROJECT NO. 22058

ESTIMATED **ULTIMATE** SINGLE PILE LOAD CAPACITIES

DIAMETER OF TREATED ASTM D 25 QUALITY TIMBER PILE	PILE TIP EMBEDMENT BELOW EXISTING GROUND SURFACE IN FEET	ESTIMATED ULTIMATE SINGLE PILE LOAD CAPACITIES IN TONS ⁽²⁾ FACTOR OF SAFETY ≈ 1 ⁽³⁾	
		COMPRESSION	TENSION
8-In. Tip 12-In. Butt	35	21½	14½
	40	26	17½
7-In. Tip 12-In. Butt	45	29	19½
	50	33½	23
	55	38	26
	60	43	29½

⁽¹⁾ Existing ground surface was estimated at el 5.0 (NAVD88).

⁽²⁾ These estimated capacities do not include limitations on structural capacity or imposed by some building codes.

⁽³⁾ A factor of safety of 2 may be used if a static pile load test is performed. If a static load test is not performed, a factor of safety of 3 should be used.

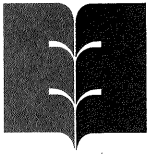

EUSTIS ENGINEERING SERVICES, L.L.C.

3011 28TH STREET
METAIRIE, LOUISIANA 70002-6019
PN 504-834-0157 | FN 504-834-0354
EMAIL: INFO@EUSTISENG.COM | SITE: WWW.EUSTISENG.COM

26 July 2013

CB&I
197 Elysian Drive
Houma, Louisiana 70363

Attention Mr. Oscar Peña, P.E.
Email oscar.pena@cbi.com

Gentlemen:

Supplemental Letter to Geotechnical Report
Results of Floodwall Stability Analyses
State of Louisiana
Coastal Protection And Restoration Authority
Franklin Drainage Canal Pump Station
St. Mary Parish, Louisiana
CB&I Purchase Order No. 827643-000 OP
Eustis Engineering Project No. 22058

Eustis Engineering Services, L.L.C., is providing this letter to supplement our geotechnical report entitled "Geotechnical Investigation, St. Mary Parish Levee District, Floodgate Structure At Franklin Drainage Canal, St. Mary Parish, Louisiana, Eustis Engineering Project No. 20749" dated 20 January 2010 for the Floodgate Structure at Franklin Drainage Canal in St. Mary Parish, Louisiana. This letter has been prepared in response to a review comment made by the Coastal Protection and Restoration Authority (CPRA). Specifically, they have requested deep-seated global stability analyses of the floodwalls that span the canal and also at the proposed pump station location.

Background and Furnished Information. We are in receipt of CPRA's comments, dated 11 July 2013, from their 95% review of the project documents for the subject project. Comment No. 34 from CPRA's review reads "No stability analysis performed for the wall or PS Fronting Protection." As stated in our 20 January 2010 report, Eustis Engineering did not previously evaluate deep-seated global stability of the flood wall, as we understood the wall design was being performed by CB&I (formerly Shaw Coastal, Inc.). However, this letter provides the results of deep-seated global stability analyses as requested by CPRA.

CB&I
26 July 2013

The deep-seated stability analyses of the floodwall provided in this letter are based on the furnished mudline and tip elevations shown in the construction drawings. We specifically referenced sheet 47 of 59 which is entitled "Sheet Pile Flood Wall Details" dated May 2012.

The construction drawing shows a braced wall with a mudline at el -6 and sheetpile tip at el -20, and a cantilevered wall with a mudline at el 0 and sheetpile tip at el -28. We understand the project plans have already been approved for construction.

The deep-seated stability analyses of the floodwall that provides frontal protection to the proposed pump station is based on the furnished elevations and dimensions shown on Sheet S-001 entitled "Plan and Elevations" and included in the Franklin Canal Flood Protection System, Phase II-Pump Station, Project TV-52 project plans. The Phase II-Pump Station plans are dated June 2013.

Deep-Seated Global Stability Analyses of Flood Walls. Eustis Engineering has evaluated deep-seated global stability of the braced and cantilevered flood walls using Spencer's Method of Slices and SLOPE/W, Version 7.21, developed by Geo-Slope International, Ltd. Results of our deep-seated stability analyses are presented on Enclosure 1 (braced wall, mudline at el -6), Enclosure 2 (cantilever wall, mudline at el 0), and Enclosure 3 (Frontal Protection at Pump Station). The required minimum factors of safety for deep-seated global stability are provided in the Hurricane Storm and Flood Risk Reduction System (HSDRRS) design guidelines as 1.40 for flood side water at the top of wall (TOW) and 1.50 for flood side water at the still water level (SWL). The analyses presented on Enclosures 1 through 3 considered flood side water level at el 9.5 (TOW) and the protected side water at low water level (LWL) at el 1. Hydraulic criteria referenced for this letter are consistent with our 20 January 2010 geotechnical report. Note, the factors of safety computed for TOW conditions are greater than 1.50 and thus we did not need to analyze the floodwall under SWL conditions.

Based on the results of our floodwall stability analyses, the proposed flood wall system will provide factors of safety greater than those required by HSDRRS design guidelines.

The results and recommendations described in our 20 January 2010 report (Eustis Engineering Project No. 20749), not specifically addressed in this letter, remain valid. Local stability of the floodwall and pump station have not been evaluated by Eustis Engineering.

CB&I
26 July 2013

We enjoyed working with you on this important project. Please contact us if you have any questions.

Yours very truly,

EUSTIS ENGINEERING SERVICES, L.L.C.



SEAN G. WALSH, P.E.

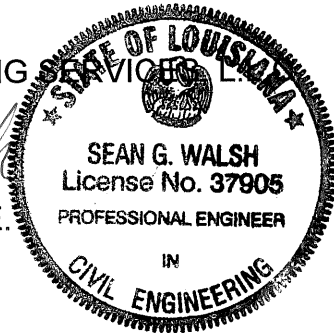

SGW:aln/jdd

Enclosure 1 through 3

Copy to:

CB&I

197 Elysian Drive

Houma, Louisiana 70363

Attention Mr. Jeff Peña, P.E.

Email jeffery.pena@cbi.com

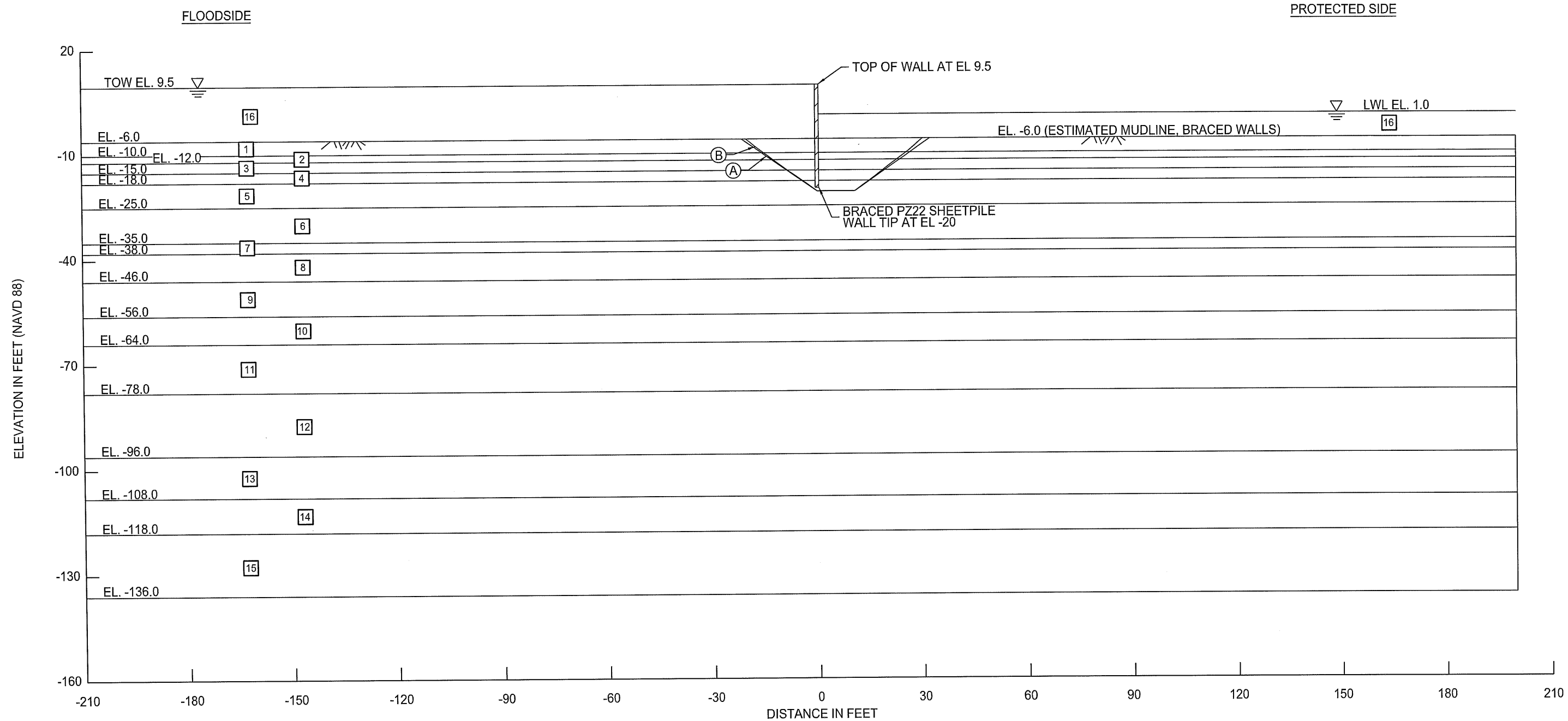

SOIL NO.	DESCRIPTION	FRICTION ANGLE IN DEGREES	UNIT WEIGHT IN PCF	COHESION IN PSF	
				AVG	BASE
1	CLAY	0	120	300	300
2	SILT	15	117	200	200
3	CLAY	0	125	500	500
4	CLAY	0	120	400	400
5	CLAY	0	112	600	775
6	CLAY	0	122	775	1025
7	CLAY	0	122	1025	1100
8	CLAY	0	125	1100	1100
9	CLAY	0	122	1325	1325
10	CLAY	0	126	1450	1450
11	CLAY	0	118	1130	1130
12	CLAY	0	115	1130	1130
13	CLAY	0	124	1825	1825
14	CLAY	0	121	2200	2200
15	CLAY	0	115	1525	1525
16	WATER	0	64	0	0

SLIP SURFACE DESIGNATION	TYPE OF SEARCH	FACTOR OF SAFETY	FILE NAME	MINIMUM REQUIRED FACTOR OF SAFETY
(A)	BLOCK SEARCH	4.78	BRACED WALL_ML_EL -6 (TOW UPPER BLOCK SPECIFIED).GSZ	1.40
(B)	FULLY SPECIFIED WITH OPTIMIZATION	4.76	BRACED WALL_ML_EL -6 (TOW FULLY SPECIFIED).GSZ	1.40

- NOTES:
- SLOPE STABILITY ANALYSIS PERFORMED USING SPENCER'S METHOD AND THE OPTIMIZATION SEARCH ROUTINE WITH SLOPE/W SOFTWARE VERSION 7.21.
 - SHEETPILE TIP ELEVATION WAS EVALUATED BASED ON CONSTRUCTION DRAWING "SHEET PILE FLOOD WALL DETAILS," SHEET 47 OF 59.
 - TOP OF WALL (TOW) AT EL 9.5 ANALYSIS GOVERN THE DESIGN SINCE THE MINIMUM FACTOR OF SAFETY FOR LOW WATER LEVEL (LWL) AND STILL WATER LEVEL (SWL) CONDITIONS HAVE BEEN EXCEEDED.

EUSTIS ENGINEERING SERVICES, L.L.C.
 GEOTECHNICAL ENGINEERS
 3011 28TH STREET METAIRIE, LOUISIANA

SLOPE STABILITY ANALYSIS
 TOP OF BRACED WALL (TOW), MUDLINE AT EL -6
 SPENCER'S METHOD

STATE OF LOUISIANA
 COASTAL PROTECTION AND RESTORATION AUTHORITY
 FRANKLIN DRAINAGE CANAL PUMP STATION
 ST. MARY PARISH, LOUISIANA
 CB&I, INC. PURCHASE ORDER NO. 827643-000 OP

DRAWN BY: J.L.S.	PLOT DATE: 25 JULY 13	CADD FILE: TOW EL 6.DGN
CHECKED BY: S.G.W.	JOB NO.: 22058	ENCLOSURE 1

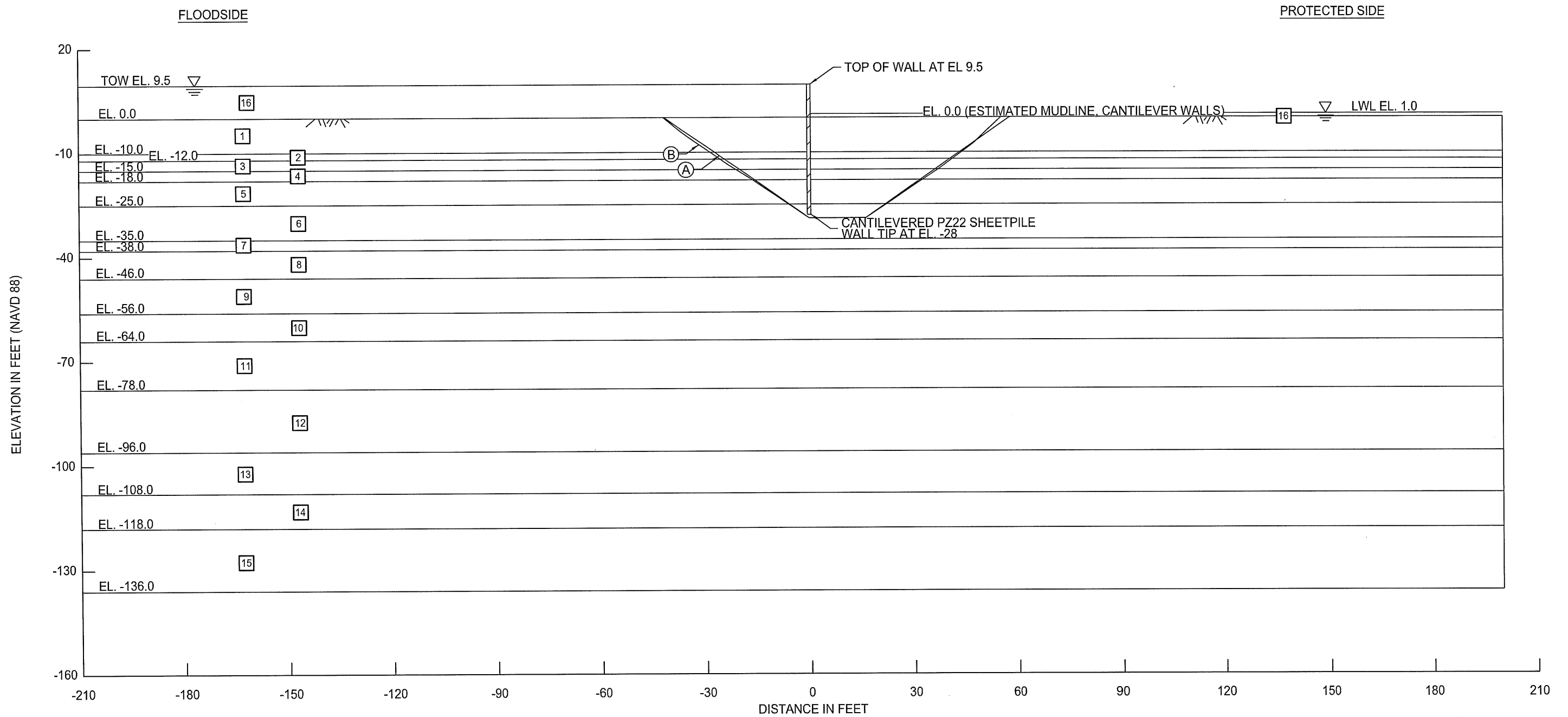

SOIL NO.	DESCRIPTION	FRICTION ANGLE IN DEGREES	UNIT WEIGHT IN PCF	COHESION IN PSF	
				AVG	BASE
1	CLAY	0	120	300	300
2	SILT	15	117	200	200
3	CLAY	0	125	500	500
4	CLAY	0	120	400	400
5	CLAY	0	112	600	775
6	CLAY	0	122	775	1025
7	CLAY	0	122	1025	1100
8	CLAY	0	125	1100	1100
9	CLAY	0	122	1325	1325
10	CLAY	0	126	1450	1450
11	CLAY	0	118	1130	1130
12	CLAY	0	115	1130	1130
13	CLAY	0	124	1825	1825
14	CLAY	0	121	2200	2200
15	CLAY	0	115	1525	1525
16	WATER	0	64	0	0

SLIP SURFACE DESIGNATION	TYPE OF SEARCH	FACTOR OF SAFETY	FILE NAME	MINIMUM REQUIRED FACTOR OF SAFETY
(A)	BLOCK SEARCH	5.70	BRACED WALL_ML_EL 0 (TOW UPPER BLOCK SPECIFIED).GSZ	1.40
(B)	FULLY SPECIFIED WITH OPTIMIZATION	5.67	BRACED WALL_ML_EL 0 (TOW FULLY SPECIFIED).GSZ	1.40

NOTES:

1. SLOPE STABILITY ANALYSIS PERFORMED USING SPENCER'S METHOD AND THE OPTIMIZATION SEARCH ROUTINE WITH SLOPE/W SOFTWARE VERSION 7.21.
2. SHEETPILE TIP ELEVATION WAS EVALUATED BASED ON CONSTRUCTION DRAWING "SHEET PILE FLOOD WALL DETAILS," SHEET 47 OF 59.
3. TOP OF WALL (TOW) AT EL 9.5 ANALYSIS GOVERN THE DESIGN SINCE THE MINIMUM FACTOR OF SAFETY FOR LOW WATER LEVEL (LWL) AND STILL WATER LEVEL (SWL) CONDITIONS HAVE BEEN EXCEEDED.



EUSTIS ENGINEERING SERVICES, L.L.C.
 GEOTECHNICAL ENGINEERS
 3011 28TH STREET METAIRIE, LOUISIANA

SLOPE STABILITY ANALYSIS
 TOP OF CANTILEVER WALL (TOW), MUDLINE AT EL. 0
 SPENCER'S METHOD

STATE OF LOUISIANA
 COASTAL PROTECTION AND RESTORATION AUTHORITY
 FRANKLIN DRAINAGE CANAL PUMP STATION
 ST. MARY PARISH, LOUISIANA
 CB&I, INC. PURCHASE ORDER NO. 827643-000 OP

DRAWN BY: J.L.S.	PLOT DATE: 25 JULY 13	CADD FILE: TOW EL 0.DGN
CHECKED BY: S.G.W.	JOB NO.: 22058	ENCLOSURE 2

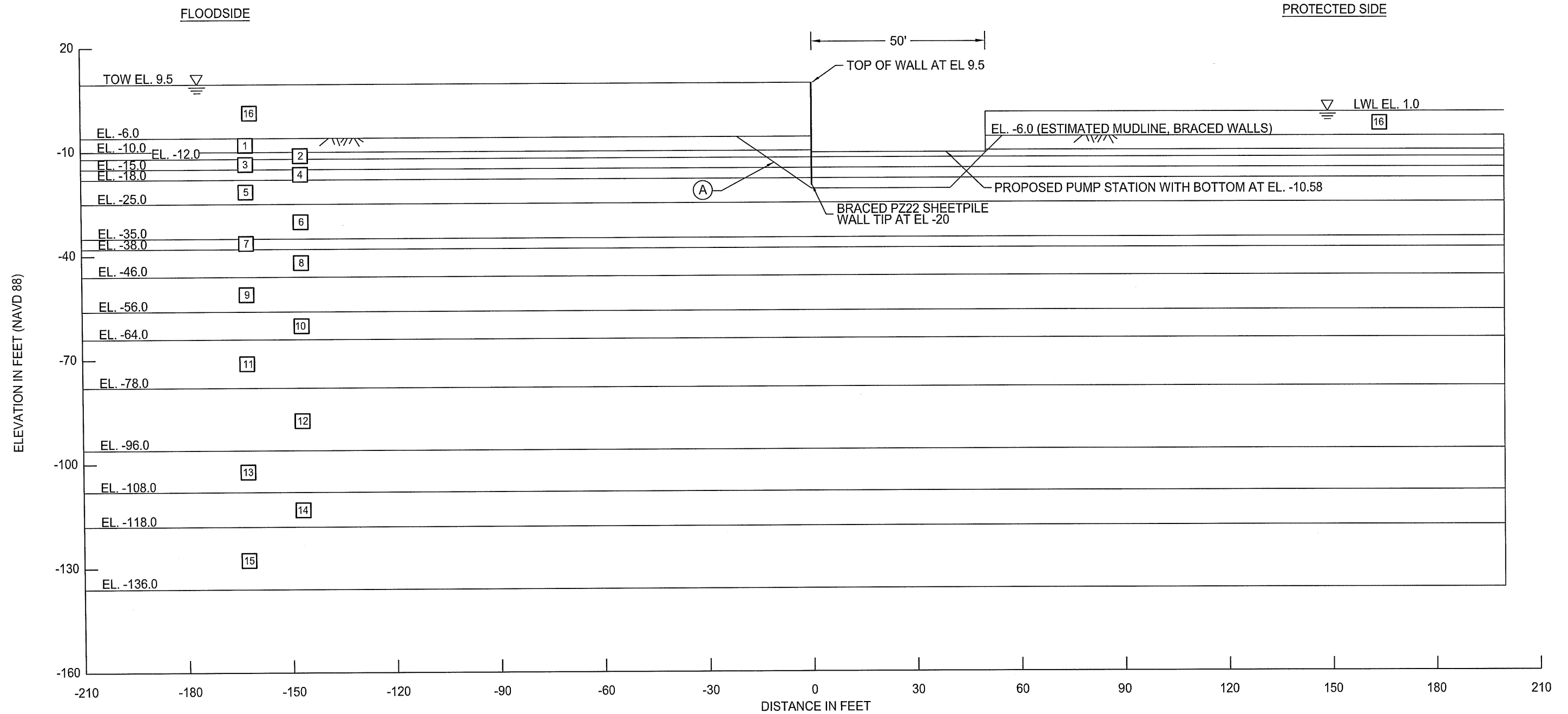

SOIL NO.	DESCRIPTION	FRICTION ANGLE IN DEGREES	UNIT WEIGHT IN PCF	COHESION IN PSF	
				AVG	BASE
1	CLAY	0	120	300	300
2	SILT	15	117	200	200
3	CLAY	0	125	500	500
4	CLAY	0	120	400	400
5	CLAY	0	112	600	775
6	CLAY	0	122	775	1025
7	CLAY	0	122	1025	1100
8	CLAY	0	125	1100	1100
9	CLAY	0	122	1325	1325
10	CLAY	0	126	1450	1450
11	CLAY	0	118	1130	1130
12	CLAY	0	115	1130	1130
13	CLAY	0	124	1825	1825
14	CLAY	0	121	2200	2200
15	CLAY	0	115	1525	1525
16	WATER	0	64	0	0

SLIP SURFACE DESIGNATION	TYPE OF SEARCH	FACTOR OF SAFETY	FILE NAME	MINIMUM REQUIRED FACTOR OF SAFETY
(A)	BLOCK SEARCH	3.15	BRACED WALL_ML_EL-6 (TOW UPPER BLOCK SPECIFIED).GSZ	1.40

NOTES:

- SLOPE STABILITY ANALYSIS PERFORMED USING SPENCER'S METHOD AND THE OPTIMIZATION SEARCH ROUTINE WITH SLOPE/W SOFTWARE VERSION 7.21.
- SHEETPILE TIP ELEVATION WAS EVALUATED BASED ON CONSTRUCTION DRAWING "SHEET PILE FLOOD WALL DETAILS," SHEET 47 OF 59.
- TOP OF WALL (TOW) AT EL 9.5 ANALYSIS GOVERN THE DESIGN SINCE THE MINIMUM FACTOR OF SAFETY FOR LOW WATER LEVEL (LWL) AND STILL WATER LEVEL (SWL) CONDITIONS HAVE BEEN EXCEEDED.
- THE OPTIMIZED SLIP SURFACE IS NOT PRESENTED BECAUSE UNREALISTIC FAILURE SURFACES INTO THE BASE OF THE PUMP STATION WERE COMPUTED.



EUSTIS ENGINEERING SERVICES, L.L.C.
 GEOTECHNICAL ENGINEERS
 3011 28TH STREET METAIRIE, LOUISIANA

**SLOPE STABILITY ANALYSIS
 TOP OF BRACED WALL (TOW)
 FRONTAL PROTECTION AT PROPOSED PUMP STATION
 SPENCER'S METHOD**

STATE OF LOUISIANA
 COASTAL PROTECTION AND RESTORATION AUTHORITY
 FRANKLIN DRAINAGE CANAL PUMP STATION
 ST. MARY PARISH, LOUISIANA
 CB&I, INC. PURCHASE ORDER NO. 827643-000 OP

DRAWN BY: J.L.S.	PLOT DATE: 25 JULY 13	CADD FILE: ENCL3.DGN
CHECKED BY: S.G.W.	JOB NO.: 22058	ENCLOSURE 3

APPENDIX B
CDBG CONSTRUCTION COMPLIANCE PROVISIONS

CDBG COMPLIANCE PROVISIONS FOR CONSTRUCTION CONTRACTS

CONTENTS

1. EQUAL EMPLOYMENT OPPORTUNITY (Equal Opportunity Clause)
2. STANDARD FEDERAL EQUAL EMPLOYMENT OPPORTUNITY
CONSTRUCTION CONTRACT SPECIFICATIONS
3. NOTICE OF REQUIREMENT FOR AFFIRMATIVE ACTION
4. CERTIFICATION OF NONSEGREGATED FACILITIES
5. CIVIL RIGHTS
6. SECTION 109 OF THE HOUSING AND COMMUNITY DEVELOPMENT ACT
OF 1974
7. SECTION 3 OF THE HOUSING AND URBAN DEVELOPMENT ACT OF 1968 -
COMPLIANCE IN THE PROVISION OF TRAINING, EMPLOYMENT AND
BUSINESS OPPORTUNITIES
8. SECTION 503 OF THE REHABILITATION ACT OF 1973 (29 USC 793)
9. SECTION 504 OF THE REHABILITATION ACT OF 1973, AS AMENDED
10. AGE DISCRIMINATION ACT OF 1975
11. CERTIFICATION OF COMPLIANCE WITH AIR AND WATER ACTS
12. SPECIAL CONDITIONS PERTAINING TO HAZARDS, SAFETY STANDARDS
AND ACCIDENT PREVENTION
13. FLOOD DISASTER PROTECTION
14. ACCESS TO RECORDS - MAINTENANCE OF RECORDS
15. INSPECTION
16. REPORTING REQUIREMENTS
17. CONFLICT OF INTEREST

18. ACTIVITIES AND CONTRACTS NOT SUBJECT TO EXECUTIVE ORDER 11246, AS AMENDED
19. PATENTS
20. COPYRIGHT
21. TERMINATION FOR CAUSE
22. TERMINATION FOR CONVENIENCE
23. ENERGY EFFICIENCY
24. SUBCONTRACTS
25. DEBARMENT, SUSPENSION, AND INELIGIBILITY
26. PROTECTION OF LIVES AND HEALTH
27. BREACH OF CONTRACT TERMS
28. PROVISIONS REQUIRED BY LAW DEEMED INSERTED
29. CHANGES
30. PERSONNEL
31. ANTI-KICKBACK RULES
32. ASSIGNABILITY
33. INTEREST OF CONTRACTOR
34. POLITICAL ACITIVITY
35. COMPLIANCE WITH THE OFFICE OF MANAGEMENT AND BUDGET
36. DISCRIMINATION DUE TO BELIEFS
37. CONFIDENTIAL FINDINGS
38. LOBBYING
39. FEDERAL LABOR STANDARDS PROVISIONS

1. EQUAL EMPLOYMENT OPPORTUNITY (Equal Opportunity Clause)
(applicable to contracts and subcontracts above \$10,000)

During the performance of this contract, the Contractor agrees as follows:

- A. The Contractor will not discriminate against any employee or applicant for employment because of race, color, religion, sex, or national origin. The Contractor will take affirmative action to ensure that applicants are employed, and that employees are treated during employment, without regard to their race, color, religion, sex, or national origin. Such action shall include, but not be limited to, the following: employment, upgrading, demotion, or transfer; recruitment or recruitment advertising; layoff or termination; rates of pay or other forms of compensation; and selection for training, including apprenticeship. The Contractor agrees to post in conspicuous places, available to employees and applicants for employment, notices to be provided setting forth the provisions of this nondiscrimination clause.
- B. The Contractor will, in all solicitations or advertisements for employees placed by or on behalf of the Contractor, state that all qualified applicants will receive consideration without regard to race, color, religion, sex, or national origin.
- C. The Contractor will send to each labor union or representative of workers with which he has a collective bargaining agreement or other contract or understanding, a notice to be provided by the Contract Compliance Officer advising the said labor union or workers' representatives of the Contractor's commitment under this section, and shall post copies of the notice in conspicuous places available to employees and applicants for employment.
- D. The Contractor will comply with all provisions of Executive Order 11246 of September 24, 1965, as amended, and the rules, regulations, and relevant orders of the Secretary of Labor.
- E. The Contractor will furnish all information and reports required by Executive Order 11246 of September 24, 1965, as amended, and by rules, regulations, and orders of the Secretary of Labor, or pursuant thereto, and will permit access to his books, records, and accounts by the Department and the Secretary of Labor for purposes of investigation to ascertain compliance with such rules, regulations, and others.
- F. In the event of the Contractor's noncompliance with the non-discrimination clauses of this contract or with any of the said rules, regulations, or orders, this contract may be cancelled, terminated, or suspended in whole or in part and the Contractor may be declared ineligible for further Government contracts in accordance with procedures authorized in Executive Order 11246 of September 24, 1965, as amended, or by rule, regulation, or order of the Secretary of Labor, or as otherwise provided by law.

G. The Contractor will include the provisions of the sentence immediately preceding paragraph A and the provisions of paragraphs A through G in every subcontract or purchase order unless exempted by rules, regulations, or orders of the Secretary of Labor issued pursuant to Section 204 of Executive Order 11246 of September 24, 1965, as amended, so that such provisions will be binding upon each subcontractor or vendor. The Contractor will take such action with respect to any subcontract or purchase order as the Department may direct as a means of enforcing such provisions, including sanctions for noncompliance. Provided, however, that in the event a contractor becomes involved in, or is threatened with, litigation with a subcontractor or vendor as a result of such direction by the Department, the Contractor may request the United States to enter into such litigation to protect the interest of the United States.

2. **STANDARD FEDERAL EQUAL EMPLOYMENT OPPORTUNITY
CONSTRUCTION CONTRACT SPECIFICATIONS**

(applicable to contracts and subcontracts above \$10,000)

A. As used in these specifications:

- (1) "Covered area" means the geographical area described in the solicitation from which this contract resulted;
- (2) "Director" means Director, Office of Federal Contract Compliance Programs, United States Department of Labor, or any person to whom the Director delegates authority;
- (3) "Employer identification number" means the Federal Social Security number used on the Employer's Quarterly Federal Tax Return, U.S. Treasury Department Form 941.
- (4) "Minority" includes:
 - (a) Black (all persons having origins in any of the Black African racial groups not of Hispanic origin);
 - (b) Hispanic (all persons of Mexican, Puerto Rican, Cuban, Central or South America or other Spanish Culture or origin, regardless of race);
 - (c) Asian and Pacific Islander (all persons having origins in any of the original people of the Far East, Southeast Asia, the Indian Subcontinent, or the Pacific Islands); and

- (d) American Indian or Alaskan Native (all persons having origins in any of the original peoples of North America and maintaining identifiable tribal affiliations through membership and participation or community identification).

- B. When the Contractor, or any subcontractor, at anytime, subcontracts a portion of the work involving any construction trade, it shall physically include in each subcontract, in excess of \$10,000, the provisions of these specifications and the Notice which contains the applicable goals for minority and female participation and which is set forth in the solicitations from which this contract resulted.

- C. If the Contractor is participating (pursuant to 41 CFR 60-4.5) in a Hometown Plan approved by the U.S. Department of Labor in the covered area either individually or through an association, its affirmative action obligations on all work in the Plan area (including goals and timetables) shall be in accordance with that Plan for those trades which have unions participating in the Plan. Contractors must be able to demonstrate their participation in compliance with the provisions of any such Hometown Plan. Each Contractor or subcontractor participating in an approved Plan is individually required to comply with its obligations under the EEO clause, and to make a good faith effort to achieve each goal under the Plan in each trade in which it has employees. The overall good faith performance by other Contractors or subcontractors toward a goal in an approved Plan does not excuse any covered Contractor's or subcontractor's failure to take good faith efforts to achieve the Plan goals and timetables.

- D. The Contractor shall implement the specific affirmative action standards provided in paragraphs G(1) through G(16) of these specifications. The goals set forth in the solicitation from which this contract resulted are expressed as percentages of the total hours of employment and training of minority and female utilization the Contractor should reasonably be able to achieve in each construction trade in which it has employees in the covered area. Covered construction contractors performing contracts in geographical areas where they do not have a federal or federally-assisted construction contract shall apply the minority and female goals established for the geographic area where the contract is being performed. Goals are published periodically in the Federal Register in notice form and such notices may be obtained from any Office of Federal Contract Compliance Programs office or from Federal procurement contracting officers. The Contractor is expected to make substantially uniform progress in meeting its goals in each craft during the period specified.

- E. Neither the provisions of any collective bargaining agreement, nor the failure by a union with whom the Contractor has a collective bargaining agreement, to refer either minorities or women shall excuse the Contractor's obligations

under these specifications, Executive Order 11246, or the regulations promulgated pursuant thereto.

- F. In order for the non-working training hours of apprentices and trainees to be counted in meeting the goals, such apprentices and trainees must be employed by the Contractor during the training period, and the Contractor must have made a commitment to employ the apprentices and trainees at the completion of their training, subject to the availability of employment opportunities. Trainees must be trained pursuant to training programs approved by the U.S. Department of Labor.
- G. The Contractor shall take specific affirmative action to ensure equal employment opportunity. The evaluation of the Contractor's compliance with these specifications shall be based upon its effort to achieve maximum results from its actions. The Contractor shall document these efforts fully, and shall implement affirmative action steps at least as extensive as the following:
- (1) Ensure and maintain a working environment free of harassment, intimidation, and coercion at all sites, and in all facilities at which the Contractor's employees are assigned to work. The Contractor, where possible, will assign two or more women to each construction project. The Contractor shall specifically ensure that all foremen, superintendents and other on-site supervisory personnel are aware of and carry out the Contractor's obligation to maintain such a working environment, with specific attention to minority or female individuals working at such sites or in such facilities.
 - (2) Establish and maintain a current list of minority and female recruitment sources, provide written notification to minority and female recruitment sources and to community organizations when the Contractor or its unions have employment opportunities available, and maintain a record of the organization's responses.
 - (3) Maintain a current file of the names, addresses, and telephone numbers of each minority and female off-the-street applicant and minority or female referral from a union, a recruitment source, or community organization and of what action was taken with respect to each such individual. If such individual was sent to the union hiring hall for referral and was not referred back to the Contractor by the union or, if referred, not employed by the Contractor, this shall be documented in the file with the reason therefore, along with whatever additional actions the Contractor may have taken.
 - (4) Provide immediate written notification to the Director when the union or unions with which the Contractor has a collective

bargaining agreement have not referred to the Contractor a minority person or woman sent by the Contractor, or when the Contractor has other information that the union referral process has impeded the Contractor's efforts to meet its obligations.

- (5) Develop on-the-job training opportunities and/or participate in training programs for the area which expressly includes minorities and women, including upgrading programs and apprenticeship and trainee programs relevant to the Contractor's employment needs, especially those programs funded or approved by the Department of Labor. The Contractor shall provide notice of these programs to the sources compiled under G(2) above.
- (6) Disseminate the Contractor's EEO policy by providing notice of the policy to unions and training programs and requesting their cooperation in assisting the Contractor in meeting its EEO obligations; by including it in any policy manual and collective bargaining agreement; by publicizing it in the company newspaper, annual report, etc.; by specific review of the policy with all management personnel and with all minority and female employees at least once a year; and by posting the company EEO policy on a bulletin board accessible to all employees at each location where construction work is performed.
- (7) Review, at least annually, the company's EEO policy and affirmative action obligations under these specifications with all employees having any responsibility for hiring, assignment, layoff, termination, or other employment decisions including specific review of these items with on-site supervisory personnel such as Superintendents, General Foreman, etc., prior to the initiation of construction work at any job site. A written record shall be made and maintained identifying the time and place of these meetings, persons attending, subject matter discussed, and disposition of the subject matter.
- (8) Disseminate the Contractor's EEO policy externally by including it in any advertising in the news media, specifically including minority and female news media, and providing written notification to and discussing the Contractor's EEO policy with other Contractors and Subcontractors with whom the Contractor does or anticipates doing business.
- (9) Direct its recruitment efforts, both oral and written, to minority, female and community organizations, to schools with minority and female students and to minority and female recruitment and training organizations serving the Contractor's recruitment area and

employment needs. Not later than one month prior to the date for acceptance of applications for apprenticeship or other training by any recruitment source, the Contractor shall send written notification to organizations such as the above, describing the openings, screening procedures, and tests to be used in the selection process.

- (10) Encourage present minority and female employees to recruit other minority persons and women and, where reasonable, provide after school, summer, and vacation employment to minority and female youth both on the site and in other areas of a Contractor's work force.
- (11) Validate all tests and other selection requirements where there is an obligation to do so under 41 CFR Part 60-3.
- (12) Conduct, at least annually, an inventory and evaluation of all minority and female personnel for promotional opportunities and encourage these employees to seek or to prepare for, through appropriate training, etc., such opportunities.
- (13) Ensure that seniority practices, job classifications, work assignments and other personnel practices, do not have a discriminatory effect by continually monitoring all personnel and employment related activities to ensure that the EEO policy and the Contractor's obligations under these specifications are being carried out.
- (14) Ensure that all facilities and company activities are nonsegregated except that separate or single-user toilet and necessary changing facilities shall be provided to assure privacy between the sexes.
- (15) Document and maintain a record of all solicitations of offers for subcontracts from minority and female construction contractors and suppliers, including circulation of solicitation to minority and female contractor associations and other business associations.
- (16) Conduct a review, at least annually, of all supervisors' adherence to and performance under the Contractor's EEO policies and affirmative action obligations.

H. Contractors are encouraged to participate in voluntary associations which assist in fulfilling one or more of their affirmative action obligations (G(1) through G(16)). The efforts of a contractor association, joint contractor-union, contractor-community, or other similar group of which the Contractor is a member and participant, may be asserted as fulfilling any one or more of its

obligations under G(1) through G(16) of these specifications provided that the Contractor actively participates in the group, makes every effort to assure that the group has a positive impact on the employment of minorities and women in the industry, ensures that the concrete benefits of the program are reflected in the Contractor's minority and female workforce participation, makes a good faith effort to meet its individual goals and timetables, and can provide access to documentation which demonstrates the effectiveness of actions taken on behalf of the Contractor. The obligation shall not be a defense for the Contractor's non-compliance.

- I. A single goal for minorities and a separate single goal for women has been established. The Contractor, however, is required to provide equal employment opportunity and to take affirmative action for all minority groups, both male and female, and all women, both minority and non-minority. Consequently, the Contractor may be in violation of the Executive Order if a particular group is employed in a substantially disparate manner (for example, even though the Contractor has achieved its goals for women generally, the Contractor may be in violation of the Executive Order if a specific minority group of women is underutilized).
- J. The Contractor shall not use the goals and timetables or affirmative action standards to discriminate against any persons because of race, color, religion, sex, or national origin.
- K. The Contractor shall not enter into any subcontract with any person or firm debarred from government contracts pursuant to E.O. 11246.
- L. The Contractor shall carry out such sanctions and penalties for violation of these specifications and of the Equal Opportunity Clause including suspension, termination, and cancellation of existing subcontracts as may be imposed or ordered pursuant to E.O. 11246, as amended.
- M. The Contractor, in fulfilling its obligations under these specifications, shall implement specific affirmative action steps, at least as extensive as those standards prescribed in paragraph G of these specifications, so as to achieve maximum results from its efforts to ensure equal employment opportunity. If the Contractor fails to comply with the requirements of the Executive Order, the implementing regulations, or these specifications, the Director shall proceed in accordance with 41 CFR 60-4.8.
- N. The Contractor shall designate a responsible official to monitor all employment related activity to ensure that the company EEO policy is being carried out, to submit reports relating to the provisions hereof as may be required by the government and to keep records. Records shall at least include for each employee, the name, address, telephone numbers, construction trade, union affiliation if any, employee identification number

where assigned, social security number, race, sex, status (e.g., mechanic, apprenticeship trainee, helper, or laborer), dates of changes in status, hours worked per week in the indicated trade, rate of pay, and location at which the work was performed. Records shall be maintained in an easily understandable and retrievable form; however, to the degree that existing records satisfy this requirement, Contractors shall not be required to maintain separate records.

- O. Nothing herein provided shall be construed as a limitation upon the application of other laws which establish different standards of compliance or upon the application or requirements for the hiring of local or other area residents (e.g., those under the Public Works Employment Act of 1977 and the Community Development Block Grant Program).

3. **NOTICE OF REQUIREMENT FOR AFFIRMATIVE ACTION**
(applicable to contracts and subcontract over \$10,000)

- A. The Offeror's or Bidder's attention is called to the "Equal Opportunity Clause" and the "Standard Federal Equal Employment Opportunity Construction Contract Specifications" set forth herein.
- B. The goals and timetables for minority and female participation, expressed in percentage terms for the Contractor's aggregate workforce in each trade on all construction work in the covered area, are as follows:

Goals for minority participation: _____ *(see table below)*

Goals for female participation: _____ 6.9%

These goals are applicable to all the Contractor's construction work (whether or not it is federal or federally assisted) performed in the covered area. If the contractor performs construction work in a geographic area located outside of the covered area, it shall apply the goals established for such geographic area where the work is actually performed.

With regard to this second area, the Contractor also is subject to the goals for both its federally involved and non-federally involved construction. The Contractor's compliance with the Executive Order and the regulations in 41 CFR Part 60-4 shall be based on its implementation of the Equal Opportunity Clause, specific affirmative action obligations required by the specifications set forth in 41 CFR 60-4.3 (a) and its efforts to meet the goals established for the geographical area where the contract resulting from this solicitation is to be performed. The hours of minority and female employment and training must be substantially uniform throughout the length of the contract, and in each trade, and the Contractor shall make a good faith effort to employ

minorities and women evenly on each of its projects. The transfer of minority or female employees or trainees from Contractor to Contractor or from project to project for the sole purpose of meeting the Contractor's goals shall be a violation of the contract, the Executive Order, and the regulations in 41 CFR Part 60-4. Compliance with the goals will be measured against the total work hours performed.

MINORITY PARTICIPATION GOALS

PARISH	MIN. GOAL (%)	PARISH	MIN. GOAL (%)	PARISH	MIN. GOAL (%)	PARISH	MIN. GOAL (%)
Acadia	24.1	E. Baton Rouge	26.1	Madison	27.9	St. Landry	24.1
Allen	17.8	East Carroll	27.9	Morehouse	27.9	St. Martin	24.1
Ascension	26.1	East Feliciana	30.4	Natchitoches	29.3	St. Mary	24.1
Assumption	27.7	Evangeline	24.1	Orleans	31.0	St. Tammany	31.0
Avoyelles	29.3	Franklin	27.9	Ouachita	22.8	Tangipahoa	27.7
Beauregard	17.8	Grant	25.7	Plaquemines	27.7	Tensas	27.9
Bienville	29.3	Iberia	24.1	Pointe Coupee	30.4	Terrebonne	27.7
Bossier	29.3	Iberville	30.4	Rapides	25.7	Union	27.9
Caddo	29.3	Jackson	27.9	Red River	29.3	Vermilion	24.1
Calcasieu	19.3	Jefferson	31.0	Richland	27.9	Vernon	17.8
Caldwell	27.9	Jefferson Davis	17.8	Sabine	29.3	Washington	27.7
Cameron	17.8	Lafayette	20.6	St. Bernard	31.0	Webster	29.3
Catahoula	27.9	Lafourche	27.7	St. Charles	27.7	W. Baton Rouge	26.1
Claiborne	29.3	LaSalle	27.9	St. Helena	30.4	West Carroll	27.9
Concordia	30.4	Lincoln	27.9	St. James	27.7	West Feliciana	30.4
De Soto	29.3	Livingston	26.1	St. John the Baptist	27.7	Winn	29.3

C. The Contractor shall provide written notification to the Director of the Office of Federal Contract Compliance Programs within 10 working days of award of any construction subcontract in excess of \$10,000 at any tier for construction work under the contract resulting from this solicitation. The notification shall list the name, address, and telephone number of the subcontractor; employer identification number; estimated dollar amount of the subcontract; estimated starting and completion dates of the sub-contract; and the geographical area in which the contract is to be performed.

D. As used in this Notice, and in the contract resulting from this solicitation, the "covered area" is *(insert description of the geographical areas where the contract is to be performed, giving the State, parish, and city, if any)*:

4. CERTIFICATION OF NONSEGREGATED FACILITIES
(applicable to contracts and subcontracts over \$10,000)

By the submission of this bid, the bidder, offeror, applicant or subcontractor certifies that he/she does not maintain or provide for his/her establishments, and that he/she does not permit employees to perform their services at any location,

under his/her control, where segregated facilities are maintained. He/she certifies further that he/she will not maintain or provide for employees any segregated facilities at any of his/her establishments, and he/she will not permit employees to perform their services at any location under his/her control where segregated facilities are maintained. The bidder, offeror, applicant or subcontractor agrees that a breach of this certification is a violation of the equal opportunity clause of this contract.

As used in this certification, the term "segregated facilities" means any waiting rooms, work areas, rest rooms and wash rooms, restaurants and other eating areas, time clocks, locker rooms, and other storage or dressing areas, parking lots, drinking fountains, recreation or entertainment areas, transportation and housing facilities provided for employees which are segregated by explicit directive or are, in fact, segregated on the basis of race, color, religion, or national origin because of habit, local custom, or any other reason.

He/she further agrees that (except where he/she has obtained for specific time periods) he/she will obtain identical certification from proposed subcontractors prior to the award of subcontracts exceeding \$10,000 which are not exempt from the provisions of the equal opportunity clause; that he/she will retain such certifications in his/her files; and that he/she will forward the following notice to such proposed subcontractors (except where proposed subcontractors have submitted identical certifications for specific time periods).

5. CIVIL RIGHTS

The Contractor shall comply with the provisions of Title VI of the Civil Rights Act of 1964. No person shall, on the grounds of race, color, or national origin, be excluded from participation in, be denied the benefits of, or be subjected to discrimination under any program or activity receiving federal financial assistance.

6. SECTION 109 OF THE HOUSING AND COMMUNITY DEVELOPMENT ACT OF 1974

The Contractor shall comply with the provisions of Section 109 of the Housing and Community Development Act of 1974. No person in the United States shall on the grounds of race, color, national origin, or sex be excluded from participation in, be denied the benefits of, or be subjected to discrimination under any program or activity funded in whole or in part with funds made available under this title. Section 109 further provides that discrimination on the basis of age under the Age Discrimination Act of 1975 or with respect to an otherwise qualified handicapped individual as provided in Section 504 of the Rehabilitation Act of 1973, as amended, is prohibited.

7. **SECTION 3 OF THE HOUSING AND URBAN DEVELOPMENT ACT OF 1968 - COMPLIANCE IN THE PROVISION OF TRAINING, EMPLOYMENT AND BUSINESS OPPORTUNITIES**

- A. The work to be performed under this contract is subject to the requirements of Section 3 of the Housing and Urban Development Act of 1968, as amended, 12 U.S.C. 1701u (section 3). The purpose of section 3 is to ensure that employment and other economic opportunities generated by HUD assistance or HUD-assisted projects covered by Section 3, shall, to the greatest extent feasible, be directed to low- and very low-income persons, particularly persons who are recipients of HUD assistance for housing.
- B. The parties to this contract agree to comply with HUD's regulations in 24 CFR part 135, which implement Section 3. As evidenced by their execution of this contract, the parties to this contract certify that they are under no contractual or other impediment that would prevent them from complying with the part 135 regulations.
- C. The contractor agrees to send to each labor organization or representative of workers with which the contractor has a collective bargaining agreement or other understanding, if any, a notice advising the labor organization or workers' representative of the contractor's commitments under this Section 3 clause, and will post copies of the notice in conspicuous places at the work site where both employees and applicants for training and employment positions can see the notice. The notice shall describe the Section 3 preference, shall set forth minimum number and job titles subject to hire, availability of apprenticeship and training positions, the qualifications for each, and the name and location of the person(s) taking applications for each of the positions, and the anticipated date the work shall begin.
- D. The contractor agrees to include this Section 3 clause in every subcontract subject to compliance with regulations in 24 CFR part 135, and agrees to take appropriate action, as provided in an applicable provision of the subcontract or in this Section 3 clause, upon a finding that the subcontractor is in violation of the regulations in 24 CFR part 135. The contractor will not subcontract with any subcontractor where the contractor has notice or knowledge that the subcontractor has been found in violation of the regulations in 24 CFR part 135.
- E. The contractor will certify that any vacant employment positions, including training positions, that are filled (1) after the contractor is selected but before the contract is executed, and (2) with persons other than those to whom the regulations of 24 CFR part 135 require employment opportunities to be directed, were not filled to circumvent the contractor's obligations under 24 CFR part 135.

- F. Noncompliance with HUD's regulations in 24 CFR part 135 may result in sanctions, termination of this contract for default, and debarment or suspension from future HUD assisted contracts.
- G. With respect to work performed in connection with Section 3 covered Indian housing assistance, Section 7(b) of the Indian Self-Determination and Education Assistance Act (25 U.S.C. 450e) also applies to the work to be performed under this contract. Section 7(b) requires that to the greatest extent feasible (i) preference and opportunities for training and employment shall be given to Indians, and (ii) preference in the award of contracts and subcontracts shall be given to Indian organizations and Indian-owned Economic Enterprises. Parties to this contract that are subject to the provisions of Section 3 and section 7(b) agree to comply with Section 3 to the maximum extent feasible, but not in derogation of compliance with Section 7(b).

8. **SECTION 503 OF THE REHABILITATION ACT OF 1973 (29 USC 793)**
(applicable to contracts and subcontracts over \$10,000)

- A. The contractor will not discriminate against any employee or applicant for employment because of physical or mental handicap in regard to any position for which the employee or applicant for employment is otherwise qualified. The contractor agrees to take affirmative action to employ, advance in employment and otherwise treat qualified handicapped individuals without discrimination based upon their physical or mental handicap in all employment practices such as the following: employment upgrading, demotion or transfer, recruitment, advertising, layoff or termination, rates of pay or other forms of compensation, and selection for training, including apprenticeship.
- B. The Contractor agrees to comply with the rules, regulations, and relevant orders of the Secretary of Labor issued pursuant to the Act.
- C. In the event of the Contractor's noncompliance with the requirements of this clause, actions for noncompliance may be taken in accordance with the rules, regulations, and relevant orders of the Secretary of Labor issued pursuant to the Act.
- D. The Contractor agrees to post in conspicuous places, available to employees and applicants for employment, notices in a form to be prescribed by the Director, provided by or through the contracting officer. Such notices shall state the Contractor's obligation under the law to take affirmative action to employ and advance in employment qualified handicapped employees and applicants for employment, and the rights of applicants and employees.

- E. The Contractor will notify each labor union or representative of workers with which it has a collective bargaining agreement or other contract understanding, that the Contractor is bound by the terms of Section 503 of the Rehabilitation Act of 1973, and is committed to take affirmative action to employ and advance in employment physically and mentally handicapped individuals.
- F. The Contractor will include the provisions of this clause in every subcontract or purchase order of \$10,000 or more unless exempted by rules, regulations, or orders of the Secretary issued pursuant to Section 503 of the Act, so that such provisions will be binding upon each subcontractor or vendor. The Contractor will take such action with respect to any subcontract or purchase order as the Director of the Office of Federal Contract Compliance Programs may direct to enforce such provisions, including action for noncompliance.

9. SECTION 504 OF THE REHABILITATION ACT OF 1973, AS AMENDED

The Contractor agrees that no otherwise qualified individual with disabilities shall, solely by reason of his disability, be denied the benefits, or be subjected to discrimination including discrimination in employment, any program or activity that receives the benefits from the federal financial assistance.

10. AGE DISCRIMINATION ACT OF 1975

The Contractor shall comply with the provisions of the Age Discrimination Act of 1975. No person in the United States shall, on the basis of age, be excluded from participation in, be denied the benefits of, or be subjected to discrimination under, any program or activity receiving federal financial assistance.

11. CERTIFICATION OF COMPLIANCE WITH AIR AND WATER ACTS

(applicable to contracts and subcontracts exceeding \$100,000)

The Contractor and all subcontractors shall comply with the requirements of the Clean Air Act, as amended, 42 USC 1857 et seq., the Federal Water Pollution Control Act, as amended, 33 USC 1251 et seq., and the regulations of the Environmental Protection Agency with respect thereto, at 40 CFR Part 15, as amended.

In addition to the foregoing requirements, all nonexempt contractors and subcontractors shall furnish to the owner, the following:

- A. A stipulation by the Contractor or subcontractors, that any facility to be utilized in the performance of any nonexempt contract or subcontract, is not listed on

the List of Violating Facilities issued by the Environmental Protection Agency (EPA) pursuant to 40 CFR Part 15, as amended.

- B. Agreement by the Contractor to comply with all the requirements of Section 114 of the Clean Air Act, as amended, (42 USC 1857 c-8) and Section 308 of the Federal Water Pollution Control Act, as amended, (33 USC 1318) relating to inspection, monitoring, entry, reports and information, as well as all other requirements specified in said Section 114 and Section 308, and all regulations and guidelines issued thereunder.
- C. A stipulation that as a condition for the award of the contract, prompt notice will be given of any notification received from the Director, Office of Federal Activities, EPA, indicating that a facility utilized, or to be utilized for the contract, is under consideration to be listed on the EPA List of Violating Facilities.
- D. Agreement by the Contractor that he will include, or cause to be included, the criteria and requirements in paragraph (1) through (4) of this section in every nonexempt subcontract and requiring that the Contractor will take such action as the government may direct as a means of enforcing such provisions.

12. SPECIAL CONDITIONS PERTAINING TO HAZARDS, SAFETY STANDARDS AND ACCIDENT PREVENTION

- A. Lead-Based Paint Hazards
(include in contracts for construction or rehabilitation of residential structures)

The construction or rehabilitation of residential structures is subject to the HUD Lead-Based Paint regulations, 24 CFR Part 35. The Contractor and subcontractors shall comply with the provisions for the elimination of lead-based paint hazards under Subpart B of said regulations. The Owner will be responsible for the inspections and certifications required under Section 35.14 (f) thereof.

- B. Use of Explosives (Modify as required)

When the use of explosives is necessary for the prosecution of the work, the Contractor shall observe all local, state and federal laws in purchasing and handling explosives. The Contractor shall take all necessary precaution to protect completed work, neighboring property, water lines, or other underground structures. Where there is danger to structures or property from blasting, the charges shall be reduced and the material shall be covered with suitable timber, steel or rope mats.

The Contractor shall notify all owners of public utility property of intention to use explosives at least 8 hours before blasting is done close to such property.

Any supervision or direction of use of explosives by the engineer does not in any way reduce the responsibility of the Contractor or his Surety for damages that may be caused by such use.

C. Danger Signals and Safety Devices (Modify as Required)

The Contractor shall make all necessary precautions to guard against damages to property and injury to persons. He shall put up and maintain in good condition, sufficient red or warning lights at night, suitable barricades and other devices necessary to protect the public. In case the Contractor fails or neglects to take such precautions, the Owner may have such lights and barricades installed and charge the cost of this work to the Contractor. Such action by the Owner does not relieve the Contractor of any liability incurred under these specifications or contract.

13. FLOOD DISASTER PROTECTION

This contract is subject to the requirements of the Flood Disaster Protection Act of 1973 (P.L. 93-234). Nothing included as a part of this contract is approved for acquisition or construction purposes as defined under Section 3(a) of said Act, for use in an area identified by the Secretary of HUD as having special flood hazards which is located in a community not then in compliance with the requirements for participation in the National Flood Insurance Program pursuant to Section 201(d) of said Act; and the use of any assistance provided under this contract for such acquisition for construction in such identified areas in communities then participating in the National Flood Insurance Program shall be subject to the mandatory purchase of flood insurance requirements or Section 102(a) of said Act.

Any contract or agreement for the sale, lease, or other transfer of land acquired, cleared or improved with assistance provided under this Contract shall contain, if such land is located in an area identified by the Secretary as having special flood hazards and in which the sale of flood insurance has been made available under the National Flood Insurance Act of 1968, as amended, 42 U.S.C. 4001 et seq., provisions obligating the transferee and its successors or assigns to obtain and maintain, during the ownership of such land, such flood insurance as required with respect to financial assistance for acquisition or construction purposes under Section 102(a) of Flood Disaster Protection Act of 1973.

14. ACCESS TO RECORDS - MAINTENANCE OF RECORDS

The State of Louisiana, the Department of Housing and Urban Development, the Comptroller General of the United States, or any of their duly authorized representatives, shall have access to any books, documents, papers and records

of the Contractor which are directly pertinent to this specific contract, for the purpose of audits, examinations, and making excerpts and transcriptions. All records connected with this contract will be maintained in a central location by the unit of local government and will be maintained for a period of five (5) years from the official date of the State's final closeout of the grant.

15. INSPECTION

The authorized representative and agents of the State of Louisiana and the Department of Housing and Urban Development shall be permitted to inspect all work, materials, payrolls, records of personnel, invoices of materials, and other relevant data and records.

16. REPORTING REQUIREMENTS

The Contractor shall complete and submit all reports, in such form and according to such schedule, as may be required by the Owner.

17. CONFLICT OF INTEREST

A. No officer or employee of the local jurisdiction or its designees or agents, no member of the governing body, and no other public official of the locality who his/her tenure or for one year thereafter, shall have any interest, direct or indirect, in any contract or subcontract, or the proceeds thereof, for work to be performed. Further, the Contractor shall cause to be incorporated in all subcontracts the language set forth in this paragraph prohibiting conflict of interest.

B. No member of or delegate to Congress, or Resident Commissioner, shall be admitted to any share or part of this contract or to any benefit that may arise therefrom, but this provision shall not be construed to extend to this contract if made with a corporation for its general benefit.

18. ACTIVITIES AND CONTRACTS NOT SUBJECT TO EXECUTIVE ORDER 11246, AS AMENDED

(applicable to contracts and subcontracts of \$10,000 and under)

During the performance of this contract, the Contractor agrees as follows:

A. The Contractor shall not discriminate against any employee or applicant for employment because of race, color, religion, sex, or national origin. The Contractor shall take affirmative action to ensure that applicants for

employment are employed, and that employees are treated during employment, without regard to their race, color, religion, sex, or national origin. Such action shall include, but not be limited to, the following: employment, upgrading, demotion, or transfer; recruitment or recruitment advertising; layoff or termination; rates of pay or other forms of compensation; and selection for training, including apprenticeship.

- B. The Contractor shall post in conspicuous places, available to employees and applicants for employment, notices to be provided by Contracting Officer setting forth the provisions of this non-discrimination clause. The Contractor shall state that all qualified applicants will receive consideration for employment without regard to race, color, religion, sex, or national origin.
- C. Contractors shall incorporate foregoing requirements in all subcontracts.

19. PATENTS

- A. The Contractor shall hold and save the Owner and its officers, agents, servants, and employees harmless from liability of any nature or kind, including cost and expenses for, or on account of any patented or unpatented invention, process, article, or appliance manufactured or used in the performance of the contract including its use by the Owner, unless otherwise specifically stipulated in the Contract Document.
- B. License or Royalty Fees: License and/or Royalty Fees for the use of a process which is authorized by the Owner of the project must be reasonable, and paid to the holder of the patent, or his authorized license, direct by the Owner and not by or through the Contractor.
- C. If the Contractor uses any design device or materials covered by letters, patent or copyright, he shall provide for such use by suitable agreement with the owner of such patented or copy-righted design device or material. It is mutually agreed and understood, that without exception the contract prices shall include all royalties or costs arising from the use of such design, device or materials, in any way involved in the work. The Contractor and/or his Sureties shall indemnify and save harmless the Owner of the project from any and all claims for infringement by reason of the use of such patented or copy-righted design, device or materials or any trademark or copy-right in connection with work agreed to be performed under this contract, and shall indemnify the Owner for any cost, expense, or damage which it may be obliged to pay by reason of such infringement at any time during the prosecution of the work or after completion of the work.

20. COPYRIGHT

No materials, to include but not limited to reports, maps, or documents produced as a result of this contract, in whole or in part, shall be available to the Contractor for copyright purposes. Any such materials produced as a result of this contract that might be subject to copyright shall be the property of the Owner and all such rights shall belong to the Owner.

21. TERMINATION FOR CAUSE

If, through any cause, the Contractor shall fail to fulfill in a timely and proper manner his obligations under this contract, or if the Contractor shall violate any of the covenants, agreements, or stipulations of this contract, the Owner shall thereupon have the right to terminate this contract by giving written notice to the Contractor of such termination and specifying the effective date thereof, at least five (5) days before the effective date of such termination. In such event, all finished or unfinished documents, data, studies, surveys, drawings, maps, models, photographs, and reports prepared by the Contractor under this contract shall, at the option of the Owner, become the Owner's property and the Contractor shall be entitled to receive just and equitable compensation for any work satisfactorily completed hereunder. Notwithstanding the above, the Contractor shall not be relieved of liability to the Owner for damages sustained by the Owner by virtue of any breach of the contract by the Contractor, and the Owner may withhold any payments to the Contractor for the purpose of set-off until such time as the exact amount of damages due the Owner from the Contractor is determined.

22. TERMINATION FOR CONVENIENCE

The Owner may terminate this contract at any time by giving at least ten (10) days notice in writing to the Contractor. If the contract is terminated by the Owner as provided herein, the Contractor will be paid for the time provided and expenses incurred up to the termination date.

23. ENERGY EFFICIENCY

The Contractor shall comply with mandatory standards and policies relating to energy efficiency which are contained in the state energy conservation plan issued in compliance with the Energy Policy and Conservation Act (Public Law 94-163).

24. SUBCONTRACTS

- A. The Contractor shall not enter into any subcontract with any subcontractor who has been debarred, suspended, declared ineligible, or voluntarily excluded from participating in contracting programs by any agency of the United States Government or the State of Louisiana.
- B. The Contractor shall be as fully responsible to the Owner for the acts and omissions of the Contractor's subcontractors, and of persons either directly or indirectly employed by them, as he is for the acts and omissions of persons directly employed by the Contractor.
- C. The Contractor shall cause appropriate provisions to be inserted in all subcontracts relative to the work to bind subcontractor to the Contractor by the terms of the contract documents insofar as applicable to the work of subcontractors and to give the Contractor the same power as regards terminating any subcontract that the Owner may exercise over the Contractor under any provision of the contract documents.
- D. Nothing contained in this contract shall create any contractual relation between any subcontractor and the Owner.

25. DEBARMENT, SUSPENSION, AND INELIGIBILITY

The Contractor represents and warrants that it and its subcontractors are not debarred, suspended, or placed in ineligibility status under the provisions of 24 CFR 24 (government debarment and suspension regulations).

26. PROTECTION OF LIVES AND HEALTH

The Contractor shall exercise proper precaution at all times for the protection of persons and property and shall be responsible for all damages to persons or property, either on or off the worksite, which occur as a result of his prosecution of the work. The safety provisions of applicable laws and building and construction codes, in addition to specific safety and health regulations described by Chapter XIII, Bureau of Labor Standards, Department of Labor, Part 1518, Safety and Health Regulations for Construction, as outlined in the Federal Register, Volume 36, No. 75, Saturday, April 17, 1971, Title 29 - LABOR, shall be observed and the Contractor shall take or cause to be taken, such additional safety and health measures as the Owner may determine to be reasonably necessary.

27. BREACH OF CONTRACT TERMS

Any violation or breach of terms of this contract on the part of the Contractor or the Contractor's subcontractors may result in the suspension or termination of this contract or such other action that may be necessary to enforce the rights of the parties of this contract. The duties and obligations imposed by the contract documents and the rights and remedies available thereunder shall be in addition to and not a limitation of any duties, obligations, rights and remedies otherwise imposed or available by law.

28. PROVISIONS REQUIRED BY LAW DEEMED INSERTED

Each and every provision of law and clause required by law to be inserted in this contract shall be deemed to be inserted herein and the contract shall be read and enforced as though it were included herein, and if through mistake or otherwise any such provision is not inserted, or is not correctly inserted, then upon the application of either party the contract shall forthwith be physically amended to make such insertion or correction.

29. CHANGES

The Owner may, from time to time, request changes in the scope of the services of the Contractor to be performed hereunder. Such changes, including any increase or decrease in the amount of the Contractor's compensation which are mutually agreed upon by and between the Owner and the Contractor, shall be incorporated in written and executed amendments to this Contract.

30. PERSONNEL

The Contractor represents that it has, or will secure at its own expense, all personnel required in performing the services under this Contract. Such personnel shall not be employees of or have any contractual relationship with the Owner.

All the services required hereunder will be performed by the Contractor or under its supervision, and all personnel engaged in the work shall be fully qualified and shall be authorized or permitted under State and local law to perform such services.

No person who is serving sentence in a penal or correctional institution shall be employed on work under this Contract.

31. ANTI-KICKBACK RULES

Salaries of personnel performing work under this Contract shall be paid unconditionally and not less often than once a month without payroll deduction or rebate on any account except only such payroll deductions as are mandatory by law or permitted by the applicable regulations issued by the Secretary of Labor pursuant to the "Anti-Kickback Act" of June 13, 1934 (48 Stat. 948; 62 Stat. 740; 63 Stat. 108; Title 18 U.S.C. 874; and Title 40 U.S.C. 276c). The Contractor shall comply with all applicable "Anti-Kickback" regulations and shall insert appropriate provisions in all subcontracts covering work under this contract to insure compliance by the subcontractors with such regulations, and shall be responsible for the submission of affidavits required of subcontractors thereunder except as the Secretary of Labor may specifically provide for variations of or exemptions from the requirements thereof.

32. ASSIGNABILITY

The Contractor shall not assign any interest in this Contract, and shall not transfer any interest in the same (whether by assignment or novation) without prior written approval of the Owner provided that claims for money due or to become due the Contractor from the Owner under this Contract may be assigned to a bank, trust company, or other financial institution, or to a Trustee in Bankruptcy, without such approval. Notice of any such assignment or transfer shall be furnished promptly to the Owner.

33. INTEREST OF CONTRACTOR

The Contractor covenants that he presently has no interest and shall not acquire any interest direct or indirect in the above described project or any parcels therein or any other interest which would conflict in any manner or degree with the performance of his services hereunder. The Contractor further covenants that in the performance of this Contract no person having any such interest shall be employed.

34. POLITICAL ACTIVITY

The Contractor will comply with the provisions of the Hatch Act (5 U.S.C. 1501 et seq.), which limits the political activity of employees.

35. COMPLIANCE WITH THE OFFICE OF MANAGEMENT AND BUDGET

The parties agree to comply with the regulations, policies, guidelines, and requirements of the Office of Management and Budget, Circulars A-95, A-102, A-133, and A-54, as they relate to the use of Federal funds under this contract.

36. DISCRIMINATION DUE TO BELIEFS

No person with responsibilities in operation of the project to which this grant relates will discriminate with respect to any program participant or any applicant for participation in such program because of political affiliation or beliefs.

37. CONFIDENTIAL FINDINGS

All of the reports, information, data, etc., prepared or assembled by the Contractor under this Contract are confidential, and the Contractor agrees that they shall not be made available to any individual or organization without prior written approval of the Owner.

38. LOBBYING

The Contractor certifies, to the best of his or her knowledge and belief that:

1. No federally appropriated funds have been paid or will be paid, by or on behalf of the contractor, to any person for influencing or attempting to influence an officer or employee of any agency, a member of Congress, an officer or employee of Congress, or an employee of a member of Congress in connection with the awarding of any federal contract, the making of any federal grant, the making of any federal loan, the entering into of any cooperative agreement, and the extension, continuation, renewal, amendment, or modification of any federal contract, grant, loan, or cooperative agreement.
2. If any funds other than federally appropriated funds have been paid or will be paid to any person for influencing or attempting to influence an officer or employee of any agency, a member of Congress, an officer or employee of Congress, or an employee of a member of Congress in connection with this federal contract, grant, loan, or cooperative agreement, the contractor shall complete and submit Standard Form-LLL, "Disclosure Form to Report Lobbying," in accordance with its instructions.

39. FEDERAL LABOR STANDARDS PROVISIONS

The Contractor shall abide by the requirements of the Federal Labor Standards Provisions (form HUD-4010) as follows.

**Federal Labor Standards Provisions
U.S. Department of Housing and Urban Development
Office of Labor Relations**

Applicability

The Project or Program to which the construction work covered by this contract pertains is being assisted by the United States of America and the following Federal Labor Standards Provisions are included in this Contract pursuant to the provisions applicable to such Federal assistance.

A. 1. (i) Minimum Wages. All laborers and mechanics employed or working upon the site of the work will be paid unconditionally and not less often than once a week, and without subsequent deduction or rebate on any account (except such payroll deductions as are permitted by regulations issued by the Secretary of Labor under the Copeland Act (29 CFR Part 3), the full amount of wages and bona fide fringe benefits (or cash equivalents thereof) due at time of payment computed at rates not less than those contained in the wage determination of the Secretary of Labor which is attached hereto and made a part hereof, regardless of any contractual relationship which may be alleged to exist between the contractor and such laborers and mechanics. Contributions made or costs reasonably anticipated for bona fide fringe benefits under Section I(b)(2) of the Davis-Bacon Act on behalf of laborers or mechanics are considered wages paid to such laborers or mechanics, subject to the provisions of 29 CFR 5.5(a)(1)(iv); also, regular contributions made or costs incurred for more than a weekly period (but not less often than quarterly) under plans, funds, or programs, which cover the particular weekly period, are deemed to be constructively made or incurred during such weekly period.

Such laborers and mechanics shall be paid the appropriate wage rate and fringe benefits on the wage determination for the classification of work actually performed, without regard to skill, except as provided in 29 CFR 5.5(a)(4). Laborers or mechanics performing work in more than one classification may be compensated at the rate specified for each classification for the time actually worked therein: Provided, That the employer's payroll records accurately set forth the time spent in each classification in which work is performed. The wage determination (including any additional classification and wage rates conformed under 29 CFR 5.5(a)(1)(ii) and the Davis-Bacon poster (WH-1321) shall be posted at all times by the contractor and its subcontractors at the site of the work in a prominent and accessible, place where it can be easily seen by the workers.

(ii) (a) Any class of laborers or mechanics which is not listed in the wage determination and which is to be employed under the contract shall be classified in conformance with the wage determination. HUD shall approve an additional classification and wage rate and fringe benefits therefor only when the following criteria have been met:

(1) The work to be performed by the classification requested is not performed by a classification in the wage determination; and

(2) The classification is utilized in the area by the construction industry; and

(3) The proposed wage rate, including any bona fide fringe benefits, bears a reasonable relationship to the wage rates contained in the wage determination.

(b) If the contractor and the laborers and mechanics to be employed in the classification (if known), or their representatives, and HUD or its designee agree on the classification and wage rate (including the amount designated for fringe benefits where appropriate), a report of the action taken shall be sent by HUD or its designee to the Administrator of the Wage and Hour Division, Employment Standards Administration, U.S. Department of Labor, Washington, D.C. 20210. The Administrator, or an authorized representative, will approve, modify, or disapprove every additional classification action within 30 days of receipt and so advise HUD or its designee or will notify HUD or its designee within the 30-day period that additional time is necessary. (Approved by the Office of Management and Budget under OMB control number 1215-0140.)

(c) In the event the contractor, the laborers or mechanics to be employed in the classification or their representatives, and HUD or its designee do not agree on the proposed classification and wage rate (including the amount designated for fringe benefits, where appropriate), HUD or its designee shall refer the questions, including the views of all interested parties and the recommendation of HUD or its designee, to the Administrator for determination. The Administrator, or an authorized representative, will issue a determination within 30 days of receipt and so advise HUD or its designee or will notify HUD or its designee within the 30-day period that additional time is necessary. (Approved by the Office of Management and Budget under OMB Control Number 1215-0140.)

(d) The wage rate (including fringe benefits where appropriate) determined pursuant to subparagraphs (1)(ii)(b) or (c) of this paragraph, shall be paid to all workers performing work in the classification under this contract from the first day on which work is performed in the classification.

(iii) Whenever the minimum wage rate prescribed in the contract for a class of laborers or mechanics includes a fringe benefit which is not expressed as an hourly rate, the contractor shall either pay the benefit as stated in the wage determination or shall pay another bona fide fringe benefit or an hourly cash equivalent thereof.

(iv) If the contractor does not make payments to a trustee or other third person, the contractor may consider as part of the wages of any laborer or mechanic the amount of any costs reasonably anticipated in providing bona fide fringe benefits under a plan or program, Provided, That the Secretary of Labor has found, upon the written request of the contractor, that the applicable standards of the Davis-Bacon Act have been met. The Secretary of Labor may require the contractor to set aside in a separate account assets for the meeting of obligations under the plan or program. (Approved by the Office of Management and Budget under OMB Control Number 1215-0140.)

2. Withholding. HUD or its designee shall upon its own action or upon written request of an authorized representative of the Department of Labor withhold or cause to be withheld from the contractor under this contract or any other Federal contract with the same prime contractor, or any other Federally-assisted contract subject to Davis-Bacon prevailing wage requirements, which is held by the same prime contractor so much of the accrued payments or advances as may be considered necessary to pay laborers and mechanics, including apprentices, trainees and helpers, employed by the contractor or any subcontractor the full amount of wages required by the contract. In the event of failure to pay any laborer or mechanic, including any apprentice, trainee or helper, employed or working on the site of the work, all or part of the wages required by the contract, HUD or its designee may, after written notice to the contractor, sponsor, applicant, or owner, take such action as may be necessary to cause the suspension of any further payment, advance, or guarantee of funds until such violations have ceased. HUD or its designee may, after written notice to the contractor, disburse such amounts withheld for and on account of the contractor or subcontractor to the respective employees to whom they are due. The Comptroller General shall make such disbursements in the case of direct Davis-Bacon Act contracts.

3. (i) Payrolls and basic records. Payrolls and basic records relating thereto shall be maintained by the contractor during the course of the work preserved for a period of three years thereafter for all laborers and mechanics working at the site of the work. Such records shall contain the name, address, and social security number of each such worker, his or her correct classification, hourly rates of wages paid (including rates of contributions or costs anticipated for bona fide fringe benefits or cash equivalents thereof of the types described in Section I(b)(2)(B) of the Davis-bacon Act), daily and weekly number of hours worked, deductions made and actual wages paid. Whenever the Secretary of Labor has found under 29 CFR 5.5 (a)(1)(iv) that the wages of any laborer or mechanic include the amount of any costs reasonably anticipated in providing benefits under a plan or program described in Section I(b)(2)(B) of the Davis-Bacon Act, the contractor shall maintain records which show that the commitment to provide such benefits is enforceable, that the plan or program is financially responsible, and that the plan or program has been communicated in writing to the laborers or mechanics affected, and records which show the costs anticipated or the actual cost incurred in providing such benefits. Contractors employing apprentices or trainees under approved programs shall maintain written evidence of the registration of apprenticeship programs and certification of trainee programs, the registration of the apprentices and trainees, and the ratios and wage rates prescribed in the applicable programs. (Approved by the Office of Management and Budget under OMB Control Numbers 1215-0140 and 1215-0017.)

(ii) (a) The contractor shall submit weekly for each week in which any contract work is performed a copy of all payrolls to HUD or its designee if the agency is a party to the contract, but if the agency is not such a party, the contractor will submit the payrolls to the applicant sponsor, or owner, as the case may be, for transmission to HUD or its designee. The payrolls submitted shall set out accurately and completely all of the information required to be maintained under 29 CFR 5.5(a)(3)(i). This information may

be submitted in any form desired. Optional Form WH-347 is available for this purpose and may be purchased from the Superintendent of Documents (Federal Stock Number 029-005-00014-1), U.S. Government Printing Office, Washington, DC 20402. The prime contractor is responsible for the submission of copies of payrolls by all subcontractors. (Approved by the Office of Management and Budget under OMB Control Number 1215-0149.)

(b) Each payroll submitted shall be accompanied by a "Statement of Compliance," signed by the contractor or subcontractor or his or her agent who pays or supervises the payment of the persons employed under the contract and shall certify the following:

(1) That the payroll for the payroll period contains the information required to be maintained under 29 CFR 5.5 (a)(3)(i) and that such information is correct and complete;

(2) That each laborer or mechanic (including each helper, apprentice, and trainee) employed on the contract during the payroll period has been paid the full weekly wages earned, without rebate, either directly or indirectly, and that no deductions have been made either directly or indirectly from the full wages earned, other than permissible deductions as set forth in 29 CFR Part 3;

(3) That each laborer or mechanic has been paid not less than the applicable wage rates and fringe benefits or cash equivalents for the classification of work performed, as specified in the applicable wage determination incorporated into the contract.

(c) The weekly submission of a properly executed certification set forth on the reverse side of Optional Form WH-347 shall satisfy the requirement for submission of the "Statement of Compliance" required by subparagraph A.3.(ii)(b).

(d) The falsification of any of the above certifications may subject the contractor or subcontractor to civil or criminal prosecution under Section 1001 of Title 18 and Section 231 of Title 31 of the United States Code.

(iii) The contractor or subcontractor shall make the records required under subparagraph A.3.(i) available for inspection, copying, or transcription by authorized representatives of HUD or its designee or the Department of Labor, and shall permit such representatives to interview employees during working hours on the job. If the contractor or subcontractor fails to submit the required records or to make them available, HUD or its designee may, after written notice to the contractor, sponsor, applicant or owner, take such action as may be necessary to cause the suspension of any further payment, advance, or guarantee of funds. Furthermore, failure to submit the required records upon request or to make such records available may be grounds for debarment action pursuant to 29 CFR 5.12.

4. Apprentices and Trainees.

(i) Apprentices. Apprentices will be permitted to work at less than the predetermined rate for the work they performed when they are employed pursuant to and individually registered in a bona fide apprenticeship program registered with the U.S. Department of Labor, Employment and Training Administration, Office of Apprenticeship Training, Employer and Labor Services, or with a State Apprenticeship Agency recognized by the Office, or if a person is employed in his or her first 90 days of probationary employment as an apprentice in such an apprenticeship program, who is not individually registered in the program, but who has been certified by the Office of Apprenticeship Training, Employer and Labor Services or a State Apprenticeship Agency (where appropriate) to be eligible for probationary employment as an apprentice. The allowable ratio of apprentices to journeymen on the job site in any craft classification shall not be greater than the ratio permitted to the contractor as to the entire work force under the registered program. Any worker listed on a payroll at an apprentice wage rate, who is not registered or otherwise employed as stated above, shall be paid not less than the applicable wage rate on the wage determination for the classification of work actually performed. In addition, any apprentice performing work on the job site in excess of the ratio permitted under the registered program shall be paid not less than the applicable wage rate on the wage determination for the work actually performed. Where a contractor is performing construction on a project in a locality other than that in which its program is registered, the ratios and wage rates (expressed in percentages of the journeyman's hourly rate) specified in the contractor's or subcontractor's registered program shall be observed. Every apprentice must be paid at not less than the rate specified in the registered program for the apprentice's level of progress, expressed as a percentage of the journeymen hourly rate specified in the applicable wage determination. Apprentices shall be paid fringe benefits in accordance with the provisions of the apprenticeship program. If the apprenticeship program does not specify fringe benefits, apprentices must be paid the full amount of fringe benefits listed on the wage determination for the applicable classification. If the Administrator determines that a different practice prevails for the applicable apprentice classification, fringes shall be paid in accordance with that determination. In the event the Office of Apprenticeship Training, Employer and Labor Services, or a State Apprenticeship Agency recognized by the Office, withdraws approval of an apprenticeship program, the contractor will no longer be permitted to utilize apprentices at less than the applicable predetermined rate for the work performed until an acceptable program is approved.

(ii) Trainees. Except as provided in 29 CFR 5.16, trainees will not be permitted to work at less than the predetermined rate for the work performed unless they are employed pursuant to and individually registered in a program which has received prior approval, evidenced by formal certification by the U.S. Department of Labor, Employment and Training Administration. The ratio of trainees to journeymen on the job site shall not be greater than permitted under the plan approved by the Employment and Training Administration. Every trainee must be paid at not less than the rate specified in the approved program for the trainee's level of progress, expressed as a percentage of the journeyman hourly rate specified in the applicable wage determination. Trainees shall be paid fringe benefits in accordance with the provisions of the trainee program. If the trainee program does not mention fringe benefits, trainees shall be paid the full amount

of fringe benefits listed on the wage determination unless the Administrator of the Wage and Hour Division determines that there is an apprenticeship program associated with the corresponding journeyman wage rate on the wage determination which provides for less than full fringe benefits for apprentices. Any employee listed on the payroll at a trainee rate who is not registered and participating in a training plan approved by the Employment and Training Administration shall be paid not less than the applicable wage rate on the wage determination for the work actually performed. In addition, any trainee performing work on the job site in excess of the ratio permitted under the registered program shall be paid not less than the applicable wage rate on the wage determination for the work actually performed. In the event the Employment and Training Administration withdraws approval of a training program, the contractor will no longer be permitted to utilize trainees at less than the applicable predetermined rate for the work performed until an acceptable program is approved.

(iii) Equal employment opportunity. The utilization of apprentices, trainees and journeymen under 29 CFR Part 5 shall be in conformity with the equal employment opportunity requirements of Executive Order 11246, as amended, and 29 CFR Part 30.

5. Compliance with Copeland Act requirements. The contractor shall comply with the requirements of 29 CFR Part 3 which are incorporated by reference in this contract

6. Subcontracts. The contractor or subcontractor will insert in any subcontracts the clauses contained in subparagraphs 1 through 11 of this paragraph A and such other clauses as HUD or its designee may by appropriate instructions require, and a copy of the applicable prevailing wage decision, and also a clause requiring the subcontractors to include these clauses in any lower tier subcontracts. The prime contractor shall be responsible for the compliance by any subcontractor or lower tier subcontractor with all the contract clauses in this paragraph.

7. Contract termination; debarment. A breach of the contract clauses in 29 CFR 5.5 may be grounds for termination of the contract and for debarment as a contractor and a subcontractor as provided in 29 CFR 5.12.

8. Compliance with Davis-Bacon and Related Act Requirements. All rulings and interpretations of the Davis-Bacon and Related Acts contained in 29 CFR Parts 1, 3, and 5 are herein incorporated by reference in this contract.

9. Disputes concerning labor standards. Disputes arising out of the labor standards provisions of this contract shall not be subject to the general disputes clause of this contract. Such disputes shall be resolved in accordance with the procedures of the Department of Labor set forth in 29 CFR Parts 5, 6, and 7. Disputes within the meaning of this clause include disputes between the contractor (or any of its subcontractors) and HUD or its designee, the U.S. Department of Labor, or the employees or their representatives.

10. (i) Certification of Eligibility. By entering into this contract the contractor certifies that neither it (nor he or she) nor any person or firm who has an interest in the contractor's firm is a person or firm ineligible to be awarded Government contracts by virtue of Section 3(a) of the Davis-Bacon Act or 29 CFR 5.12(a)(1) or to be awarded HUD contracts or participate in HUD programs pursuant to 24 CFR Part 24.

(ii) No part of this contract shall be subcontracted to any person or firm ineligible for award of a Government contract by virtue of Section 3(a) of the Davis-Bacon Act or 29 CFR 5.12(a)(1) or to be awarded HUD contracts or participate in HUD programs pursuant to 24 CFR Part 24.

(iii) The penalty for making false statements is prescribed in the U.S. Criminal Code, 18 U.S.C. 1001. Additionally, U.S. Criminal Code, Section 1010, Title 18, U.S.C., "Federal Housing Administration transactions", provides in part: "Whoever, for the purpose of . . . influencing in any way the action of such Administration..... makes, utters or publishes any statement knowing the same to be false..... shall be fined not more than \$5,000 or imprisoned not more than two years, or both."

11. Complaints, Proceedings, or Testimony by Employees. No laborer or mechanic to whom the wage, salary, or other labor standards provisions of this Contract are applicable shall be discharged or in any other manner discriminated against by the Contractor or any subcontractor because such employee has filed any complaint or instituted or caused to be instituted any proceeding or has testified or is about to testify in any proceeding under or relating to the labor standards applicable under this Contract to his employer.

B. Contract Work Hours and Safety Standards Act. The provisions of this paragraph B are applicable only where the amount of the prime contract exceeds \$100,000. As used in this paragraph, the terms "laborers" and "mechanics" include watchmen and guards.

(1) Overtime requirements. No contractor or subcontractor contracting for any part of the contract work which may require or involve the employment of laborers or mechanics shall require or permit any such laborer or mechanic in any workweek in which he or she is employed on such work to work in excess of 40 hours in such workweek unless such laborer or mechanic receives compensation at a rate not less than one and one-half times the basic rate of pay for all hours worked in excess of 40 hours in such workweek.

(2) Violation; liability for unpaid wages; liquidated damages. In the event of any violation of the clause set forth in subparagraph (1) of this paragraph, the contractor and any subcontractor responsible therefor shall be liable for the unpaid wages. In addition, such contractor and subcontractor shall be liable to the United States (in the case of work done under contract for the District of Columbia or a territory, to such District or to such territory), for liquidated damages. Such liquidated damages shall be computed

with respect to each individual laborer or mechanic, including watchmen and guards, employed in violation of the clause set forth in subparagraph (1) of this paragraph, in the sum of \$10 for each calendar day on which such individual was required or permitted to work in excess of the standard workweek of 40 hours without payment of the overtime wages required by the clause set forth in sub paragraph (1) of this paragraph.

(3) Withholding for unpaid wages and liquidated damages. HUD or its designee shall upon its own action or upon written request of an authorized representative of the Department of Labor withhold or cause to be withheld, from any moneys payable on account of work performed by the contractor or subcontractor under any such contract or any other Federal contract with the same prime contract, or any other Federally-assisted contract subject to the Contract Work Hours and Safety Standards Act which is held by the same prime contractor such sums as may be determined to be necessary to satisfy any liabilities of such contractor or subcontractor for unpaid wages and liquidated damages as provided in the clause set forth in subparagraph (2) of this paragraph.

(4) Subcontracts. The contractor or subcontractor shall insert in any subcontracts the clauses set forth in subparagraph (1) through (4) of this paragraph and also a clause requiring the subcontractors to include these clauses in any lower tier subcontracts. The prime contractor shall be responsible for compliance by any subcontractor or lower tier subcontractor with the clauses set forth in subparagraphs (1) through (4) of this paragraph.

C. Health and Safety. The provisions of this paragraph C are applicable only where the amount of the prime contract exceeds \$100,000.

(1) No laborer or mechanic shall be required to work in surroundings or under working conditions which are unsanitary, hazardous, or dangerous to his health and safety as determined under construction safety and health standards promulgated by the Secretary of Labor by regulation.

(2) The Contractor shall comply with all regulations issued by the Secretary of Labor pursuant to Title 29 Part 1926 and failure to comply may result in imposition of sanctions pursuant to the Contract Work Hours and Safety Standards Act, 40 USC 3701 et seq.

(3) The Contractor shall include the provisions of this paragraph in every subcontract so that such provisions will be binding on each subcontractor. The Contractor shall take such action with respect to any subcontract as the Secretary of Housing and Urban Development or the Secretary of Labor shall direct as a means of enforcing such provisions.

form HUD-4010 (07/2003) Previous edition is obsolete.

ref. Handbook 1344.1

APPENDIX C
FEDERAL WAGE DETERMINATION

General Decision Number: LA130006 01/18/2013 LA6

Superseded General Decision Number: LA20120006

State: Louisiana

Construction Type: Heavy

Counties: Allen, Assumption, Avoyelles, Beauregard, Bienville, Caldwell, Cameron, Catahoula, Claiborne, Concordia, De Soto, East Carroll, East Feliciana, Evangeline, Franklin, Grant, Iberia, Iberville, Jackson, Jefferson Davis, La Salle, Lincoln, Madison, Morehouse, Natchitoches, Pointe Coupee, Red River, Richland, Sabine, St Helena, St Mary, Tangipahoa, Tensas, Union, Vermilion, Vernon, Washington, West Carroll, West Feliciana and Winn Counties in Louisiana.

HEAVY CONSTRUCTION PROJECTS (includes water wells, water & sewer lines, and flood control; excludes elevated storage tanks)

Modification Number	Publication Date
0	01/04/2013
1	01/18/2013

ELEC0130-007 12/01/2012

ASSUMPTION AND ST. MARY (Northeast of Atchafalaya River) PARISHES

	Rates	Fringes
ELECTRICIAN.....	\$ 28.50	9.24

ELEC0194-006 09/03/2012

BIENVILLE, CLAIBORNE, DE SOTO, NATCHITOCHEs (Northeast of the Red River), and RED RIVER PARISHES

	Rates	Fringes
ELECTRICIAN Lineman and Heavy Equipment Operator.....	\$ 25.25	9.56

* ELEC0446-004 01/01/2013

CALDWELL, EAST CARROLL, FRANKLIN, JACKSON, LINCOLN, MADISON, MOREHOUSE, RICHLAND, TENSAS, UNION, and WEST CARROLL PARISHES

	Rates	Fringes
ELECTRICIAN.....	\$ 21.40	1%+9.23

ELEC0576-002 09/01/2012

AVOYELLES, CATAHOULA, CONCORDIA, EVANGELINE, GRANT, LA SALLE,
NATCHITOCHE (Southwest of Red River), SABINE, VERNON, AND WINN
PARISHES

	Rates	Fringes
ELECTRICIAN.....	\$ 23.50	4.25%+5.60

ELEC0861-004 09/01/2011

ALLEN, BEAUREGARD, CAMERON, IBERIA, JEFFERSON DAVIS, ST. MARY
(Southwest of Atchafalaya River), AND VERMILION PARISHES

	Rates	Fringes
ELECTRICIAN.....	\$ 23.90	4%+9.69

ELEC0995-002 01/01/2012

EAST FELICIANA, IBERVILLE, POINTE COUPEE, ST. HELENA, AND WEST
FELICIANA PARISHES

	Rates	Fringes
ELECTRICIAN.....	\$ 22.68	8.82

ELEC1077-005 09/01/2012

TANGIPAHOA and WASHINGTON PARISHES

	Rates	Fringes
ELECTRICIAN.....	\$ 22.50	7.17

SULA2004-008 05/19/2004

	Rates	Fringes
CARPENTER (including formsetting/formbuilding).....	\$ 14.75	0.00

Laborers:

Common.....	\$ 7.60	0.00
Pipelayer.....	\$ 8.47	0.00

PIPEFITTER (excluding pipelaying).....	\$ 18.75	4.05
---	----------	------

Power equipment operators:

Backhoe/Excavator.....	\$ 11.67	0.00
Boring Machine.....	\$ 10.25	0.00
Bulldozer.....	\$ 11.82	0.00
Crane.....	\$ 13.60	0.00
Dragline.....	\$ 13.12	0.00
Front End Loader.....	\$ 9.93	0.00
Mechanic.....	\$ 12.50	0.00
Trackhoe.....	\$ 11.99	0.00

Tractor.....	\$ 10.43	0.00
Water Well Driller.....	\$ 10.73	2.01

Truck drivers:

Dump.....	\$ 10.00	0.00
Water.....	\$ 8.00	0.00

WELDERS - Receive rate prescribed for craft performing operation to which welding is incidental.

=====

Unlisted classifications needed for work not included within the scope of the classifications listed may be added after award only as provided in the labor standards contract clauses (29CFR 5.5 (a) (1) (ii)).

The body of each wage determination lists the classification and wage rates that have been found to be prevailing for the cited type(s) of construction in the area covered by the wage determination. The classifications are listed in alphabetical order of "identifiers" that indicate whether the particular rate is union or non-union.

Union Identifiers

An identifier enclosed in dotted lines beginning with characters other than "SU" denotes that the union classification and rate have found to be prevailing for that classification. Example: PLUM0198-005 07/01/2011. The first four letters , PLUM, indicate the international union and the four-digit number, 0198, that follows indicates the local union number or district council number where applicable , i.e., Plumbers Local 0198. The next number, 005 in the example, is an internal number used in processing the wage determination. The date, 07/01/2011, following these characters is the effective date of the most current negotiated rate/collective bargaining agreement which would be July 1, 2011 in the above example.

Union prevailing wage rates will be updated to reflect any changes in the collective bargaining agreements governing the rates.

0000/9999: weighted union wage rates will be published annually each January.

Non-Union Identifiers

Classifications listed under an "SU" identifier were derived from survey data by computing average rates and are not union

rates; however, the data used in computing these rates may include both union and non-union data. Example: SULA2004-007 5/13/2010. SU indicates the rates are not union majority rates, LA indicates the State of Louisiana; 2004 is the year of the survey; and 007 is an internal number used in producing the wage determination. A 1993 or later date, 5/13/2010, indicates the classifications and rates under that identifier were issued as a General Wage Determination on that date.

Survey wage rates will remain in effect and will not change until a new survey is conducted.

WAGE DETERMINATION APPEALS PROCESS

1.) Has there been an initial decision in the matter? This can be:

- * an existing published wage determination
- * a survey underlying a wage determination
- * a Wage and Hour Division letter setting forth a position on a wage determination matter
- * a conformance (additional classification and rate) ruling

On survey related matters, initial contact, including requests for summaries of surveys, should be with the Wage and Hour Regional Office for the area in which the survey was conducted because those Regional Offices have responsibility for the Davis-Bacon survey program. If the response from this initial contact is not satisfactory, then the process described in 2.) and 3.) should be followed.

With regard to any other matter not yet ripe for the formal process described here, initial contact should be with the Branch of Construction Wage Determinations. Write to:

Branch of Construction Wage Determinations
Wage and Hour Division
U.S. Department of Labor
200 Constitution Avenue, N.W.
Washington, DC 20210

2.) If the answer to the question in 1.) is yes, then an interested party (those affected by the action) can request review and reconsideration from the Wage and Hour Administrator (See 29 CFR Part 1.8 and 29 CFR Part 7). Write to:

Wage and Hour Administrator
U.S. Department of Labor
200 Constitution Avenue, N.W.
Washington, DC 20210

The request should be accompanied by a full statement of the interested party's position and by any information (wage payment data, project description, area practice material, etc.) that the requestor considers relevant to the issue.

3.) If the decision of the Administrator is not favorable, an

interested party may appeal directly to the Administrative Review Board (formerly the Wage Appeals Board). Write to:

Administrative Review Board
U.S. Department of Labor
200 Constitution Avenue, N.W.
Washington, DC 20210

4.) All decisions by the Administrative Review Board are final.

=====

END OF GENERAL DECISION

APPENDIX D
OWNER OBTAINED PERMITS



**DEPARTMENT OF NATURAL RESOURCES
OFFICE OF COASTAL MANAGEMENT**

P.O. BOX 44487
BATON ROUGE, LOUISIANA 70804-4487
(225)342-7591
1-800-267-4019

COASTAL USE PERMIT/CONSISTENCY DETERMINATION

C.U.P. No.: P20100053 (Extended, Revised)

C.O.E. No.: MVN- 2010- 00265

NAME: **ST. MARY LEVEE DISTRICT**
c/o MILLER ENGINEERS & ASSOCIATES, INC.
P.O. BOX 223
FRANKLIN, LA 70538
Attn: Reid A. Miller

LOCATION: **Saint Mary Parish, LA**
Lat 29° 47' 06.2"N / Long -91° 31' 38.3"W (North End of Levee); Lat 29° 47' 02.7"N / Long -91° 31' 42.3"W (South End of Levee - riprap on bank); Section 63 T14S R9E; Franklin, 70538

DESCRIPTION: Proposed construction of a flood protection levee and a navigable waterway control structure on the Franklin Canal. A 784' x 71' x 1' deep max (1.2 acres) area will be excavated (1,945 cubic yards) to remove organic material to improve the base foundation for the levee. The levee is comprised of a 784' x 56' x 7' high (max) earthen material section, two (2) sections of rip-rap totaling 80' x 55' x 8' high (max), a section of cantilever steel sheet pile measuring 172' x 9.5' high (above ground surface; -30' below ground surface) and one (1) 40' x 20' deep moveable cut-off wall (for marine traffic passage) located in the center of the Franklin canal between the sheet pile section. Ten (10) five (5) pile mooring, two (2) breasting dolphins and a walkway will be located on both sides of the sheet pile section in the Franklin Canal. Approximately 0.07 acres (310 cubic yards) of non-vegetated waterbottoms will be excavated for placement of rip-rap. Approximately 1.1 acres of land area will be filled with earthen material (8,750 cubic yards) and rip-rap (170 cubic yards); 0.07 acres of non-vegetated waterbottoms will be filled with rip-rap (267 cubic yards) for scour protection.

REVISION 1: Revisions include additional excavation (1,675 cubic yards), filling (1,282 cubic yards of riprap) of approximately 0.4 acres of waterbottom and installation of a pump station on pile foundation.

This extended, revised permit supersedes the original permit which was issued June 3, 2010.

In accordance with the rules and regulations of the Louisiana Coastal Resources Program and Louisiana R.S. 49, Sections 214.21 to 214.41, the State and Local Coastal Resources Management Act of 1978, as amended, the permittee agrees to:

1. Carry out, perform, and/or operate the use in accordance with the permit conditions, plans and specifications approved by the Department of Natural Resources.
2. Comply with any permit conditions imposed by the Department of Natural Resources.
3. Adjust, alter or remove any structure or other physical evidence of the permitted use if, in the opinion of the Department of Natural Resources, it proves to be beyond the scope of the use as approved or is abandoned.
4. Provide, if required by the Department of Natural Resources, an acceptable surety bond in an appropriate amount to ensure adjustment, alteration, or removal should the Department of Natural Resources determine it necessary.
5. Hold and save the State of Louisiana, the local government, the department, and their officers and employees harmless from any damage to persons or property which might result from the use, including the work, activity, or structure permitted.
6. Certify that the use has been completed in an acceptable and satisfactory manner and in accordance with the plans and specifications approved by the Department of Natural Resources. The Department of Natural Resources may, when appropriate, require such certification to be given by a registered professional engineer.
7. All terms of the permit shall be subject to all applicable federal and state laws and regulations.
8. This extended, revised permit, or a copy thereof, shall be available for inspection at the site of work at all times during operations.
9. The applicant will notify the Office of Coastal Management of the date on which initiation of the permitted activity described under the "Coastal Use Description" began. The applicant shall notify the Office of Coastal Management by mailing the enclosed green initiation card on the date of initiation of the coastal use.
10. Unless specified elsewhere in this extended, revised permit, this extended, revised permit authorizes the initiation of the coastal use described under "Coastal Use Description" for four (4) years from the date of the signature of the Secretary or his designee on the original permit which was June 3, 2010. If the coastal use is not initiated within this four (4) year period, then this extended, revised permit will expire and the applicant will be required to submit a new application. Initiation of the coastal



use, for the purposes of this permit, means the actual physical beginning of the use of activity for which the permit is required. Initiation does not include preparatory activities, such as movement of equipment onto the coastal use site, expenditure of funds, contracting out of work, or performing activities which by themselves do not require a permit. In addition, the permittee must, in good faith, and with due diligence, reasonably progress toward completion of the project once the coastal use has been initiated.

11. The following special conditions must also be met in order for the use to meet the guidelines of the Coastal Resources Program:

- a. This extended, revised permit does not convey any property rights, mineral rights, or exclusive privileges; nor does it authorize injury to property.
- b. Permittee shall, prior to commencement of the herein permitted activities, contact Rhonda Braud (phone: 225-342-4553, email: rhonda.braud@la.gov) to determine if a construction permit will be required from the local levee district.
- c. All logs, stumps and other debris unearthed during dredging shall be removed to an approved disposal site on land.
- d. That permittee shall insure that all sanitary sewage and/or related domestic wastes generated during the subject project activity and at the site, thereafter, as may become necessary shall receive the equivalent of secondary treatment (30 mg/l BOD5) with disinfection prior to discharge into any of the streams or adjacent waters of the area or, in the case of total containment, shall be disposed of in approved sewerage and sewage treatment facilities, as is required by the State Sanitary Code. Such opinion as may be served by those comments offered herein shall not be construed to suffice as any more formal approval(s) which may be required of possible sanitary details (i.e. provisions) scheduled to be associated with the subject activity. Such shall generally require that appropriate plans and specifications be submitted to the Department of Health and Hospitals for purpose of review and approval prior to any utilization of such provisions.
- e. The area where the project is located is all part of the aboriginal homelands of the Chitimacha Tribe of Louisiana. As such, large villages, burial sites, and sacred sites were in place in that entire area. If at any time during the course of the work, any traditional cultural properties are discovered, Permittee shall immediately contact Kimberly S. Walden (Cultural Director) or Melanie Aymond (Research Coordinator) at (337) 923-9923 or (337) 923-4395. Office hours are Monday through Thursday from 7:30 A.M. - 5:00 P.M. and on Friday between 7:30 A.M. - 11:30 A.M. If traditional cultural properties are discovered on the weekend or after business hours, the notification shall be made the next business morning.
- f. That should changes in the location or the section of the existing waterways, or in the generally prevailing conditions in the vicinity be required in the future, in the public interest, Permittee shall make such changes in the project concerned or in the arrangement thereof as may be necessary to satisfactorily meet the situation and shall bear the cost thereof. This condition does not preclude the necessity for revising the current permit or obtaining a separate Coastal Use Permit, should one be required, for project modifications.
- g. This project occurs adjacent to the boundary of Bayou Teche Wildlife Management Area. Prior to any applications for federal and/or state permits please contact Paul Yakupzack at (337) 828-0092 to coordinate these activities as related to the Bayou Teche WMA.
- h. Permittee shall insure that the large oak trees near and/or within the project area are not destroyed, damaged or adversely impacted resulting from construction activities to the maximum extent practicable.
- i. Permittee shall implement adequate erosion/sediment control measures such as the proper use of vegetated buffers, silt fences or other Environmental Protection Agency construction site stormwater runoff control best management practices to insure that no sediments or other activity related debris are allowed to enter waters of the State.



- j. No other impacts to rare, threatened or endangered species or critical habitats are anticipated from the proposed project. No state or federal parks, wildlife refuges, wildlife management areas or scenic rivers are known at the specified site or within ¼ mile of the proposed project.

The Louisiana Natural Heritage Program (LNHP) has compiled data on rare, endangered, or otherwise significant plant and animal species, plant communities, and other natural features throughout the State of Louisiana. LNHP reports summarize the existing information known at the time of the request regarding the location in question. LNHP reports should not be considered final statements on the biological elements or areas being considered, nor should they be substituted for on-site surveys required for environmental assessments. If at any time LNHP tracked species are encountered within the project area, please contact our biologist at 225-765-2643.

- k. The Louisiana black bear (*Ursus americanus luteolus*) may occur in your general project area. It is listed as threatened under the Endangered Species Act. The Louisiana black bear utilizes a variety of habitat types, including forested wetlands, marsh, spoil banks, and upland forests. The primary threats to the species are the continued loss of bottomland hardwoods, fragmentation of remaining forested tracts, and human-caused mortality. Louisiana black bears, particularly pregnant females, normally den from December through April. Bald cypress (*Taxodium distichum*) and tupelo gum (*Nyssa sp.*) with visible cavities, having a diameter at breast height of 36 inches or greater, and occurring in or along rivers, lakes, streams, bayous, sloughs, or other water bodies have legal protection as candidate or actual den trees. If construction is to be performed during the denning season or if bald cypress or tupelo gum with diameters at breast height of 36 inches or greater will be removed or destroyed, further consultation with this office will be necessary. We strongly urge workers and contractors to avoid bears, particularly if work is to be conducted during the non-denning season (April through December). Employees should be cautioned not to leave food or garbage in the field, as bears can become attracted and accustomed to human food easily. In addition, use of bear proof garbage containers on site is recommended. If you have any questions, please call Maria Davidson at (337) 948-0255.
- l. Permittee shall, prior to commencement of the herein permitted activities, contact Rhonda Braud (phone: 225-342-4553, email: rhonda.braud@la.gov) to determine if a construction permit will be required from the local levee district.
- m. Permittee is subject to all applicable state laws related to damages which are demonstrated to have been caused by this action.
- n. Permittee shall allow representatives of the Office of Coastal Management or authorized agents to make periodic, unannounced inspections to assure the activity being performed is in accordance with the conditions of this permit.
- o. Permittee shall comply with all applicable state laws regarding the need to contact the Louisiana One Call (LOC) system (1-800-272-3020) to locate any buried cables and pipelines.
- p. This extended, revised permit authorizes the initiation of the Coastal Use described under "Coastal Use Description" for four (4) years from the date of the signature of the Secretary or his designee on the original permit which was June 3, 2010. Initiation of the Coastal Use, for purposes of this extended, revised permit, means the actual physical beginning of the use or activity for which the permit is required. Initiation does not include preparatory activities, such as movement of equipment onto the Coastal Use site, expenditure of funds, contracting out of work, or performing activities which by themselves do not require a permit. In addition, Permittee must, in good faith and with due diligence, reasonably progress toward completion of the project once the Coastal Use has been initiated.

The expiration date of this extended, revised permit is five (5) years from the date of the signature of the Secretary or his designee on the original permit which was June 3, 2010.

Upon expiration of this extended, revised permit, a new Coastal Use Permit will be required for completion of any unfinished or uncommenced work items and for any maintenance activities involving dredging or fill that may become



necessary. Other types of maintenance activities may also require a new Coastal Use Permit.

***** End of Conditions *****

By accepting this extended, revised permit the applicant agrees to its terms and conditions.

I affix my signature and issue this extended, revised permit this 24th day of May, 2013.

THE DEPARTMENT OF NATURAL RESOURCES

Karl L. Morgan, Administrator
Office of Coastal Management

This agreement becomes binding when signed by Administrator of the Office of Coastal Management Permits/Mitigation Division, Department of Natural Resources.

Attachments

Page: 5 of 5

C.U.P. No.: P20100053 (Extended, Revised)

C.O.E. No.: MVN- 2010- 00265



Final Plats:

1) [P20100053](#) [Final Plats](#) [02/04/2013](#)

cc: Martin Mayer, COE w/attachments
Dave Butler, LDWF w/attachments
Jessica Diez, OCM w/attachments
Darin Thomasee, OCM/FI w/attachments

ST. MARY LEVEE DISTRICT w/attachments



DEPARTMENT OF THE ARMY

NEW ORLEANS DISTRICT, CORPS OF ENGINEERS

P. O. BOX 60267

NEW ORLEANS, LOUISIANA 70160-0267

REPLY TO ATTENTION OF:

Operations Division
Western Evaluation Section

DEC 23 2013

SUBJECT: MVN-2010-0265-WJJ

St. Mary Levee District
Attn: William H. Hidalgo
800 Youngs Road
Morgan City, Louisiana 70381

Dear Mr. Hidalgo:

Revised drawings attached in five (5) sheets, furnished with your application dated February 4, 2013, requesting authorization for the following revision: additional excavation (approximately 1,675 cubic yards) and filling (approximately 1280 cubic yards of riprap) of approximately 0.4 acres of waterbottom and installation of a pump station on pile foundation, located on the flood side of the Tech Ridge levee (East of Franklin Canal levee), in Franklin, Louisiana, in St. Mary Parish (29.78408, -91.52842), are approved and will be included in your plans for the work authorized by the Secretary of the Army in a permit dated December 3, 2010, with the following additional special conditions:

- 1) Pile driving is to be performed and completed and excavations are to be performed and backfilled when the stage of the Mississippi River is below elevation +11.0 feet on the Carrollton gage, at New Orleans, Louisiana.
- 2) All open excavations need to be backfilled to natural ground prior to river stage reaching +11.0 feet on the Carrollton gage.
- 3) Any disturbed areas on the levee during construction are to be restored to the pre-existing conditions, including fertilizing and seeding.
- 4) Any damage to the levee resulting from permittee activities is to be repaired at the permittee's expense.

The conditions, to which the work is made subject, remain in full force and effect.

A copy of the first page of this permit approval letter must be conspicuously displayed at the project site. Also, you must keep a copy of this signed letter, with attached drawings, at the project site until the work is completed.

BY AUTHORITY OF THE SECRETARY OF THE ARMY:



Martin S. Mayer
Chief, Regulatory Branch
for
Richard L. Hansen
Colonel, U.S. Army
District Commander

Enclosures

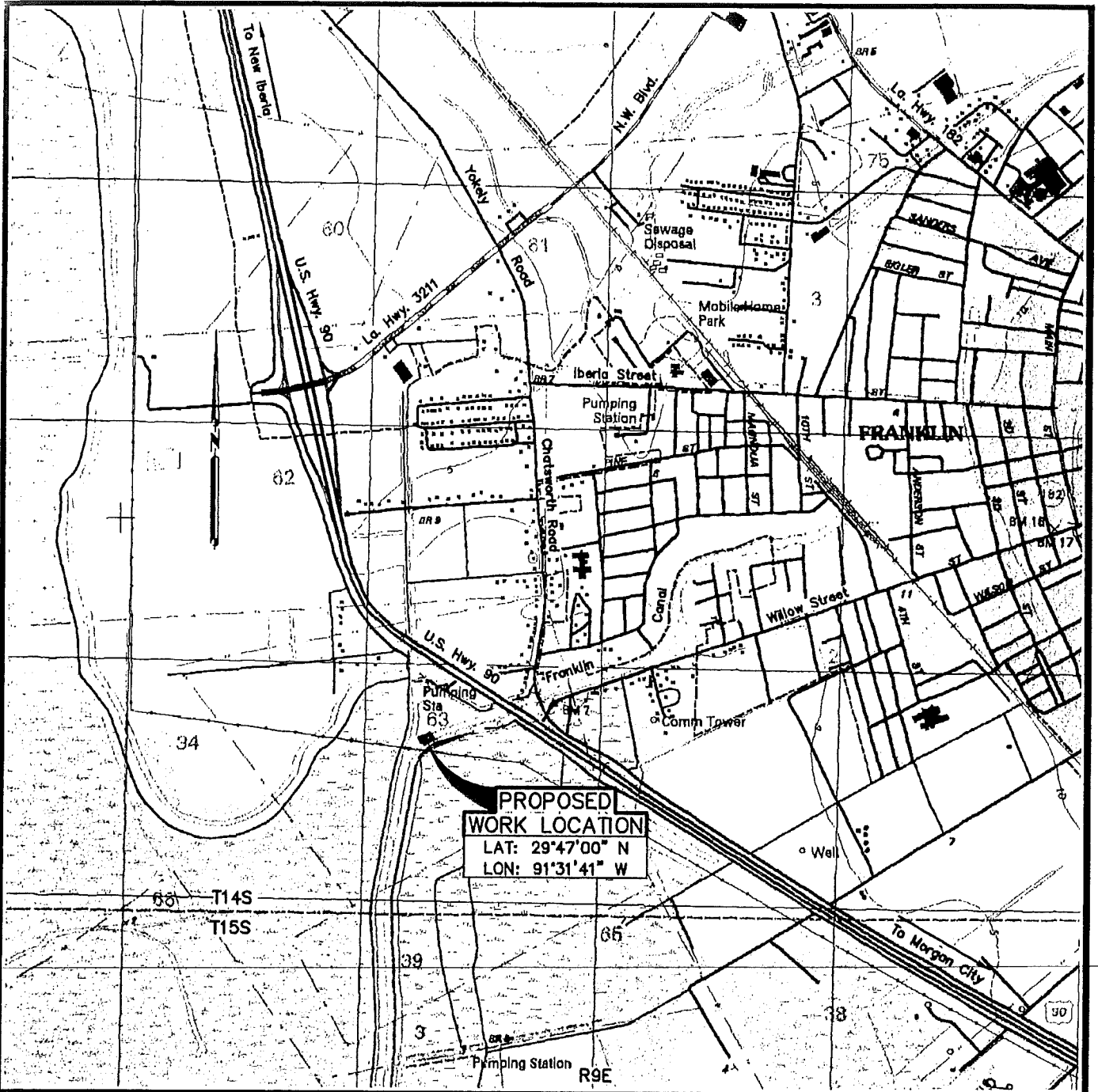

VICINITY MAP

Scale:
 2000' 1000' 0' 2000'

Copied From U.S.C. & G.S. Quadrangle
 Franklin, Louisiana 1995

PROPOSED: FRANKLIN CANAL FLOOD PROTECTION SYSTEM
 ON: FRANKLIN CANAL
 SITUATED IN: SECTION 63 T14S-R9E,
 ST. MARY PARISH, LOUISIANA
 APPLICATION BY: ST. MARY
 LEVEE DISTRICT
 DATE: JANUARY 2, 2013

REVISED: JANUARY 28, 2013 TO SHOWN SHEET NUMBER CHANGE.

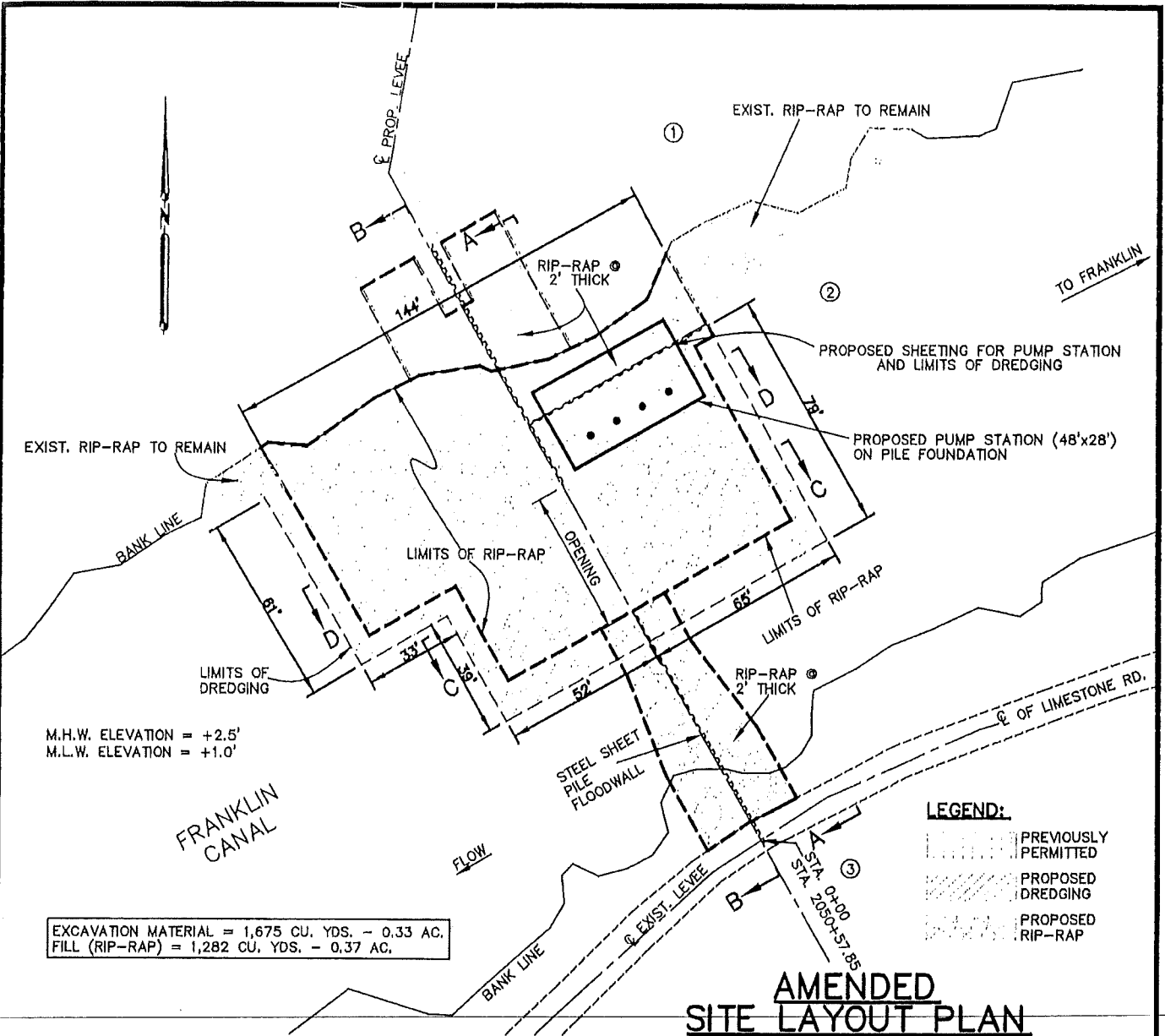

M.H.W. ELEVATION = +2.5'
M.L.W. ELEVATION = +1.0'

EXCAVATION MATERIAL = 1,675 CU. YDS. - 0.33 AC.
FILL (RIP-RAP) = 1,282 CU. YDS. - 0.37 AC.

- LEGEND:**
- PREVIOUSLY PERMITTED
 - PROPOSED DREDGING
 - PROPOSED RIP-RAP

**AMENDED
SITE LAYOUT PLAN**

SCALE:
50' 25' 0' 50'

- NOTES:**
1. LEVEE AND CLOSURE STRUCTURE (SHEET PILE, RECEIVING STRUCTURE, BARGE, ETC.) WERE PREVIOUSLY PERMITTED UNDER THE FOLLOWING PERMITS:
CUP - P20100053, COE - MVN-2010-00265
 2. BARGE, PILES, PIVOT ARM, WALKWAY, ETC. NOT SHOWN ON THIS DRAWING FOR CLARITY.
 3. DREDGED MATERIAL WILL BE REMOVED FROM PROJECT SITE AND DISPOSED OF IN ACCORDANCE WITH APPLICABLE LAWS.

REVISED: JANUARY 28, 2013 TO SHOW SHEET NUMBER CHANGE AND ADDED LEGEND FOR DIFFERENT ITEMS.
REVISED: JANUARY 29, 2013 TO ADDRESS ADDITIONAL COMMENTS FROM O.C.M.

ADJACENT PROPERTY OWNERS:

- ① GREG PONTIFF
2408 CHATSWORTH ROAD
FRANKLIN, LA. 70538
- ② CAFFERY ESTATE
15500 LA. HWY. 182
FRANKLIN, LA. 70538
- ③ UNITED STATES OF AMERICA
NATIONAL WILDLIFE REFUGE
1875 CENTURY BLVD. SUITE 420
ATLANTA, GA. 30345

**PROPOSED: FRANKLIN CANAL FLOOD
PROTECTION SYSTEM**
ON: FRANKLIN CANAL
SITUATED IN: SECTION 63 T14S-R9E,
ST. MARY PARISH, LOUISIANA
APPLICATION BY: ST. MARY
LEVEE DISTRICT
DATE: JANUARY 2, 2013

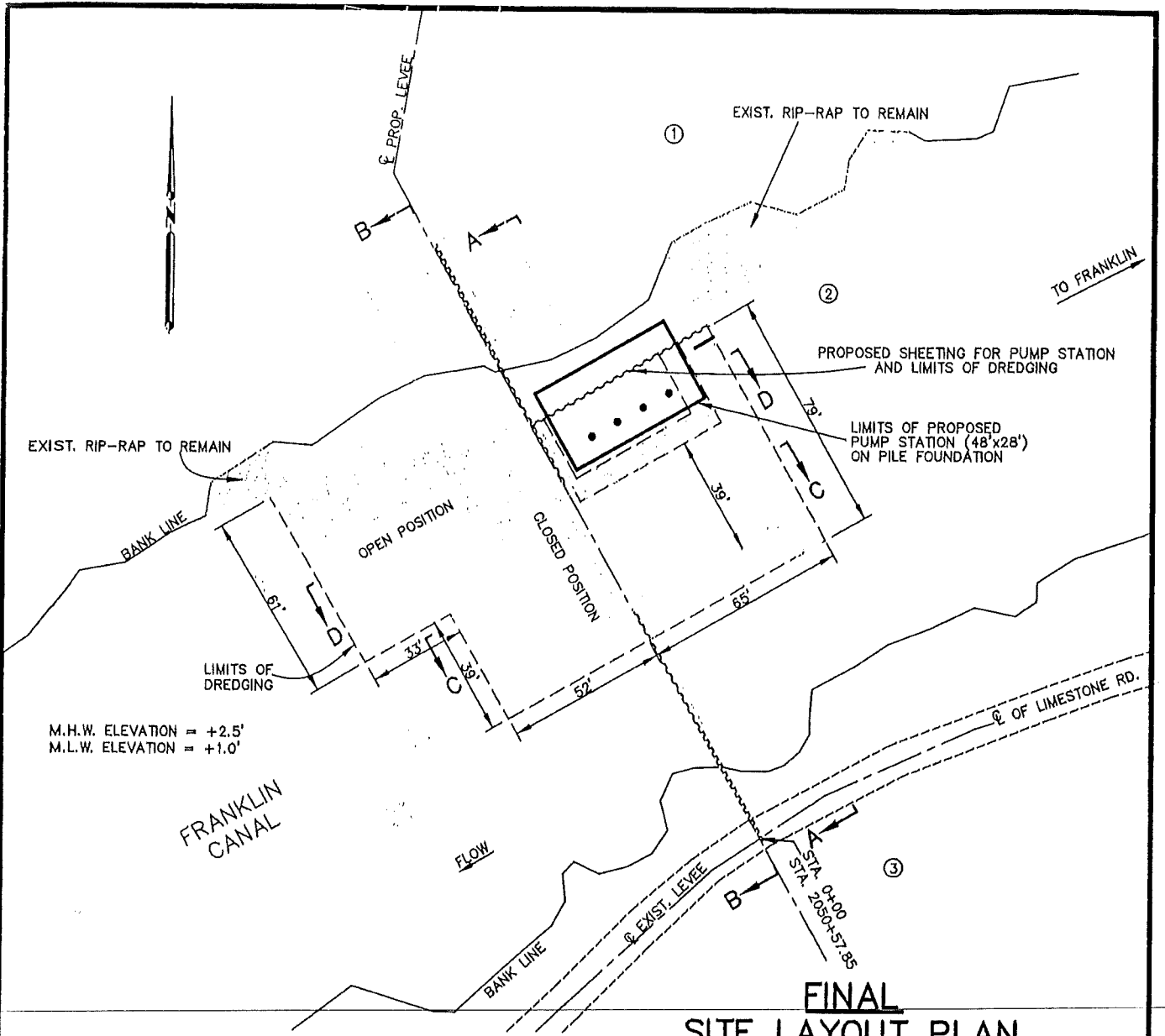

M.H.W. ELEVATION = +2.5'
M.L.W. ELEVATION = +1.0'

FINAL SITE LAYOUT PLAN

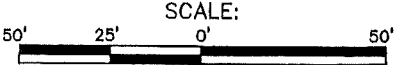

REVISED: JANUARY 29, 2013 TO ADDRESS ADDITIONAL COMMENTS FROM O.C.M.

PROPOSED: FRANKLIN CANAL FLOOD PROTECTION SYSTEM
ON: FRANKLIN CANAL
SITUATED IN: SECTION 63 T14S-R9E,
ST. MARY PARISH, LOUISIANA
APPLICATION BY: ST. MARY LEVEE DISTRICT
DATE: JANUARY 28, 2013
SHEET 3 OF 5

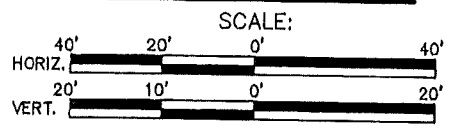
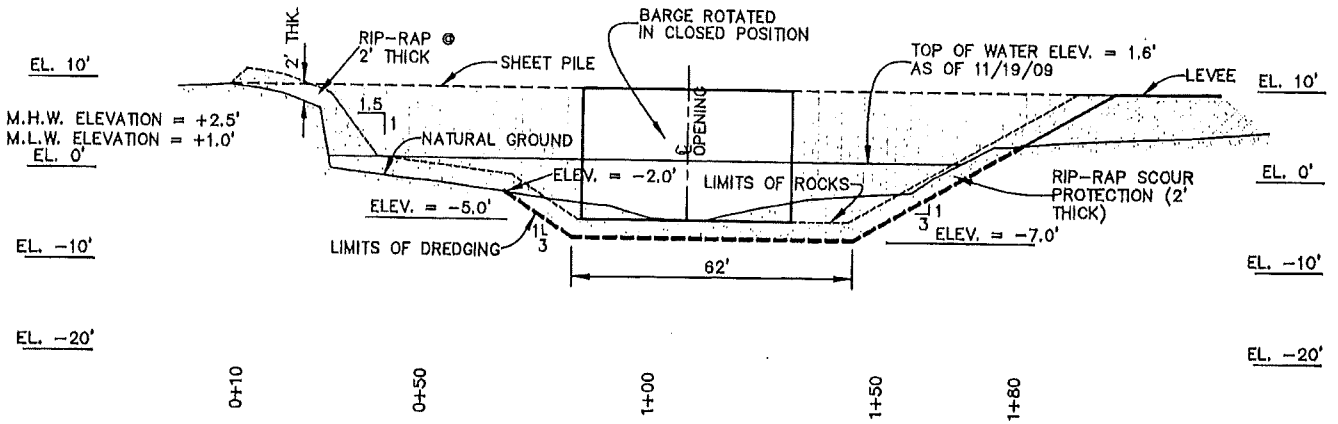
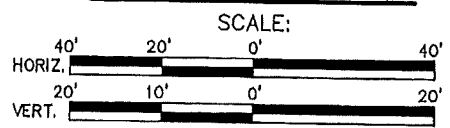
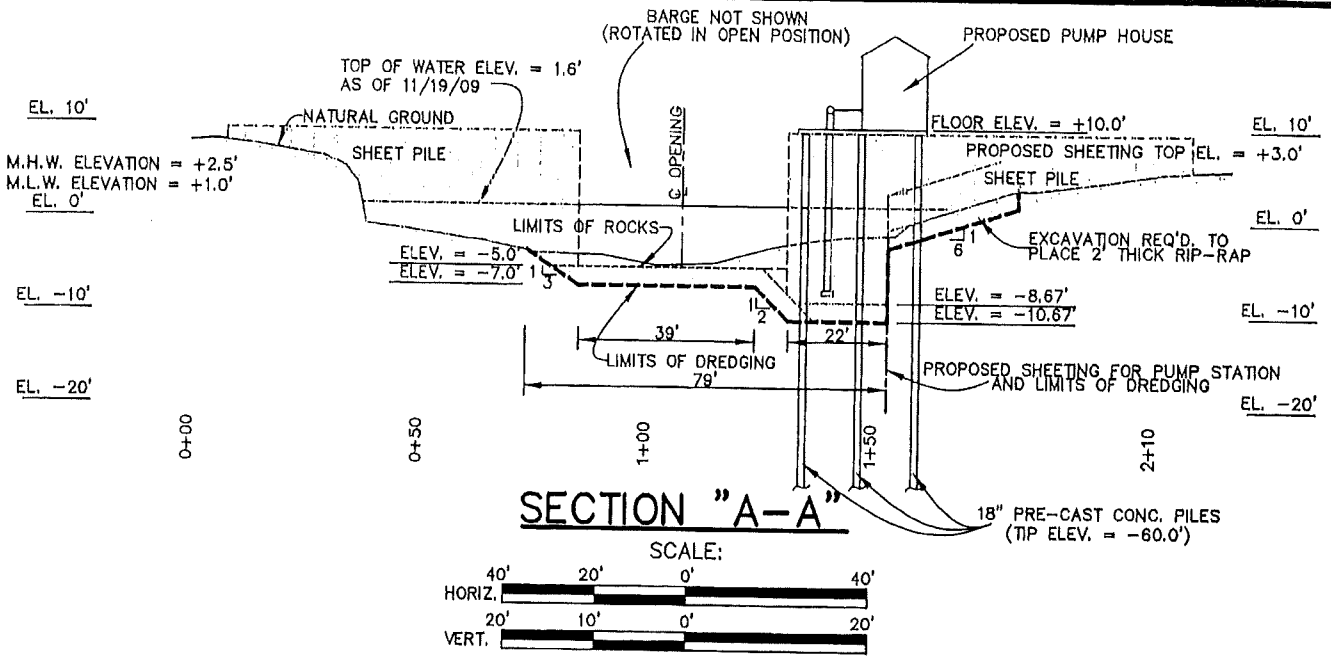

REVISED: JANUARY 28, 2013 TO SHOW SHEET NUMBER CHANGE AND ADDED BARGE LOCATIONS FOR FINAL PROJECT.
 REVISED: JANUARY 29, 2013 TO ADDRESS ADDITIONAL COMMENTS FROM O.C.M.

PROPOSED: FRANKLIN CANAL FLOOD PROTECTION SYSTEM
ON: FRANKLIN CANAL
SITUATED IN: SECTION 63 T14S-R9E, ST. MARY PARISH, LOUISIANA
APPLICATION BY: ST. MARY LEVEE DISTRICT
DATE: JANUARY 2, 2013
SHEET 4 OF 5

EL. 10'

M.H.W. ELEVATION = +2.5'
M.L.W. ELEVATION = +1.0'
EL. 0'

EL. -10'

EL. -20'

PROPOSED SHEETING TOP EL. = +9.50'

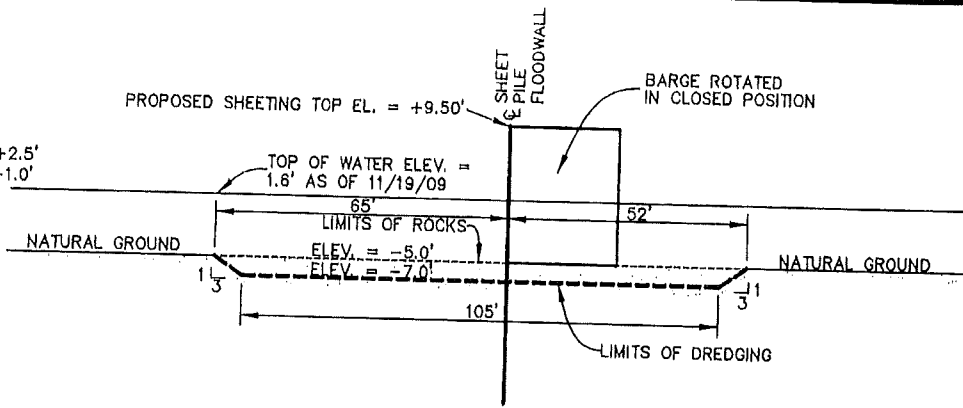

EL. 10'

EL. 0'

EL. -10'

EL. -20'

SECTION "C-C"

SCALE:

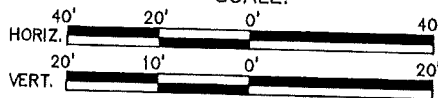

EL. 10'

TOP OF WATER ELEV. = 1.6' AS OF 11/19/09
M.H.W. ELEVATION = +2.5'
M.L.W. ELEVATION = +1.0'
EL. 0'

EL. -10'

EL. -20'

PROPOSED PUMP HOUSE
NOT SHOWN FOR CLARITY

PUMP STRUCTURE

FLOOR ELEV. = +10.0'

PROPOSED SHEETING TOP EL. = +9.50'

SHEET PILE FLOODWALL

BARGE ROTATED
IN OPEN POSITION

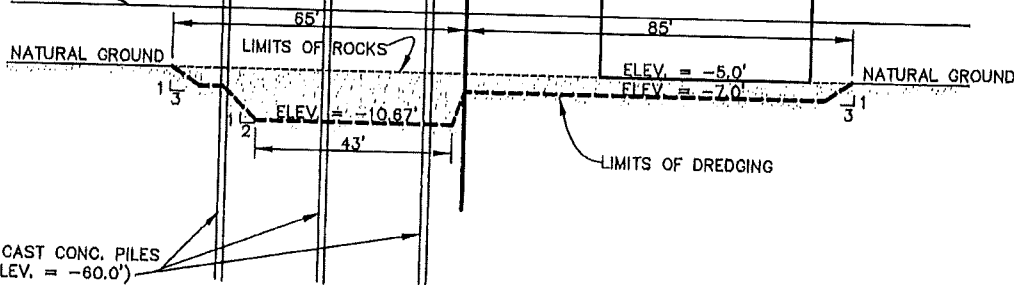

EL. 10'

EL. 0'

EL. -10'

EL. -20'

SECTION "D-D"

SCALE:

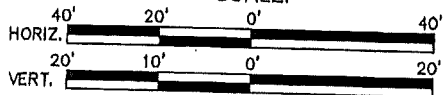

REVISED: JANUARY 28, 2013 TO SHOW SHEET NUMBER CHANGE AND ADDED BARGE LOCATIONS FOR FINAL PROJECT.

REVISED: JANUARY 29, 2013 TO ADDRESS ADDITIONAL COMMENTS FROM O.C.M.

PROPOSED: FRANKLIN CANAL FLOOD PROTECTION SYSTEM
ON: FRANKLIN CANAL
SITUATED IN: SECTION 63 T14S-R9E, ST. MARY PARISH, LOUISIANA
APPLICATION BY: ST. MARY LEVEE DISTRICT
DATE: JANUARY 2, 2013

SHEET 5 OF 5

APPENDIX E
CLARIFICATION, CHANGE ORDER, AND ACCEPTANCE

FRANKLIN CANAL FLOOD PROTECTION SYSTEM
PHASE II – PUMP STATION (TV-52)
Interpretation or Clarification by Engineer
Number (____)

DATE:

SUBJECT:

SUMMARY OF MATTER BY CONTRACTOR

INTERPRETATION OR CLARIFICATION OF MATTER BY ENGINEER

CHANGE ORDER NO. ____

OWNER: State of Louisiana, Coastal Protection & Restoration Authority

CONTRACTOR PROJECT: Franklin Canal Flood Protection System Phase II - Pump Station (TV-52)

FILE NO: _____

SOLICITATION NO: _____

ENGINEER: _____

The following changes are hereby proposed to be made to the Contract Documents:

•

Description: See attached summary.

Attachments (list documents supporting change):

•

Change in Contract Price		Change in Contract Time	
Original Contract Price		Original Contract Time (calendar days)	
Net Increase / (Decrease) from previous Change Orders		Net Increase / Decrease from previous Change Orders (days)	
Contract Price prior to this Change Order		Contract Time prior to this Change Order (calendar days)	
Net Increase / (Decrease) of this Change Order		Net Increase (Decrease) of this Change Order (days)	
Contract Price with this Change Order		Contract Time with this Change Order (calendar days)	

RECOMMENDED:

By: _____

Engineer

Date: _____

RECOMMENDED:

By: _____

CPRA Construction

Manager

Date: _____

ACCEPTED:

By: _____

Contractor

Date: _____

Franklin Canal Flood Protection System Phase II - Pump Station (TV-52)

FILE NO: _____, PURCHASE ORDER NO: _____

SUMMARY OF CHANGE ORDER NO: _____

ITEM NO.	DESCRIPTION	UNIT	ORIGINAL QUANTITY	ADJUSTED QUANTITY	UNIT PRICE	AMOUNT OVERRUN	AMOUNT UNDERRUN
Net Increase of this Change Order							

Justification:

-

No additional contract time is requested to accomplish the work for the change order.

❖ NOT FOR RECORDATION PURPOSES ❖

RECOMMENDATION OF ACCEPTANCE

TO: Coastal Protection and Restoration Authority
450 Laurel Street, Suite 1501
Baton Rouge, LA 70801

FROM: _____

Design Firm Name and Address

DATE: _____

PROJECT NAME & NUMBER: _____

SITE CODE: _____ STATE ID: _____ CFMS: _____

CONTRACTOR: _____

ORIGINAL CONTRACT AMOUNT: \$ _____

FINAL CONTRACT AMOUNT: \$ _____

DATE OF ACCEPTANCE: _____

CONTRACT DATE OF COMPLETION: _____

NUMBER OF DAYS (OVERRUN) (UNDERRUN) (As of Acceptance Date) _____

LIQUIDATED DAMAGES PER DAY STIPULATED IN CONTRACT \$ _____

VALUE OF PUNCH LIST \$ _____
(Attach punch list)

Signed: _____
DESIGNER

FOR USE OF PROJECT MANAGER:

Signed: _____
PROJECT MANAGER

❖ NOT FOR RECORDATION PURPOSES ❖

APPENDIX F
LAND RIGHTS MEMORANDUM

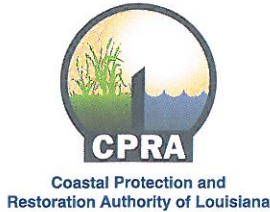

State of Louisiana

BOBBY JINDAL
GOVERNOR

MEMORANDUM

June 13, 2012

TO: Robert Routon
Chief, Project Management Division

FROM: Jim Altman *JA*
Land Manager

RE: Notice of Landrights Completion
Franklin Canal Structure, Levee Improvements and Pump Station Project TV-52
St. Mary Parish, Louisiana

In reference to the subject project this letter will confirm that all of the necessary landrights have been acquired in order to move forward with advertising, selection of a construction contractor and construction of the project.

The attached agreements, secured from all necessary landowners, provide the necessary landrights for the project to be constructed.

This information will only be sent electronically unless otherwise requested. Please let me know if you have any questions.

c (w/ enclosures): Will Norman – Project Manager, CDM Smith, Baton Rouge
Tim Harper, CPRA Project Manager
Angela Thomas, CPRA Land Specialist 4
Cynthia Wallace, CPRA, Chief Landrights

Attachments: 6

F:\users\LAND\Projects\Community Development Block Grant Projects (CDBG)\Franklin Canal TV-52 Landrights Completion Ltr.